

Important safety instructions

Your projector is designed and tested to meet the latest standards for safety of information technology equipment. However, to ensure safe use of this product, it is important that you follow the instructions mentioned in this manual and marked on the product.

General safety instruction

1. Do not look straight at the projector lens during operation. The intense light beam may damage your eyes.
2. Always open the lens shutter or remove the lens cap when the projector light source is on.
3. In some countries, the line voltage is NOT stable. This projector is designed to operate safely within a mains voltage between 100 to 240 volts AC, but could fail if power cuts or surges of ± 10 volts occur. In areas where the mains voltage may fluctuate or cut out, it is recommended that you connect your projector through a power stabilizer, surge protector or uninterruptible power supply (UPS).
4. Do not block the projection lens with any objects when the projector is under operation as this could cause the objects to become heated and deformed or even cause a fire. To temporarily turn off the light source, press **BLANK** on the remote control.
5. Do not place this product on an unstable cart, stand, or table. The product may fall, sustaining serious damage.
6. Do not attempt to disassemble this projector. There are dangerous high voltages inside which may cause death if you should come into contact with live parts.
Under no circumstances should you ever undo or remove any other covers. Refer servicing only to suitably qualified professional service personnel.
7. Do not place this projector in any of the following environments.
 - Space that is poorly ventilated or confined. Allow at least 50 cm clearance from walls and free flow of air around the projector.
 - Locations where temperatures may become excessively high, such as the inside of a car with all windows rolled up.
 - Locations where excessive humidity, dust, or cigarette smoke may contaminate optical components, shortening the projector's life span and darkening the image.
 - Locations near fire alarms
 - Locations with an ambient temperature above 40°C / 104°F
 - Locations where the altitudes are higher than 3000 m (10000 feet).
8. Do not block the ventilation holes.
 - Do not place this projector on a blanket, bedding or any other soft surface.
 - Do not cover this projector with a cloth or any other item.
 - Do not place inflammables near the projector.

If the ventilation holes are seriously obstructed, overheating inside the projector may result in a fire.

9. Do not step on the projector or place any objects upon it. Besides probable physical damage to the projector, doing so may result in accidents and possible injury.
10. Do not place liquids near or on the projector. Liquids spilled into the projector may cause it to fail. If the projector does become wet, disconnect it from the power supply's wall socket and call BenQ to have the projector serviced.

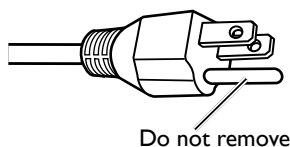

This equipment has a three-pin grounding-type power plug. Do not remove the grounding pin. As a safety feature, this plug will only fit a grounding-type power outlet. If you are unable to fit the plug into the outlet, contact an electrician.

Notice on laser

Caution – use of controls or adjustments or performance of procedures other than those specified herein may result in hazardous radiation exposure.

Do not point laser or allow laser light to be directed or reflected toward other people or reflective objects.

Direct or scattered light can be hazardous to eyes and skin.

There is a potential hazard of eye exposure to laser radiation if the included instructions are not followed.

Do not allow to look into the projector beam at any distance from the projector. An adult should supervise the children to prevent exposure risks.

Check that there is no one looking at the lens, when using the remote control for starting the projector.

Do not look at the projected light using optical devices(binoculars, telescopes, magnifying glasses, reflectors, etc).

Laser class

This Laser Product is designated as Class I and CONSUMER LASER PRODUCT: EN 50689:2021 during all procedures of operation and complies with IEC 60825-1:2014 and EN 60825-1:2014/A11:2021

Laser parameters

Wavelength	449nm - 461nm (Blue)
Mode of operation	Pulsed, due to frame rate
Pulse width	1.15ms
Pulse repetition rate	120Hz
Maximum laser energy	0.76mj
Total internal power	>100w
Apparent source size	>10mm, at lens stop
Divergence	>100 mili Radian

Label instruction

Below drawing show the label's location.

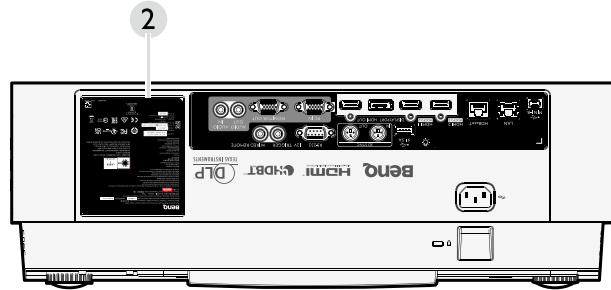
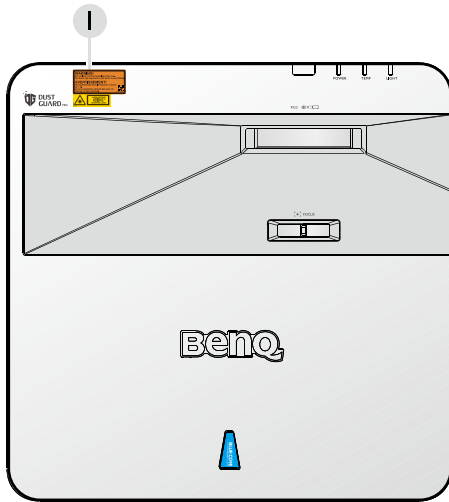

1. Laser warning label



2. Spec label

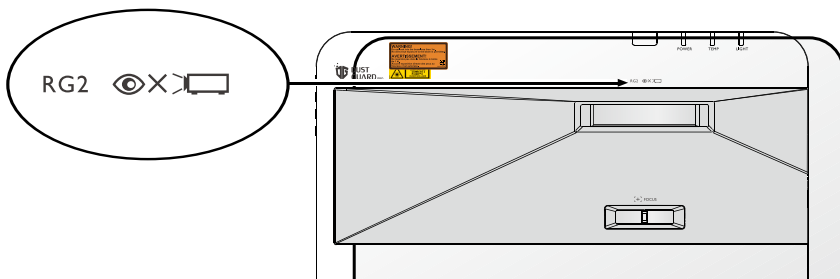
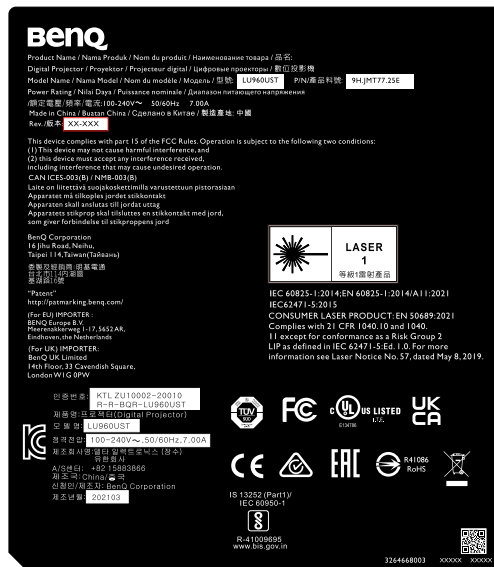

Caution:

As with any bright light source, do not stare into the beam, RG2 IEC 62471-5:2015
Possibly hazardous optical radiation emitted from this product.
Do not stare at operating light source. May be harmful to the eyes.

Prepare for installation

Focus adjustment

The high clarity projection lens is thermally affected by the light from the light source; thus, the focus is unstable for a short period immediately after the power is turned on. Please wait at least 15 minutes of continuous projection before adjusting the focus.

Focus adjustment

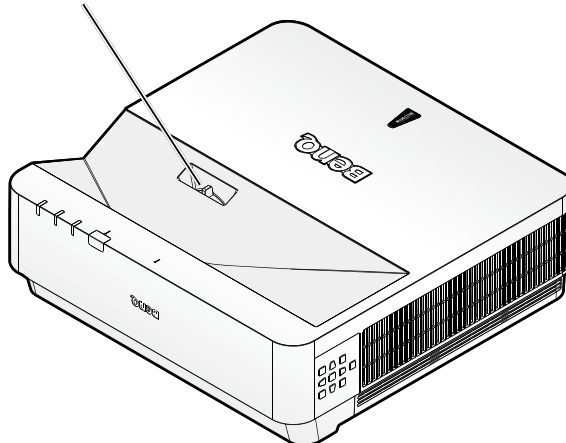

Cooling notice

Allow at least 50 cm (19.7 inch) for clearance around the exhaust vent. Make sure no objects block air inlet within 50 cm (19.7 inch).

Keep the outlet at least 1 m away from the inlets of other projectors.

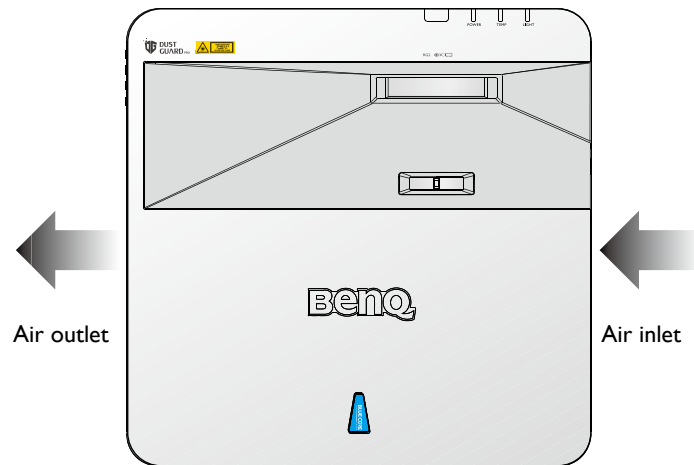

- The projector can be installed at following angles:
360-degree projection

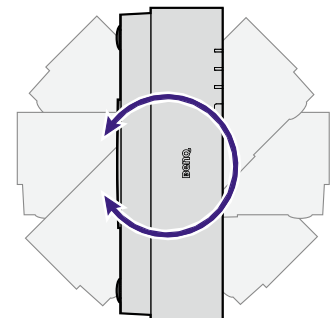
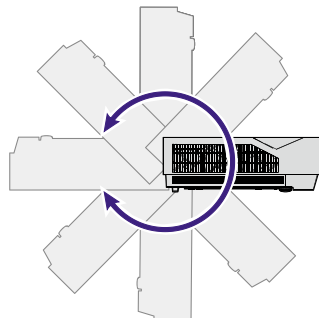
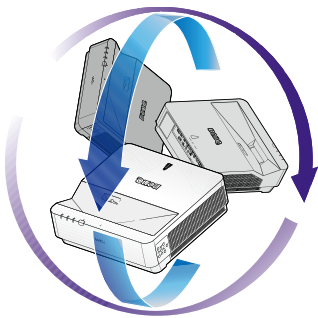

! Caution:

Installation of the projector should be performed carefully. Incomplete or improper installation may cause the projector to fall, resulting in personal injury or property damage.

- Allow at least 50 cm of clearance around the exhaust vent.

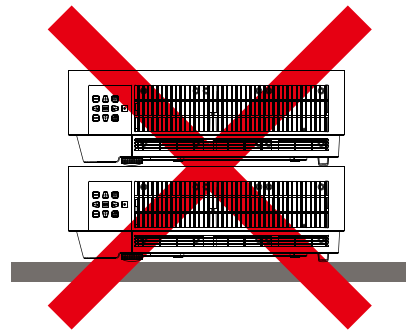
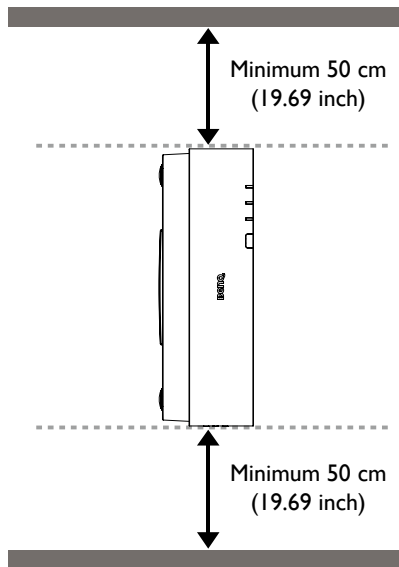
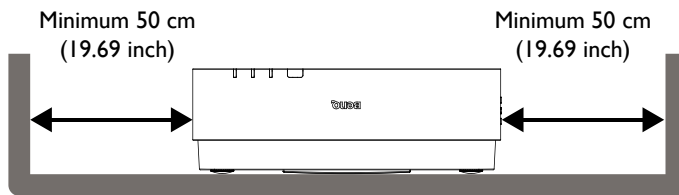

- Ensure that the air intake vents do not recycle hot air from the exhaust vent.
- When operating in an enclosed space, make sure that the surrounding air temperature does not exceed the projector's operating temperature and that the air intake and exhaust vents are unobstructed.
- All enclosures should pass a certified thermal evaluation to ensure that the projector does not recycle exhaust air. Recycling exhaust air may cause the projector to shutdown even if the ambient temperature is within the acceptable operating temperature range.