

StarBoard

IFPD Mobile Stand IBD3110

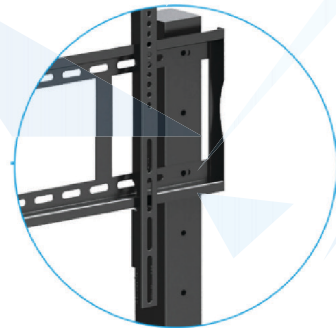

Height Adjustable Design

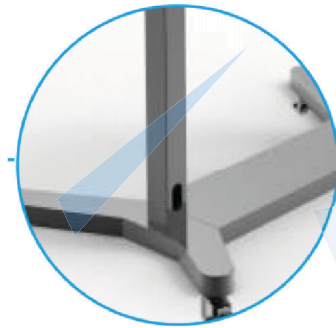

Hidden Cable Routing System

IFPD sizes
42" - 86"

Max. VESA
800X500mm

Max. Bearing
90kg

Parameters

Applicable Size	42" - 86"
Min. VESA Holes	100x100m
Max. VESA Holes	800x500m
Max. Bearing Weight	80kg
Color	Black

Other Features

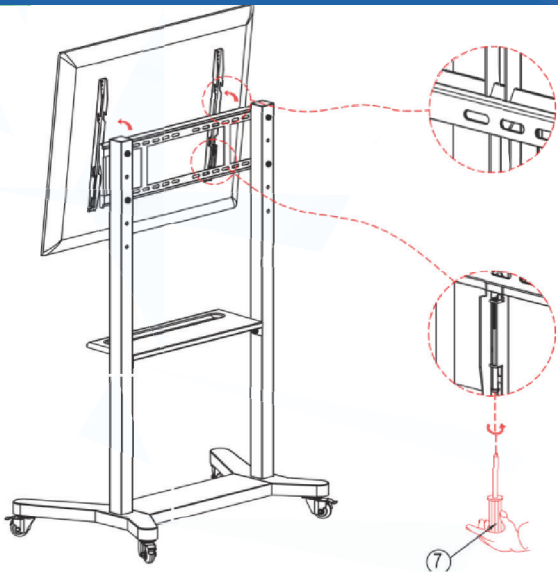

Security hook and screw to lock IFPD from falling down

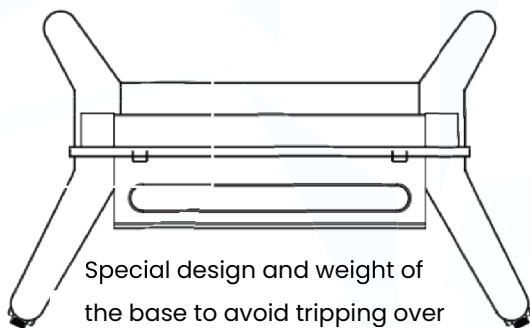

Special design and weight of the base to avoid tripping over

