













B&W OUTDOOR.CASE TYPE 5500

Artikelnummer: 5500/Y/SI

	zwei Ösen für Schlösser (Ø 7 mm)		staubdicht
	wasserdicht nach IP67		30 Jahre Garantie
	extrem robust		gummierter Tragegriff
	leicht zu öffnende Schlösser		stapelbar
	temperaturstabil		flugtauglich

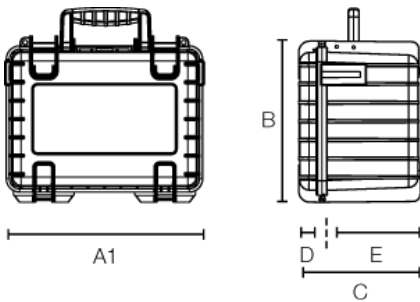

A (A1):	495 mm
B:	365 mm
C:	315 mm
A (A1) innen:	430 mm
B innen:	300 mm
C innen:	300 mm
D (Deckel) innen:	45 mm
E (Boden) innen:	255 mm

Produkteigenschaften

Innenausstattung	leer vorgestanzter Würfelschaum (SI) variable Facheinteilung (RPD)
Zertifikate	UN 3090/91 UN 3480/81 ATA 300 MIL-STD-801G IP67 STANAG 4280 DEF STAN 81-41
Material	PP
Volumen (L)	37,9



B&W International GmbH | Junkendiek 5 | D-49479 Ibbenbüren
Fon + 49 (0) 54 51 / 89 46-0 | Fax + 49 (0) 54 51 / 89 46-444 | info@b-w-international.com

www.b-w-international.com