











B&W OUTDOOR.CASE TYPE 3000

Artikelnummer: 3000/B/SI

| | | | |
|---|----------------------------------|---|-----------------------|
|  | zwei Ösen für Schlösser (Ø 7 mm) |  | staubdicht |
|  | wasserdicht nach IP67 |  | 30 Jahre Garantie |
|  | extrem robust |  | gummierter Tragegriff |
|  | leicht zu öffnende Schlösser |  | stapelbar |
|  | temperaturstabil |  | flugtauglich |

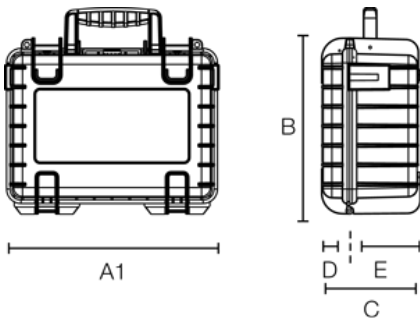

| | |
|-------------------|---------------|
| A (A1): | 365 mm |
| B: | 295 mm |
| C: | 170 mm |
| A (A1) innen: | 330 mm |
| B innen: | 235 mm |
| C innen: | 150 mm |
| D (Deckel) innen: | 40 mm |
| E (Boden) innen: | 110 mm |

Produkteigenschaften

| | |
|------------------|--|
| Innenausstattung | leer vorgestanzter Würfelschaum (SI) variable Facheinteilung (RPD) |
| Zertifikate | UN 3090/91 UN 3480/81 ATA 300 MIL-STD-801G IP67 STANAG 4280 DEF STAN 81-41 |
| Material | PP |
| Volumen (L) | 11,7 |



B&W International GmbH | Junkendiek 5 | D-49479 Ibbenbüren
Fon + 49 (0) 54 51 / 89 46-0 | Fax + 49 (0) 54 51 / 89 46-444 | info@b-w-international.com

www.b-w-international.com