













## B&W OUTDOOR.CASE TYPE 1000

Artikelnummer: 1000/B/SI

|   |                                    |   |                       |
|---|------------------------------------|---|-----------------------|
|  | zwei Ösen für Schlösser (Ø 4,5 mm) |  | staubdicht            |
|  | wasserdicht nach IP67              |  | 30 Jahre Garantie     |
|  | extrem robust                      |  | gummierter Tragegriff |
|  | leicht zu öffnende Schlösser       |  | stapelbar             |
|  | temperaturstabil                   |  | flugtauglich          |

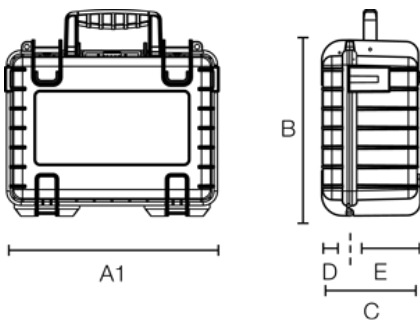

|                   |               |
|-------------------|---------------|
| A (A1):           | <b>270 mm</b> |
| B:                | <b>215 mm</b> |
| C:                | <b>105 mm</b> |
| A (A1) innen:     | <b>250 mm</b> |
| B innen:          | <b>175 mm</b> |
| C innen:          | <b>95 mm</b>  |
| D (Deckel) innen: | <b>25 mm</b>  |
| E (Boden) innen:  | <b>70 mm</b>  |

### Produkteigenschaften

|                  |  |
|------------------|--|
| Innenausstattung | leer vorgestanzter Würfelschaum (SI) variable Facheinteilung (RPD)               |
| Zertifikate      | UN 3090/91 UN 3480/81 ATA 300<br>MIL-STD-801G IP67 STANAG<br>4280 DEF STAN 81-41 |
| Material         | PP   |
| Volumen (L)      | 4,1  |



B&W International GmbH | Junkendiek 5 | D-49479 Ibbenbüren  
Fon + 49 (0) 54 51 / 89 46-0 | Fax + 49 (0) 54 51 / 89 46-444 | info@b-w-international.com

[www.b-w-international.com](http://www.b-w-international.com)