

# AI Auto Tracking PTZ Camera

PTC310/ PTC310H /PTC310U

PTC330/ PTC330U

\*NDI model:PTC310N/PTC310UN/PTC330N

## User Manual



## **FCC NOTICE (Class A)**



This device complies with Part 15 of the FCC Rules. The operation is subject to the following two conditions: (1) this device may not cause harmful interference, and (2) this device must accept any interference received, including interference that may cause undesired operation.

NOTE- This equipment has been tested and found to comply with the limits for a Class A digital device, pursuant to Part 15 of the FCC Rules. These limits are designed to provide reasonable protection against harmful interference in a residential installation. This equipment generates uses and can radiate radio frequency energy and, if not installed and used in accordance with the instructions, may cause harmful interference to radio communications. However, there is no guarantee that interference will not occur in a particular installation. If this equipment does cause harmful interference to radio or television reception, which can be determined by turning the equipment off and on, the user is encouraged to try to correct the interference by one or more of the following measures:

- Reorient or relocate the receiving antenna.
- Increase the separation between the equipment and receiver.
- Connect the equipment into an outlet on a circuit different from that to which the receiver is connected.
- Consult the dealer or an experienced radio/television technician for help.

## **Class A ITE**

Class A ITE is a category of all other ITE which satisfies the class A ITE limits but not the class B ITE limits. Such equipment should not be restricted in its sale but the following warning shall be included in the instructions for use:

Warning - This is a class A product. In a domestic environment, this product may cause radio interference in which case the user may be required to take adequate measures.

## **European Community Compliance Statement (Class A)**



This product is herewith confirmed to comply with the requirements set out in the Council Directives on the Approximation of the laws of the Member States relating to Electromagnetic Compatibility Directive 2014/30/EU.

Warning - This is a Class A product. In a domestic environment, this product may cause radio interference in which case the user may be required to take adequate measures to correct this interference.

## **DISCLAIMER**

No warranty or representation, either expressed or implied, is made with respect to the contents of this documentation, its quality, performance, merchantability, or fitness for a particular purpose. Information presented in this documentation has been carefully checked for reliability; however, no responsibility is assumed for inaccuracies. The information contained in this documentation is subject to change without notice.

In no event will AVer Information Inc. be liable for direct, indirect, special, incidental, or consequential damages arising out of the use or inability to use this product or documentation, even if advised of the possibility of such damages.

## **TRADEMARKS**

“AVer” is a trademark owned by AVer Information Inc. Other trademarks used herein for description purpose only belong to each of their companies.

## **COPYRIGHT**

©2021 AVer Information Inc. All rights reserved.

All rights of this object belong to AVer Information Inc. Reproduced or transmitted in any form or by any means without the prior written permission of AVer Information Inc. is prohibited. All information or specifications are subject to change without prior notice.

## **NOTICE**

SPECIFICATIONS ARE SUBJECT TO CHANGE WITHOUT PRIOR NOTICE. THE INFORMATION CONTAINED HEREIN IS TO BE CONSIDERED FOR REFERENCE ONLY.

## **Remote Control Battery Safety Information**

- Store batteries in a cool and dry place.
- Do not throw away used batteries in the trash. Properly dispose of used batteries through specially approved disposal methods.
- Remove the batteries if they are not in use for long periods of time. Battery leakage and corrosion can damage the remote control. Dispose of batteries safely and through approved disposal methods.
- Do not use old batteries with new batteries.
- Do not mix and use different types of batteries: alkaline, standard (carbon-zinc) or rechargeable (nickel-cadmium).
- Do not dispose of batteries in a fire.
- Do not attempt to short-circuit the battery terminals.

## **CAUTION**

- Risk of explosion if battery is replaced by an incorrect type.
- Dispose of used batteries in a safe and proper manner.

## WARNING

- To reduce the risk of fire or electric shock, do not expose this appliance to rain or moisture. Warranty will be void if any unauthorized modifications are done to the product.
- Do not drop the camera or subject it to physical shock.
- Use the correct power supply voltage to avoid the damaging camera.
- Do not place the camera where the cord can be stepped on as this may result in fraying or damage to the lead or the plug.
- Hold the bottom of the camera with both hands to move the camera. Do not grab the lens or lens holder to move the camera.

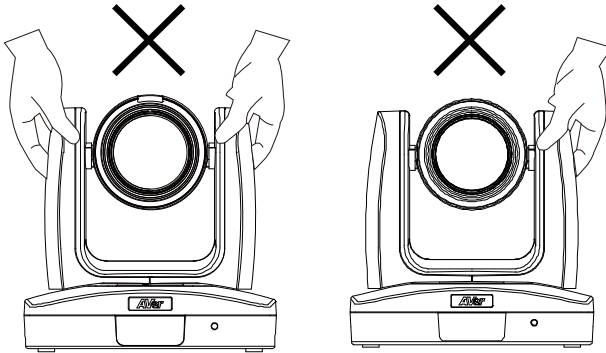

**OK**

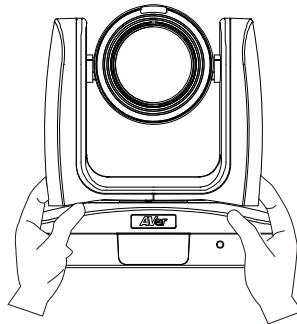

# Contents

Package Contents.....	1
Product Introduction.....	2
Sources .....	2
Overview .....	2
LED Indicator.....	3
Pan and Tilt Angle .....	3
Dimension .....	4
Device Connection .....	5
Video Output Connection .....	6
RS232 and RS422 Connection .....	7
Audio Input Connection .....	11
PoE Connection .....	11
Install Cable Fixing Plate .....	13
Ceiling installation .....	14
Installation for Auto Tracking Performance .....	15
Remote Control .....	16
Setup the Camera.....	18
OSD Menu.....	18
Setup IP Address of the Camera .....	18
Static IP .....	18
DHCP .....	19
OSD Tree .....	20
Camera.....	20

Advanced Setting.....	21
Video Output.....	21
Network .....	21
System.....	22
Web Setup.....	23
Using the AVer IPCam Utility to Find the Camera.....	23
Using AVer PTZ Management Software to Find the Camera.....	24
Make a Connection to the Camera via Browser .....	25
Live View .....	26
Pan-Tilt-Zoom Control.....	26
Focus.....	27
Manual Pan-Tile-Zoom and Preset Speed Adjustment .....	27
Preset Setting .....	28
Tracking Control .....	28
Click Tracking Function.....	29
Camera Settings.....	30
Exposure .....	30
Image Process .....	30
Video & Audio.....	31
Get 4K (2160p) output .....	31
Network .....	34
RTMP Setting .....	34
Using RTSP Connect to Camera .....	35
SRT Stream.....	36
Tracking Setting.....	38

Presenter Mode .....	38
Zone Mode .....	40
Hybrid Mode .....	42
Quick Setup for Tracking.....	44
Presenter Mode.....	44
Zone Mode .....	44
System .....	45
Upgrade Firmware .....	46
VISCA RS232 Command Table .....	47
Visca over IP Settings .....	48
CGI command .....	49
Specification.....	51
PTC310 .....	51
PTC310H.....	54
PTC310N.....	57
PTC310U.....	61
PTC310UN .....	64
PTC330 .....	68
PTC330N.....	71
PTC330U.....	75

# Package Contents

## Package Contents



Camera unit

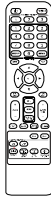

Remote control



Cable ties(x5)

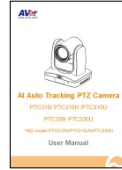

Quick Start Guide

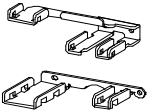

Cable Fixing plates(x2)



M2 x 4mm Screw(x4)

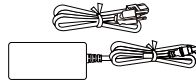

Power adapter & Power cord



1/4"-20L=6.5mm Screw(x3)

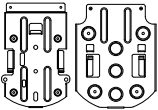

Ceiling mount bracket(x2)



M3 x 6mm Screw(x3)

\*The power cord will vary depending on the standard power outlet of the country where it is sold.

## Optional accessory

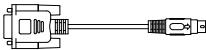

RS232 Din8 to D-Sub9 Cable



RS232 In/Out Y Cable

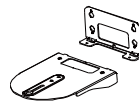

Wall mount bracket

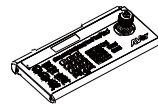

Camera Controller (CL01)

\* For detail on optional accessories, consult your local dealer.



# Product Introduction

## Sources

PTC300 Intro Video

<https://www.youtube.com/watch?v=j25xQbkSmPc>

PTC300 Series Feature Video

<https://www.youtube.com/watch?v=VJh1m5RWhLw>

AVer Tech (Setup)

[https://www.youtube.com/channel/UC8rQt7Pe3\\_4Rh-K4p1eXfNw](https://www.youtube.com/channel/UC8rQt7Pe3_4Rh-K4p1eXfNw)

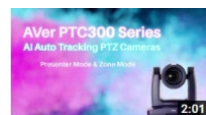

## Overview

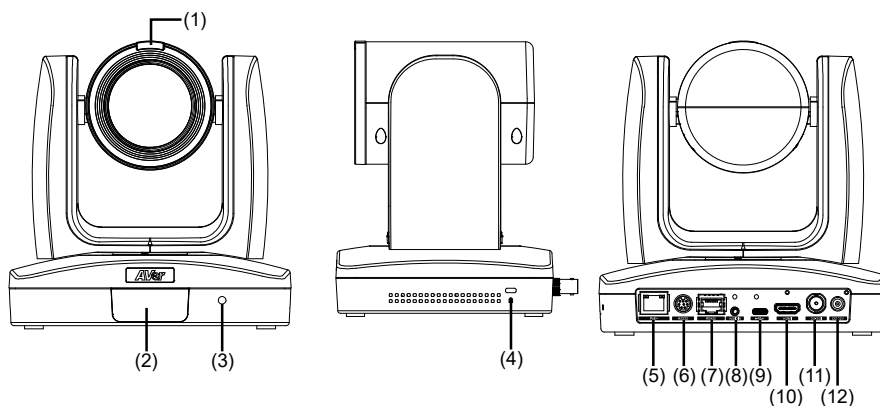

(1) Tally Lamp (*1)	(5) PoE+ IEEE 802.3AT	(9) USB 3.0 Port (Type C)
(2) IR Sensor	(6) RS232 Port	(10) HDMI Port
(3) Power Indicator	(7) RS422 Port	(11) 3G-SDI Port (*2)
(4) Kensington Lock	(8) Audio In	(12) DC Power Jack

\*1: Line input level: 1Vrms (max.).

Mic input level: 50mVrms (max.); Supplied voltage: 2.5V

\*2: This feature (3G-SDI) is not supported on PTC310H & PTC310HN.

## LED Indicator

LED	Status
Blue(Solid)	Normal Operation
Blue(Blinking)	Auto Tracking On
Orange(Blinking)	Camera Initialization
Orange(Solid)	Standby
Red(Blinking)	FW Updating

## Pan and Tilt Angle

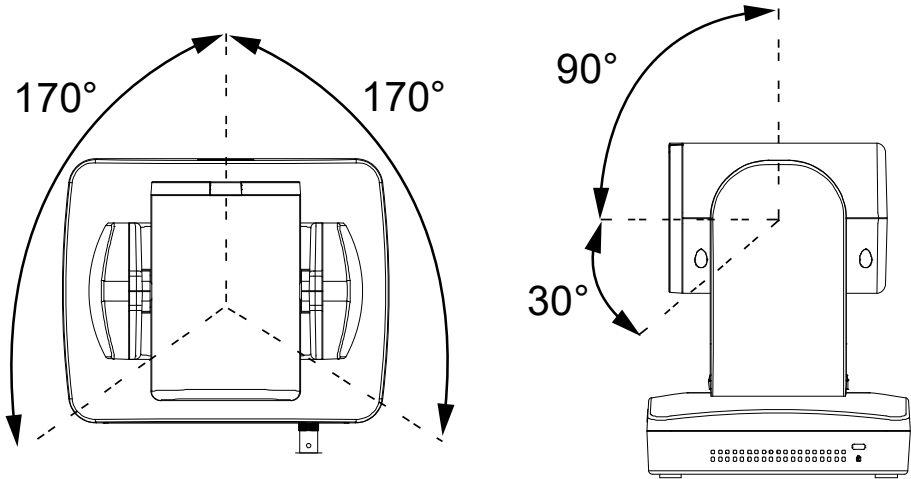

# Dimension

Unit: mm

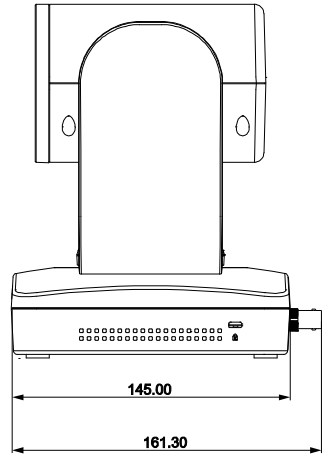
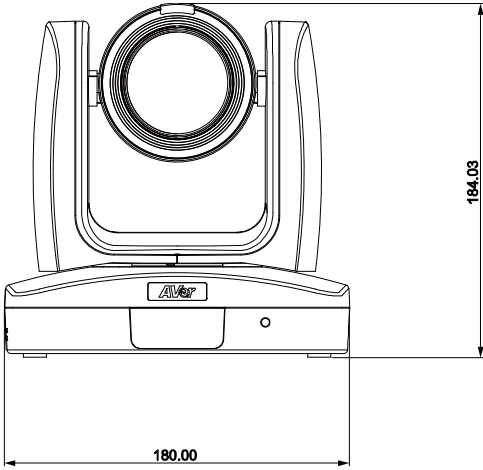

# Device Connection

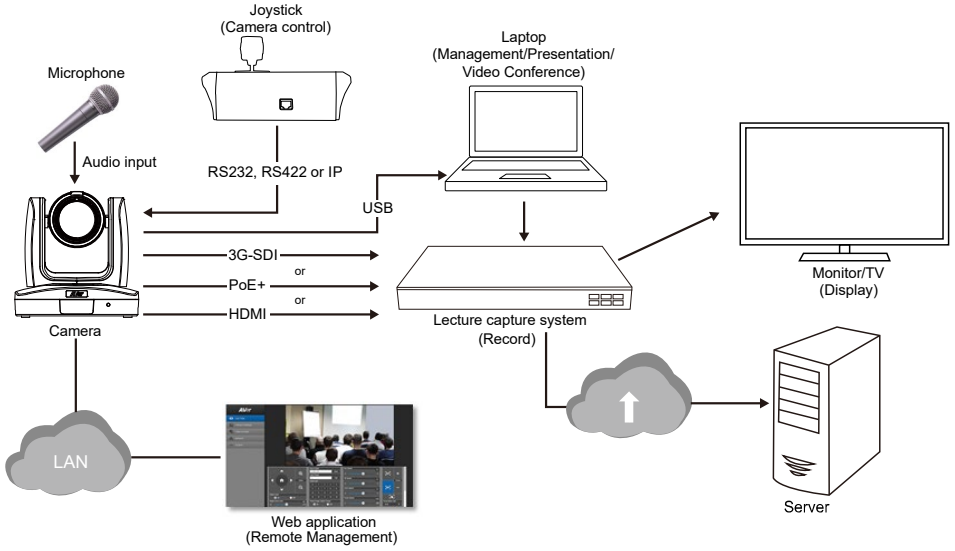

## Video Output Connection

### ■ HDMI

Use the HDMI cable to connect with monitor or TV for video output.

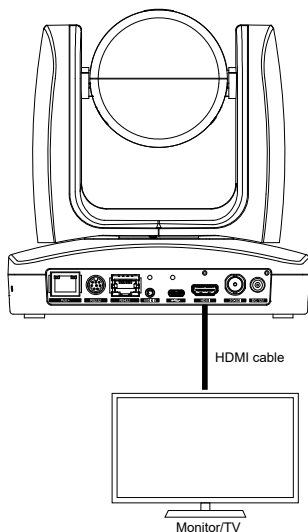

### ■ 3G-SDI

Connect to 3G-SDI monitor for video output. (This feature "3G-SDI" is not supported on PTC310H & PTC310HN.)

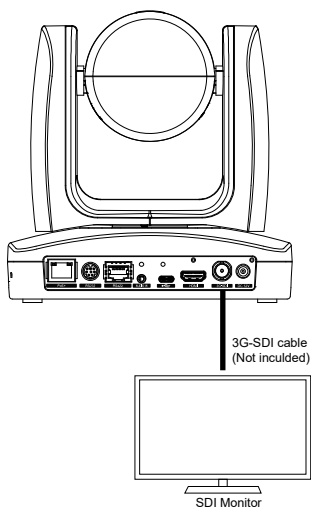

**[Note]** HDMI and 3G-SDI monitors can be connected to camera and output live video simultaneously; Assuming HDMI monitor is well connected before the camera turned on, the OSD menu will be displayed on HDMI monitor in default."

## RS232 and RS422 Connection

Connect through the RS232 or RS422 for camera control.

### ■ RS232

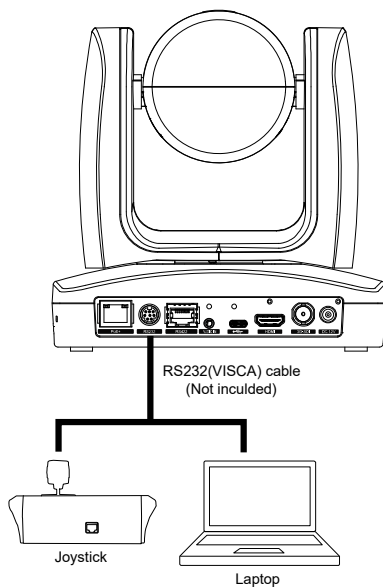

● **RS232 Port Pin Definition**

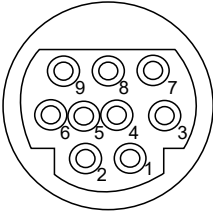

Function	Mini DIN9 PIN #	I/O Type	Signal	Description
VISCA IN	1	Output	DTR	Data Terminal Ready
	2	Input	DSR	Data Set Ready
	3	Output	TXD	Transmit Data
	6	Input	RXD	Receiver Data
VISCA OUT	7	Output	DTR	Data Terminal Ready
	4	Input	DSR	Data Set Ready
	8	Output	TXD	Transmit Data
	9	Input	RXD	Receiver Data
	5	---	---	Not connect

● **RS232 mini DIN9 to mini DIN8 Cable Pin Definition**

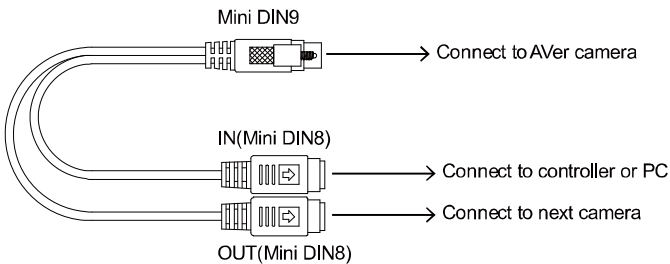

## Mini DIN8 Cable Pin Definition

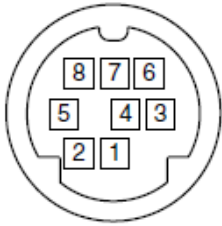

No.	Signal
1	DTR
2	DSR
3	TXD
4	GND
5	RXD
6	GND
7	NC
8	NC

## ● Din8 to D-Sub9 Cable Pin Definition

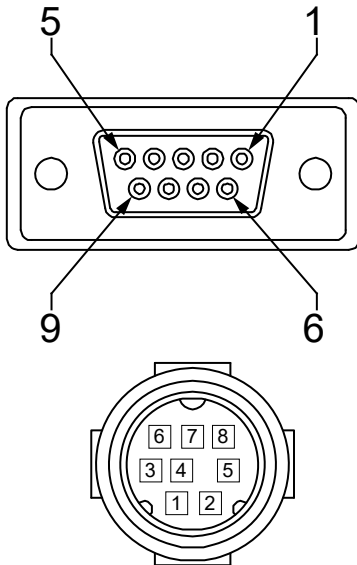



■ RS422

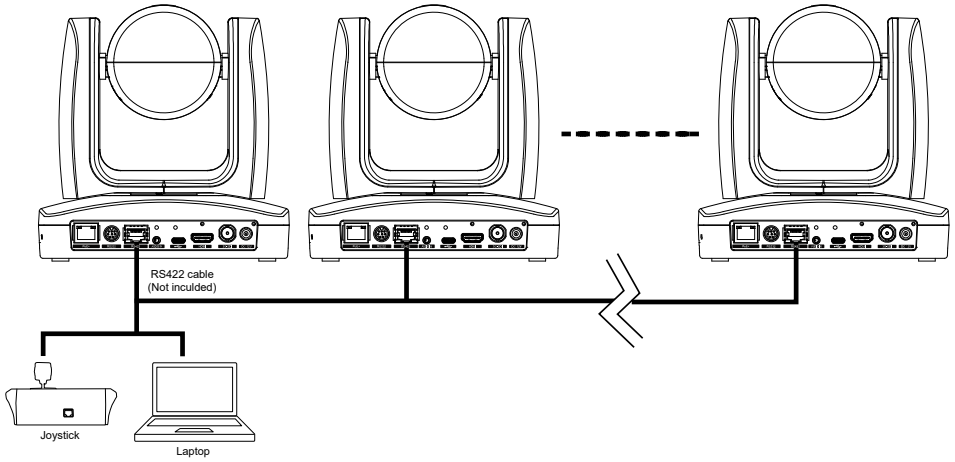

**[Note]** Use cat5e splitter for multi-camera connection.

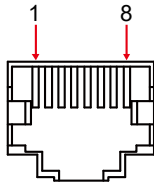

RS422 Pin			
No.	Pin	No.	Pin
1	TX-	5	TX+
2	TX+	6	RX+
3	RX-	7	RX-
4	TX-	8	RX+

Cat5e splitter pin assignment:

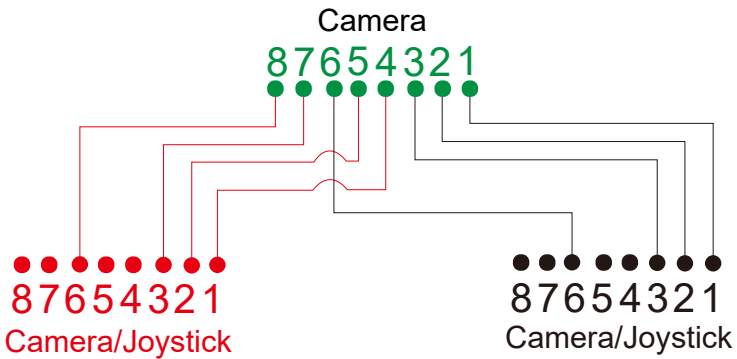

## Audio Input Connection

Connect the audio device for audio receiving.

### [Note]

- Line input level: 1Vrms (max.).
- Mic input level: 50mVrms (max.); Supplied voltage:2.5V.

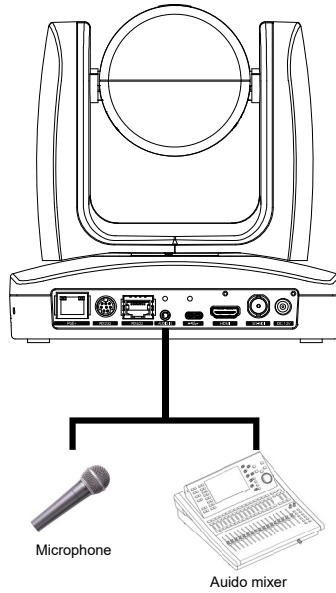

## PoE Connection

Connect the camera to the router or switch through the PoE+ port.

**[Note]** Only support IEEE 802.3AT PoE+ standard.

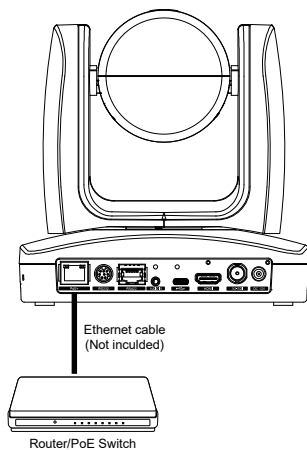

## Install Cable Fixing Plate

- ① Secure the cable fixing plate to the camera with screws.  
Screw: 4screws, M2 x 4mm(Included in the package)

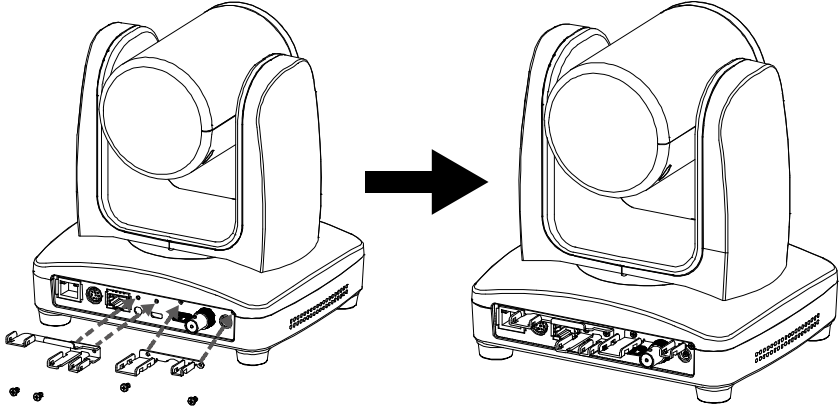

- ② Plug-in cables.

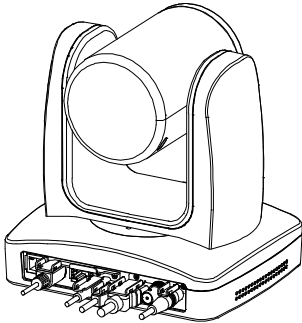

- ③ Using cable ties to secure the cable and cable fixing plate.

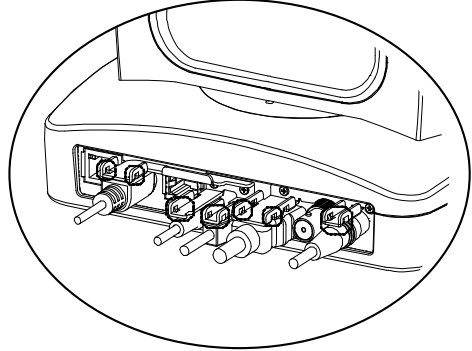

## Ceiling installation

1. Secure the mount bracket on the ceiling.  
Screw: 4 screws, M4 x 10mm(Not Included in the package)

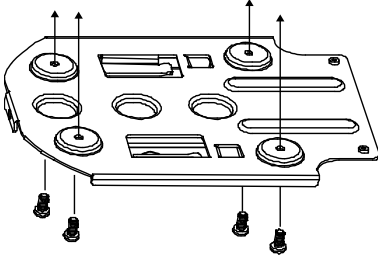

2. Install the mount bracket on the camera.  
Screw: 3 screw , 1/4"-20 L=6.5mm(Included in the package)

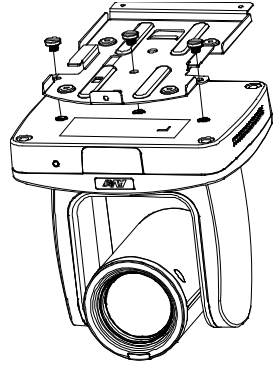

3. Slide the mount bracket with the camera into the mount bracket which secured on the ceiling.

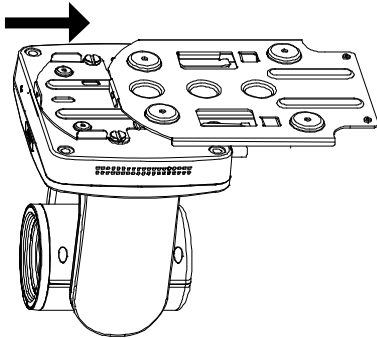

4. Secure the camera with screws.  
Screw: 3 screws, M3 x 6mm( Not Included in the package)

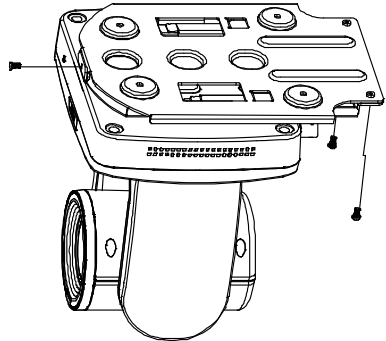

**[Note]** Connects necessary cables after sliding the camera into the mount bracket.

## Installation for Auto Tracking Performance

- **Maximum/Minimum distance from the camera to tracking target**

	Upper body tracking	Full body tracking
PTC310	1.3~16 meters	2.2~28 meters
PTC330	1.4~44 meters	2.5~76 meters

- **Installed 2~3 meters high from the floor.**
- **No human-outline figure on posters/screens/monitors/TVs in the background.**
- **Less than three people in a single camera view.**

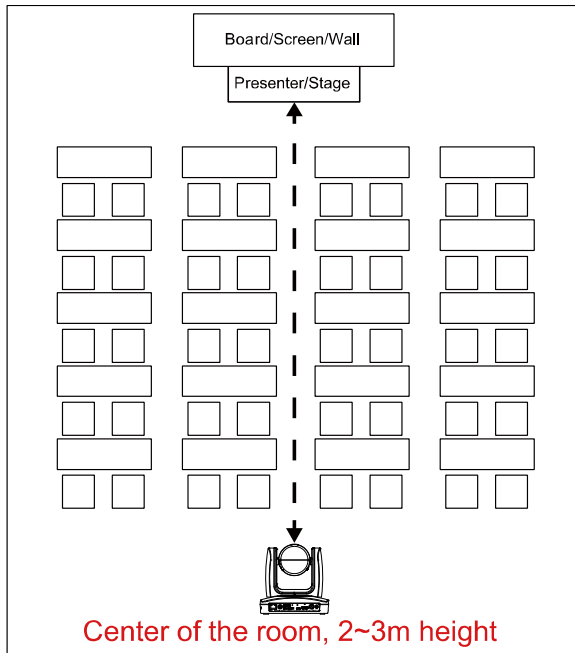

# Remote Control

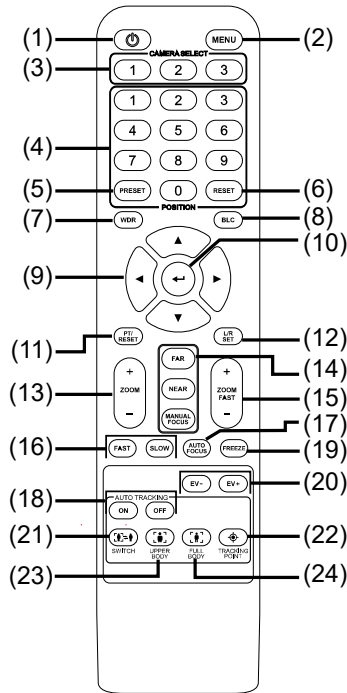

Name	Function
(1) Power	Turn the unit on/standby.
(2) Menu	Open and exit the OSD menu.
(3) Camera Select	CAM1 to CAM3 button Selects a camera to operate.
(4) Numeric Pad	<ul style="list-style-type: none"> <li>■ Use for setting the preset position 0~9.</li> <li>■ Press number button (0~9) to move the camera to pre-configure preset position 0~9.</li> </ul>
(5) Preset	Press and hold <b>"Preset"</b> + <b>"Number button (0~9)"</b> to set the preset position.
(6) Reset	Press and hold <b>"Reset"</b> + <b>"Number button (0~9)"</b> to cancel pre-configure preset position.
(7) WDR	Turn on/off WDR function.
(8) BLC	Turn on/off backlight compensation.
(9) ▲, ▼, ◀, & ▶	Pan and tilt the camera.
(10) Enter	When open the OSD menu and Confirm the selection or make a selection in OSD menu.
(11) PT Reset	Reset the Pan-Tilt position. (Re-calibration)

Name	Function
(12) L/R DIR	Left and right orientation setting. <ul style="list-style-type: none"> <li>- Press and hold “L/R DIR” button + number button “1” to set the direction of the camera panning movement opposite to that indicated by the arrow of the ◀/▶ buttons.</li> <li>- Press and hold“L/R DIR” button + number button “2” to set the direction of the camera panning movement same as the arrow of the ◀/▶ buttons.</li> </ul>
(13) Zoom +/-	Zoom in/out slow.
(14) MF/Far/Near	Enable manual focus. Use Far/Near to adjust the focus.
(15) Zoom Fast +/-	Zoom in/out fast.
(16) Pan-tilt Fast/Slow	Pan-Tilt speed adjustment.(24-speed)
(17) AF	Auto focus.
(18) Auto Tracking	Auto Tracking on/off.
(19) Freeze	Freeze the live image
(20) EV +/-	EV level adjustment.
(21) Switch	Change presenter (Tracking target)
(22) Tracking Point	When presenter enters this area, the camera will start tracking. Short press the button will recall preset1, Long press(over 0.5sec) the button will switch tracking mode (v0.0.0000.21 or later FW).
(23) Upper Body	Presenter’s size on screen is upper body.
(24) Full Body	Presenter’s size on screen is Full body.



# Setup the Camera

## OSD Menu

Press **MENU** button on the remote controller to call out the OSD menu and use ▲, ▼, ◀, ▶ and ↩ button to operate the OSD menu.

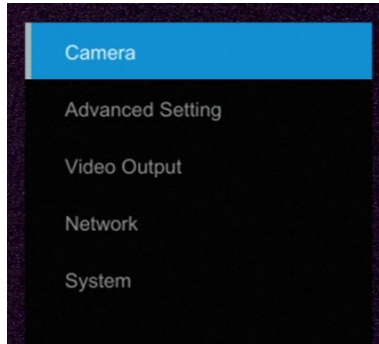

## Setup IP Address of the Camera

### Static IP

1. Press **MENU** button on the remote controller to call out OSD menu.
2. Go to **Network > Static IP**.

**[Note]** Turn the DHCP off before setup static IP (Network > DHCP > Off).

3. Select the **IP address, Gateway, Mask, and DNS** to configure. Press **↩** and use ◀, ▶, number pad to enter the data.

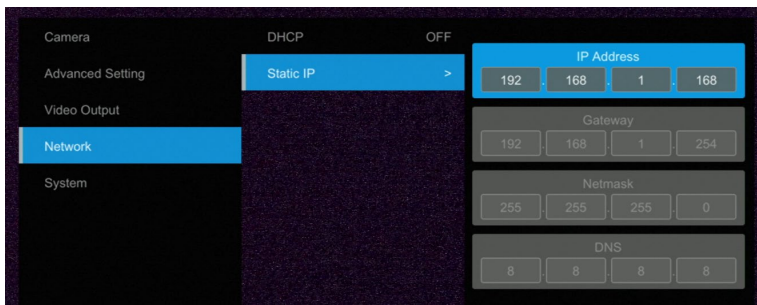

## DHCP

1. Press **MENU** button on the remote controller to call out OSD menu.
2. Go to **Network > DHCP > On**.



3. After turn the DHCP on, the user can go to **System > Information** to view IP address.

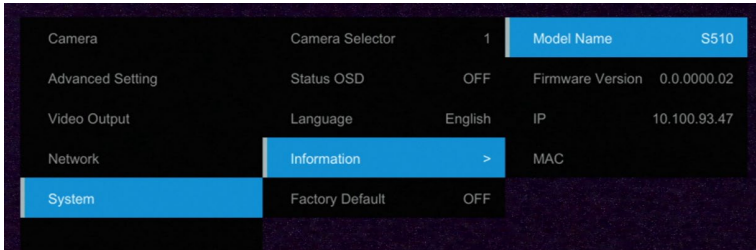

## OSD Tree

### Camera

Setup camera parameters – Exposure mode, White balance, Pan-Tilt Zoom, Noise reduction, Frequency, Saturation, Contrast, Sharpness, Mirror, and Flip.

Camera	Exposure Mode	
	Full Auto	Exposure Value/Gain Limit Level/Slow Shutter
	Shutter Priority	Exposure Value/Shutter Speed/Gain Limit Level
	Iris Priority	Exposure Value/Iris Level/Gain Limit Level/Slow Shutter
	Manual	Iris Level/Shutter Speed/Gain Level
	Bright	0 - 31
	White Balance	Auto/AWT/Indoor/Outdoor/One Push/Manual <b>[Note]</b> AWB auto range is about 3500K color temperature, when the color temperature is less than 3500K, please use AWT.
	R Gain	0~255
	B Gain	0~255
	Pan Tilt Zoom	Pan/Tilt Slow /Preset Speed/Digital Zoom/Digital Zoom Limit
	Noise Filter	OFF/Low/Medium/High
	Saturation	0~10
	Contrast	0~4
	Sharpness	0~3
	Mirror	OFF/ON
	Flip	OFF/ON

## Advanced Setting

Advanced Setting	Audio	
	Input Type	Mic in/Line in
	Auto Gain Control	OFF/ON
	Noise Suppression	OFF/Low/Normal
	Audio Volume	0 ~ 10
	Control	
	Type	RS232/RS422
	Protocol	VISCA/Pelco-P/ Pelco-D
	Camera Address	1~7
	Baud Rate	2400/4800/9600/38400
	Tracking	ON/OFF

## Video Output

Select video resolution.(2160p is supported on PTC310U and PTC330U only)

Priority Mode	2160P/1080P			
Frequency	50Hz/59.94Hz/60Hz			
Video Format	2160p/30	2160p/29.97	2160p/25	1080p/60
	1080p/59.94	1080p/30	1080i/60	1080i/59.94
	720p/60	720p/59.94	1080p/50	1080p/25
	1080i/50	720i/50		

## Network

Setup IP mode – DHCP or static IP.

Network	DHCP	Off/On
	Static IP	IP Address
		Gateway
		Netmask
		DNS

## System

- **Status OSD:** Enable/disable Preset status (Save Preset, Call Preset, Cancel Preset) display on the screen.
- **Camera Selector:** Set the camera ID 1~3 for using remote controller on multiple cameras control (also see [\(2\) Camera select](#) in Remote Control chapter).
- **NDI:** Enable/disable NDI function. For detail setting refer to [Setup NDI Function](#) chapter.
- **Tally:** Enable tally function.

System	Camera Selector	1~3
	Status OSD	OFF/ON
	Language	English/繁中
	NDI	OFF/ON
	Tally	Disable/Enable
	Information	Model Name/Firmware Version/IP /MAC
	Factory Default	OFF/ON

## Web Setup

Connect the camera from a remote site through the internet.

### Using the AVer IPCam Utility to Find the Camera

To find the IP address of your cameras, you can execute the IPCam Utility installer. Follow the below steps to find the IP address of the camera.

1. Download the IPCam Utility from <http://www.aver.com/download-center> .
2. Run the IPCam Utility
3. Click Search, and all available devices will be listed on the screen
4. Select a camera from the list.
5. The corresponding fields of IP address will display.
6. Double-click on the IP address of the camera from the list can connect to the camera through the browser.

**[Note]** If IPCam utility cannot find the camera, please check following:

1. Please make sure the Ethernet connection of camera is well connected.
2. The camera and PC (IPCam utility) are in the same LAN segment.

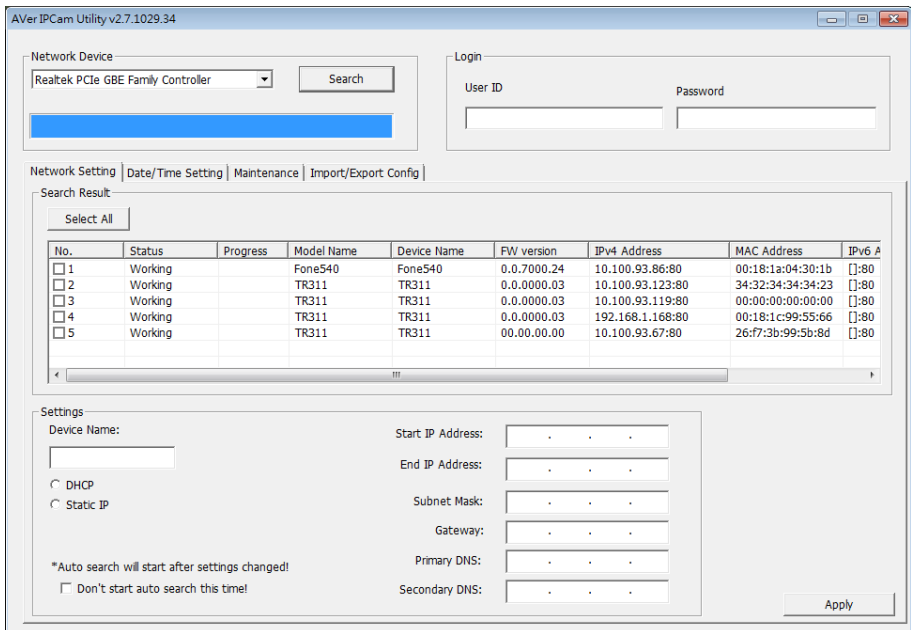

## Using AVer PTZ Management Software to Find the Camera

To find the IP address of your cameras, you can download and install the AVer PTZ Management Software. Follow the below steps to find the IP address of the camera.

1. Download the AVer PTZ Management Software from <https://www.aver.com/download-center>
2. Select the “Software” tab and download the Windows program and install it.
3. After setting up the user ID and password, login to the software (default Username/Password: admin/admin) then

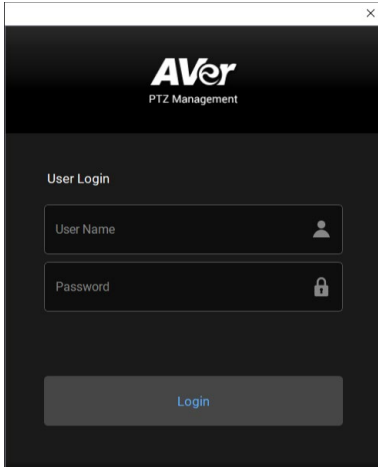

The screenshot shows the AVer PTZ Management software login interface. At the top, the AVer logo and 'PTZ Management' text are displayed. Below this, there is a 'User Login' section with two input fields: 'User Name' (with a person icon) and 'Password' (with a lock icon). A 'Login' button is located at the bottom of the form.

4. Select “Setup”, “Add” and then “Auto Search”.

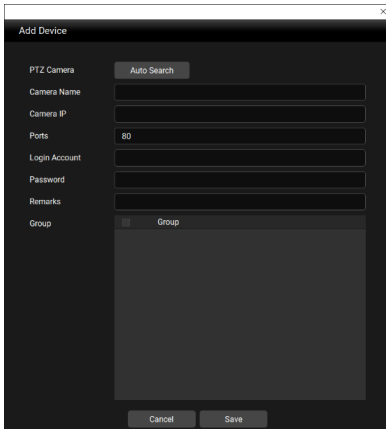

The screenshot shows the 'Add Device' window. It features a 'PTZ Camera' section with an 'Auto Search' button. Below this, there are several input fields for 'Camera Name', 'Camera IP', 'Ports' (with '80' entered), 'Login Account', 'Password', 'Remarks', and 'Group'. At the bottom, there are 'Cancel' and 'Save' buttons.

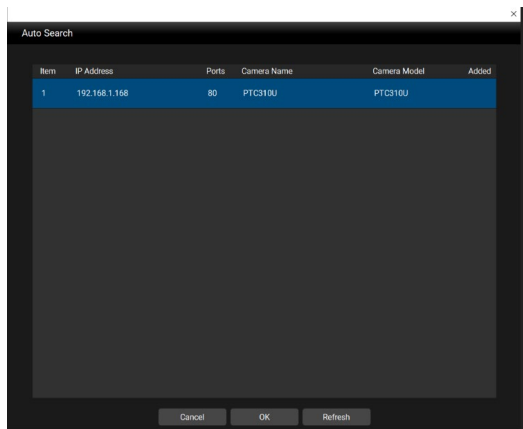

The screenshot shows the 'Auto Search' window displaying a table of discovered cameras. The table has the following columns: Item, IP Address, Ports, Camera Name, Camera Model, and Added. One camera is listed in the table.

Item	IP Address	Ports	Camera Name	Camera Model	Added
1	192.168.1.168	80	PTC310U	PTC310U	

At the bottom of the window, there are 'Cancel', 'OK', and 'Refresh' buttons.

## Make a Connection to the Camera via Browser

1. Find the IP address of the camera. Call out OSD menu and select **"System" > "Information"** Or use AVer IPCam utility to find the IP address of the camera.

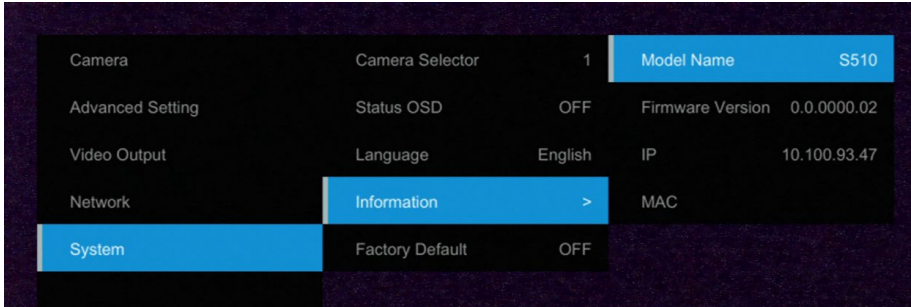

2. Open the browser and enter the IP address of the camera. The PC/laptop is required an internet access.  
After connecting to the camera, enter the user account and password (default is **admin/admin**) to login Web.











## Live View

In live view, the user can setup Camera Control (zoom in/out, focus, camera direction control), Preset setting, and Tracking Control(on, off, tracking mode).



## Pan-Tilt-Zoom Control

To operate the PTZ Camera motion.

Use , , , and  to adjust the camera view position and use  and  to zoom. Select  to back to default position.

**Digital Zoom:** Enable/disable digital zoom function. Move the scroll to adjust the limit of digital zoom.

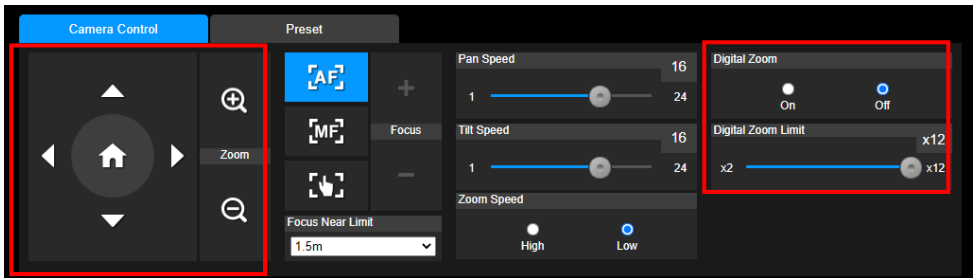

## Focus

Switch to auto (AF) or manual (MF) focus. The manual focus use + and – to adjust focus. Press “+” to adjust focus to the far end and focusing on a far subject; press “-” to adjust focus to near end and focusing on a near subject.

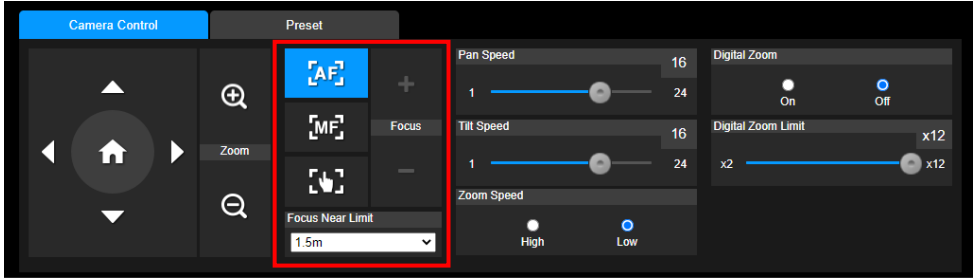

**One push focus** (  ): By clicking the button to adjust Lens focus automatically once.

**Focus Near Limit:** Set the focus distance limit.

## Manual Pan-Tilt-Zoom and Preset Speed Adjustment

Adjust the speed of manual Pan-Tilt-Zoom and Preset operation. Enable/Disable the slow mode for manual pan-tilt operation. There are totally 24 levels for manual pan-tilt speed adjustment and 2 levels (Low/High) for zoom speed adjustment. There are 5 levels for preset speed adjustment.



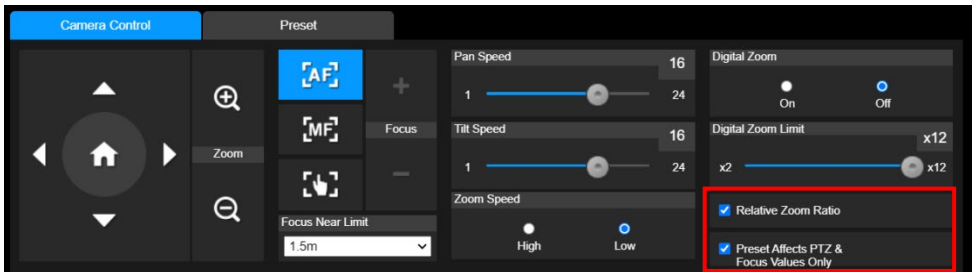

- **Pan/Tilt Slow:** When this option is set to ON, the maximum speed of manual pan-tilt operation is 40°/sec; when this option is set to Off, the maximum speed of manual pan-tilt operation is 100°/sec.
- **Relative Zoom Ratio:** When the camera zoomed in to a high ratio, pan and tilt movement will automatically slow down.
- **Preset Affects PTZ & Focus Values Only:** When enable this button, the preset point affects PTZ & Focus values only.

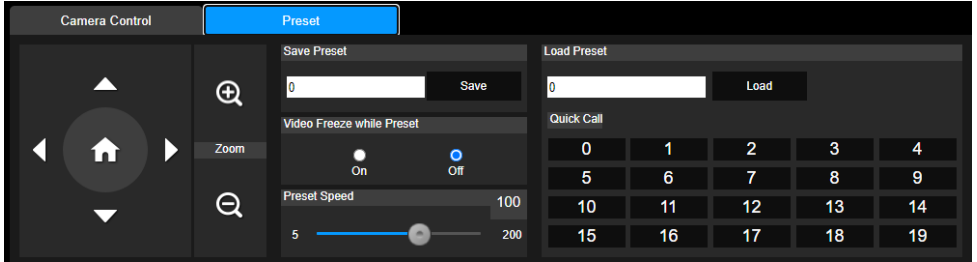

## Preset Setting

Setup preset position and view preset position.



1. Select the “Preset” tab in live view interface.
2. Use , , , and  to adjust camera view position.
3. Enter preset position number (0~255) in **Save Preset** column and select “**Save**” to save the position.
4. To call the preset position, enter a preset number (0~255) in **Load Preset** column or select the preset number (0~19) from **Quick Call** section.(Recalling preset will disable auto tracking)
5. **Video Freeze with Preset:** On/Off the screen view freeze function. When “**Video Freeze with Preset**” is on, during the preset operation, the screen will freeze until the operation is done.

## Tracking Control

Enable/disable tracking function, select tracking mode, and operate one-click tracking function.

- Tracking mode(Tracking mode setup refer to [Tracking Settings](#) section)
  - **Presenter:** Camera will start tracking when object enter the tracking point (preset point) and the face of object is detected.
  - **Zone:** Camera will start tracking when object is moving between the preset tracking block area.
  - **Hybrid:** Mix the Presenter mode and Zone mode together.

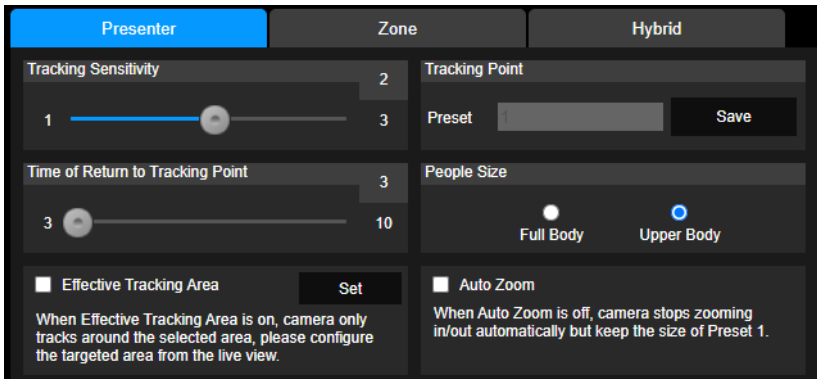

## Click Tracking Function

This function allows user to change tracking object while auto tracking.

1. Select **Click Track** button. A red frame is targeted on the tracking object and a blue frame is targeted on another object on the live screen.

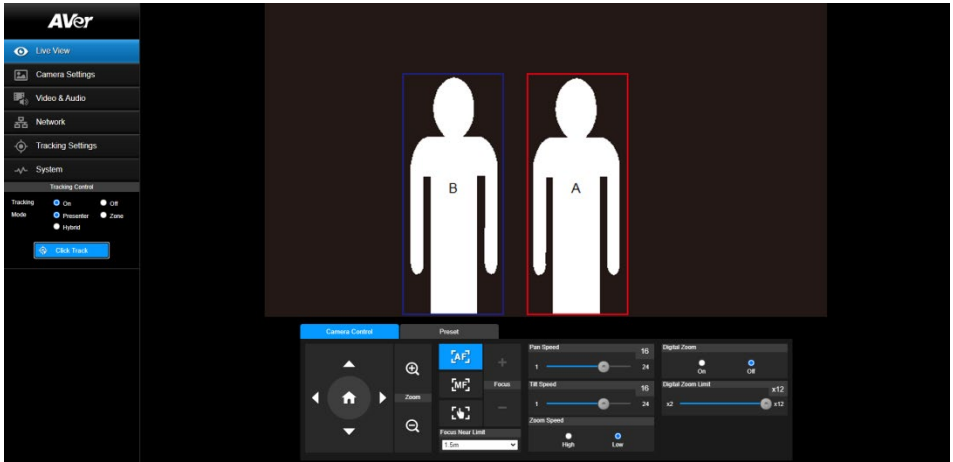

2. Click the object and when frame change to red means the tracking object is changed to the selected one.

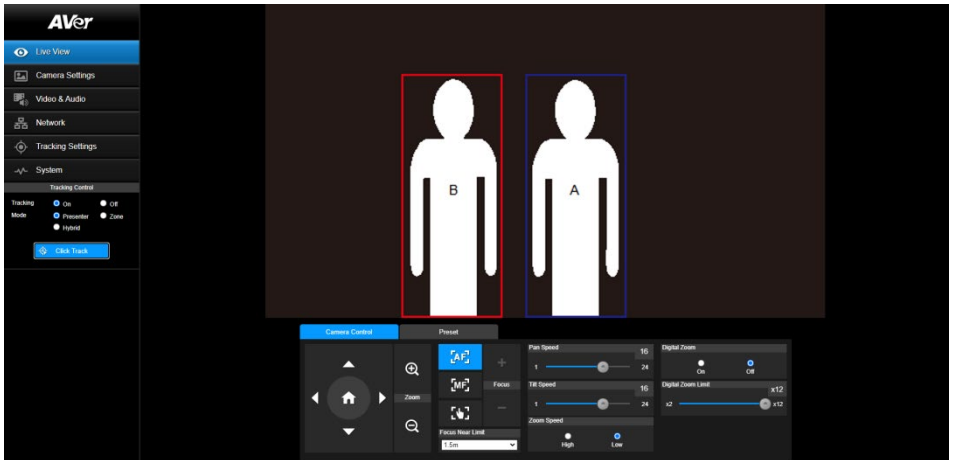

# Camera Settings

## Exposure

Setup the exposure type -- Full auto, Iris priority, Shutter priority, or manual.

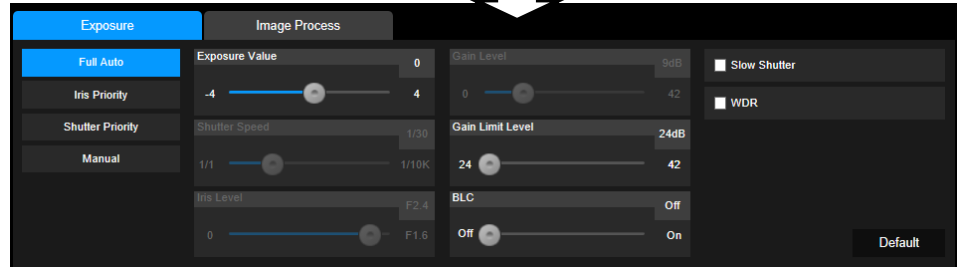
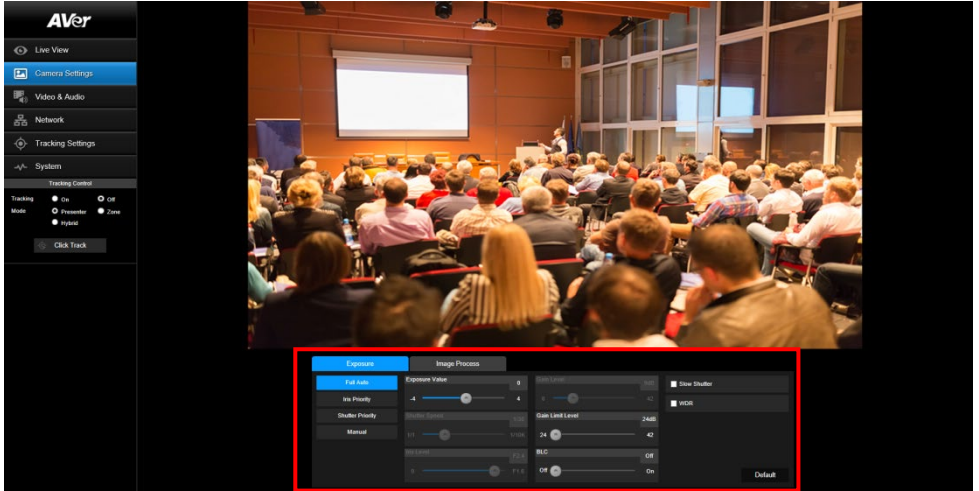

## Image Process

Setup the white balance, saturation, contrast, sharpness, noise filter, power frequency, flip, and mirror. Select the "Image Process" tab in camera setting interface.

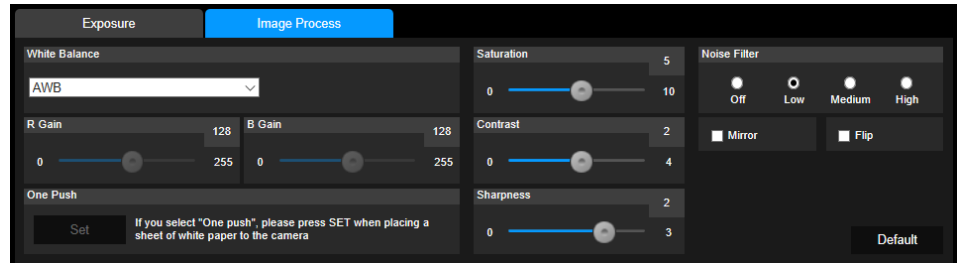

## Video & Audio

The user can setup Video Mode, Video output, Framerate, Bitrate, I-VOP internal, Encode type, Rate control, Audio input type, Audio volume, and Sampling Rate.

Video mode in the stream only, the frame rate is up to 60fps and in USB+ Streaming mode is up to 30fps.

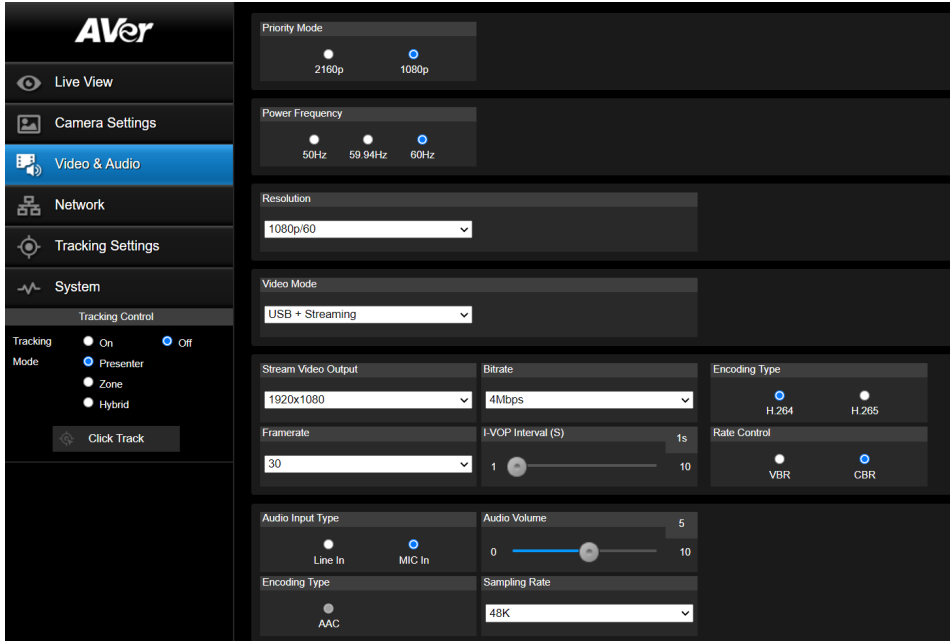

### Get 4K (2160p) output

1. Make sure that your HDMI monitor and cable support 4K (HDMI2.0 or above), select 2160p at Priority Mode via either web or OSD menu. Select 2160p/30 resolution at OSD menu to get 4K HDMI output. (3G-SDI does not support 4K)
2. Select "USB Only" at Video Mode to get 4k USB output(live stream will be off)
3. Select "Stream Only" at Video Mode to get 4k live stream output (USB will be disabled)

## Setup NDI Function

**NDI service only support on NDI models: PTC310N, PTC310UN, PTC310HN, PTC330N.**

1. Enable NDI mode by selecting “NDI” as video mode in Video & Audio page. To disable the NDI function, select other mode. The camera will reboot after selecting NDI mode.

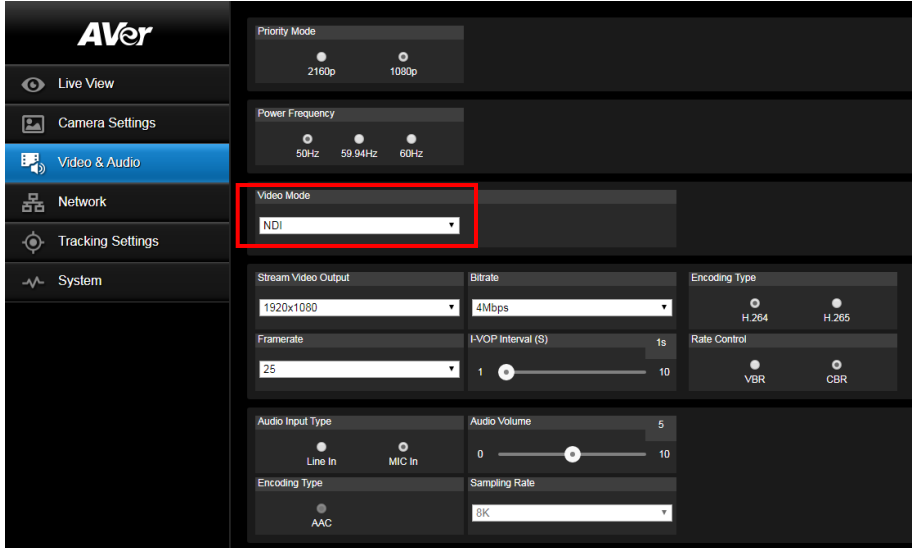

2. User can setup the following functions:
  - **Stream Video Output:** Select video output resolution.
  - **Framerate:** Select framerate of the camera.
  - **Encoding Type:** Select encoding type – **H.264** or **H.265**.
  - **Sampling Rate:** Select sampling rate value.
  - **Audio Input Type:** select audio input type – **Line In** or **MIC In**.
  - **Bitrate:** Select bitrate value – **521kbps, 1Mbps, 2Mbps, 4Mbps, 8Mbps, 16Mbps, 32Mbps**.
  - **I-VOP interval(S):** Move scroll bra to set the value – **1s** to **10s**.
  - **Audio Volume:** Move scroll bra to set the volume value – **0** to **10**.
  - **Rate control:** select the rate control type – **VBR** or **CBR**.

3. Set the identity name for display on NDI interface. Select **System > Camera ID(NDI)**. Enter the name as user wanted. The maximum character is 10. After entering the name, select the **Set** button to save and manually restart the PTZ camera for the settings to take effect.

The following characters can be displayed for camera ID:

<b>Numeric characters</b>	0123456789
<b>Alphabetical characters (upper and lower cases)</b>	ABCDEFGHIJKLMNOPQRSTUVWXYZ abcdefghijklmnopqrstuvwxyz
<b>Symbols</b>	!@#\$%^&*(),.Λ;:''+=<>?[]{} _`~\ /

Camera ID(NDI)



## Network

Setup IP address of camera – DHCP or static IP, netmask, gateway, and DNS. After setting, select “**Confirm**” to apply settings.

**Hostname:** To change the display of Hostname, allow to name the camera in other device ex IP Router. The default Hostname of camera is AVer.

The screenshot shows the AVer camera's web interface with the 'Network' menu selected. The interface is divided into several sections:

- Navigation:** Live View, Camera Settings, Video & Audio, Network (selected), Tracking Settings, System, and Tracking Control.
- Tracking Control:** Tracking is set to 'On'. Mode is set to 'Presenter'.
- DHCP:** A radio button is selected for 'On'. Below it, fields for IP (10.100.91.49), Netmask (255.255.255.0), Gateway (10.100.91.254), and DNS (8.8.8.8) are visible.
- Hostname:** A text field contains 'AVer'. A 'Confirm' button is located to the right.
- RTMP Settings:** Fields for 'Server URL' and 'Stream Key' are present. 'Start Stream' and 'STOP' buttons are at the bottom.
- RTSP Security:** A radio button is selected for 'On'.
- SRT Settings:** Fields for 'Destination IP' (192.168.1.112), 'Port' (8889), 'Encryption' (None), 'Latency' (1000 ms), and 'Passphrase' are visible. 'Start Stream' and 'STOP' buttons are at the bottom. The 'Connect Status' is 'Disconnected'.

## RTMP Setting

Setup for uploading the camera's live view to the broadcasting platform (ex: Youtube).

This close-up screenshot focuses on the 'RTMP Settings' section of the interface. It shows two empty text input fields labeled 'Server URL' and 'Stream Key'. Below these fields are two buttons: 'Start Stream' and 'STOP'.

Get the RTMP server URL and stream key from the broadcasting platform and enter in “**Server URL**” and “**Stream key**” column.

Select “**Start stream**” to begin uploading the live video of the camera to the broadcasting platform.

Select “**Stop**” to stop uploading the video.

**[Note]** To get the RTMP server URL and stream key, please refer to the instruction of broadcasting.

## Using RTSP Connect to Camera

To use RTSP player connecting to the camera; please enter the following RTSP URL in your application such as VLC, PotPlayer or Quick Time.

“rtsp://IP address of camera/live\_st1”

For Example: rtsp://192.168.1.168/live\_st1

(the camera default IP address: 192.168.1.168)

Enable/disable RTSP security function if needed.

(When RTSP Security is On, the RTSP stream ID/Password will be synced to the web login User name/ Password.)

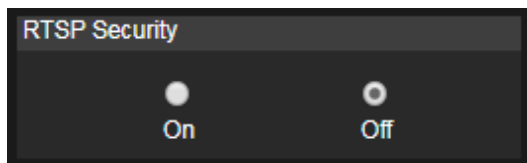

# SRT Stream

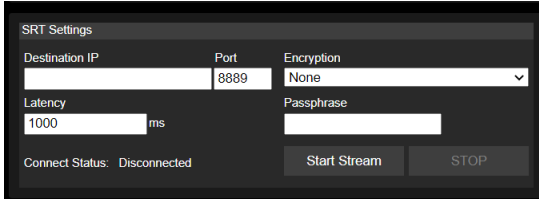

## Example 1 vMix:

Set the workstation and the PTC300 camera in the same network. Check the workstation's IP address (Destination IP). Example:

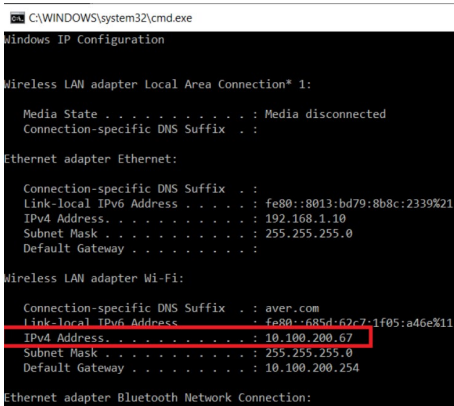

Select SRT(Listener) from Stream Type in vMix Input Select window.

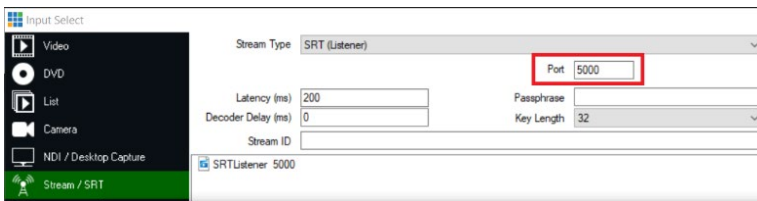

Enter the information into the SRT Settings PTC310 web interface, then click on “Start Stream”, Connect Status shows “Connected”.

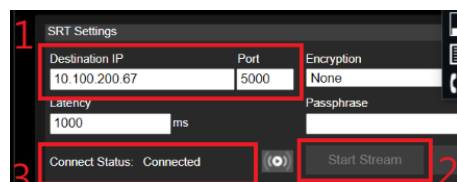

## Example2 OBS (Open Broadcaster Software)

Set the workstation and the PTC300 camera in the same network. Check the workstation's IP address (Destination IP). Example:

```
Connection-specific DNS Suffix . : aver.com
Link-local IPv6 Address . . . . . : fe80::f1dc:bcd8:87bd:ac1e%12
IPv4 Address. . . . . : 10.100.105.127
Subnet Mask . . . . . : 255.255.255.0
Default Gateway . . . . . : 10.100.105.254
```

Open OBS, add a scene, add a source, enter `srt://Work Station IP:port?mode=listener`

Example: `srt://10.100.105.127:8889?mode=listener`

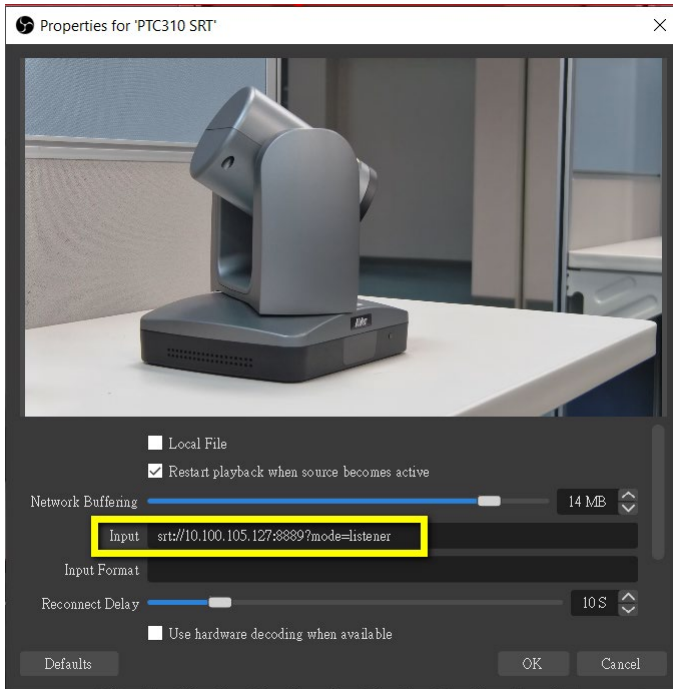







**[Note]** If there is no image, please try right click on the source->Transform->Fit to screen to re-scale image.

# Tracking Setting

Set up Tracking mode – Presenter, Zone, and Hybrid mode.

## Presenter Mode

Camera will start tracking when object enters the tracking point (preset point).

1. Use , , , ,  and  to adjust the camera to tracking point (preset position).
2. Then, select **Save to Preset 1** to save the tracking point.

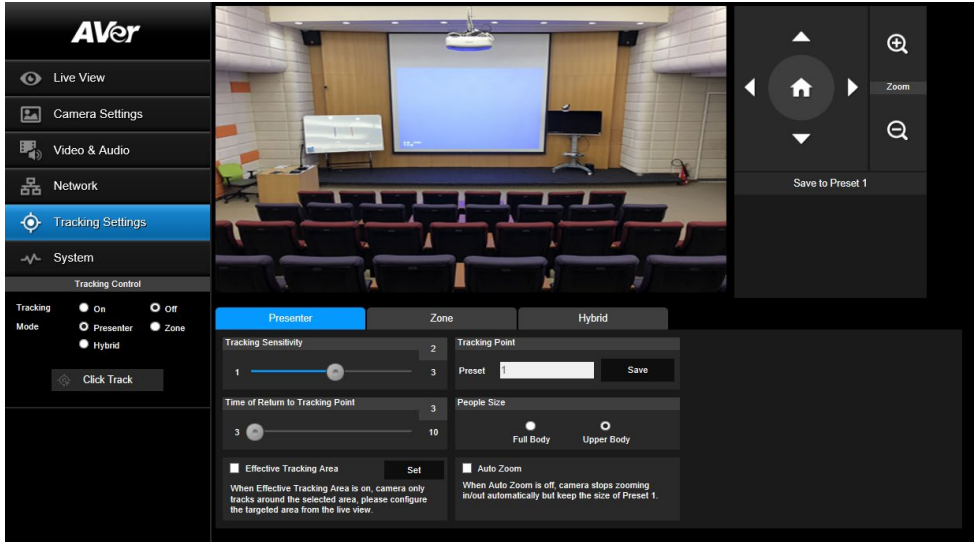

3. **Tracking Sensitivity:** Set the sensitive level of tracking. Move bar to set the value. The current value is displayed at upper right corner.

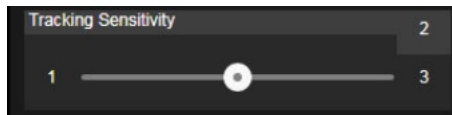

4. **Time of Return to Tracking Point:** Set the idle time for camera returning to tracking point. Move bar to set the value (in seconds). The current value is displayed at upper right corner.

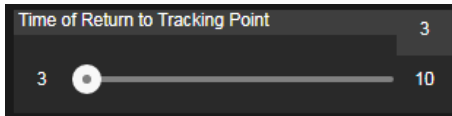

5. **People Size:** Select the people in full or half size while tracking.

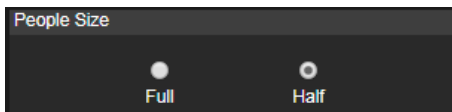

6. **Effect Tracking Area:** When Effective Tracking Area function is on, camera only tracks around the selected area. Check the box to turn on the Effective Tracking Area function then click Set to configure the targeted area in the live view. Move the upper left corner and the lower right corner of the red solid frame to define the targeted area.

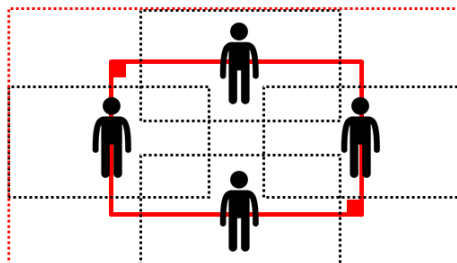
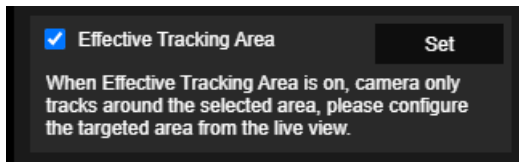

**[Note]** The position of the red solid frame corresponds to the central position of the presenter. The black dotted frames represent the tracking areas for different positions of the presenter. Therefore, the red dotted frame is the actual effective tracking area of the red solid frame.

7. **Auto Zoom:** When Auto Zoom is off, camera stops zooming in/out automatically but keep the size of Preset 1.

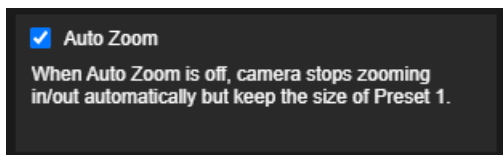





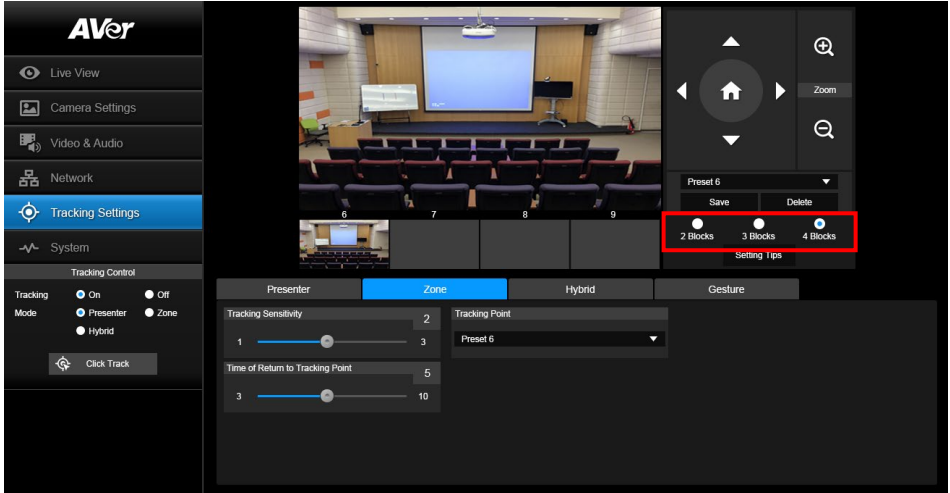

## Zone Mode

Setup the block area for the camera to detect object and follow-up the object to move the camera when the object is in block area that user has set.

1. Select the **Blocks** (2, 3, or 4). Each block is corresponding to one preset position. The maximum is 4 blocks (4 preset positions).



2. Select the block and Set the preset positions in order (preset 6 to preset 9). Use , , , ,  and  to move the camera to wanted position and select **“Save”** to save the preset position. And, a snapshot of the preset image will show at corresponding image display box. Repeat the step to set another preset position.

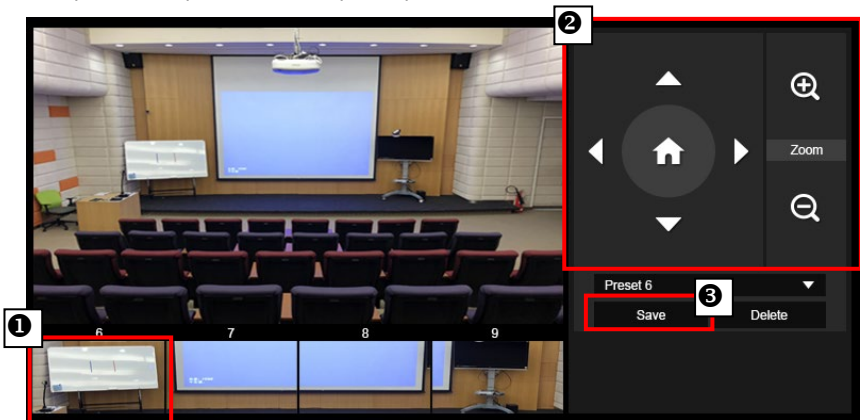

**[Note]** Set each preset overlapping the next preset view (one man width overlap), no or less zoom between presets. Examples below:



**[Note]** Set the preset view to clearly see at least 60% upper body of the presenter to ensure tracking accuracy. Make sure there is no any other human-outline poster/TV/monitor in the background.

Preset for Zone Mode, Example:



3. **Tracking Sensitivity:** Set the sensitive level of tracking. Move bar to set the value. The current value is displayed at upper right corner.

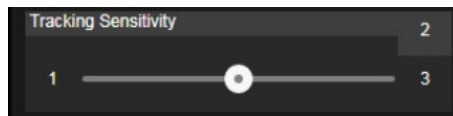

4. **Time of Return to Tracking Point:** Set the idle time for camera returning to tracking point. Move bar to set the value (in seconds). The current value is displayed at upper right corner.

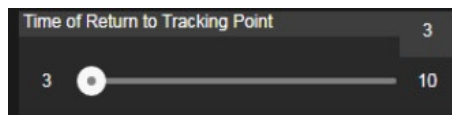



## Hybrid Mode

This function allows the user to use two types of tracking modes: “Presenter mode” and “Zone mode” at the same time. When the presenter enters selected preset points, it will change to Zone position; when the presenter leaves the preset points, camera will follow presenter to do Auto Tracking function.

1. Mix two tracking modes “Presenter” and “Zone” at the same time. For Hybrid mode, do not set Zone preset points overlapping or close to each other. It is recommended to leave some distance between Zone preset points.



2. Use direction control panel to move the camera to desired position and select “save” to save the preset position. And, a snapshot of the preset image will show at corresponding image display box. Select preset position and select “Delete” to delete the saved preset position.(Preset 10,11,12,13)

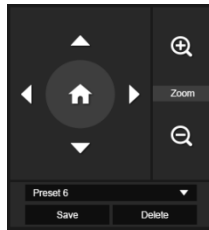

3. Set the sensitive level of tracking. Move bar to set the value. The current value is displayed at upper right corner.

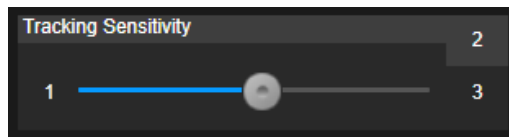

4. Set the idle time for camera returning to tracking point. Move bar to set the value (in seconds). The current value is displayed at upper right corner.

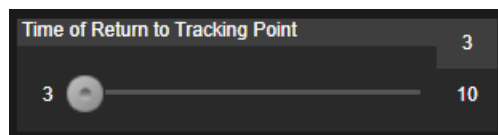

5. When losing tracking target and going back to Tracking Point.



6. Presenter size, Full body will show the whole Body on screen and Upper will only show half body.

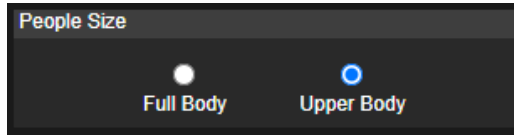

# Quick Setup for Tracking

## Presenter Mode

1. Use IR remote to adjust the camera view properly then save to preset1 as the initial position
2. Press tracking "On" button on IR remote, here you go!
3. Press "UPPER BODY" key to get closer view (up to 60% body), or FULL BODY to see entire presenter in the view.
4. Press "Switch" key to switch between presenters. Initially the camera tracks the one who is in the center of view. Every switch follows the sequence: left to right, then back to far left one in the camera view(see picture below). To see which presenter is being tracked, press numeric key"7" for seven times to call/cancel engineering mode while tracking, you will see purple boxes shown on all human-outline objects, and who under yellow box is being tracked.

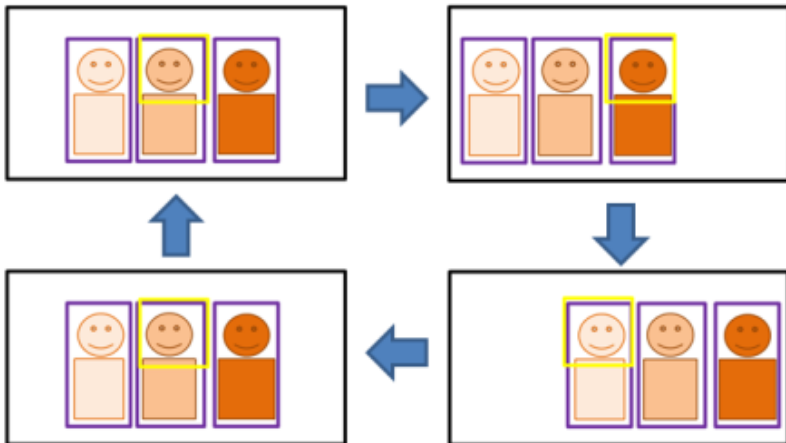

## Zone Mode

2 blocks initially selected and preset 6 is initially the start position. But if you prefer 3 or 4 blocks for Zone mode tracking and prefer another preset as start position, go to web setting.

1. Use IR remote to adjust the camera view properly then save to preset6, preset7
2. Long press "Tracking Point" to switch tracking mode from Presenter Mode to Zone Mode (the hotkey supported at firmware v0.0.0000.21 or later)
3. Press "ON", here you go!

## System

- **System information:** It displays **Model Name, IP Address, Serial Number, MAC Address** and **Firmware Version**.
- **Factory Default:** Reset the camera back to factory default value.
- **Login in:** The default login in name and password are **admin/admin**. User can change if needed.
- **Status OSD:** Enable/disable Preset status (Save Preset, Call Preset, Cancel Preset) display on the screen.
- **Language:** Change the Web UI language.
- **Camera ID (NDI):** Set the camera ID as identification for NDI function. To setup NDI function, please refer to [NDI Function](#) section.
- **Power Up to Preset/ Power off to preset:** If enabling Power Up/Off to Preset function, the camera will move to the saved preset point in the field when the camera powers up/off.
- **Reboot:** To restart the camera from web page.
- **Customized Function:** Ability to execute some specific functions by using VISCA command.

The screenshot displays the AVer camera web interface. On the left is a navigation sidebar with the following menu items: Live View, Camera Settings, Video & Audio, Network, Tracking Settings, and System (highlighted in blue). Below the System menu is a 'Tracking Control' section with radio buttons for 'Tracking' (On/Off) and 'Mode' (Presenter, Zone, Hybrid), and a 'Click Track' button. The main content area is titled 'System' and contains several sections: 'Upgrade firmware' with a 'Upgrade' button; 'Factory Default' with a 'Reset To Factory Default' button; 'Model Name' and 'Serial Number' fields; 'Login' section with 'Login Name' (1) and 'Login Password' fields, and 'Change'/'Cancel' buttons; 'Language' dropdown menu set to 'English' and a 'Reboot' button; 'Status OSD' section with 'On'/'Off' radio buttons; 'Setting' section with 'Import Setting' and 'Export Setting' buttons; 'Power Up to Preset' and 'Power Off to Preset' sections, each with a 'Save' button and a value of '0'; and a 'Customized Function' section at the bottom.

## Upgrade Firmware

1. Download the newest firmware from <http://www.aver.com/download-center>.
2. Connect to the camera through the browser.
3. Select **System** > **Browse** the FW file > **Upgrade** firmware
4. Select the firmware and select the “**Upgrade**” button.
5. After updating, refresh the browser.

The screenshot displays the AVer camera's web management interface. On the left is a navigation sidebar with the AVer logo and menu items: Live View, Camera Settings, Video & Audio, Network, Tracking Settings, and System (highlighted in blue). Below System are Tracking Control options: Tracking (On/Off), Mode (Presenter, Zone, Hybrid), and a Click Track button. The main content area shows the 'Upgrade firmware' dialog box, which is highlighted with a red rectangle. This dialog contains three buttons: '選擇檔案' (Select File), '未選擇任何檔案' (No file selected), and 'Upgrade'. Below the dialog are sections for 'Factory Default' (Reset To Factory Default), 'Login' (Login Name: 1, Login Password: \*), 'Language' (English), 'Status OSD' (On/Off), 'Setting' (Import Setting, Export Setting), and 'Power Up to Preset' / 'Power Off to Preset' (both with a value of 0 and a Save button). A 'Reboot' button is also visible on the right side of the interface.

# VISCA RS232 Command Table

Command Set	Command	Command Packet	Comments
CAM_Power	On	8x 01 04 00 02 FF	Power ON/OFF
	Off	8x 01 04 00 03 FF	
CAM_Zoom	Stop	8x 01 04 07 00 FF	p=0 (Low) to 7 (High)
	Tele(Variable)	8x 01 04 07 2p FF	
	Wide(Variable)	8x 01 04 07 3p FF	
CAM_Focus	Stop	8x 01 04 08 00 FF	
	Auto Focus	8x 01 04 38 02 FF	
	Manual Focus	8x 01 04 38 03 FF	
	One Push	8x 01 04 18 01 FF	
	Direct	8x 01 04 47 0a 0q 0r 0s FF	pprs: Zoom Position Normal Auto
CAM_WB	Auto	8x 01 04 35 00 FF	
	ATW	8x 01 04 35 04 FF	
	Indoor	8x 01 04 35 01 FF	
	Outdoor	8x 01 04 35 02 FF	
	One Push WB	8x 01 04 35 03 FF	One Push WB mode
	Manual	8x 01 04 35 05 FF	Manual Control mode
CAM_RGain	One Push	8x 01 04 10 05 FF	One Push WB Trigger
	Up	8x 01 04 03 02 FF	Manual Control of R Gain
CAM_DGain	Down	8x 01 04 03 03 FF	
	Up	8x 01 04 04 02 FF	Manual Control of B Gain
CAM_Bgain	Down	8x 01 04 04 03 FF	
	Full Auto	8x 01 04 39 00 FF	Automatic Exposure mode
CAM_AE	Manual	8x 01 04 39 03 FF	Manual Control mode
	Shutter Priority	8x 01 04 39 0A FF	Shutter Priority Automatic Exposure mode
	Iris Priority	8x 01 04 39 0B FF	Iris Priority Automatic Exposure mode
	Bright	8x 01 04 39 0D FF	Bright Mode (Manual control)
CAM_Shutter	Up	8x 01 04 0A 02 FF	Shutter Setting
	Down	8x 01 04 0A 03 FF	
CAM_Iris	Up	8x 01 04 0B 02 FF	Iris Setting
	Down	8x 01 04 0B 03 FF	
CAM_Gain	Up	8x 01 04 0C 02 FF	Gain Setting
	Down	8x 01 04 0C 03 FF	
CAM_Bright	Up	8x 01 04 0D 02 FF	Bright Setting
	Down	8x 01 04 0D 03 FF	
	Up	8x 01 04 0E 02 FF	Exposure Compensation Amount Setting
	Down	8x 01 04 0E 03 FF	
CAM_Backlight	On	8x 01 04 33 02 FF	Back Light Compensation ON/OFF
	Off	8x 01 04 33 03 FF	
CAM_Preset	Reset	8x 01 04 3F 00 pp FF	
	Set	8x 01 04 3F 01 pp FF	pp: Preset Number 0x00-0xFF
	Recall	8x 01 04 3F 02 pp FF	
CAM_Menu	On/Off	8x 01 06 06 10 FF	Display ON/OFF
	Up	8x 01 06 01 VV WW 03 01 FF	VV: Pan speed setting 0x01 (low speed) to 0x18 (high speed) WW: Tilt speed setting 0x01 (low speed) to 0x18 (high speed)
Down	8x 01 06 01 VV WW 03 02 FF		
Left	8x 01 06 01 VV WW 01 03 FF		
Right	8x 01 06 01 VV WW 02 03 FF		
Up/Left	8x 01 06 01 VV WW 01 01 FF		
Up/Right	8x 01 06 01 VV WW 02 01 FF		
Down/Left	8x 01 06 01 VV WW 01 02 FF		
Down/Right	8x 01 06 01 VV WW 02 02 FF		
Stop	8x 01 06 01 VV WW 03 03 FF		
Home	8x 01 06 04 FF		
Reset	8x 01 06 05 FF		
Absolute Position (v26 or above)		8x 01 06 02 VV WW 0Y 0Y 0Y 0Z 0Z 0Z 0Z FF	VV: Pan speed setting 0x01 (low speed) to 0x18 (high speed) WW: Tilt speed setting 0x01 (low speed) to 0x18 (high speed) YYYY: Pan Position 8A14 to 763C (CENTER 0000) ZZZZ: Tilt Position 468B to E898 (Image Flip: OFF) (CENTER 0000)
CAM_Wdr	On	8x 01 04 3D 02 FF	Wdr ON/OFF
	Off	8x 01 04 3D 03 FF	
CAM_MenuEnter		8x 01 7E 01 02 00 01 FF	Enter Submenu
Tally Lamp ON		8x 01 7E 01 0A 00 02 FF	
Tally Lamp OFF		8x 01 7E 01 0A 00 03 FF	
Freeze	Freeze On	81 01 04 62 02 FF	Freeze On Immediately
	Freeze Off	81 01 04 62 03 FF	Freeze Off Immediately
	Preset Freeze On	81 01 04 62 22 FF	Freeze On When Running Preset
	Preset Freeze Off	81 01 04 62 23 FF	Freeze Off When Running Preset
Auto Tracking	On	8x 01 04 7D 02 FF	Auto tracking ON/OFF
	Off	8x 01 04 7D 03 FF	
CAM_Memory Special	Set	8x 01 04 3F 01 pp FF	pp: 0x00 To 0xFF normal preset pp: 0x5F => Trun on OSD menu pp: 0xA0 => Full Body pp: 0xA1 => Upper Body pp: 0xA2 => Tracking Point pp: 0xA3 => Switch pp: 0xA4 => Presenter mode (support with v25 or newer firmware) pp: 0xA5 => Zone mode (support with v25 or newer firmware)

Inquiry Command	Command Packet	Reply Packet	Comments
CAM_PowerInq	8x09 04 00 FF	y0 50 02 FF y0 50 03 FF	On Off
CAM_WBModelInq	8x09 04 35 FF	y0 50 00 FF	Auto
		y0 50 01 FF	In Door
		y0 50 02 FF	Out Door
		y0 50 03 FF	One Push WB
		y0 50 04 FF	ATW
		y0 50 05 FF	Manual
CAM_RGainInq	8x09 04 43 FF	y0 50 00 00 0p 0q FF	pq: R Gain
CAM_BGainInq	8x09 04 44 FF	y0 50 00 00 0p 0q FF	pq: B Gain
CAM_AEModelInq	8x09 04 39 FF	y0 50 00 FF	Full Auto
		y0 50 03 FF	Manual
		y0 50 0A FF	Shutter Priority
		y0 50 0B FF	Iris Priority
		y0 50 0D FF	Bright
CAM_ShutterPosInq	8x09 04 4A FF	y0 50 00 00 0p 0q FF	pq: Shutter Position
CAM_IrisPosInq	8x09 04 4B FF	y0 50 00 00 0p 0q FF	pq: Iris Position
CAM_GainPosInq	8x09 04 4C FF	y0 50 00 00 0p 0q FF	pq: Gain Position
CAM_BrightPosInq	8x09 04 4D FF	y0 50 00 00 0p 0q FF	pq: Bright Position
CAM_ExpCompPosInq	8x09 04 4E FF	y0 50 00 00 0p 0q FF	pq: ExpComp Position
CAM_FocusModelInq	8x09 04 38 FF	y0 50 02 FF	Auto Focus
		y0 50 03 FF	Manual Focus
CAM_FocusPosInq	8x09 04 48 FF	y0 50 0p 0q 0r 0s FF	pqrs: Focus Position
zoom_Pos_Inq	8x09 04 47 FF	y0 50 0p 0q 0r 0s FF	pqrs: Zoom Position
PT_Pos_Inq	8x09 06 12 FF	y0 50 0Y 0Y 0Y 0Z 0Z 0Z FF	YYYY: Pan Position 8A14 to 762C (CENTER 0000) ZZZZ: Tilt Position 4688 to E898 (Image Flip: OFF) (CENTER 0000)

The x value = VISCA Camera ID: 1 to 7 for RS232/RS422 connection.

## Visca over IP Settings

VISCA over IP

PORT

Internet protocol	IPv4
Transport protocol	UDP
Port address	52381

FORMAT

func	byte 0	byte 1	byte 2	byte 3	byte 4	byte 5	byte 6	byte 7	byte8 ~~~~ byte23
data	Value1	Value2	Payload length 1~16 (0x0001~0x0010)		Sequence number 0X00000000 ~ 0XFFFFFFF			Payload (1 to 16 bytes) VISCA Packet (see page VISCA)	

Payload type

Name	Value1	Value2	Description
VISCA command	0x01	0x00	Stores the VISCA command.
VISCA inquiry	0x01	0x10	Stores the VISCA inquiry.
VISCA reply	0x01	0x11	Stores the reply for the VISCA command or VISCA inquiry

Sequence number

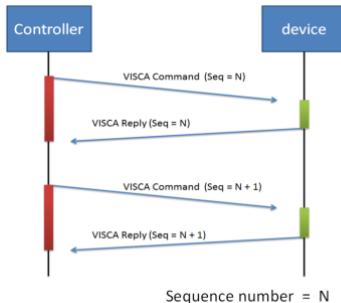

The x value should be 1 for Visca-over-IP string, e.g. 01 00 00 09 00 00 00 01 81 01 06 01 07 07 01 03

FF

## CGI command

CGI List for Video Transmission					
CGI item name	URL	Command	Parameter Name	Parameter value	Description
Get JPEG	/snapshot				1280x720 jpg
Get RTSP stream	rtsp://ip/live_st1				

CGI List for Camera Control					
CGI item name	URL	Command	Parameter Name	Parameter value	Description
up start	/cgi-bin?SetPtzf=	1,0,1&(random)			
up end	/cgi-bin?SetPtzf=	1,0,2&(random)			
down start	/cgi-bin?SetPtzf=	1,1,1&(random)			
down end	/cgi-bin?SetPtzf=	1,1,2&(random)			
left start	/cgi-bin?SetPtzf=	0,1,1&(random)			
left end	/cgi-bin?SetPtzf=	0,1,2&(random)			
right start	/cgi-bin?SetPtzf=	0,0,1&(random)			
right end	/cgi-bin?SetPtzf=	0,0,2&(random)			
zoom_in start	/cgi-bin?SetPtzf=	2,0,1&(random)			
zoom_in end	/cgi-bin?SetPtzf=	2,0,2&(random)			
zoom_out start	/cgi-bin?SetPtzf=	2,1,1&(random)			
zoom_out end	/cgi-bin?SetPtzf=	2,1,2&(random)			
set preset:	/cgi-bin?ActPreset=	1,N&(random)			N : position
load preset:	/cgi-bin?ActPreset=	0,N&(random)			N : position

CGI List for Various Settings					
CGI item name	URL	Command	Parameter Name	Parameter value	Description
exposure value	/cgi-bin?Set=	img_expo_expo,3,N&(random)	value	1 ~ 9	N : value
saturation	/cgi-bin?Set=	img_saturation,3,N&(random)	value	0 ~ 10	N : value



contrast	/cgi-bin?Set=	img_contrast,3,N&(random)	value	0 ~ 4	N : value
Tracking on:	/cgi-bin?Set=	trk_tracking,3,1&(random)			
Tracking off:	/cgi-bin?Set=	trk_tracking,3,0&(random)			
Tracking Presenter Mode:	/cgi-bin?Set=	trk_mode,3,1&(random)			
Tracking Zone Mode:	/cgi-bin?Set=	trk_mode,3,2&(random)			

# Specification

## PTC310

Camera	
Image Sensor	1/2.8" 1080p Exmor CMOS
Effective Picture Elements	2 Megapixels
Output Resolutions	Auto 1080p/60, 1080p/59.94, 1080p/50, 1080p/30, 1080p/29.97, 1080p/25, 720p/60, 720p/59.94, 720p/50, 720p/30, 720p/29.97, 720p/25
Minimum Illumination	0.4 lux (IRE50, F1.6, 30fps)
S/N Ratio	≥ 50 dB
Gain	Auto, Manual
TV Line	900 (Center)
Shutter Speed	1/1 s to 1/10,000 sec
Exposure Control	Auto, Manual, Bright mode, Priority AE (Shutter, IRIS), BLC, WDR
White Balance	Auto, ATW, Indoor, Outdoor, One push, Manual
Optical Zoom	12X
Digital Zoom	12X
Sensor Zoom	2X
Viewing Angles	DFOV : 78° (Wide) to 9° (Tele) HFOV : 70° (Wide) to 8° (Tele) VFOV : 42° (Wide) to 5° (Tele)
Focal Length	f = 3.9 mm (Wide) to 39 mm (Tele)
Aperture (Iris)	F = 1.6 (Wide) to 3.0 (Tele)
Minimum Working Distance	0.3 m (Wide), 1.5 m (Tele)
Camera	
Pan / Tilt Angles	Pan : ±170°, Tilt : +90° / -30°

Pan / Tilt Speed (Manual)	Pan : 0.1° to 100° / sec, Tilt : 0.1° to 100° / sec
Preset Speed	Pan : 200° / sec, Tilt : 200° / sec
Preset Positions	10 (IR), 255 (RS-232)
Camera Control - Interface	RS-232 (DIN8), RS-422 (RJ45), IP
Camera Control - Protocols	VISCA / PELCO-D (RS-232 / RS-422 / IP), CGI (IP)
Image Processing	Noise Reduction (2D / 3D), Flip, Mirror
Power Frequency	50 Hz, 60 Hz
<b>AI Auto Tracking Functions</b>	
Tracking Mode	Presenter Mode, Zone Mode
<b>Audio</b>	
Channel	2ch Stereo
Codec	AAC (48 / 44.1 / 32 / 24K), G.711, PCM (8K)
Sample Rate	48 KHz
<b>Interface</b>	
Video Outputs	HDMI, IP, USB, 3G-SDI
Audio Outputs	HDMI, IP, USB
Audio Inputs	MIC in, Line in
<b>General</b>	
Power Requirement	AC 100 - 240V to DC 12V/2A or above
Power Consumption	18W
PoE	PoE+
Dimensions (W x D x H)	W180*D145*H183.5mm
Net Weight	1.7 (±0.1) kg
Application	Indoor
Tally	Yes
Security	Kensington Slot
Remote Control	Infrared

Operating Conditions	Temperature : 0 °C to +40 °C ; Humidity : 20% to 80%
Storage Conditions	Temperature : -20°C to +60°C ; Humidity: 20% to 95%
<b>IP Streaming</b>	
Resolution	1080p 60fps
Network Video Compress Formats	H.264, H.265, MJPEG
Maximum Frame Rate	1080p 60fps
Bit-rate Control Modes	VBR, CBR (selectable)
Range of Bit-rate Setting	512 Kbps to 32 Mbps
Network Interface	10 / 100 / 1000 Base-T
Multi-stream Capability	2 (RTSP / Web Page), 1080p 60fps (max.)
Network Protocols	IPv6, IPv4, TCP, UDP, ARP, ICMP, IGMP, HTTP, DHCP, RTP / RTCP, RTSP, RTMP, VISCA over IP
NDI®   HX Capability	No
<b>USB</b>	
Connector	USB 3.0
Video Format	MJPEG
Maximum Video Resolution	1080p
USB Video Class (UVC)	UVC 1.1
<b>Web UI</b>	
Live Video Preview	Yes
Camera PTZ Control	Pan, Tilt, Zoom, Focus, Preset Control
Camera / Image Adjustment	Exposure, White Balance, Picture
Network Configuration	DHCP, IP Address, Gateway, Subnet Mask, DNS
<b>Software Tools</b>	
Device IP Searching, Configuration Tool	Support Windows® 7 or later

Warranty	
Camera	3 Years
Accessories	1 Year

## PTC310H

Camera	
Image Sensor	1/2.8" 4K Exmor CMOS
Effective Picture Elements	8 Megapixels
Output Resolutions	Auto 2160p/30, 2160p/25, 2160p/29.97, 1080p/60, 1080p/59.94, 1080p/50, 1080p/30, 1080p/29.97, 1080p/25, 720p/60, 720p/59.94, 720p/50, 720p/30, 720p/29.97, 720p/25
Minimum Illumination	0.4 lux (IRE50, F1.6, 30fps)
S/N Ratio	≥ 50 dB
Gain	Auto, Manual
TV Line	1400 (Center)
Shutter Speed	1/1 s to 1/10,000 sec
Exposure Control	Auto, Manual, Bright mode, Priority AE (Shutter, IRIS), BLC, WDR
White Balance	Auto, ATW, Indoor, Outdoor, One push, Manual
Optical Zoom	12X
Digital Zoom	12X
Sensor Zoom	2X
Viewing Angles	DFOV : 78° (Wide) to 7° (Tele) HFOV : 70° (Wide) to 6° (Tele) VFOV : 42° (Wide) to 3° (Tele)
Focal Length	f = 3.9 mm (Wide) to 46.8 mm (Tele)
Aperture (Iris)	F = 1.6 (Wide) to 2.8 (Tele)
Minimum Working Distance	0.3 m (Wide), 1.5 m (Tele)

<b>Camera</b>	
Pan / Tilt Angles	Pan : $\pm 170^\circ$ , Tilt : $+90^\circ / -30^\circ$
Pan / Tilt Speed (Manual)	Pan : $0.1^\circ$ to $100^\circ / \text{sec}$ , Tilt : $0.1^\circ$ to $100^\circ / \text{sec}$
Preset Speed	Pan : $200^\circ / \text{sec}$ , Tilt : $200^\circ / \text{sec}$
Preset Positions	10 (IR), 255 (RS-232)
Camera Control - Interface	RS-232 (DIN8), RS-422 (RJ45), IP
Camera Control - Protocols	VISCA / PELCO-D (RS-232 / RS-422 / IP), CGI (IP)
Image Processing	Noise Reduction (2D / 3D), Flip, Mirror
Power Frequency	50 Hz, 60 Hz
<b>AI Auto Tracking Functions</b>	
Tracking Mode	Presenter Mode, Zone Mode
<b>Audio</b>	
Channel	2ch Stereo
Codec	AAC (48 / 44.1 / 32 / 24K), G.711, PCM (8K)
Sample Rate	48 KHz
<b>Interface</b>	
Video Outputs	HDMI, IP, USB
Audio Outputs	HDMI, IP, USB
Audio Inputs	MIC in, Line in
<b>General</b>	
Power Requirement	AC 100 - 240V to DC 12V/2A and above
Power Consumption	18W
PoE	PoE+
Dimensions (W x D x H)	W180*D145*H183.5mm
Net Weight	1.7 ( $\pm 0.1$ ) kg
Application	Indoor
Tally	Yes

Security	Kensington Slot
Remote Control	Infrared
Operating Conditions	Temperature : 0 °C to +40 °C ; Humidity : 20% to 80%
Storage Conditions	Temperature : -20°C to +60°C ; Humidity: 20% to 95%
<b>IP Streaming</b>	
Resolution	4K 30fps, 1080p 60fps
Network Video Compress Formats	H.264, H.265, MJPEG
Maximum Frame Rate	4K 30fps, 1080p 60fps
Bit-rate Control Modes	VBR, CBR (selectable)
Range of Bit-rate Setting	512 Kbps to 32 Mbps
Network Interface	10 / 100 / 1000 Base-T
Multi-stream Capability	2 (RTSP / Web Page), 1080p 60fps (max.)
Network Protocols	IPv6, IPv4, TCP, UDP, ARP, ICMP, IGMP, HTTP, DHCP, RTP / RTCP, RTSP, RTMP, VISCA over IP, SRT
NDI®   HX Capability	No
<b>USB</b>	
Connector	USB 3.0
Video Format	MJPEG
Maximum Video Resolution	1080p
USB Video Class (UVC)	UVC 1.1

Web UI	
Live Video Preview	Yes
Camera PTZ Control	Pan, Tilt, Zoom, Focus, Preset Control
Camera / Image Adjustment	Exposure, White Balance, Picture
Network Configuration	DHCP, IP Address, Gateway, Subnet Mask, DNS
Software Tools	
Device IP Searching, Configuration Tool	Support Windows® 7 or later
Warranty	
Camera	3 Years
Accessories	1 Year

## PTC310N

Camera	
Image Sensor	1/2.8" 1080p Exmor CMOS
Effective Picture Elements	2 Megapixels
Output Resolutions	Auto 1080p/60, 1080p/59.94, 1080p/50, 1080p/30, 1080p/29.97, 1080p/25, 720p/60, 720p/59.94, 720p/50, 720p/30, 720p/29.97, 720p/25
Minimum Illumination	0.4 lux (IRE50, F1.6, 30fps)
S/N Ratio	≥ 50 dB
Gain	Auto, Manual
TV Line	900 (Center)
Shutter Speed	1/1 s to 1/10,000 sec
Exposure Control	Auto, Manual, Bright mode, Priority AE (Shutter, IRIS), BLC, WDR
White Balance	Auto, ATW, Indoor, Outdoor, One push, Manual
Optical Zoom	12X



Digital Zoom	12X
Sensor Zoom	2X
Viewing Angles	DFOV : 78° (Wide) to 7° (Tele) HFOV : 70° (Wide) to 6° (Tele) VFOV : 42° (Wide) to 3° (Tele)
Focal Length	f = 3.9 mm (Wide) to 46.8 mm (Tele)
Aperture (Iris)	F = 1.6 (Wide) to 2.8 (Tele)
Minimum Working Distance	0.3 m (Wide), 1.5 m (Tele)
<b>Camera</b>	
Pan / Tilt Angles	Pan : ±170°, Tilt : +90° / -30°
Pan / Tilt Speed (Manual)	Pan : 0.1° to 100° / sec, Tilt : 0.1° to 100° / sec
Preset Speed	Pan : 200° / sec, Tilt : 200° / sec
Preset Positions	10 (IR), 255 (RS-232)
Camera Control - Interface	RS-232 (DIN8), RS-422 (RJ45), IP
Camera Control - Protocols	VISCA / PELCO-D (RS-232 / RS-422 / IP), CGI (IP)
Image Processing	Noise Reduction (2D / 3D), Flip, Mirror
Power Frequency	50 Hz, 60 Hz
<b>AI Auto Tracking Functions</b>	
Tracking Mode	Presenter Mode, Zone Mode
<b>Audio</b>	
Channel	2ch Stereo
Codec	AAC (48 / 44.1 / 32 / 24K), G.711, PCM (8K)
Sample Rate	48 KHz
<b>Interface</b>	
Video Outputs	3G-SDI, HDMI, IP, USB
Audio Outputs	3G-SDI, HDMI, IP, USB
Audio Inputs	MIC in, Line in
<b>General</b>	

Power Requirement	AC 100 - 240V to DC 12V/2A and above
Power Consumption	18W
PoE	PoE+
Dimensions (W x D x H)	W180*D145*H183.5mm
Net Weight	1.7 (±0.1) kg
<b>General</b>	
Application	Indoor
Tally	Yes
Security	Kensington Slot
Remote Control	Infrared
Operating Conditions	Temperature : 0 °C to +40 °C ; Humidity : 20% to 80%
Storage Conditions	Temperature : -20°C to +60°C ; Humidity: 20% to 95%
<b>IP Streaming</b>	
Resolution	1080p 60fps
Network Video Compress Formats	H.264, H.265, MJPEG, NDI
Maximum Frame Rate	1080p 60fps
Bit-rate Control Modes	VBR, CBR (selectable)
Range of Bit-rate Setting	512 Kbps to 32 Mbps
Network Interface	10 / 100 / 1000 Base-T
Multi-stream Capability	2 (RTSP / Web Page), 1080p 60fps (max.)
Network Protocols	IPv6, IPv4, TCP, UDP, ARP, ICMP, IGMP, HTTP, DHCP, RTP / RTCP, RTSP, RTMP, VISCA over IP, SRT, NDI
NDI®   HX Capability	Yes
<b>USB</b>	
Connector	USB 3.0

Video Format	MJPEG
Maximum Video Resolution	1080p
USB Video Class (UVC)	UVC 1.1
<b>Web UI</b>	
Live Video Preview	Yes
Camera PTZ Control	Pan, Tilt, Zoom, Focus, Preset Control
Camera / Image Adjustment	Exposure, White Balance, Picture
Network Configuration	DHCP, IP Address, Gateway, Subnet Mask, DNS
<b>Software Tools</b>	
Device IP Searching, Configuration Tool	Support Windows® 7 or later
<b>Warranty</b>	
Camera	3 Years
Accessories	1 Year

# PTC310U

Camera	
Image Sensor	1/2.8" 4K Exmor CMOS
Effective Picture Elements	8 Megapixels
Output Resolutions	Auto 4K/30, 4K/29.97, 4K/25, 1080p/60, 1080p/59.94, 1080p/50, 1080p/30, 1080p/29.97, 1080p/25, 720p/60, 720p/59.94, 720p/50, 720p/30, 720p/29.97, 720p/25
Minimum Illumination	0.4 lux (IRE50, F1.6, 30fps)
S/N Ratio	≥ 50 dB
Gain	Auto, Manual
TV Line	1400 (Center)
Shutter Speed	1/1 s to 1/10,000 sec
Exposure Control	Auto, Manual, Bright mode, Priority AE (Shutter, IRIS), BLC, WDR
White Balance	Auto, ATW, Indoor, Outdoor, One push, Manual
Optical Zoom	12X
Digital Zoom	12X
Sensor Zoom	2X
Viewing Angles	DFOV : 78° (Wide) to 7° (Tele) HFOV : 70° (Wide) to 6° (Tele) VFOV : 42° (Wide) to 3° (Tele)
Focal Length	f = 3.9 mm (Wide) to 46.8 mm (Tele)
Aperture (Iris)	F = 1.6 (Wide) to 2.8 (Tele)
Minimum Working Distance	0.3 m (Wide), 1.5 m (Tele)
Pan / Tilt Angles	Pan : ±170°, Tilt : +90° / -30°
Pan / Tilt Speed (Manual)	Pan : 0.1° to 100° / sec, Tilt : 0.1° to 100° / sec

Camera	
Preset Speed	Pan : 200° / sec, Tilt : 200° / sec
Preset Positions	10 (IR), 255 (RS-232)
Camera Control - Interface	RS-232 (DIN8), RS-422 (RJ45), IP
Camera Control - Protocols	VISCA / PELCO-D (RS-232 / RS-422 / IP), CGI (IP)
Image Processing	Noise Reduction (2D / 3D), Flip, Mirror
Power Frequency	50 Hz, 60 Hz
AI Auto Tracking Functions	
Tracking Mode	Presenter Mode, Zone Mode
Audio	
Channel	2ch Stereo
Codec	AAC (48 / 44.1 / 32 / 24K), G.711, PCM (8K)
Sample Rate	48 KHz
Interface	
Video Outputs	3G-SDI, HDMI, IP, USB
Audio Outputs	3G-SDI, HDMI, IP, USB
Audio Inputs	MIC in, Line in
General	
Power Requirement	AC 100 - 240V to DC 12V/2A and above
Power Consumption	18W
PoE	PoE+
Dimensions (W x W x H)	W180*D145*H183.5mm
Net Weight	1.7 (±0.1) kg
Application	Indoor
Tally	Yes
Security	Kensington Slot

<b>General</b>	
Remote Control	Infrared
Operating Conditions	Temperature : 0 °C to +40 °C ; Humidity : 20% to 80%
Storage Conditions	Temperature : -20°C to +60°C ; Humidity: 20% to 95%
<b>IP Streaming</b>	
Resolution	4K 30fps
Network Video Compress Formats	H.264, H.265, MJPEG
Maximum Frame Rate	4K 30fps or 1080p 60fps
Bit-rate Control Modes	VBR, CBR (selectable)
Range of Bit-rate Setting	512 Kbps to 32 Mbps
Network Interface	10 / 100 / 1000 Base-T
Multi-stream Capability	2 (RTSP / Web Page), 1080p 60fps (max.)
Network Protocols	IPv6, IPv4, TCP, UDP, ARP, ICMP, IGMP, HTTP, DHCP, RTP / RTCP, RTSP, RTMP, VISCA over IP, SRT
NDI®   HX Capability	No
<b>USB</b>	
Connector	USB 3.0
Video Format	MJPEG
Maximum Video Resolution	2160p
USB Video Class (UVC)	UVC 1.1

Web UI	
Live Video Preview	Yes
Camera PTZ Control	Pan, Tilt, Zoom, Focus, Preset Control
Camera / Image Adjustment	Exposure, White Balance, Picture
Network Configuration	DHCP, IP Address, Gateway, Subnet Mask, DNS
Software Tools	
Device IP Searching, Configuration Tool	Support Windows® 7 or later
Warranty	
Camera	3 Years
Accessories	1 Year

## PTC310UN

Camera	
Image Sensor	1/2.8" 4K Exmor CMOS
Effective Picture Elements	8 Megapixels
Output Resolutions	Auto 4K/30, 4K/29.97, 4K/25, 1080p/60, 1080p/59.94, 1080p/50, 1080p/30, 1080p/29.97, 1080p/25, 720p/60, 720p/59.94, 720p/50, 720p/30, 720p/29.97, 720p/25
Minimum Illumination	0.4 lux (IRE50, F1.6, 30fps)
S/N Ratio	≥ 50 dB
Gain	Auto, Manual
TV Line	1400 (Center)
Shutter Speed	1/1 s to 1/10,000 sec
Exposure Control	Auto, Manual, Bright mode, Priority AE (Shutter, IRIS), BLC, WDR
White Balance	Auto, ATW, Indoor, Outdoor, One push, Manual

Optical Zoom	12X
Digital Zoom	12X
Sensor Zoom	2X
Viewing Angles	DFOV : 78° (Wide) to 7° (Tele) HFOV : 70° (Wide) to 6° (Tele) VFOV : 42° (Wide) to 3° (Tele)
Focal Length	f = 3.9 mm (Wide) to 46.8 mm (Tele)
Aperture (Iris)	F = 1.6 (Wide) to 2.8 (Tele)
Minimum Working Distance	0.3 m (Wide), 1.5 m (Tele)
Pan / Tilt Angles	Pan : $\pm 170^\circ$ , Tilt : $+90^\circ / -30^\circ$
Pan / Tilt Speed (Manual)	Pan : $0.1^\circ$ to $100^\circ / \text{sec}$ , Tilt : $0.1^\circ$ to $100^\circ / \text{sec}$



Camera	
Preset Speed	Pan : 200° / sec, Tilt : 200° / sec
Preset Positions	10 (IR), 255 (RS-232)
Camera Control - Interface	RS-232 (DIN8), RS-422 (RJ45), IP
Camera Control - Protocols	VISCA / PELCO-D (RS-232 / RS-422 / IP), CGI (IP)
Image Processing	Noise Reduction (2D / 3D), Flip, Mirror
Power Frequency	50 Hz, 60 Hz
AI Auto Tracking Functions	
Tracking Mode	Presenter Mode, Zone Mode
Audio	
Channel	2ch Stereo
Codec	AAC (48 / 44.1 / 32 / 24K), G.711, PCM (8K)
Sample Rate	48 KHz
Interface	
Video Outputs	3G-SDI, HDMI, IP, USB
Audio Outputs	3G-SDI, HDMI, IP, USB
Audio Inputs	MIC in, Line in
General	
Power Requirement	AC 100 - 240V to DC 12V/2A and above
Power Consumption	18W
PoE	PoE+
Dimensions (W x W x H)	W180*D145*H183.5mm
Net Weight	1.7 (±0.1) kg
Application	Indoor
Tally	Yes
Security	Kensington Slot

<b>General</b>	
Remote Control	Infrared
Operating Conditions	Temperature : 0 °C to +40 °C ; Humidity : 20% to 80%
Storage Conditions	Temperature : -20°C to +60°C ; Humidity: 20% to 95%
<b>IP Streaming</b>	
Resolution	4K 30fps
Network Video Compress Formats	H.264, H.265, MJPEG
Maximum Frame Rate	4K 30fps or 1080p 60fps
Bit-rate Control Modes	VBR, CBR (selectable)
Range of Bit-rate Setting	512 Kbps to 32 Mbps
Network Interface	10 / 100 / 1000 Base-T
Multi-stream Capability	2 (RTSP / Web Page), 1080p 60fps (max.)
Network Protocols	IPv6, IPv4, TCP, UDP, ARP, ICMP, IGMP, HTTP, DHCP, RTP / RTCP, RTSP, RTMP, VISCA over IP, SRT
NDI®   HX Capability	Yes
<b>USB</b>	
Connector	USB 3.0
Video Format	MJPEG
Maximum Video Resolution	2160p
USB Video Class (UVC)	UVC 1.1

Web UI	
Live Video Preview	Yes
Camera PTZ Control	Pan, Tilt, Zoom, Focus, Preset Control
Camera / Image Adjustment	Exposure, White Balance, Picture
Network Configuration	DHCP, IP Address, Gateway, Subnet Mask, DNS
Software Tools	
Device IP Searching, Configuration Tool	Support Windows® 7 or later
Warranty	
Camera	3 Years
Accessories	1 Year

## PTC330

Camera	
Image Sensor	1/2.5" 2M Exmor CMOS
Effective Picture Elements	2 Megapixels
Output Resolutions	Auto 1080p/60, 1080p/59.94, 1080p/50, 1080p/30, 1080p/29.97, 1080p/25, 720p/60, 720p/59.94, 720p/50, 720p/30, 720p/29.97, 720p/25
Minimum Illumination	0.7 lux (IRE50, F1.5, 30fps)
S/N Ratio	≥ 50 dB
Gain	Auto, Manual
TV Line	900 (center/wide)
Shutter Speed	1/1 to 1/32,000 sec
Exposure Control	Auto, Manual, Priority AE (Shutter, IRIS), BLC, WDR
White Balance	Auto, Manual

Optical Zoom	30X
Digital Zoom	12X
Sensor Zoom	2X
Viewing Angles	DFOV : 72.9° (Wide) to 2.64° (Tele) HFOV : 65.1° (Wide) to 2.34° (Tele) VFOV : 38.4° (Wide) to 1.36° (Tele)
Focal Length	f = 4.3 mm (Wide) to 129 mm (Tele)
Aperture (Iris)	F = 1.6 (Wide) to 4.7 (Tele)
Minimum Working Distance	Wide 0.01 m, Tele 1.2 m
Pan / Tilt Angles	Pan : ±170°, Tilt : +90° / -30°
Pan / Tilt Speed (Manual)	Pan : 0.1° to 100° / sec, Tilt : 0.1° to 100° / sec
<b>Camera</b>	
Preset Speed	Pan : 200° / sec, Tilt : 200° / sec
Preset Positions	10 (IR), 255 (RS-232)
Camera Control - Interface	RS-232 (DIN8), RS-422 (RJ45), IP
Camera Control - Protocols	VISCA / PELCO-D (RS-232 / RS-422 / IP), CGI (IP)
Image Processing	Noise Reduction (2D / 3D), Flip, Mirror
Power Frequency	50 Hz, 60 Hz
<b>AI Auto Tracking Functions</b>	
Tracking Mode	Presenter Mode, Zone Mode, Hybrid Mode
<b>Audio</b>	
Channel	2ch Stereo
Codec	AAC-LC (48 / 44.1 / 32 / 24K), G.711, PCM (8K)
Sample Rate	48 / 44.1 / 32 / 24 / 16 / 8 KHz
<b>Interface</b>	

Video Outputs	3G-SDI, HDMI, IP, USB
Audio Outputs	3G-SDI, HDMI, IP, USB
Audio Inputs	MIC in, Line in
<b>General</b>	
Power Requirement	AC 100 - 240V to DC 12V/2A and above
Power Consumption	18W
PoE	PoE+
Dimensions (W x D x H)	W180*D145*H183.5mm
Net Weight	1.7 (±0.1) kg
Application	Indoor
Tally	Yes
Security	Kensington Slot
Remote Control	Infrared
<b>General</b>	
Operating Conditions	Temperature : 0 °C to +40 °C ; Humidity : 20% to 80%
Storage Conditions	Temperature : -20°C to +60°C ; Humidity: 20% to 95%
<b>IP Streaming</b>	
Resolution	1080p60
Network Video Compress Formats	H.264, H.265, MJPEG
Maximum Frame Rate	1080p 60fps
Bit-rate Control Modes	VBR, CBR (selectable)
Range of Bit-rate Setting	512 Kbps to 32 Mbps
Network Interface	10 / 100 / 1000 Base-T
Multi-stream Capability	2 (RTSP / Web Page), 1080p 60fps (max.)
Network Protocols	IPv6, IPv4, TCP, UDP, ARP, ICMP, IGMP, HTTP, DHCP, RTP / RTCP, RTSP, RTMP, VISCA over IP

NDI®   HX Capability	No
<b>USB</b>	
Connector	USB 3.0
Video Format	MJPEG
Maximum Video Resolution	1080p
USB Video Class (UVC)	UVC 1.1
USB Audio Class (UAC)	UAC 1.0
<b>Web UI</b>	
Live Video Preview	Yes
Camera PTZ Control	Pan, Tilt, Zoom, Focus, Preset Control
Camera / Image Adjustment	Exposure, White Balance, Picture
Network Configuration	DHCP, IP Address, Gateway, Subnet Mask, DNS
<b>Software Tools</b>	
Device IP Searching, Configuration Tool	Support Windows® 7 or later
<b>Warranty</b>	
Camera	3 Years
Accessories	1 Year

## PTC330N

<b>Camera</b>	
Image Sensor	1/2.5" 2M Exmor CMOS
Effective Picture Elements	2 Megapixels
Output Resolutions	Auto 1080p/60, 1080p/59.94, 1080p/50, 1080p/30, 1080p/29.97, 1080p/25, 720p/60, 720p/59.94, 720p/50, 720p/30, 720p/29.97, 720p/25
Minimum Illumination	0.7 lux (IRE50, F1.5, 30fps)

S/N Ratio	≥ 50 dB
Gain	Auto, Manual
TV Line	900 (center/wide)
Shutter Speed	1/1 to 1/32,000 sec
Exposure Control	Auto, Manual, Priority AE (Shutter, IRIS), BLC, WDR
White Balance	Auto, Manual
Optical Zoom	30X
Digital Zoom	12X
Sensor Zoom	2X
Viewing Angles	DFOV : 72.9° (Wide) to 2.64° (Tele) HFOV : 65.1° (Wide) to 2.34° (Tele) VFOV : 38.4° (Wide) to 1.36° (Tele)
Focal Length	f = 4.3 mm (Wide) to 129 mm (Tele)
Aperture (Iris)	F = 1.6 (Wide) to 4.7 (Tele)
Minimum Working Distance	Wide 0.01 m, Tele 1.2 m
Pan / Tilt Angles	Pan : ±170°, Tilt : +90° / -30°
Pan / Tilt Speed (Manual)	Pan : 0.1° to 100° / sec, Tilt : 0.1° to 100° / sec
<b>Camera</b>	
Preset Speed	Pan : 200° / sec, Tilt : 200° / sec
Preset Positions	10 (IR), 255 (RS-232)
Camera Control - Interface	RS-232 (DIN8), RS-422 (RJ45), IP
Camera Control - Protocols	VISCA / PELCO-D (RS-232 / RS-422 / IP), CGI (IP)
Image Processing	Noise Reduction (2D / 3D), Flip, Mirror
Power Frequency	50 Hz, 60 Hz

<b>AI Auto Tracking Functions</b>	
Tracking Mode	Presenter Mode, Zone Mode, Hybrid Mode
<b>Audio</b>	
Channel	2ch Stereo
Codec	AAC-LC (48 / 44.1 / 32 / 24K), G.711, PCM (8K)
Sample Rate	48 / 44.1 / 32 / 24 / 16 / 8 KHz
<b>Interface</b>	
Video Outputs	3G-SDI, HDMI, IP, USB
Audio Outputs	3G-SDI, HDMI, IP, USB
Audio Inputs	MIC in, Line in
<b>General</b>	
Power Requirement	AC 100 - 240V to DC 12V/2A and above
Power Consumption	18W
PoE	PoE+
Dimensions (W x D x H)	W180*D145*H183.5mm
Net Weight	1.7 (±0.1) kg
Application	Indoor
Tally	Yes
Security	Kensington Slot
Remote Control	Infrared
<b>General</b>	
Operating Conditions	Temperature : 0 °C to +40 °C ; Humidity : 20% to 80%
Storage Conditions	Temperature : -20°C to +60°C ; Humidity: 20% to 95%
<b>IP Streaming</b>	
Resolution	1080p60
Network Video Compress Formats	H.264, H.265, MJPEG
Maximum Frame Rate	1080p 60fps



Bit-rate Control Modes	VBR, CBR (selectable)
Range of Bit-rate Setting	512 Kbps to 32 Mbps
Network Interface	10 / 100 / 1000 Base-T
Multi-stream Capability	2 (RTSP / Web Page), 1080p 60fps (max.)
Network Protocols	IPv6, IPv4, TCP, UDP, ARP, ICMP, IGMP, HTTP, DHCP, RTP / RTCP, RTSP, RTMP, VISCA over IP
NDI®   HX Capability	Yes
<b>USB</b>	
Connector	USB 3.0
Video Format	MJPEG
Maximum Video Resolution	1080p
USB Video Class (UVC)	UVC 1.1
USB Audio Class (UAC)	UAC 1.0
<b>Web UI</b>	
Live Video Preview	Yes
Camera PTZ Control	Pan, Tilt, Zoom, Focus, Preset Control
Camera / Image Adjustment	Exposure, White Balance, Picture
Network Configuration	DHCP, IP Address, Gateway, Subnet Mask, DNS
<b>Software Tools</b>	
Device IP Searching, Configuration Tool	Support Windows® 7 or later
<b>Warranty</b>	
Camera	3 Years
Accessories	1 Year

## PTC330U

Camera	
Image Sensor	1/2.5" 4K Exmor CMOS
Effective Picture Elements	8 Megapixels
Output Resolutions	Auto 4K/30, 4K/29.97, 4K/25, 1080p/60, 1080p/59.94, 1080p/50, 1080p/30, 1080p/29.97, 1080p/25, 720p/60, 720p/59.94, 720p/50, 720p/30, 720p/29.97, 720p/25
Minimum Illumination	2.7 lux (IRE50, F1.5, 30fps)
S/N Ratio	≥ 50 dB
Gain	Auto, Manual
TV Line	1400 (Center)
Shutter Speed	1/1 to 1/32,000 sec
Exposure Control	Auto, Manual, Priority AE (Shutter, IRIS), BLC, WDR
White Balance	Auto, Manual
Optical Zoom	30X
Digital Zoom	12X
Sensor Zoom	2X
Viewing Angles	DFOV : 75° (Wide) to 3° (Tele) HFOV : 68° (Wide) to 2.8° (Tele) VFOV : 40° (Wide) to 1.6° (Tele)
Focal Length	f = 4.8 mm (Wide) to 144 mm (Tele)
Aperture (Iris)	F = 1.5 (Wide) to 3.4 (Tele)
Minimum Working Distance	1.5 m to Infinity
Pan / Tilt Angles	Pan : ±170°, Tilt : +90° / -30°
Pan / Tilt Speed (Manual)	Pan : 0.1° to 100° / sec, Tilt : 0.1° to 100° / sec

Camera	
Preset Speed	Pan : 200° / sec, Tilt : 200° / sec
Preset Positions	10 (IR), 255 (RS-232)
Camera Control - Interface	RS-232 (DIN8), RS-422 (RJ45), IP
Camera Control - Protocols	VISCA / PELCO-D (RS-232 / RS-422 / IP), CGI (IP)
Image Processing	Noise Reduction (2D / 3D), Flip, Mirror
Power Frequency	Auto, 50 Hz, 60 Hz
AI Auto Tracking Functions	
Tracking Mode	Presenter Mode, Zone Mode
Audio	
Channel	2ch Stereo
Codec	AAC-LC (48 / 44.1 / 32 / 24K), G.711, PCM (8K)
Sample Rate	48 / 44.1 / 32 / 24 / 16 / 8 KHz
Interface	
Video Outputs	3G-SDI, HDMI, IP, USB
Audio Outputs	3G-SDI, HDMI, IP, USB
Audio Inputs	MIC in, Line in
General	
Power Requirement	AC 100 - 240V to DC 12V/2A and above
Power Consumption	18W
PoE	PoE+
Dimensions (W x D x H)	W180*D145*H183.5mm
Net Weight	1.7 (±0.1) kg
Application	Indoor
Tally	Yes
Security	Kensington Slot
Remote Control	Infrared

General	
Operating Conditions	Temperature : 0 °C to +40 °C ; Humidity : 20% to 80%
Storage Conditions	Temperature : -20°C to +60°C ; Humidity: 20% to 95%
IP Streaming	
Resolution	4K 30fps
Network Video Compress Formats	H.264, H.265, MJPEG
Maximum Frame Rate	4K 30fps or 1080p 60fps
Bit-rate Control Modes	VBR, CBR (selectable)
Range of Bit-rate Setting	512 Kbps to 32 Mbps
Network Interface	10 / 100 / 1000 Base-T
Multi-stream Capability	2 (RTSP / Web Page), 1080p 60fps (max.)
Network Protocols	IPv6, IPv4, TCP, UDP, ARP, ICMP, IGMP, HTTP, DHCP, RTP / RTCP, RTSP, RTMP, VISCA over IP
NDI®   HX Capability	No
USB	
Connector	USB 3.0
Video Format	MJPEG
Maximum Video Resolution	2160p
USB Video Class (UVC)	UVC 1.1
USB Audio Class (UAC)	UAC 1.0
Web UI	
Live Video Preview	Yes
Camera PTZ Control	Pan, Tilt, Zoom, Focus, Preset Control
Camera / Image Adjustment	Exposure, White Balance, Picture
Network Configuration	DHCP, IP Address, Gateway, Subnet Mask, DNS

Software Tools	
Device IP Searching, Configuration Tool	Support Windows® 7 or later
Warranty	
Camera	3 Years
Accessories	1 Year

