

# SCREEN CONFIGURATION SUMMARY

SCREEN: 4051408602910

DELUXX Cinema Electric High Contrast Screen Tension II 220 x 124 cm, 100" - DAYVISION ALR

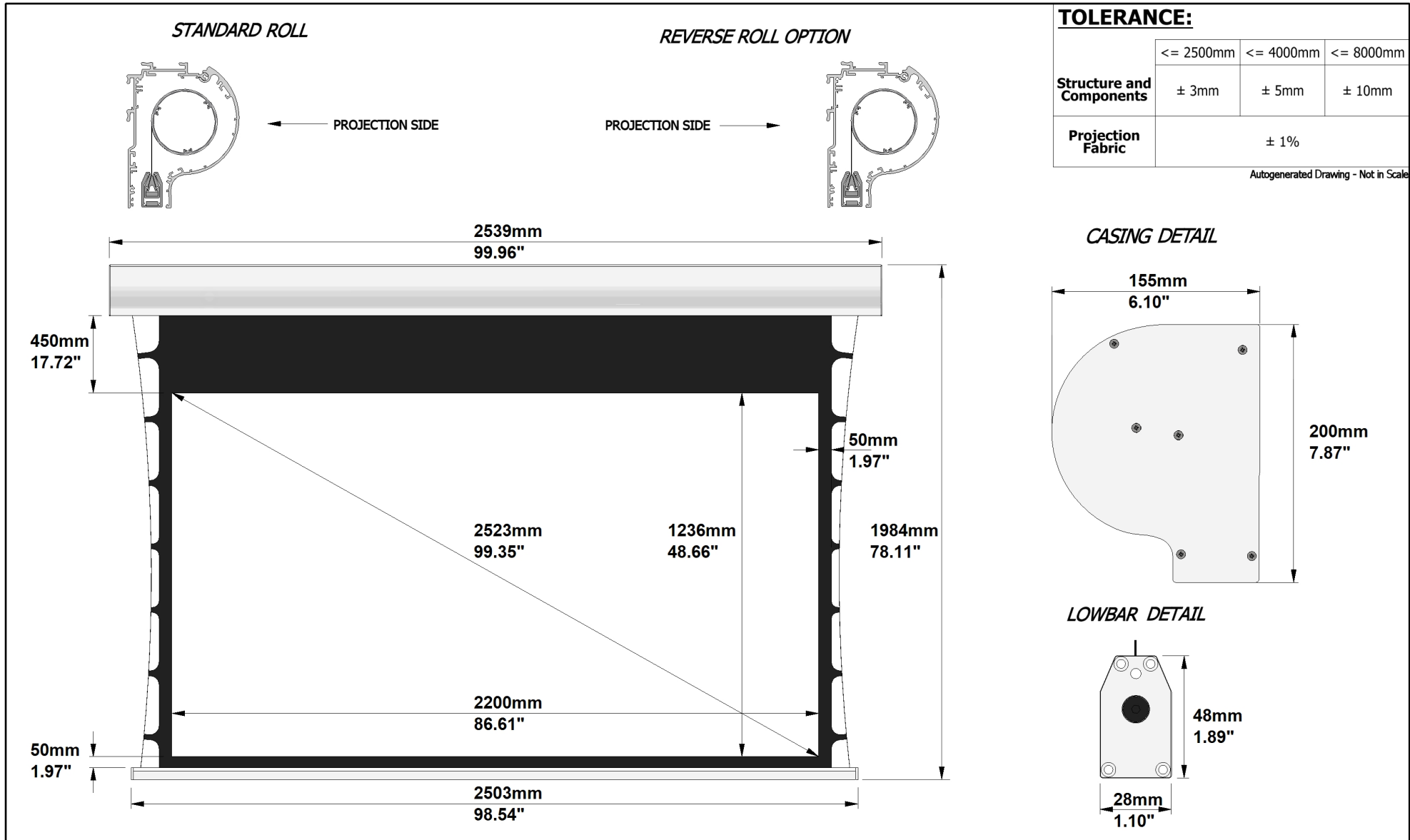

**TOLERANCE:**

	<= 2500mm	<= 4000mm	<= 8000mm
<b>Structure and Components</b>	± 3mm	± 5mm	± 10mm
<b>Projection Fabric</b>	± 1%		

Autogenerated Drawing - Not in Scale

# SCREEN CONFIGURATION SUMMARY

SCREEN: 4051408602910

DELUXX Cinema Electric High Contrast Screen Tension II 220 x 124 cm, 100" - DAYVISION ALR

Autogenerated Drawing - Not in Scale

## MOUNTING BRACKETS AND INSTALLATION VIEW:

QUANTITY OF BRACKETS FOR SCREEN
2

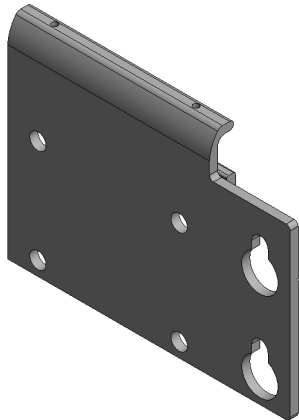
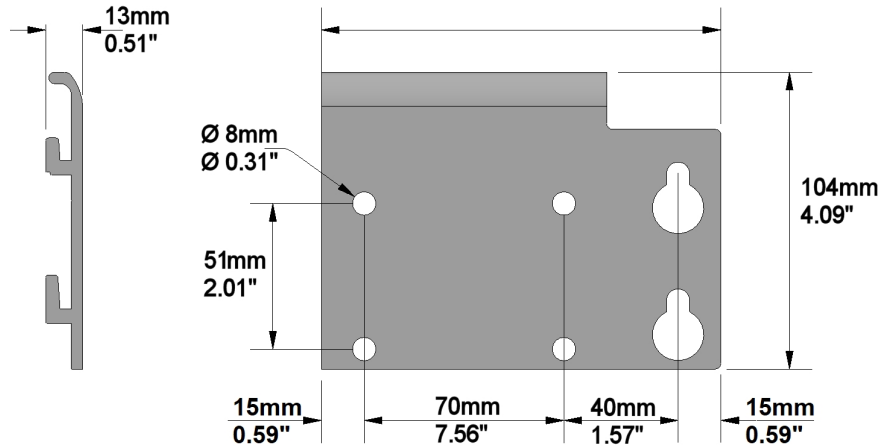

**! IMPORTANT: BRACKET SECURING SCREWS MUST BE USED. NOT DOING SO RISKS CASING FALLING !**

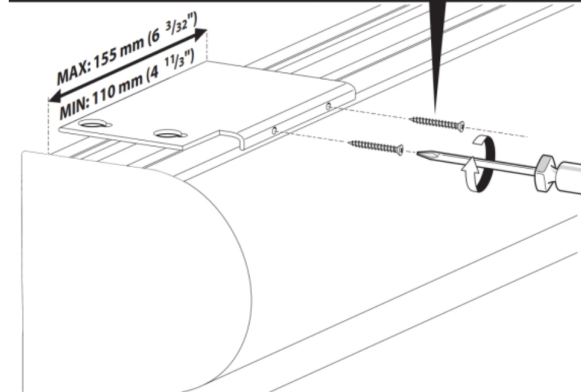

## PACKAGING INFORMATION:

	SHIPPING DIMENSIONS				NUMBER OF BOXES	TOTAL SHIPPING WEIGHT	
	LENGTH	DEPTH	HEIGHT	PALLET HEIGHT		kg	lbs
mm	2619mm			110mm	1	kg	51.90
inches	103.11"			4.33"		lbs	114.18

## MOUNTING OPTIONS:

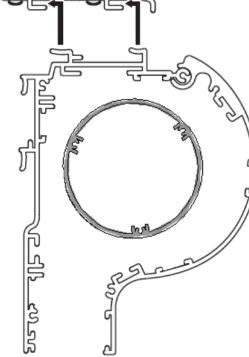
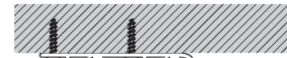

**Ceiling Mounting**

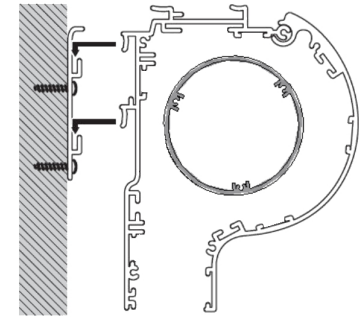

**Wall Mounting**

## MINIMUM CLEARANCE FOR WALL OR CEILING MOUNTING:

**Wall Mount:**  
min 0.51"  
min 13mm

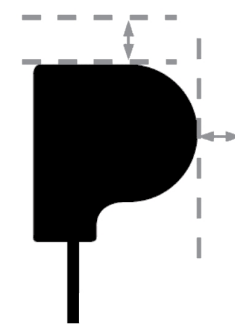

**Ceiling Mount:**  
min 0.51"  
min 13mm