

# Installationsanleitung

## MeetUp Display-Adapter 55 - 75“ Art.-Nr.: 2278

DE Installationsanleitung

GB Installation manual

FR Guide d'installation

NL Installatievoorschrift

ES Guía de instalación

SE Installationsanvisning

TR Yükleme Rehberi

RU инструкция по установке

CN 安装指南

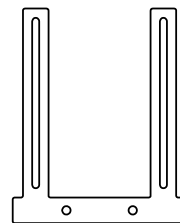
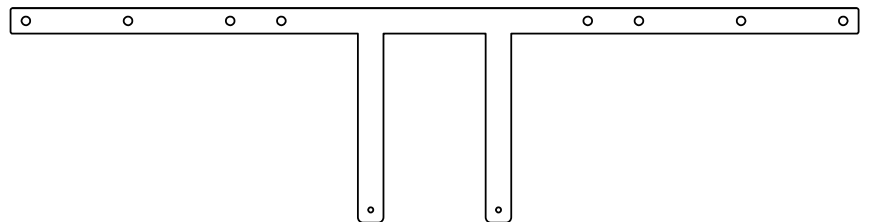

**DE**

### **Achtung!**

Technische Geräte stellen einen beträchtlichen Wert dar. Sie sollten daher bei der Installation vorsichtig mit den Komponenten umgehen und diese bei Bedarf schützen.

Auch sollte, falls nötig, der Installtionsbereich abgesichert werden. Herabfallende Teile können zu Verletzungen und Materialschäden führen.

Die im Lieferumfang enthaltenen Materialien sind unter Umständen nicht für die speziellen Gegebenheiten am Installationsort geeignet. Bitte prüfen Sie dies vorab und ersetzen Sie diese bei Bedarf durch geeignete Materialien.

Falls Sie Bezüglich der Installation des Produkts unsicher sind oder noch Fragen haben wenden Sie sich an uns oder anderes ausgebildetes Fachpersonal.

**GB**

### **Caution!**

Technical devices are of considerable value. You should therefore handle the components carefully during installation and protect them if necessary.

If necessary, the installation area should also be secured. Falling parts can cause injuries and material damage.

The materials included in the scope of delivery may not be suitable for the special conditions at the installation site. Please check this in advance and replace it with suitable materials if necessary.

If you are unsure about the installation of the product or have any questions, please contact us or other trained specialists.

# Lieferumfang | Scope of delivery

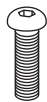
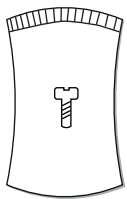
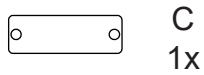
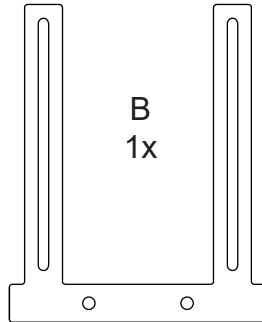
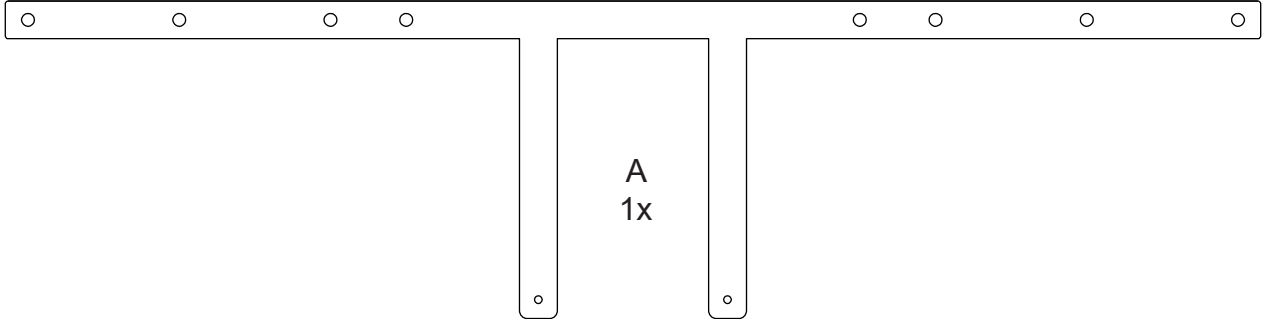

D  
1x

E  
2x  
M6x12

F  
2x  
M8x20

G  
2x  
M6

H  
4x  
M8  
(Kunststoff | plastic)

1

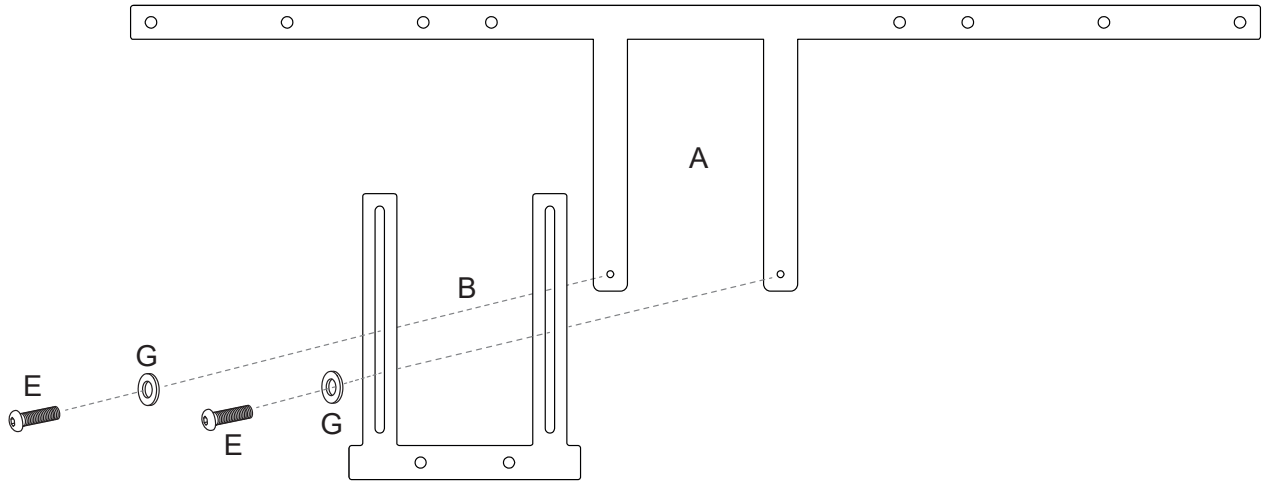

2

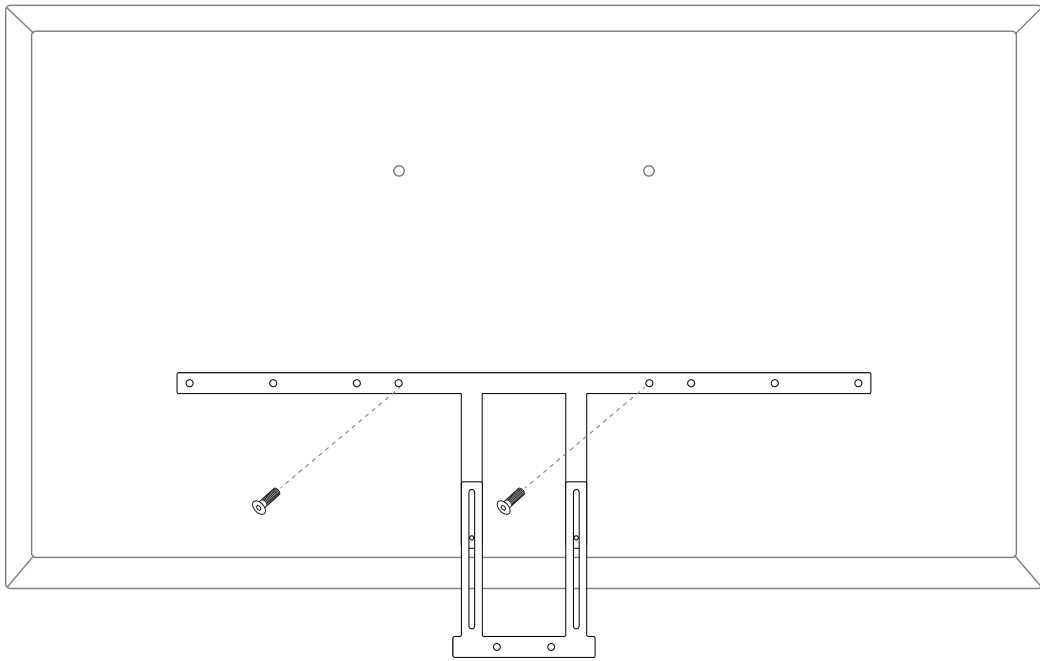

D

3

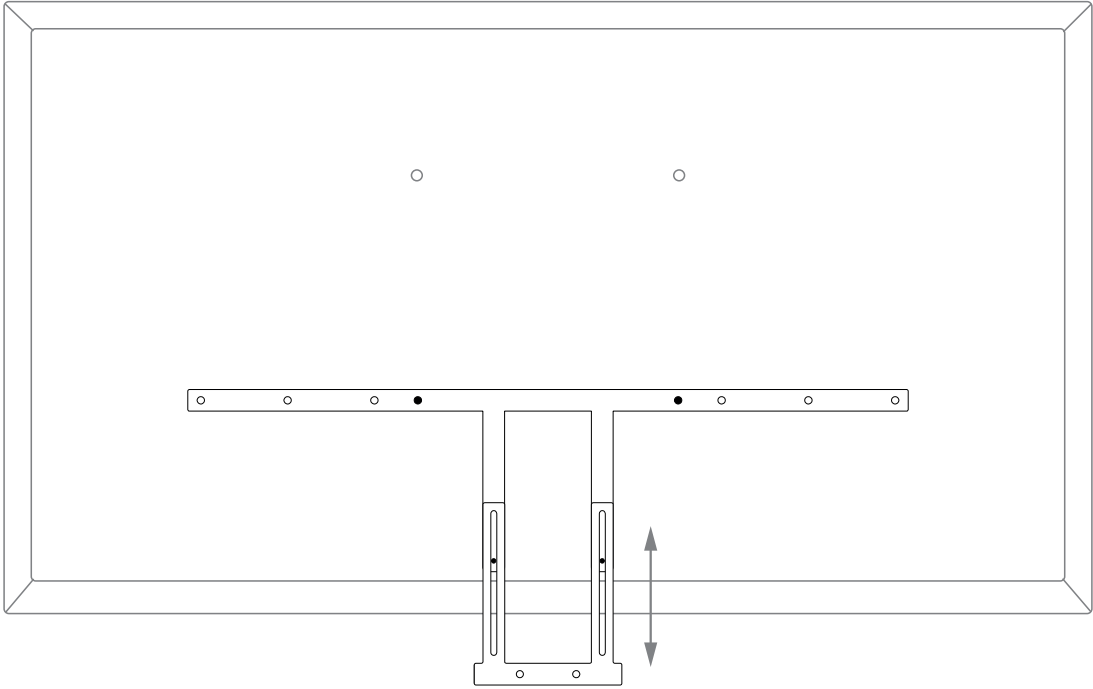

4

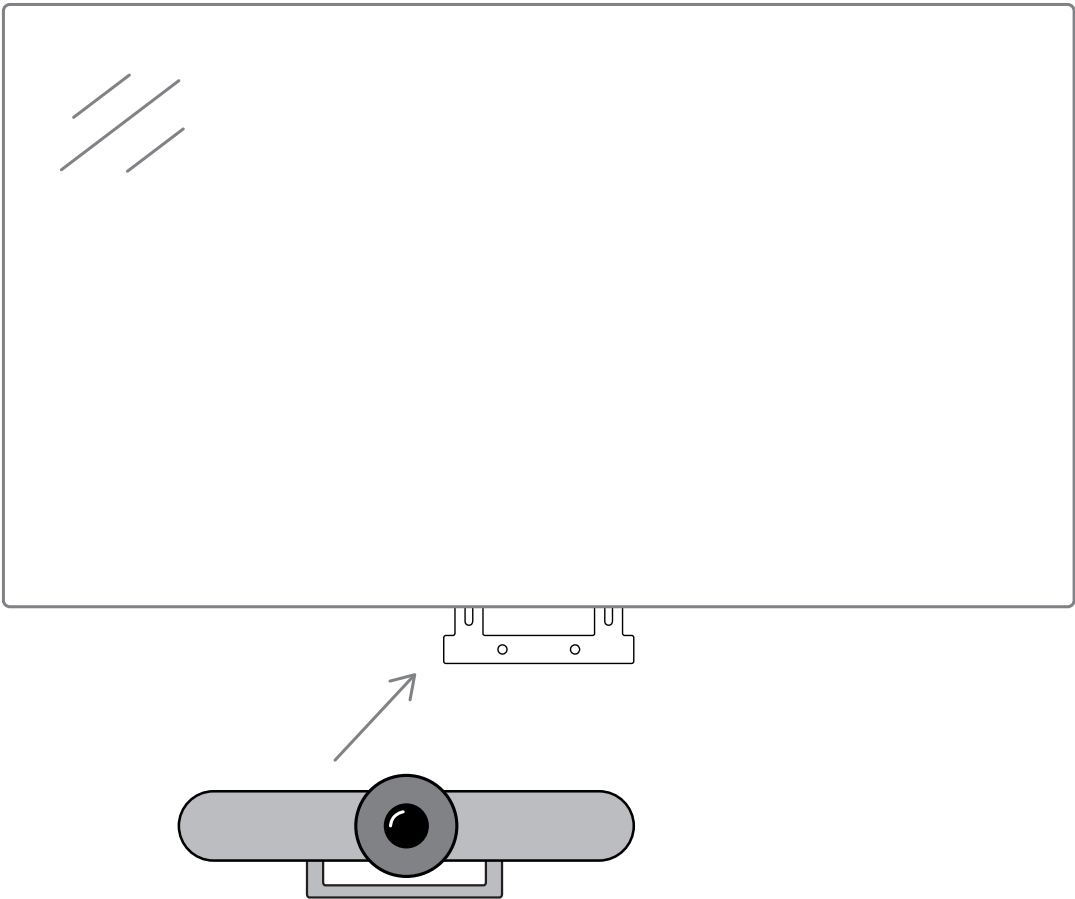

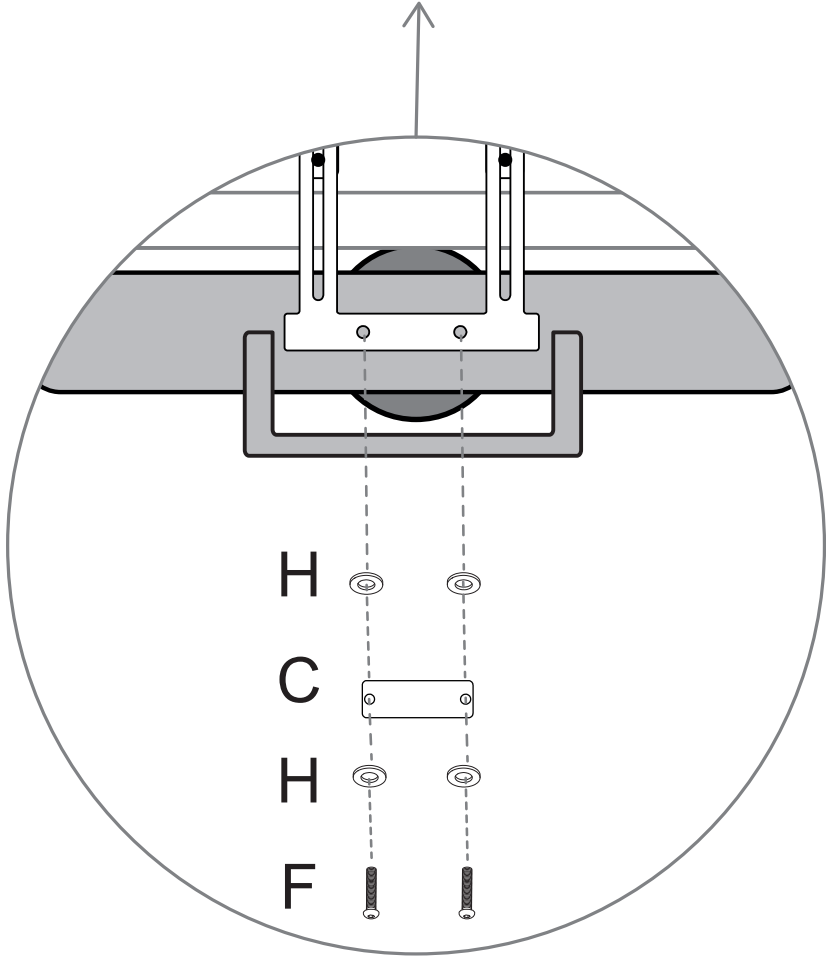
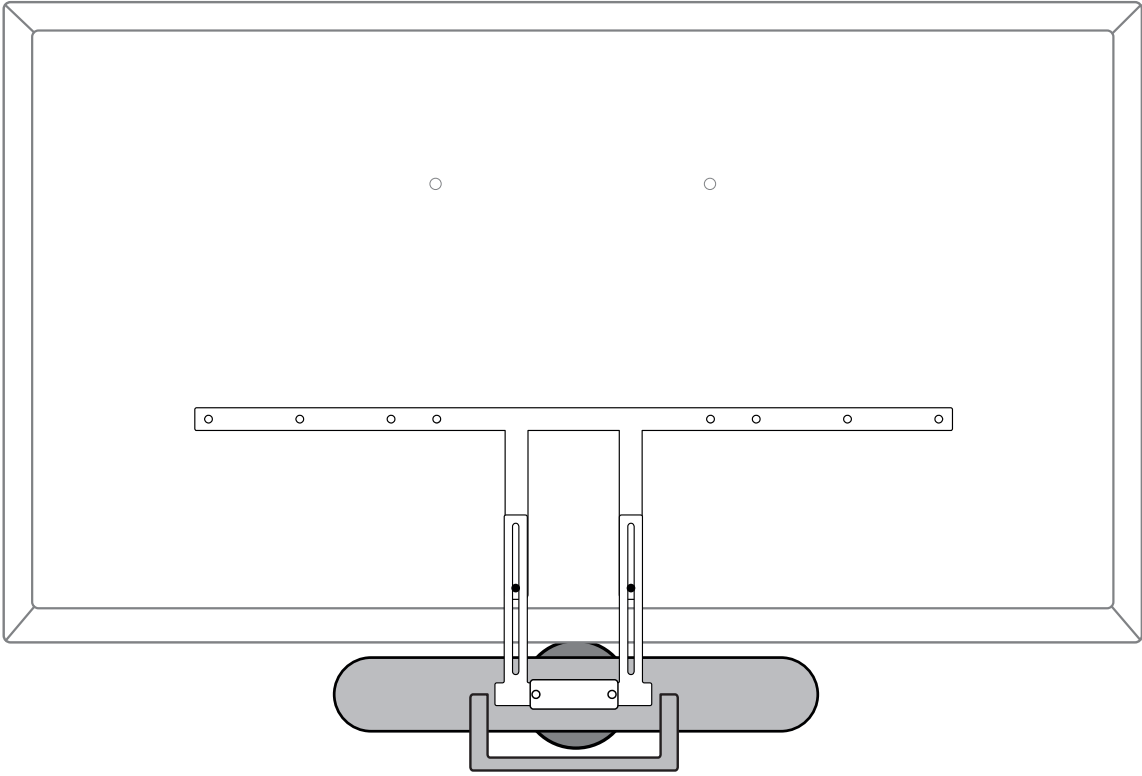

# Abmessungen | Dimensions

