

SONY

VPL-VW590ES

Bring An Incredible HDR Experience
to Your Favourite Movies



SXR D

X1
for projector

At a glance

- Native 4K resolution: 4096x2160
- 1,800 ANSI lumens
- Advanced 3 panel SXR D technology
- 350,000:1 dynamic contrast with dynamic iris
- 'X1 for Projector' picture processing
- Dynamic HDR Enhancer for spectacular HDR images
- Digital Focus Optimizer (DFO) for enhanced corner to corner clarity

Experience the beauty of Native 4K HDR images with the Sony VPL-VW590ES Home Cinema Projector, packed with 1,800 lumens of brightness, Dynamic HDR Enhancer and Digital Focus Optimizer functions. Designed for your home theater room and living room, this compact projector provides an immersive home theater experience with stunning detail and rich, faithful color making you feel as though you're right in the middle of the action.

Dynamic HDR Enhancer

Deliver the optimal projected HDR experience through Sony's advanced scene by scene HDR processing. Achieve striking highlights whilst maintaining deep black levels.

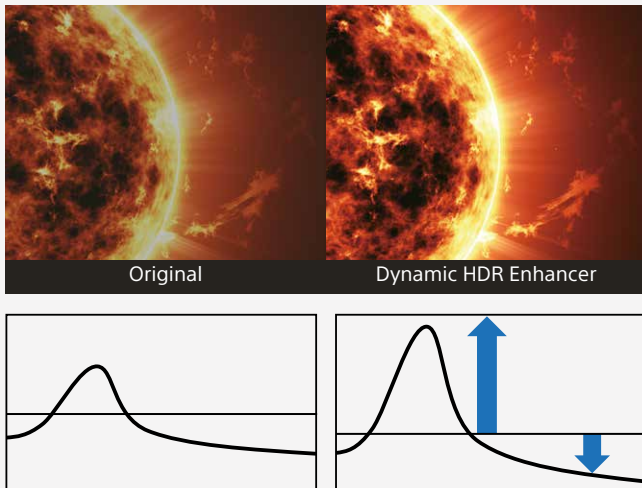

Native 4K SXR D™ panel

Sony's advanced SXR D (Silicon X-tal Reflective Display) panel technology featured in Sony's digital cinema projectors delivers native 4K (4096 x 2160) resolution images, with more than four times the detail of Full HD. Fine details are wonderfully clear and natural, without jagged edges or visible pixels.



Digital Focus Optimizer

Optimum focus is achieved not only optically, but also digitally. By analyzing every pixel of the images with our own algorithm and detecting possible degradation in advance, the Digital Focus Optimizer performs optimum image quality correction so that the focus is better than ever, even in the corners.

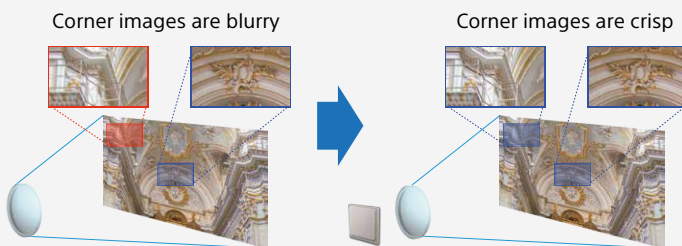

Picture Position Memory Matches Movie Aspect Ratio

The projector has a set of memory registers to store the position of the lens (focus, zoom, shift). Users can match a movie's aspect ratio, including 1.78:1 and 2.35:1, and store these settings in the projector for easy recall.

Screen 2.35:1



Screen 2.35:1



2.35:1 without picture position memory

Screen 2.35:1



2.35:1 with picture position memory

Specifications

		VPL-VW590ES
Display system		4K SXRD panel, projection system
Display device	Size of effective display area	0.74" x 3
	Number of pixels	26,542,080 (4096 x 2160 x 3) pixels
Projection lens	Focus	Powered
	Zoom	Powered (Approx. x 2.06)
	Lens shift	Powered, Vertical: +85 % -80 %, Horizontal: +/-31 %
		-
Throw ratio	1.38 : 1 to 2.83 : 1	
		-
Light source		High-pressure mercury lamp, 280 W type
Recommended lamp replacement time		6000 H (Lamp mode: Low)
Light output		1800 lm (Lamp mode: High)
Dynamic contrast		350,000:1
Accepted digital signals		720 x 576/50p, 720 x 480/60p, 1280 x 720/50p, 1280 x 720/60p, 1920 x 1080/50i, 1920 x 1080/60i, 1920 x 1080/24p, 1920 x 1080/50p, 1920 x 1080/60p, 3840 x 2160/24p, 3840 x 2160/25p, 3840 x 2160/30p, 3840 x 2160/50p, 3840 x 2160/60p, 4096 x 2160/24p, 4096 x 2160/25p, 4096 x 2160/30p, 4096 x 2160/50p, 4096 x 2160/60p
Input Output (Computer / Video / Control)	HDMI Display Port	x 2 (HDCP2.2)
	Trigger	x 2 (Mini jack, DC 12 V, Max. 100 mA)
	RS-232C	x 1 (D-sub 9-pin (male))
	LAN	x 1 (RJ-45, 10BASE-T/100BASE-TX)
	IR IN / OUT	IN: x1 (Mini jack)
	3D SYNC OUT	-
	USB	x 1 (Type A, DC 5 V, Max. 500 mA)
	Picture processor	X 1 for projector
Object-based HDR remaster		-
Dynamic HDR Enhancer		Yes
Object-based Super Resolution		-
Super Resolution		Yes
Dual database processing		-
Digital Contrast Optimizer		-
Digital Focus Optimizer		Yes
Dynamic contrast control		Advanced Iris
Motionflow		Yes
HDR Format		HDR10/HLG
3D		Yes
Picture position memory		5
Input lag reduction		Yes (4K/2K)
Acoustic noise		26 dB
Power requirements		AC 100-240 V, 50/60 Hz
	Power consumption	460 W
Standby		0.4 W (when "Remote Start" is set to "Off")
	Networked Standby	1.0 W (LAN) (when "Remote Start" is set to "On")
Dimensions (Without Protrusions)		W 496 x H 205 x D 464 mm (W 19 1/2 x H 8 3/32 x D 18 1/4 in)
Mass		Approx. 14 kg / 31 lb
Supplied accessories		RM-PJ24 Remote Commander (1), Size AA (R6) Manganese Batteries (2), AC Power Cord (1), Lens Cap (1), Operating Instructions (CD-ROM) (1), Quick Reference Manual (1), Safety Regulations (1)
Optional accessories		LMP-H280 (Lamp)

Dimensions

CONNECTOR PANELS



Front

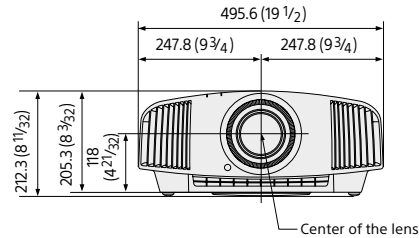

Bottom

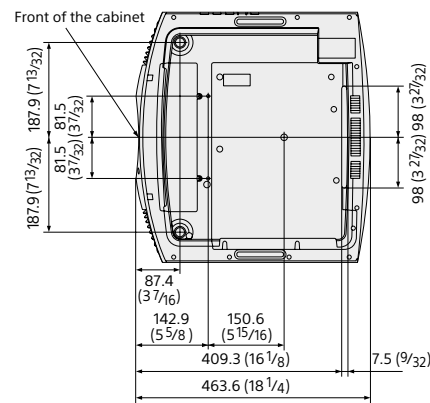

Optional Accessories



X105-RF-X1 XpanD 3D Glasses



LMP-H280 for VPL-VW590ES Projector Lamp (for replacement)

Projection distance

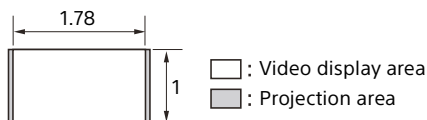

1.78:1 (16:9)		
Projection image size		Projection distance L
Diagonal	Width x Height	
80" (2.03 m)	1.77 x 1.00 (70 x 39)	2.44 - 5.01 (96 - 197)
100" (2.54 m)	2.21 x 1.25 (87 x 49)	3.05 - 6.28 (121 - 247)
120" (3.05 m)	2.66 x 1.49 (105 x 59)	3.67 - 7.55 (145 - 297)
150" (3.81 m)	3.32 x 1.87 (131 x 74)	4.60 - 9.44 (181 - 371)
200" (5.08 m)	4.43 x 2.49 (174 x 98)	6.15 - 12.61 (242 - 496)

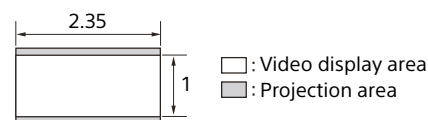

2.35:1		
Projection image size		Projection distance L
Diagonal	Width x Height	
80" (2.03 m)	1.87 x 0.80 (74 x 31)	2.41 - 4.96 (95 - 195)
100" (2.54 m)	2.34 x 0.99 (92 x 39)	3.02 - 6.22 (119 - 244)
120" (3.05 m)	2.80 x 1.19 (110 x 47)	3.64 - 7.47 (143 - 294)
150" (3.81 m)	3.51 x 1.49 (138 x 59)	4.55 - 9.35 (180 - 368)
200" (5.08 m)	4.67 x 1.99 (184 x 78)	6.08 - 12.48 (240 - 491)

© 2020 Sony Corporation.

All rights reserved. Reproduction in whole or in part without permission is prohibited. Features and specifications are subject to change without notice. All non-metric weights and measurements are approximate. 'Sony' is a registered trademark of Sony Corporation. All other trademarks are the property of their respective owners. Errors and omissions excepted.

www.pro.sony  [@SonyDisplays](https://twitter.com/SonyDisplays)

Follow us on  [LinkedIn](#).

SONY

Distributed by

