

4286PS-90cm
4286PB-90cm

MONTAGEANLEITUNG

Höhenverstellbare Halterung
mit Antikollisionsfunktion

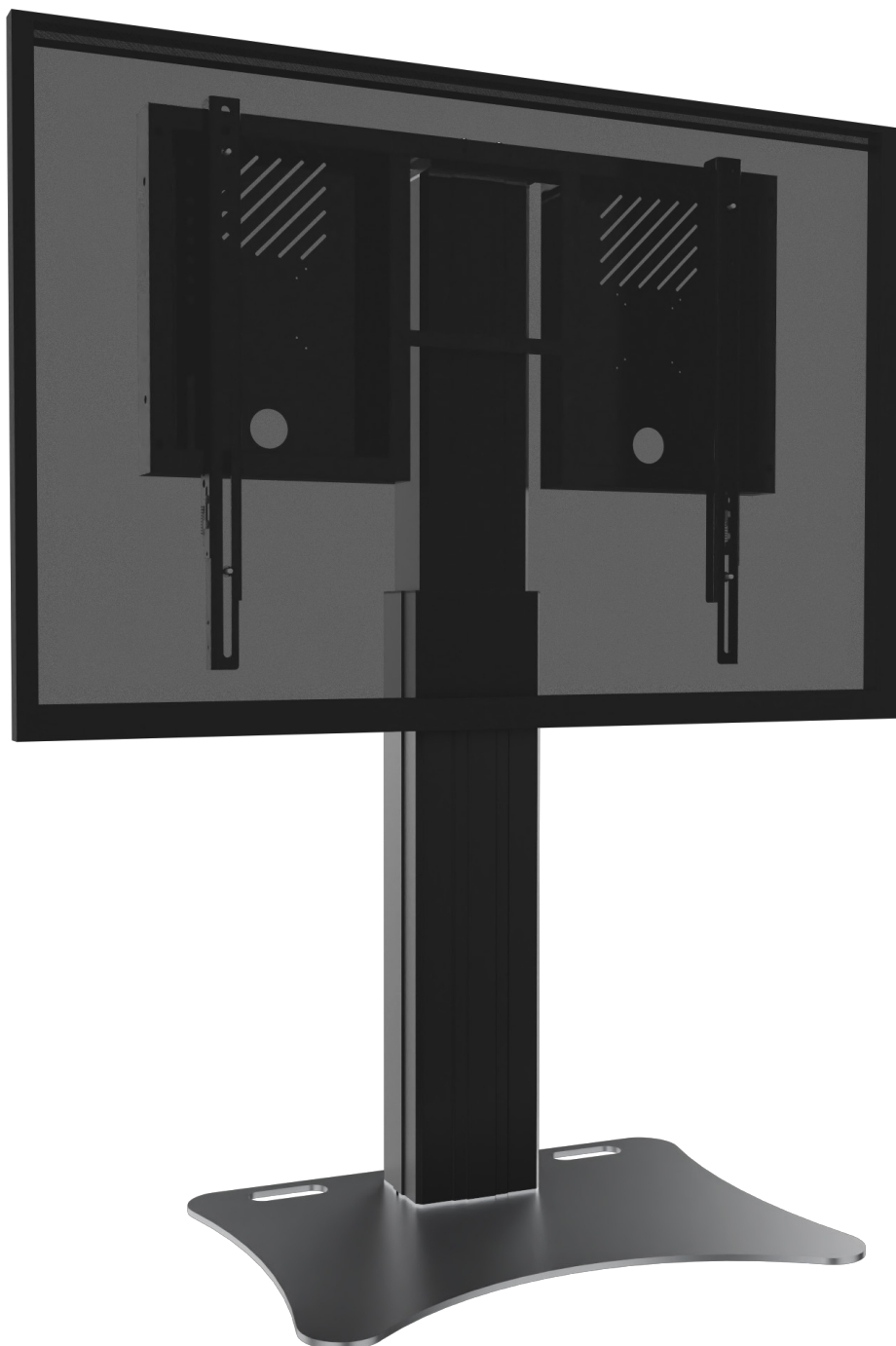

PACKUNGSIHALT

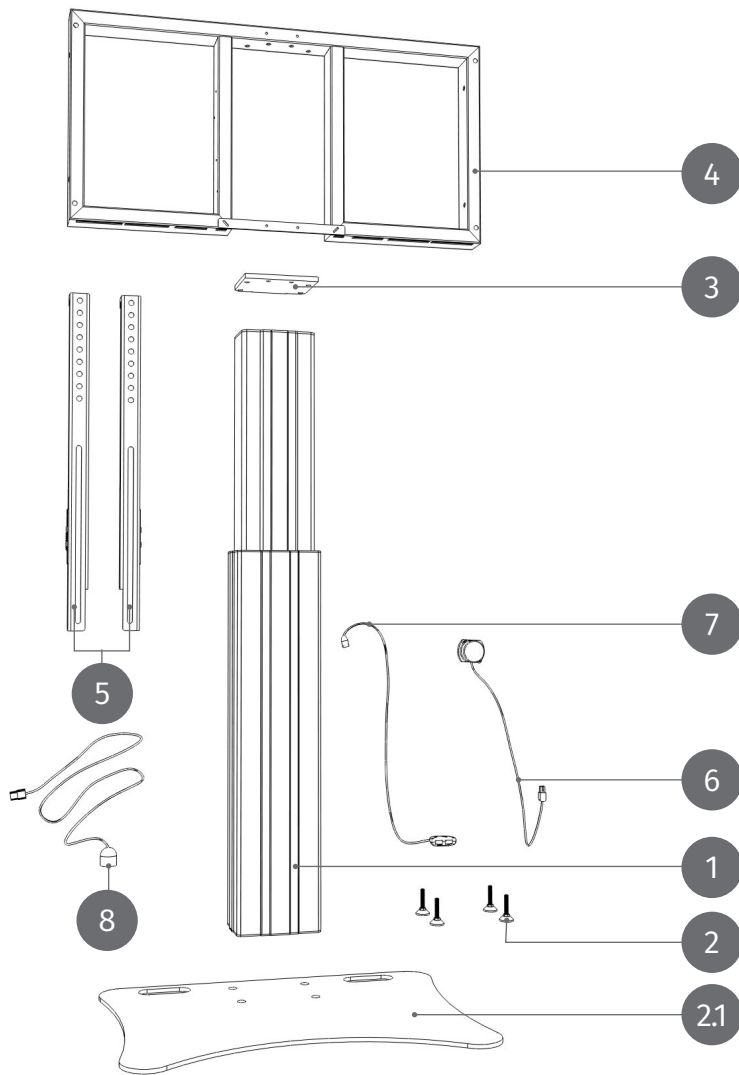

- 1 Höhenverstellbare Säule
- 2 Stellfüße
- 2.1 Bodenplatte
- 3 Adapterplatte
- 4 Rahmen
- 5 Einhängeschienen
- 6 Anti-Kollision-Einheit
- 7 Bedienteil
- 8 Stromkabel

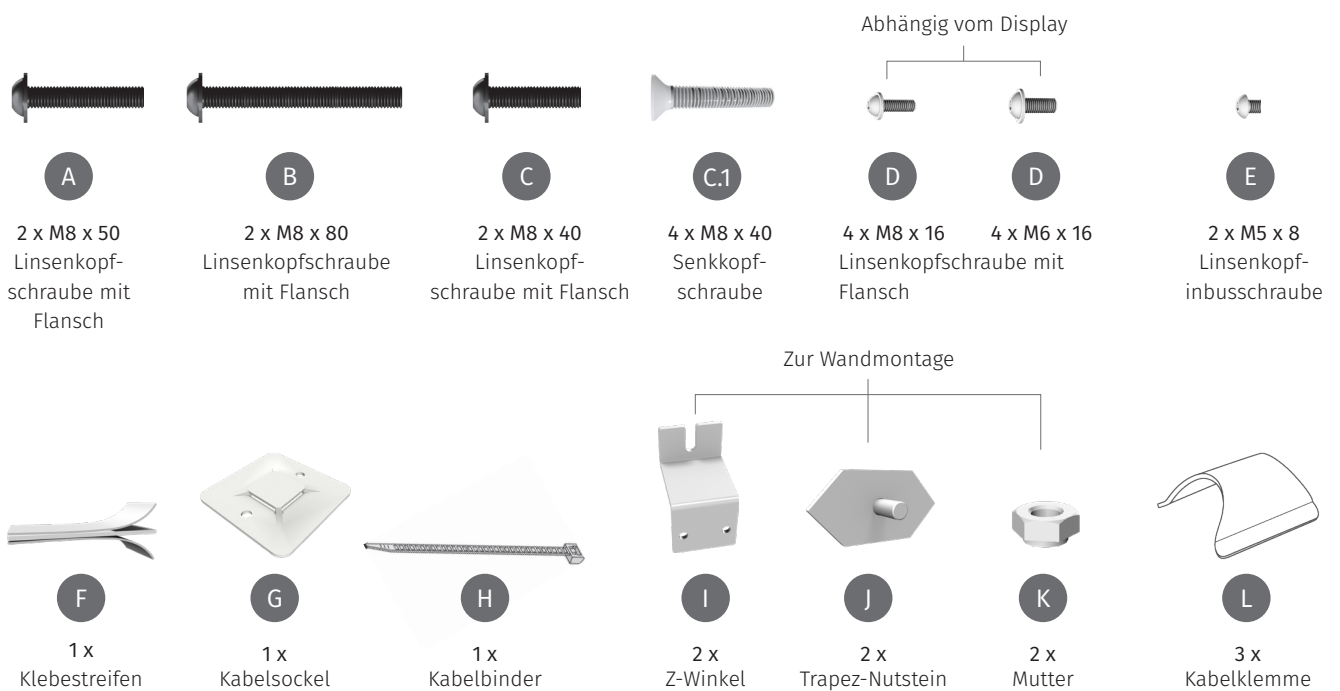

MONTAGEANLEITUNG

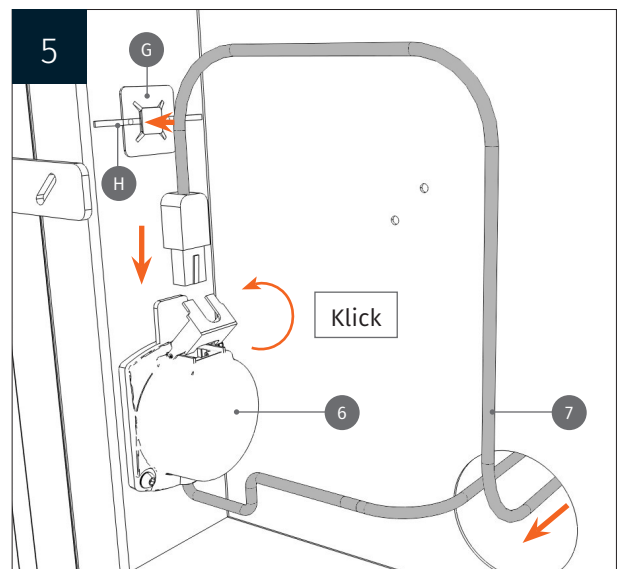
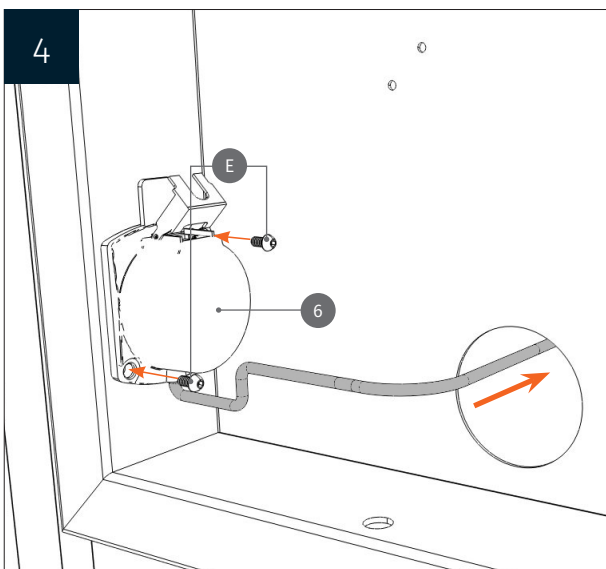
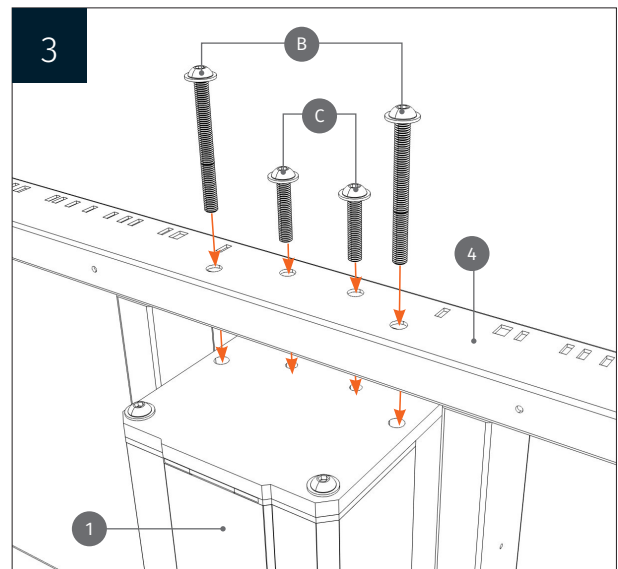
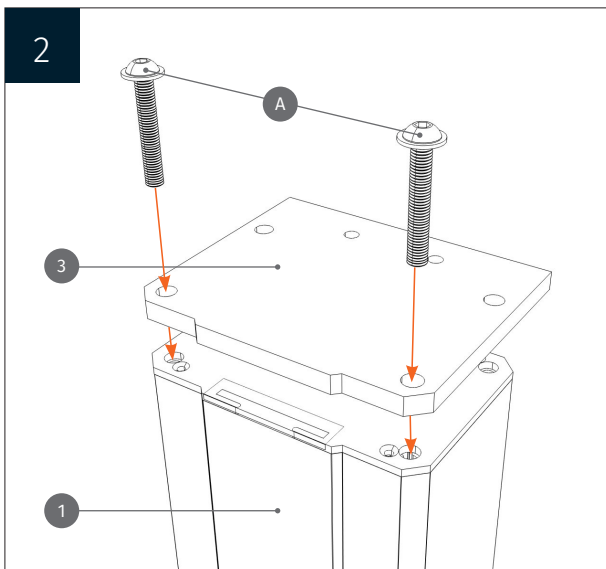
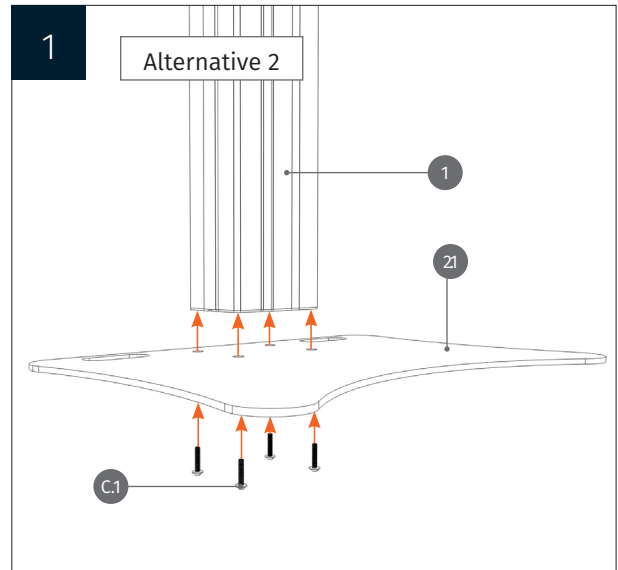
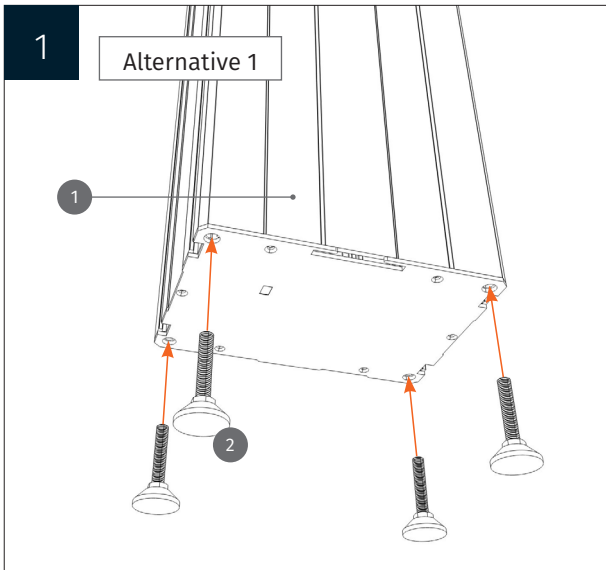

MONTAGEANLEITUNG

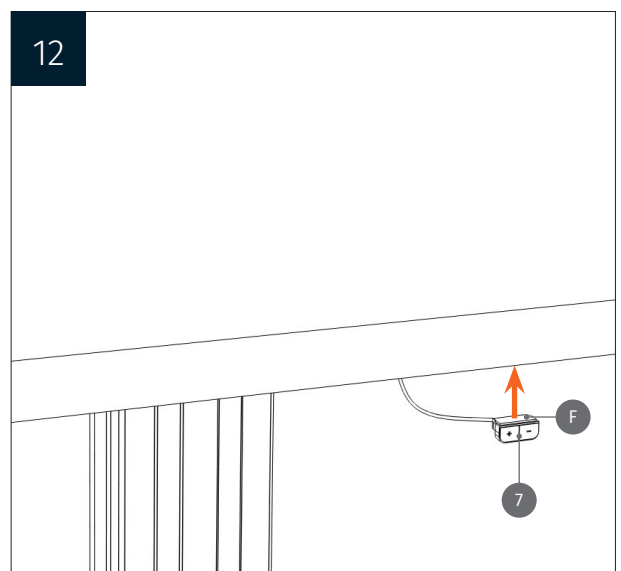
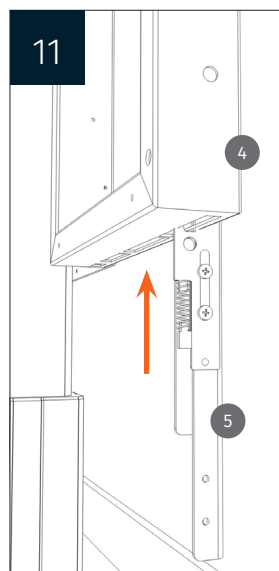
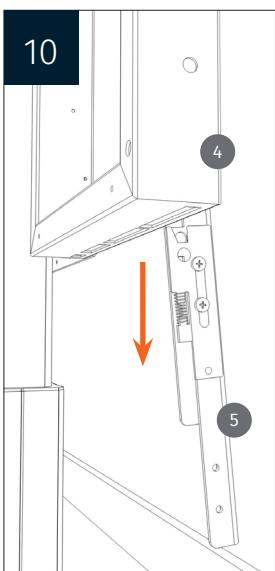
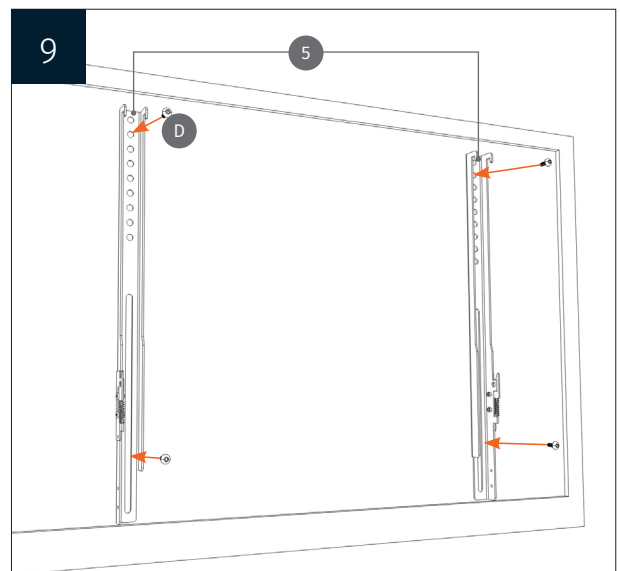
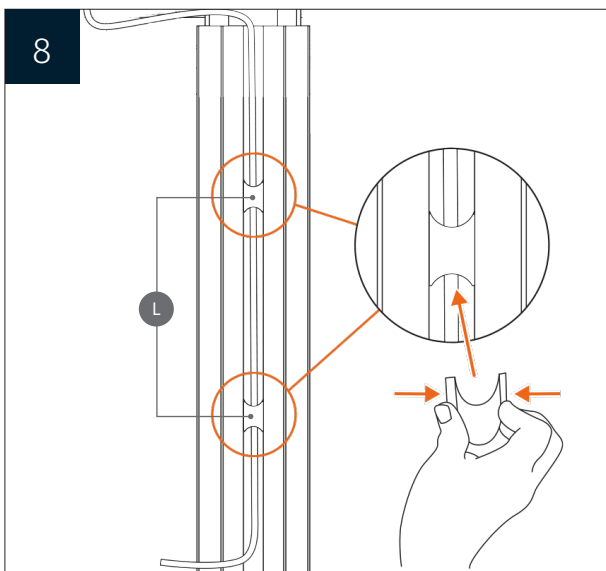
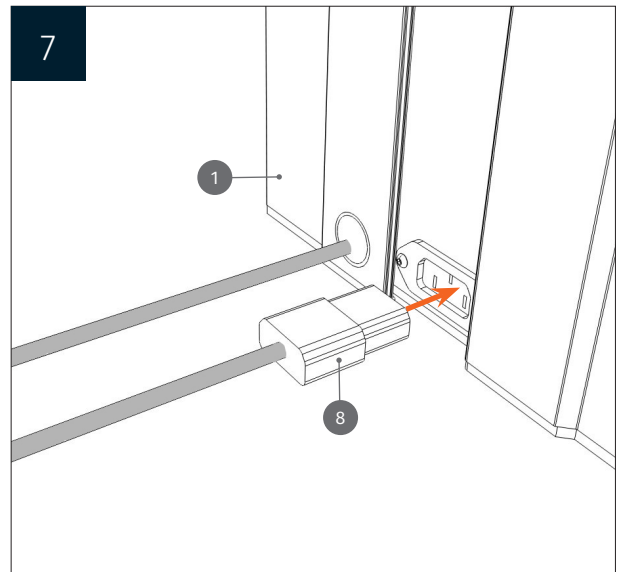
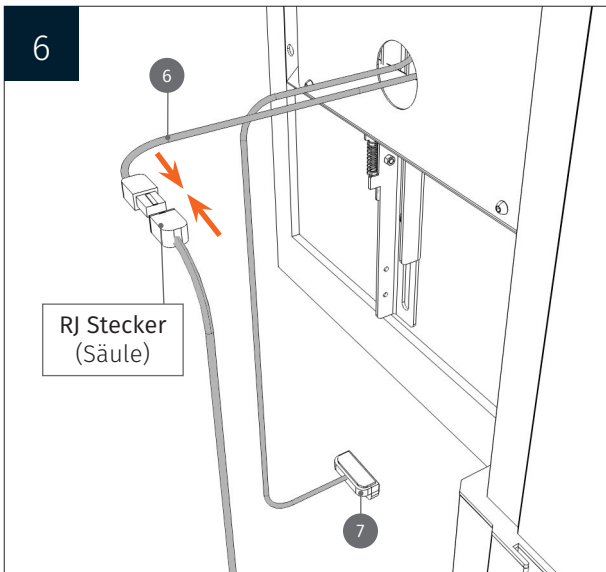

MONTAGEANLEITUNG

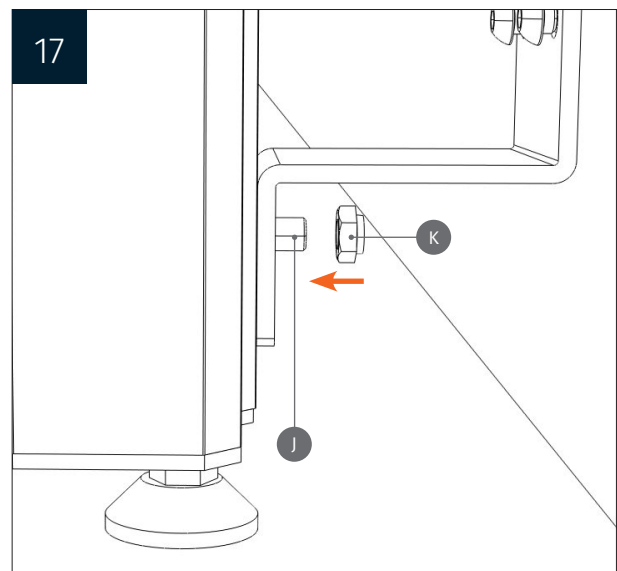
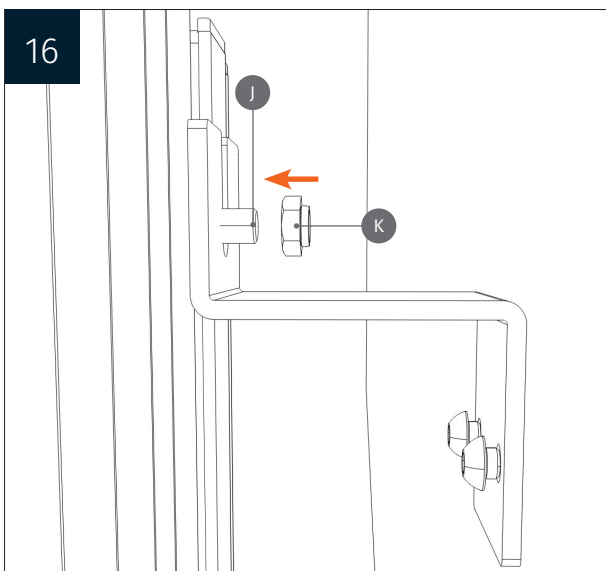
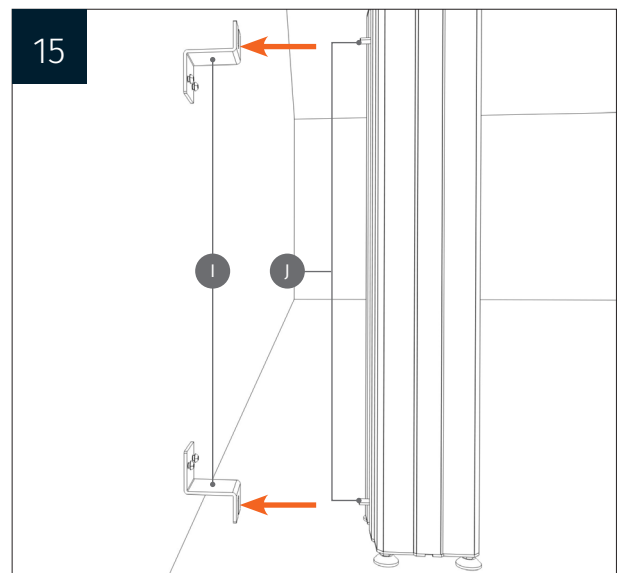
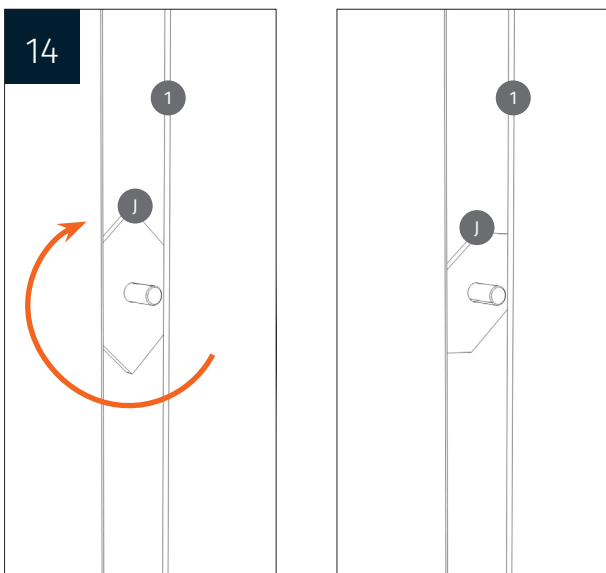
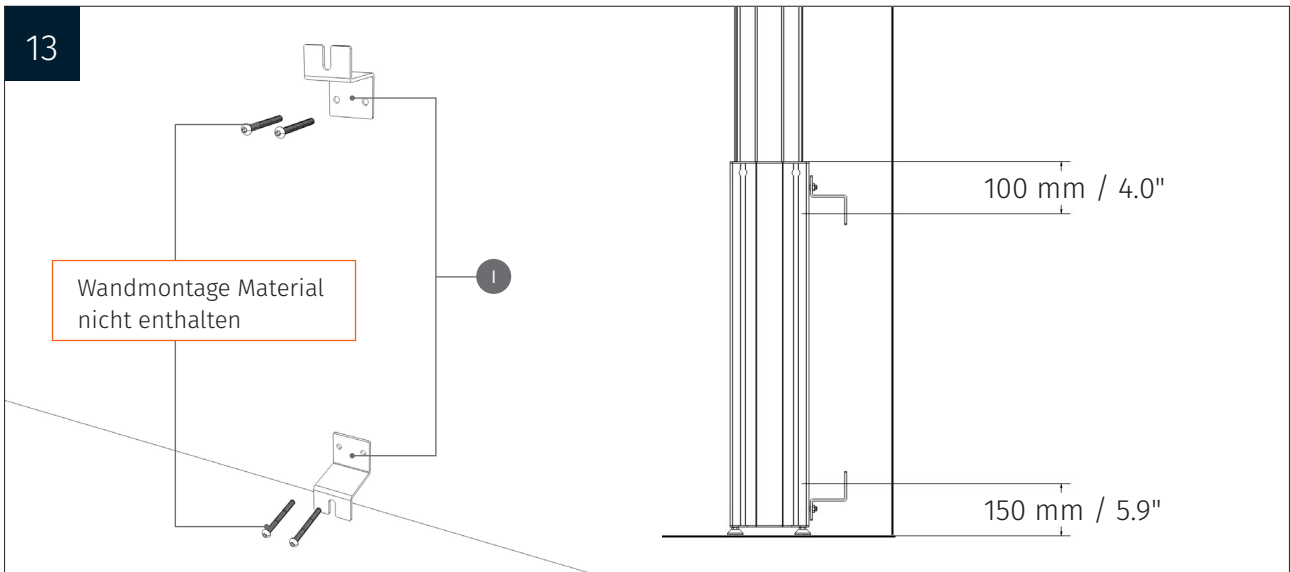

MONTAGEANLEITUNG

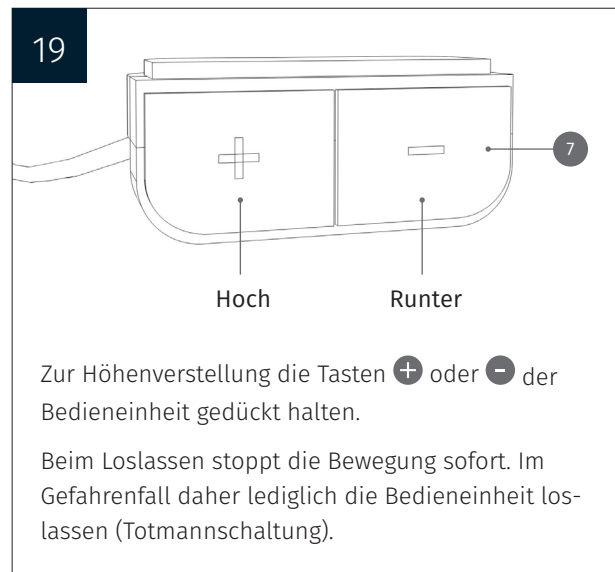
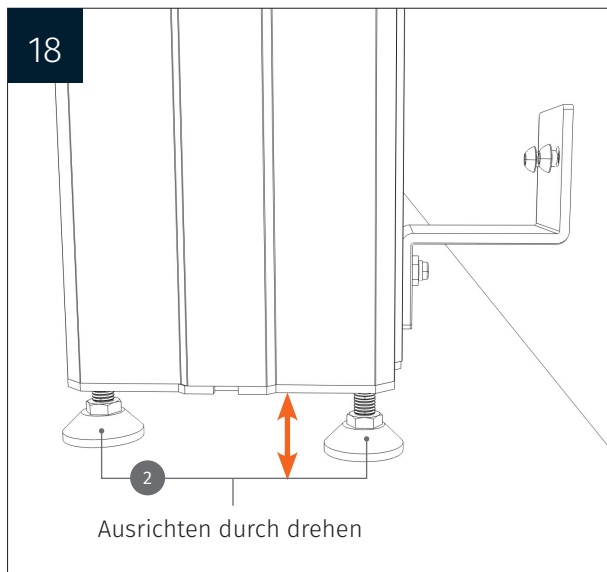

FEHLERBEHEBUNG

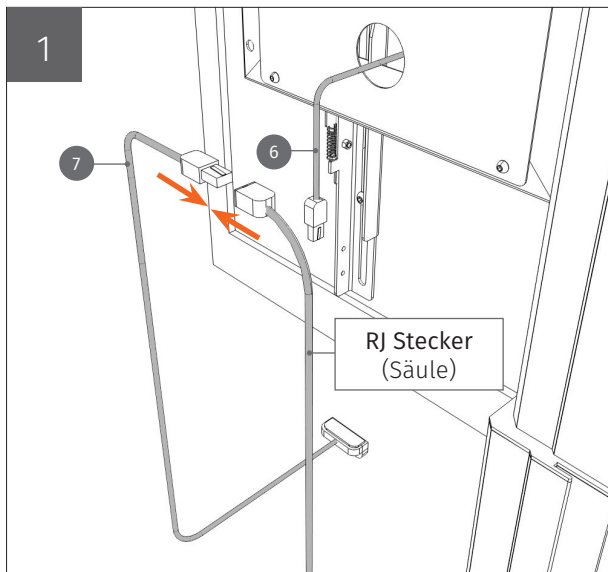

2

Alle Systeme sind vorkalibriert.
BITTE NUR BEI FEHLERMELDUNGEN NEU KALIBRIEREN.

Kalibrierung:

- 1 Drücken Sie gleichzeitig die Tasten **+** und **-** bis Sie 1 x den Signalton hören.
- 2 Drücken Sie die Taste **-** bis Sie 3 x den Signalton hören.
- 3 Drücken Sie die Taste **+** bis die Säule in die oberste Position gefahren ist und der Signalton 2 x zu hören ist.

3

Anschließend bei Punkt **9** der Montageanleitung weitermachen.

Bohrung zur Befestigung eines Videokonferenz Tablet

Bohrungen zur Befestigung unserer Tastaturablage

Bohrungen zur Befestigung einer Steckdosenableiste

Bohrung für den Mini-PC
VESA 100 x 100 + 75 x 75

Bohrungen zur Befestigung von Whiteboard-
flügeln oder Griffen

