

### TECHNICAL DATA\*

Power supply:	230 V 50 HZ
Max power consumption:	156 W
Motor speed:	17 Rpm
Motor performance:	10 Nm
Dimensions „lift closed“:	575 x 240 x 554 mm (WxHxD)
Dimensions „lift open“ :	575 x 1964 x 554 mm (WxHxD)
Total dimension grille:	410 x 450 mm (WxD)
Internal dimension grille (projector):	320 x 350 mm (WxD)
Max. load:	15 KG
Net weight of lift:	15 KG
Kabel Management System:	20 x 18 mm (WxH)

### FRONTAL VIEW "LIFT CLOSED"\*

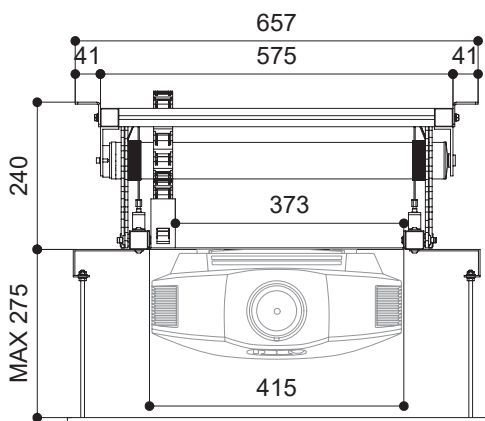

### SIDE VIEW "LIFT CLOSED"\*

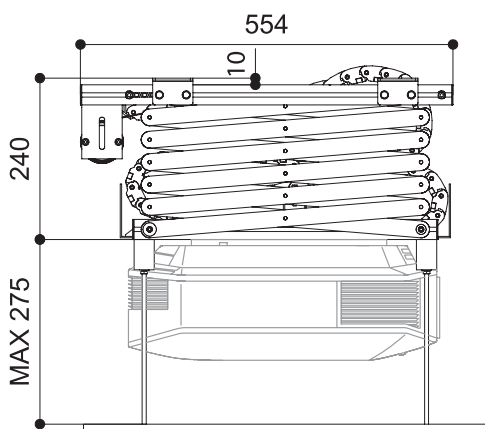

### SIDE VIEW "LIFT OPEN"\*

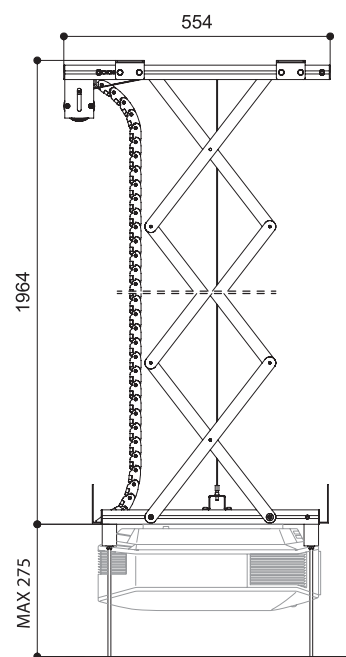

\* All dimensions provided are in mm. We do not take responsibility for any mistakes or printing errors. Due to continuous technical improvements, we reserve the right to change design and specifications without prior notice.