

Projector

PA1705UL-W/PA1705UL-B
PA1505UL-W/PA1505UL-B

User's Manual

Model No.

NP-PA1705UL-W/NP-PA1705UL-B/NP-PA1505UL-W/NP-PA1505UL-B

Table of Contents

Introduction	ii
Important Information	iii
1. Check the product overview, supplied items and part names	1
1-1. Introduction to the Projector	1
1-2. What's in the Box?	4
1-3. Part Names of the Projector	5
1-4. Part Names of the Remote Control	11
2. Projecting an Image (Basic Operation)	18
2-1. Flow of Projecting an Image	18
2-2. Connecting Your Computer/Connecting the Power Cord	19
2-3. Turning on the Projector	22
2-4. Selecting a Source	25
2-5. Adjusting the Picture Size and Position	27
2-6. Adjusting a picture and sound	34
2-7. Turning off the Projector	35
2-8. After Use	36
3. Appendix	37
3-1. Specifications	37
3-2. Troubleshooting	40
3-3. Mounting a lens (sold separately)	46
REGISTER YOUR PROJECTOR! (for residents in the United States, Canada, and Mexico)	Back cover

Introduction

Thank you for purchasing the NEC projector.

This projector can be connected to computers, video devices, etc. to project images sharply onto a screen.

Please read this manual carefully before using your projector.

Read this manual if you have any doubts about operation or if you believe the projector may be faulty.

The Installation Manual provides detailed instructions on installation, adjustments, maintenance, etc., is posted on our website.

https://www.sharp-nec-displays.com/dl/en/pj_manual/lineup.html

NOTES



- (1) The contents of this manual may not be reprinted in part or whole without permission.
- (2) The contents of this manual are subject to change without notice.
- (3) Great care has been taken in the preparation of this manual; however, should you notice any questionable points, errors or omissions, please contact us.
- (4) The image shown in this manual is indicative only. If there is inconsistency between the image and the actual product, the actual product shall govern.
- (5) Notwithstanding article (3) and (4), we will not be responsible for any claims on loss of profit or other matters deemed to result from using this device.
- (6) This manual is commonly provided to all regions so they may contain descriptions that are pertinent for other countries.

Important Information









About the symbols

To ensure safe and proper use of the product, this manual uses a number of symbols to prevent injury to you and others as well as damage to property.

The symbols and their meanings are described below. Be sure to understand them thoroughly before reading this manual.

 WARNING	Failing to heed this symbol and handling the product erroneously could result in accidents leading to death or major injury.
 CAUTION	Failing to heed this symbol and handling the product erroneously could result in personal injury or damage to surrounding property.

Examples of symbols

	This symbol indicates you should be careful of electric shocks.
	This symbol indicates you should be careful of high temperatures.
	This symbol indicates something that must be prohibited.
	This symbol indicates something that must not be got wet.
	This symbol indicates you should not touch with wet hands.
	This symbol indicates something that must not be disassembled.
	This symbol indicates things you must do.
	This symbol indicates that the power cord should be unplugged from the power outlet.

Safety Cautions

WARNING

Projected light



PROHIBITED

Projected light and the pictogram/label indicated on the cabinet

- Do not look into the projector's lens.
Strong light that could damage your vision is projected when the projector is operating. Laser energy exposure near aperture may cause burns. Be especially careful when children are around.
- Do not look at the projected light using optical devices (magnifying glasses, reflectors, etc.). Doing so could result in vision impairment.
- Check that there is no one looking at the lens within the projection range before turning on the projector.
- Do not allow children to operate the projector alone. When a child is operating the projector an adult should always be present and watch the child carefully.
- The below pictogram, that is indicated near the lens on the cabinet, describes looking into the projector is prohibited.

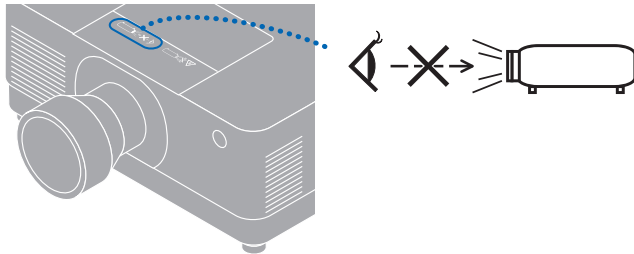

Continue to next page

WARNING

• The following labels are stuck on the projector.

Label 1
Laser explanatory label



This product complies with EN 50689:2021 except using the lens of NP55ZL and NP56ZL.

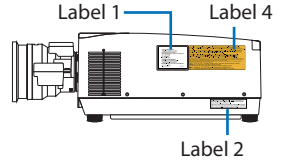

Label 2
FDA certification label

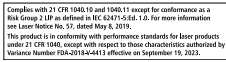

Label 3
FDA additional warning label

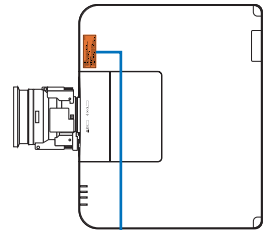
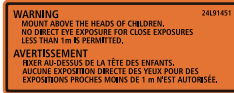

Label 4
Lens replacement caution label
PA1705UL-W/PA1705UL-B

CAUTION < DO NOT STARE INTO THE BEAM - RG2 > THIS PROJECTOR MAY BECOME RG3 WHEN AN INTERCHANGEABLE LENS WITH THRU RATIO GREATER THAN 2.6 IS INSTALLED. REFER TO THE MANUAL FOR THE LENS LIST AND HAZARD DISTANCE BEFORE OPERATION. SUCH COMBINATIONS OF PROJECTOR AND LENS ARE INTENDED FOR PROFESSIONAL USE ONLY AND ARE NOT INTENDED FOR CONSUMER USE.

ATTENTION < NE PAS REGARDER DANS LE FAISCEAU - RG2 > CE PROJECTEUR PEUT DEVENIR RG3 LORSQU'UN OBJECTIF INTERCHANGEABLE AVEC UN RAPPORT DE PROJECTION SUPÉRIEUR À 2,6 EST INSTALLÉ. AVANT UTILISATION, REPORTEZ-VOUS AU MANUEL POUR TROUVER LA LISTE DES OBJECTIFS ET LA DISTANCE DE DANGER. CES COMBINATIONS DE PROJECTEUR ET D'OBJECTIF SONT DESTINÉES À UN USAGE PROFESSIONNEL UNIQUEMENT ET NE SONT PAS DESTINÉES À UNE UTILISATION GRAND PUBLIC.

VORSICHT < NICHT DIREKT IN DEN STRAHL BLICKEN - RG2 > DIESER PROJECTOR KANN IN DIE GRUPPE RG3 FALLEN, WENN EIN AUSTAUSCHBARES OBJEKTIV MIT EINEM BILDABSTANDSVERHÄLTNIS VON MEHR ALS 2,6 INSTALLIERT WIRD. BEACHTEN SIE VON DEM BETRIEB DAS HANDBUCH FÜR EINE LISTE DER OBJEKTIVE UND ZU DEN GEFÄHRDUNGSRICHEN. SOLICHE KOMBINATIONEN AUS PROJECTOR UND OBJEKTIV SIND NUR FÜR DEN PROFESSIONELLEN EINSATZ UND NICHT FÜR ALLGEMEINE VERBRAUCHER BESTIMMT.

ВНИМАНИЕ < НЕ СМОТРИТЕ НА ЛУЧ - RG2 > ЭТОТ ПРОЕКТОР МОЖЕТ СТАТЬ RG3, ЕСЛИ УСТАНОВЛЕН СМЕННОЙ ОБЪЕКТИВ С КОЭФФИЦИЕНТОМ УВЕЛИЧЕНИЯ БОЛЬШЕ 2,6. ПЕРЕД НАЧАЛОМ РАБОТЫ ОБРАТИТЕСЬ К РУКОВОДСТВУ ПОЛЬЗОВАТЕЛЯ ДЛЯ ОЗНАКОМЛЕНИЯ СО СПИСКОМ ОБЪЕКТИВОВ И ЗНАЧЕНИЕМ БЕЗОПАСНОГО РАСТЯТОИЯ. ДАННЫЕ КОМБИНАЦИИ ПРОЕКТОРА И ОБЪЕКТИВА ПРЕДНАЗНАЧЕНЫ ТОЛЬКО ДЛЯ ПРОФЕССИОНАЛЬНОГО ИСПОЛЬЗОВАНИЯ И НЕ ПРЕДНАЗНАЧЕНЫ ДЛЯ ИСПОЛЬЗОВАНИЯ ПОТРЕБИТЕЛЕМ.

주의 < 빔 응시 금지 - RG2 > 이 프로젝트는 투사율이 2.6보다 큰 교환식 렌즈가 설치된 경우 RG3이 될 수 있습니다. 사용 전 렌즈 목록 및 위험 거리에 대해서는 설명서를 참조하십시오. 프로젝트와 렌즈의 이러한 조합은 전문가용으로만 사용해야 하며 소비자용으로 사용해서는 안 됩니다.

警告 < 請勿直視光束 - RG2 > 在安裝了投射比大於 2.6 的互換式鏡頭時，本投影機可能變為 RG3。在操作前請參閱手冊瞭解鏡頭列表和危險距離。此投影機和鏡頭的組合僅供專業用途，不供客戶使用。

PA1505UL-W/PA1505UL-B

CAUTION < DO NOT STARE INTO THE BEAM - RG2 > THIS PROJECTOR MAY BECOME RG3 WHEN AN INTERCHANGEABLE LENS WITH THRU RATIO GREATER THAN 2.9 IS INSTALLED. REFER TO THE MANUAL FOR THE LENS LIST AND HAZARD DISTANCE BEFORE OPERATION. SUCH COMBINATIONS OF PROJECTOR AND LENS ARE INTENDED FOR PROFESSIONAL USE ONLY AND ARE NOT INTENDED FOR CONSUMER USE.

ATTENTION < NE PAS REGARDER DANS LE FAISCEAU - RG2 > CE PROJECTEUR PEUT DEVENIR RG3 LORSQU'UN OBJECTIF INTERCHANGEABLE AVEC UN RAPPORT DE PROJECTION SUPÉRIEUR À 2,9 EST INSTALLÉ. AVANT UTILISATION, REPORTEZ-VOUS AU MANUEL POUR TROUVER LA LISTE DES OBJECTIFS ET LA DISTANCE DE DANGER. CES COMBINATIONS DE PROJECTEUR ET D'OBJECTIF SONT DESTINÉES À UN USAGE PROFESSIONNEL UNIQUEMENT ET NE SONT PAS DESTINÉES À UNE UTILISATION GRAND PUBLIC.

VORSICHT < NICHT DIREKT IN DEN STRAHL BLICKEN - RG2 > DIESER PROJECTOR KANN IN DIE GRUPPE RG3 FALLEN, WENN EIN AUSTAUSCHBARES OBJEKTIV MIT EINEM BILDABSTANDSVERHÄLTNIS VON MEHR ALS 2,9 INSTALLIERT WIRD. BEACHTEN SIE VON DEM BETRIEB DAS HANDBUCH FÜR EINE LISTE DER OBJEKTIVE UND ZU DEN GEFÄHRDUNGSRICHEN. SOLICHE KOMBINATIONEN AUS PROJECTOR UND OBJEKTIV SIND NUR FÜR DEN PROFESSIONELLEN EINSATZ UND NICHT FÜR ALLGEMEINE VERBRAUCHER BESTIMMT.

ВНИМАНИЕ < НЕ СМОТРИТЕ НА ЛУЧ - RG2 > ЭТОТ ПРОЕКТОР МОЖЕТ СТАТЬ RG3, ЕСЛИ УСТАНОВЛЕН СМЕННОЙ ОБЪЕКТИВ С КОЭФФИЦИЕНТОМ УВЕЛИЧЕНИЯ БОЛЬШЕ 2,9. ПЕРЕД НАЧАЛОМ РАБОТЫ ОБРАТИТЕСЬ К РУКОВОДСТВУ ПОЛЬЗОВАТЕЛЯ ДЛЯ ОЗНАКОМЛЕНИЯ СО СПИСКОМ ОБЪЕКТИВОВ И ЗНАЧЕНИЕМ БЕЗОПАСНОГО РАСТЯТОИЯ. ДАННЫЕ КОМБИНАЦИИ ПРОЕКТОРА И ОБЪЕКТИВА ПРЕДНАЗНАЧЕНЫ ТОЛЬКО ДЛЯ ПРОФЕССИОНАЛЬНОГО ИСПОЛЬЗОВАНИЯ И НЕ ПРЕДНАЗНАЧЕНЫ ДЛЯ ИСПОЛЬЗОВАНИЯ ПОТРЕБИТЕЛЕМ.

주의 < 빔 응시 금지 - RG2 > 이 프로젝트는 투사율이 2.9보다 큰 교환식 렌즈가 설치된 경우 RG3이 될 수 있습니다. 사용 전 렌즈 목록 및 위험 거리에 대해서는 설명서를 참조하십시오. 프로젝트와 렌즈의 이러한 조합은 전문가용으로만 사용해야 하며 소비자용으로 사용해서는 안 됩니다.

警告 < 請勿直視光束 - RG2 > 在安裝了投射比大於 2.9 的互換式鏡頭時，本投影機可能變為 RG3。在操作前請參閱手冊瞭解鏡頭列表和危險距離。此投影機和鏡頭的組合僅供專業用途，不供客戶使用。

 **WARNING**

- This projector is classified as either IEC/EN 62471-5:2015 risk group 2 or risk group 3 depending on the lens unit. When classified as risk group 3, this projector is intended for professional use and must be installed by professional installer to ensure safety. See page [xv](#) for risk groups.
- See page [xiv](#) for Laser Safety Caution.

Power supply



REQUIRED

Use a suitable voltage power supply.

- This projector is designed to be used with a 100–240 V AC, 50/60 Hz power supply. Before using the projector, check that the power supply to which the projector is to be connected meets these requirements.
- Use a power outlet as the projector's power supply. Do not connect the projector directly to electrical light wiring. Doing so is dangerous.



REQUIRED

Connecting the power cord to earth

- This equipment is designed to be used in the condition of the power cord connected to earth. If the power cord is not connected to the earth, it may cause electric shock. Please make sure the power cord is connected to the wall outlet directly and earthed properly. Do not use a 2-pin plug converter adapter.
- Be sure to connect the projector and the computer (signal source) to the same earth point. If the projector and the computer (signal source) will be connected to different earth points, fluctuations in the earth potential may cause fire or smoke.



REQUIRED

Handling the power cord

- Please use the power cord supplied with this projector. If the supplied power cord does not satisfy requirements of your country's safety standard, and voltage and current for your region, make sure to use the power cord that conforms to and satisfies them.

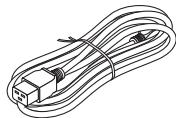

- The power cord you use must be approved by and comply with the safety standards of your country. Please refer to the page [38](#) about the power cord specification. For selecting an appropriate power cord, please check rated voltage for your region by yourself.



PROHIBITED

- The power cord included with this projector is exclusively for use with this projector. For safety, do not use it with other devices.

Continue to next page

 **WARNING**



**HAZARDOUS
VOLTAGE**

- Handle the power cord with care. Damaging the cord could lead to fire or electric shock.
 - Do not place heavy objects on the cord.
 - Do not place the cord under the projector.
 - Do not cover the cord with a rug, etc.
 - Do not scratch or modify the cord.
 - Do not bend, twist or pull the cord with excessive force.
 - Do not apply heat to the cord.
- Should the cord be damaged (exposed core wires, broken wires, etc.), ask your dealer to replace it.
- Do not touch the power plug should you hear thunder. Doing so could result in electric shock.
- Do not connect or disconnect the power cord with wet hands. Doing so could result in electric shock.



**DO NOT TOUCH
WITH WET
HANDS**

Installation



PROHIBITED

Do not use in places such as those described below.







- Do not use in places such as those described below. Doing so could lead to fire or electric shock.
 - Shaky tables, inclined surfaces or other unstable places
 - Near heating appliances or places with heavy vibrations
 - Outdoors or humid or dusty places
 - Places exposed to oil smoke or steam
 - Near cooking appliances, humidifiers, etc.
 - Do not use in places such as those described below where the projector could get wet. Doing so could lead to fire or electric shock.
 - Do not use in the rain or snow, on a seashore or waterfront, etc.
 - Do not use in a bathroom or shower room.
 - Do not install under equipment that discharges water, such as air conditioners.
 - Do not place vases or potted plants on the projector.
 - Do not place cups, cosmetics or medicines on the projector.
- Should water, etc. get inside the projector, first turn off the projector's power, then unplug the power cord from the power outlet and contact your dealer.









DO NOT WET









**UNPLUG THE
POWER CORD**

 WARNING	
 CAUTION	<p>Installing suspended from the ceiling</p> <ul style="list-style-type: none"> • Consult your dealer for installing the projector on the ceiling. Special skills are required for ceiling installation. DO NOT perform installation work by people other than installers. Doing so may result in the projector falling and causing injury. • We are not liable for any accident or/and damage resulting from improper installation or handling, misuse, modification, or natural disasters. • When installed suspended from the ceiling, etc. do not hang from the projector. The projector could drop and cause injury. • When installing suspended from the ceiling, use a power outlet that is within reach so the power cord can be easily plugged and unplugged.
 REQUIRED  PROHIBITED	<p>Attach the separately sold option cover for tilted installation</p> <ul style="list-style-type: none"> • For tilted installation of the projector, depending on the angle, be sure to attach the separately sold option cover for safety. (→ page xxvi) Using without the option cover violates safety regulations. Also, powering the projector on without the option cover installed could result in a fire. • Do not put bundled cables in the option cover. Doing so may damage the power cord, resulting in a fire.
On use	
 PROHIBITED  UNPLUG THE POWER CORD	<p>Do not place objects inside the projector.</p> <ul style="list-style-type: none"> • Do not insert or drop metal or combustible objects or other foreign materials into the projector from the vents. Doing so could lead to fire or electric shock. Be particularly careful if there are children in the home. Should a foreign object get inside the projector, first turn off the projector's power, then unplug the power cord from the power outlet and contact your dealer.
 UNPLUG THE POWER CORD	<p>Unplug the power cord if the projector malfunctions.</p> <ul style="list-style-type: none"> • Should the projector emit smoke or strange odors or sounds, or if the projector has been dropped or the cabinet broken, turn off the projector's power, then unplug the power cord from the power outlet. It may cause not only fire or electric shock but also serious damage to your eyesight or burns. Contact your dealer for repairs. Never try to repair the projector on your own. Doing so is dangerous.

 WARNING	
 DO NOT DISASSEMBLE	<p>Do not disassemble the projector.</p> <ul style="list-style-type: none"> Do not remove or open the projector's cabinet. Also, do not modify the projector. There are high voltage areas in the projector. It may cause fire, electric shock, or laser light leakage, resulting in serious damage to your eyesight or burns. Have qualified service personnel perform inspection, adjustments and repairs of the interior.
 PROHIBITED  CAUTION FOR HIGH TEMPERATURE	<p>Do not place objects in front of the lens while the projector is operating.</p> <ul style="list-style-type: none"> Do not leave the lens cap on the lens while the projector is operating. The lens cap could get hot and be warped. Do not place objects in front of the lens that obstruct the light while the projector is operating. The object could get hot and be broken or catch fire. The below pictogram indicated on the cabinet means the precaution for avoiding to place objects in front of the projector lens. <div style="text-align: center;">  </div>
 PROHIBITED	<p>When cleaning the projector</p> <ul style="list-style-type: none"> Do not use flammable gas sprays to remove dust from the lens, cabinet, etc. Doing so could lead to fire.
 PROHIBITED	<p>Do not use in high security locations.</p> <ul style="list-style-type: none"> Usage of the product must not be accompanied by fatal risks or dangers that, could lead directly to death, personal injury, severe physical damage or other loss, including nuclear reaction control in nuclear facility, medical life support system, and missile launch control in a weapon system.

 **CAUTION**

Power cord	
 REQUIRED	<p>Handling the power cord</p> <ul style="list-style-type: none"> • The projector should be installed close to an easily accessible power outlet. • When connecting the power cord to the projector's AC IN terminal, make sure the connector is fully and firmly inserted. Be sure to fix the power cord using the power cord stopper. Loose connection of the power cord could lead to fire or electric shock.
 REQUIRED  UNPLUG THE POWER CORD	<p>Handling the power cord by following below to avoid fire or electric shock</p> <ul style="list-style-type: none"> • When connecting or disconnecting the power cord, pull the power cord out by holding onto its plug. • Unplug the power cord from the power outlet before cleaning the product or when not planning to use the product for an extended time. • When the power cord or plug is heat or damaged, unplug the power cord from the power outlet, and contact your dealer.
 REQUIRED	<p>Periodically clean dust and other debris from the power plug</p> <ul style="list-style-type: none"> • Failure to do so could result in fire or electric shock.
 REQUIRED	<p>Disconnect power cords and other cables before moving the projector</p> <ul style="list-style-type: none"> • Before moving the product, make sure the product power is off, then unplug the power cord from the power outlet and check that all cables connecting the product to other devices are disconnected.
 PROHIBITED	<p>Do not use the power cord with a power tap</p> <ul style="list-style-type: none"> • Adding an extension cord may lead to fire as a result of overheating.

**CAUTION****Installation****REQUIRED****Securing the lens unit with the fall prevention wire**

- If the projector is going to be suspended from a ceiling or another high place, secure the lens unit using the fall prevention wire (sold separately). If the lens unit is not secured, it may fall down if it comes loose.

On use**PROHIBITED****Do not use on networks subject to overvoltage.**

- Connect the projector's HDBaseT port and LAN port to a network for which there is no risk of overvoltage being applied. Overvoltage applied to the HDBaseT or LAN port could result in electric shock.

**REQUIRED****Lens shift, focus and zoom operations**

- When shifting the lens or adjusting the focus or zoom, do so from either behind or the side of the projector. If adjustments are performed from the front, your eyes could be exposed to strong light and get injured.
- Keep your hands away from the lens area when performing the lens shift operation. If not, your fingers could get caught in the gap between the cabinet and the lens.

 **CAUTION**



PROHIBITED

Handling batteries

Incorrect usage of batteries can result in leaks or bursting.

- Use the specified batteries only.
- Insert batteries matching the (+) and (-) signs on each battery to the (+) and (-) signs of the battery compartment.
- Do not mix battery brands.
- Do not combine new and old batteries. This can shorten battery life or cause liquid leakage of batteries.
- Remove dead batteries immediately to prevent battery acid from leaking into the battery compartment.

If leaked battery fluid gets on your skin or clothing, rinse immediately and thoroughly. If it gets into your eye, bathe your eye well rather than rubbing and seek medical treatment immediately. Leaked battery fluid that gets into your eye or your clothing may cause a skin irritation or damage your eye.

- If you will not use the remote control for a long time, remove the batteries.
- Leaving a battery in an extremely high temperature surrounding environment, or a battery subject to extremely low air pressure, that can result in an explosion or the leakage of flammable liquid or gas.
- Properly dispose of depleted batteries. Disposal of a battery into water, fire, or a hot oven, or mechanically crushing, cutting, or modifying a battery can result in an explosion.
- Do not short-circuit the batteries.
- Do not charge the batteries. The batteries provided are not rechargeable.
- Contact your dealer or local authorities when disposing of batteries.



PROHIBITED









**CAUTION
FOR HIGH
TEMPERATURE**

About the vents

- Do not obstruct the projector's vents. Also, do not place such soft objects as paper or cloths underneath the projector. Doing so could lead to fire. Leave sufficient space between the place where the projector is installed and its surroundings. (→ page xxix)
- Do not touch the exhaust vent area while projecting or immediately after projecting images. The exhaust vent area may be hot at this time and touching it could cause burns.

 **CAUTION**

 PROHIBITED	<p>Moving the projector</p> <ul style="list-style-type: none"> • When carrying the projector, remove the lens unit and carry it with at least two people. Attempting to move the projector alone could result in back pain or other injuries. • When carrying the projector with the lens unit removed, do not touch the mounting area of the lens with your hands. Also, do not put your hand into the recess of the connection terminal. The projector could be damaged or fall down, resulting in injuries. • When moving the projector with the option cover attached, do not hold it by the option cover. The option cover could come lose and the main unit could fall down, causing injuries.
 REQUIRED	<p>Attaching/detaching the lens</p> <ul style="list-style-type: none"> • Turn off the projector and disconnect the power cord before attaching or detaching the lens unit. Failure to do so could result in visual impairment or burns. • Do not attach or detach the lens unit with the projector installed in a high location. The lens unit could fall and cause damage or injury.
 REQUIRED  PROHIBITED	<p>About option cover (separately sold)</p> <ul style="list-style-type: none"> • Be sure to tighten the screws after attaching the option cover. Failure to do so may cause the option cover to come off and fall, resulting in injury or damage to the option cover. • Do not hold the option cover while moving the projector or do not apply excessive force to the option cover. Doing so may damage the option cover, resulting in injury.
 REQUIRED	<p>Avoid locations with extreme temperatures and humidity</p> <ul style="list-style-type: none"> • Failure to do so could lead to fire or electric shock or damage to the projector. The usage environment for this projector is as follows: <ul style="list-style-type: none"> - The operating temperature: 0°C to 45°C / 32°F to 113°F / humidity: 20 to 80% (without condensation) - The storage temperature: -10°C to 50°C / 14°F to 122°F / humidity: 20 to 80% (without condensation)
<p>Inspections and Cleaning</p>	
 REQUIRED	<p>Inspecting the projector and cleaning the inside</p> <ul style="list-style-type: none"> • Consult with your dealer about once per year for cleaning of the inside of the projector. Dust could accumulate inside of the projector if it is not cleaned for extended periods of time, leading to fires or malfunction.

Laser Safety Caution

WARNING

CLASS 1 LASER PRODUCT [IEC 60825-1:2014]

CLASS 1 CONSUMER LASER PRODUCT OF EN 60825-1:2014+A11:2021 (For EU and UK)

- The laser module is equipped in this product. Use of controls or adjustments of procedures other than those specified herein may result in hazardous radiation exposure. Laser energy exposure near aperture may cause burns.
- This product is classified as Class 1 of IEC 60825-1:2014.
- For EU and UK, EN 60825-1:2014+A11:2021 and EN 50689:2021 are also conformed. Except using the lens of NP55ZL and NP56ZL.
- Obey the laws and regulations of your country in relation to the installation and management of the device.

For USA

Complies with 21 CFR 1040.10 and 1040.11 except for conformance as a Risk Group 2 LIP as defined in IEC 62471-5:Ed. 1.0. For more information see Laser Notice No. 57, dated May 8, 2019. However, when using the NP55ZL and NP56ZL lenses, the following applies.

This product is in conformity with performance standards for laser products under 21 CFR 1040, except with respect to those characteristics authorized by Variance Number FDA-2018-V-4413 effective on September 19, 2023.

WARNING

- Do not allow to look into the projector beam at any distance from the projector. An adult should supervise the children to prevent exposure risks.
- Check that there is no one looking at the lens, when using the remote control for starting the projector.
- Do not look at the projected light using optical devices(binoculars, telescopes, magnifying glasses, reflectors, etc).
- [WARNING: MOUNT ABOVE THE HEADS OF CHILDREN.]
The use of a ceiling mount is recommended with this product to place it above the eyes of children.

- Outline of laser emitted from the built-in light module:
 - Wave length: 455 nm
 - Maximum power: 390 W (PA1705UL-W/PA1705UL-B), 346 W (PA1505UL-W/PA1505UL-B)

Light Module

- A light module containing multiple laser diodes is equipped in the product as the light source.
- These laser diodes are sealed in the light module. No maintenance or service is required for the performance of the light module.
- End user is not allowed to replace the light module.
- Contact qualified distributor for light module replacement and further information.

Risk groups

This projector is classified as either IEC/EN 62471-5:2015 risk group 2 or risk group 3 depending on the lens unit.

Risk group 2 (RG2)

 **WARNING**

As with any bright light source, do not stare into the beam, RG2 IEC/EN 62471-5:2015.

Risk group 3 (RG3)

 **WARNING**

RG3 PRODUCT OF IEC/EN 62471-5:2015

- When classified as RG3, this projector is for professional use and must be installed in location where safety is assured. For this reason, be sure to consult your dealer as installation must be performed by a professional installer. Never try to install the projector by yourself. This may result in visual impairment etc.
- No direct exposure to the beam shall be permitted, RG3 IEC/EN 62471-5:2015.
- Do not look into the projector's lens. Serious damage to your eyes could result.
- Operators shall control access to the beam within the hazard distance or install the product at the height that will prevent exposures of spectators' eyes within the hazard distance.
- When turning on the power, operate from the side or rear of the projector (outside the hazard zone). Also, when turning on the power, make sure no one within the projection range is looking at the lens.

• Check before installing the projector

① Lens model name or throw ratio

The lens model name and throw ratio are listed in the image below.

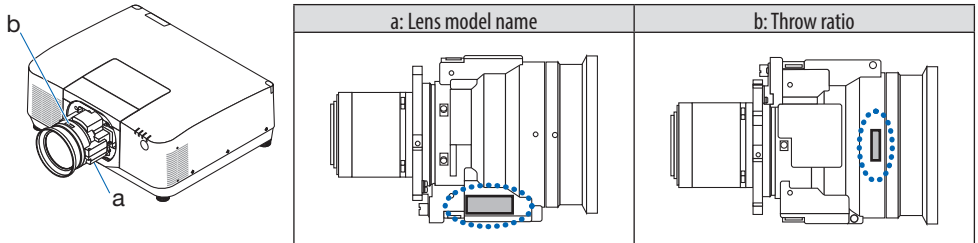

② Combining lens units and risk groups

Lens model name	Throw ratio	PA1705UL-W PA1705UL-B	PA1505UL-W PA1505UL-B
NP51ZL	0.53 - 0.65	RG2	RG2
NP52ZL	0.65 - 0.87		
NP53ZL	0.86 - 1.25		
NP54ZL	1.24 - 2.01	RG3	RG3
NP55ZL	1.98 - 3.95		
NP56ZL	3.95 - 7.51		

• Hazard zone

The below figure describes the radiation zone (hazard zone) of light emitted by the projector that is classified as Risk Group 3 (RG3) of IEC/EN 62471-5:2015.

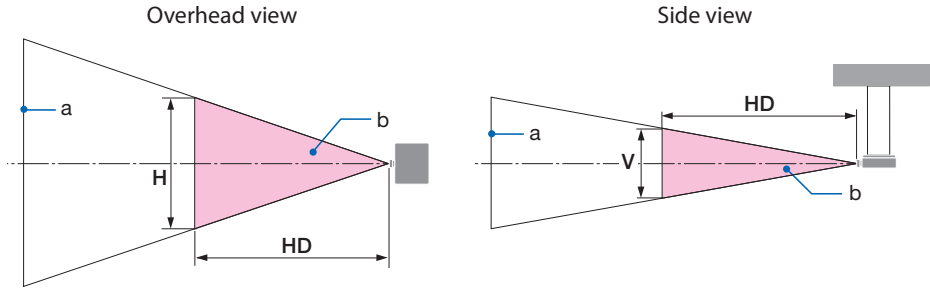

a: Screen / b: Hazard zone

PA1705UL-W/PA1705UL-B

Lens	Throw ratio	Hazard zone (m)		
		HD	H	V
NP55ZL	1.98 (Wide)	-	-	-
	2.60 (Middle)	1.00	0.4	0.3
	3.95 (Tele)	1.65	0.5	0.3
NP56ZL	3.95 (Wide)	1.80	0.4	0.3
	7.51 (Tele)	2.45	0.3	0.2

PA1505UL-W/PA1505UL-B

Lens	Throw ratio	Hazard zone (m)		
		HD	H	V
NP55ZL	1.98 (Wide)	-	-	-
	2.90 (Middle)	1.00	0.4	0.3
	3.95 (Tele)	1.43	0.4	0.3
NP56ZL	3.95 (Wide)	1.55	0.4	0.3
	7.51 (Tele)	2.12	0.3	0.2

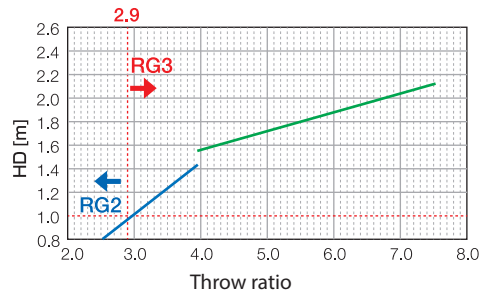
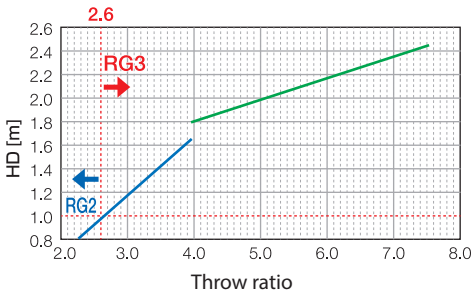

— NP55ZL — NP56ZL

Calculation of the throw ratio

Throw ratio = L: Throw distance (m) / W: Screen width (m)

For throw distances and screen widths, refer to "Lens types and throw distance" in the installation manual.

• About the precautionary zone

By providing a precautionary zone or physical barriers, it is possible to prevent human eyes from entering the hazard zone.

When the manager of the projector (operator) cannot prevent spectators from entering the hazard zone such as in public facilities, it is recommended to secure a space of 1 m or more from the hazard zone as “the precautionary zone” for the safety of the spectators. When installing the projector overhead, it is recommended that the distance between the floor and the hazard zone be at least 3 m in the vertical direction.

In the United States, provide a horizontal distance of 2.5 meters from the hazard zone.

When installthe projector overhead, provide a vertical distance of 3 meters from the floor to the hazard zone.

• Installation example considering the precautionary zone

① Floor or desktop installation example

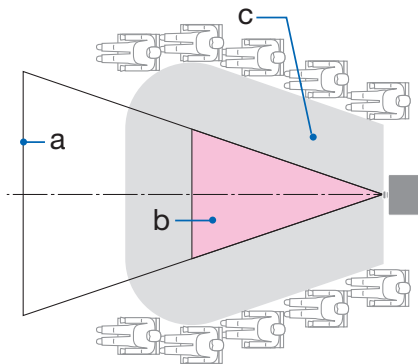

② Ceiling installation example

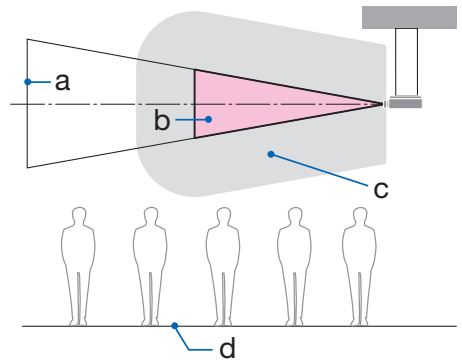

a: Screen / b: Hazard zone / c: Precautionary zone / d: floor

 <p>CAUTION</p>	<p>If it is expected that spectators will intrude into the hazard zone when installed on the ceiling, it is necessary to prevent spectators from entering that area.</p>
---	--

③ **Example of downward projection installed on the ceiling**

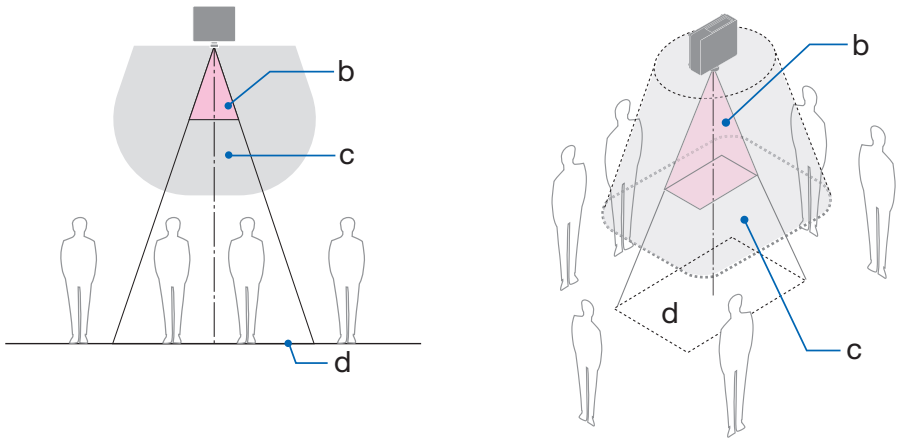

a: Screen / b: Hazard zone / c: Precautionary zone / d: floor

 <p>CAUTION</p>	<p>If the precautionary zone between the floor and the hazard zone cannot be secured, it is necessary to prevent spectators from entering the area around the screen as shown in the figure on the right.</p>
---	---

* If using lens shift, please consider the shift of projected image according to the volume of lens shift. Installation example considering the precautionary zone



Please follow all safety precautions.

Installing the projector

- When planning the layout of the projector, make sure to follow the safety measures listed in the installation Manual.
- In order to avoid danger, either install the device within easy reach of a wall outlet or provide a device like a breaker to disconnect power to the projector in emergency.
- Take safety measures to prevent human eyes from entering the hazard zone.
- Select an appropriate lens for the installation location and secure the safety zone set for each lens.
Ensure that appropriate safety measures have been taken when operating the projector, adjusting the light, etc.
- Check whether the appropriate safety zone for the installed lens has been adequately secured. Periodically check the zone and maintain a record of verifications.

The installer or dealer must instruct the manager (operator) of the projector of the following:

- Educate the manager of the projector (operator) about safety before operating the projector.
- Instruct the manager of the projector (operator) to perform inspections (Including safety checks on light emitted by the projector) before powering the projector on.
- Instruct the manager of the projector (operator) to be able to control the projector whenever the projector is powered on in case of an emergency.
- Instruct the manager of the projector (operator) to keep the installation Manual, user's manual and inspection records in an easy-to-reach place.
- Instruct them to determine whether the projector conforms to the standards of each country and region.

Cable information

Use shielded cables or cables attached ferrite cores so as not to interfere with radio and television reception.

FCC Information (for USA only)

WARNING

- The Federal Communications Commission does not allow any modifications or changes to the unit EXCEPT those specified by Sharp NEC Display Solutions of America, Inc. in this manual. Failure to comply with this government regulation could void your right to operate this equipment.
- This equipment has been tested and found to comply with the limits for a class A digital device, pursuant to Part 15 of the FCC Rules. These limits are designed to provide reasonable protection against harmful interference when the equipment is operated in a commercial environment. This equipment generates, uses, and can radiate radio frequency energy and, if not installed and used in accordance with the instruction manual, may cause harmful interference to radio communications. Operation of this equipment in a residential area is likely to cause harmful interference in which case the user will be required to correct the interference at his own expense.

Supplier's declaration of conformity

This device complies with Part 15 of the FCC Rules. Operation is subject to the following two conditions.

(1) This device may not cause harmful interference, and (2) this device must accept any interference received, including interference that may cause undesired operation.

U.S.Responsible Party: Sharp NEC Display Solutions of America, Inc.
Address: 3250 Lacey Rd, Ste 500
Downers Grove, IL 60515
Telephone Number: 630-467-3000
Type of Product: Projector
Equipment Classification: Class A Peripheral
Model Number: NP-PA1705UL-W/NP-PA1705UL-B/
NP-PA1505UL-W/NP-PA1505UL-B



Notice Concerning Electromagnetic Interference (EMI) (For other regions)

WARNING:

Operation of this equipment in a residential environment could cause radio interference.

(For Customers in U.K.)

IMPORTANT

- The wires in this mains lead are coloured in accordance with the following code:

GREEN-AND-YELLOW:	“Earth”
BLUE:	“Neutral”
BROWN:	“Live”

- As the colours of the wires in the mains lead of this apparatus may not correspond with the coloured markings identifying the terminals in your plug proceed as follows:
- The wire which is coloured GREEN-AND-YELLOW must be connected to the terminal in the plug which is marked by the letter **E** or by the safety earth symbol \perp or coloured green or green-and-yellow.
- The wire which is coloured BLUE must be connected to the terminal which is marked with the letter **N** or coloured black.
- The wire which is coloured BROWN must be connected to the terminal which is marked with the letter **L** or coloured red.
- Ensure that your equipment is connected correctly. If you are in any doubt consult a qualified electrician.

“WARNING: THIS APPARATUS MUST BE EARTHED.”



Disposing of your used product



In the European Union

EU-wide legislation as implemented in each Member State requires that used electrical and electronic products carrying the mark (left) must be disposed of separately from normal household waste. This includes the projector or electrical accessory, such as a power cord. When you dispose of such products, please follow the guidance of your local authority and/or ask the shop where you purchased the product.

After collecting the used products, they are reused and recycled in a proper way. This effort will help us reduce the wastes as well as the negative impact to the human health and the environment at the minimum level.

The mark on the electrical and electronic products only applies to the current European Union Member States.

Outside the European Union

If you wish to dispose of used electrical and electronic products outside the European union, please contact your local authority and ask for the correct method of disposal.



For EU: The crossed-out wheeled bin implies that used batteries should not be put to the general household waste! There is a separate collection system for used batteries, to allow proper treatment and recycling in accordance with legislation.

According to the Regulation (EU)2023/1542, the battery can't be disposed improperly. The battery shall be separated to collect by local service.

(for Germany only)

Machine Noise Information Regulation - 3. GPSGV,

The highest sound pressure level is less than 70 dB (A) in accordance with EN ISO 7779.

Information of the AUDIO OUT mini jack

The AUDIO OUT mini jack does not support earphone/headphone terminal.

Notes on installation and maintenance

Do not install or store in such places as those described below.

- Locations that amplify vibrations and impacts
If installed in places where the vibrations from power sources and the like are conveyed, or in vehicles or on vessels, etc. the projector could be affected by vibrations or shocks that may damage internal parts and lead to malfunction.
- Close to high voltage power lines and power sources
It could disrupt the unit.
- Places where strong magnetic fields are generated
Doing so could lead to malfunction.
- Outdoors and places with humid or dust
Places exposed to oil smoke or steam
Places where corrosive gases are generated
Attached substances such as oil, chemicals and moisture may cause deformation or cracks of the cabinet, corrosion of the metal parts, or malfunction.

To the dealer and the installer

When installing the projector, please see the Installation Manual provided on our web site.

1. To prevent the projector from falling, install it on the ceiling in a way with sufficient strength to withstand the combined weight of the projector and the ceiling mount unit for an extended period of time.
2. When installing the projector on the ceiling, be sure to do so correctly in accordance with the installation Manual for the Ceiling Mount Unit. Be sure to use the fixed metal fittings and to tighten the screws securely.
3. To prevent the projector from falling, use fall prevention wires.
 - Use commercially available metal fittings to join the robust part of a building or construction and the security bar of the projector with the fall prevention wires.
 - Use commercially available metal fittings and fall prevention wires that have sufficient strength to withstand the combined weight of the projector and the ceiling mount unit.
 - Slightly slack off the fall prevention wires so as not to put a load on the projector.
 - Refer to the "Part Names of the Projector" for the location of the security bar. (→ page 6)

Cautions for ensuring the projector's performance

- If intense light like laser beams enters from the lens, it could lead to malfunction.
- Consult your dealer before using in places where much cigarette smoke or dust is present.
- When the same still image is projected for a long period of time with a computer, etc. the pattern of the image may remain on the screen after the projection is stopped, but it will disappear after a while. This happens due to the properties of liquid crystal panels, and is not a malfunction. We recommend using a screensaver on the computer side.
- When the projector is used at high altitudes (places where the atmospheric pressure is low), it may be necessary to replace the optical parts sooner than usual.
- About moving the projector
 - Detach the lens unit once, and be sure to attach the lens cap so as not to scratch the lens. Also, attach a dust protective cap to the projector.
 - Do not subject the projector to vibrations or strong shocks.
The projector could be damaged otherwise.
- Do not use the tilt feet for purposes other than adjusting the projector's tilt.
Improper handling, such as carrying the projector by the tilt feet or using it leaned against a wall, could lead to malfunction.
- The projector does not support stack installation. Do not stack projectors directly on top of each other. Failure to do so may cause damage or failure.
- Do not touch the surface of the projection lens with bare hands.
Fingerprints or dirt on the surface of the projection lens will be enlarged and projected on the screen. Do not touch the surface of the projection lens.
- Do not unplug the power cord from the projector or the power outlet while projecting. Doing so could cause deterioration of the projector's AC IN terminal or power plug contact. To interrupt the AC power supply while images are being projected, use a breaker, etc.
- About handling of the remote control
 - The remote control will not work if the projector's remote signal sensor or the remote control's signal transmitter is exposed to strong light or if there are obstacles between them that obstruct the signals.
 - Operate the remote control from within 20 meters from the projector, pointing it at the projector's remote signal sensor.
 - Do not drop the remote control or handle it improperly.
 - Do not let water or other liquids get on the remote control. Should the remote control get wet, wipe it off immediately.
 - Avoid using in hot and humid places as far as possible.
- Take measures to prevent external light from shining on the screen.
Make sure only the light from the projector shines on the screen. The less external light on the screen, the higher the contrast and the more beautiful the images.
- About screens
Images will not be clear if there is dirt, scratches, discoloration, etc. on your screen. Handle the screen with care, protecting it from volatile substances, scratches and dirt.
- Concerning to all maintenance operations, refer to Installation Manual and follow all instructions properly.

Precautions when installing the projector at an angle

This projector can be installed universally in every angle. When installing the projector at the angles shown below, the separately sold option cover is required to be attached to the projector. For tilted installation of the projector, use a metal fitting with sufficient strength to prevent it from falling.

⚠ WARNING



- Using without the option cover violates safety regulations. Also, powering the projector on without the option cover installed could result in a fire.

Model name of option cover

NP13CV-W for PA1705UL-W/PA1505UL-W

NP13CV-B for PA1705UL-B/PA1505UL-B

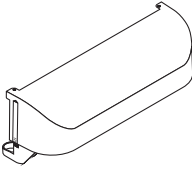
Two covers are packaged with the option cover NP13CV-W and NP13CV-B.

<p>Option cover A: for attaching to the connection terminal area</p>	
<p>Option cover B: for attaching to the exhaust vent</p>	

The drawings below show the installation angle required to attach the option cover A and B respectively.

- Both option cover A and B may need to be attached depending on the installation position of the projector.
- Whether the option cover needs to be attached in the current installation position can be checked on the [INFO.] screen of the on-screen menu.

Installation angles required to attach the option cover A

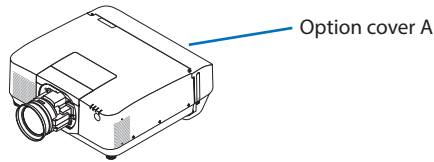

In the direction of back and forth

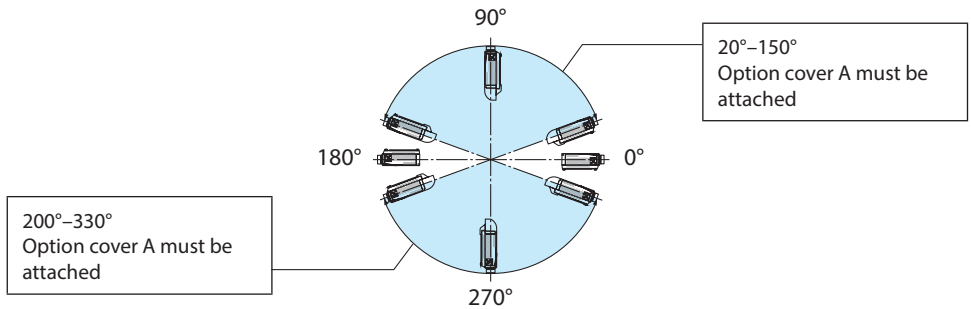

In the direction of left and right

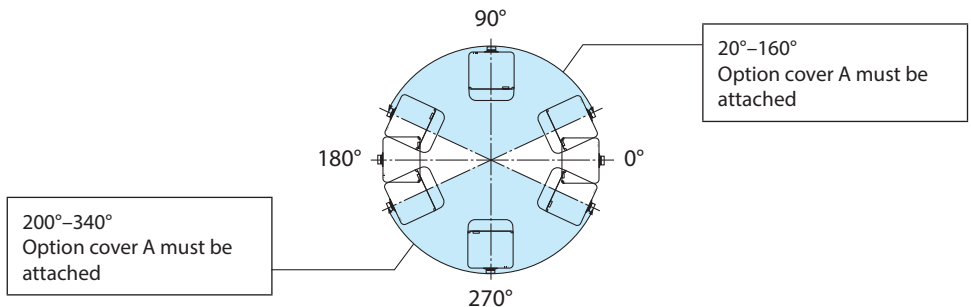

NOTE:

- The drawings show the image of installation angle as a reference. They are slightly different from the actual one.

Installation angles required to attach the option cover B

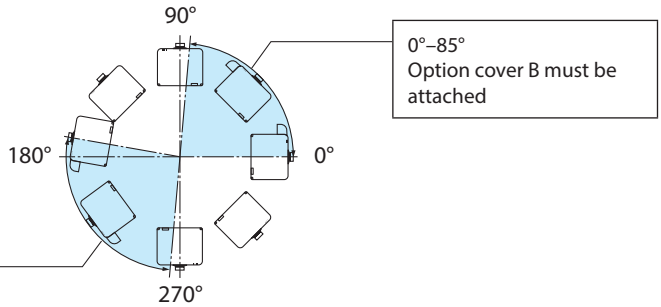
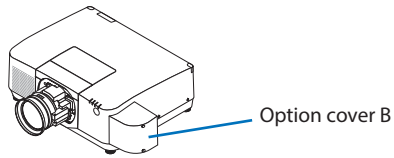

NOTE:

- The drawings show the image of installation angle as a reference. They are slightly different from the actual one.

Clearance for Installing the Projector

- When installing the projector, keep sufficient space around it, as described below. If not, the hot exhaust emitted from the projector may be taken back in. Also, make sure no wind from an air-conditioner hits the projector. The projector's heat control system may detect an abnormality (temperature error) and automatically shut off the power.

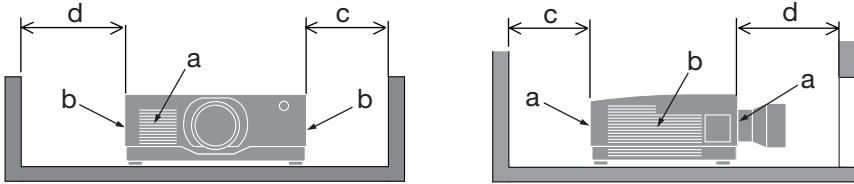

a: Intake vent / b: Exhaust vent / c: 20 cm/8" or greater / d: 30 cm/12" or greater

NOTE:

- In the above figure, it is assumed that there is sufficient space above the projector.
 - If the option cover is installed, leave a space of 20 cm/8" between the projector and the option cover.
- When using multiple projectors together for multi-screen projection, provide sufficient space around the projectors for air intake and exhaust. When the intake and exhaust vents are obstructed, the temperature inside the projector will rise and this may result in a malfunction.



About Copyright of original projected pictures:

Please note that using this projector for the purpose of commercial gain or the attraction of public attention in a venue such as a coffee shop or hotel and employing compression or expansion of the screen image with the following functions may raise concern about the infringement of copyrights which are protected by copyright law.

[ASPECT RATIO], [KEYSTONE], Magnifying feature and other similar features.

[AUTO POWER OFF] Function

The factory default setting for [AUTO POWER OFF] is 15 minutes. If no input signal is received and no operation is performed on the projector during 15 minutes, the projector is automatically powered off for saving the power consumption. In order to control the projector by an external device, set the [AUTO POWER OFF] to [OFF].

Trademarks

- Cinema Quality Picture logo, ProAssist, and Virtual Remote are trademarks or registered trademarks of Sharp NEC Display Solutions, Ltd. in Japan, in the United State and other countries.
- The terms HDMI, HDMI High-Definition Multimedia Interface, HDMI Trade dress and the HDMI Logos are trademarks or registered trademarks of HDMI Licensing Administrator, Inc.



- HDBaseT™ and the HDBaseT Alliance logo are trademarks of the HDBaseT Alliance.



- Trademark PJLink is a trademark applied for trademark rights in Japan, the United States of America and other countries and areas.
- Blu-ray is a trademark of Blu-ray Disc Association.
- CRESTRON and CRESTRON ROOMVIEW are trademarks or registered trademarks of Crestron Electronics, Inc. in the United States and other countries.
- Extron and XTP are registered trademarks of RGB Systems, Inc. in the United States.
- Art-Net™ Designed by and Copyright Artistic Licence Holdings Ltd.
- Other product and company names mentioned in this user's manual may be the trademarks or registered trademarks of their respective holders.
- Virtual Remote Tool uses WinI2C/DDC library, © Nicomsoft Ltd.

1. Check the product overview, supplied items and part names

1-1. Introduction to the Projector

This section introduces you to your new projector and describes the features and controls.

- **Liquid crystal type high brightness/high resolution projector**

This projector has a display resolution of 1920 dots × 1200 lines (WUXGA) and an aspect ratio of 16:10.

Model	Brightness
PA1705UL-W/PA1705UL-B	16000 lm (Center 17000 lm)
PA1505UL-W/PA1505UL-B	14000 lm (Center 15000 lm)

- **A long-life laser diode is equipped in the light module**

The laser light source has a long service life, so replacement, adjustment, and other maintenance should not be necessary for an extended period of time.

- **A proprietary sealed structure that achieves highly dust-proof performance**

Due to its excellent dust-proof performance, the projector is not equipped with a filter. Filter replacement is therefore unnecessary.

- **Wide range of optional lenses selectable according to the place of installation**

This projector supports 6 types of optional lenses, providing a selection of lenses adapted to a variety of places of installation and projection methods.

Note that no lens is mounted upon shipment from the factory. Please purchase optional lenses separately.

- **360 degree free projection**

The projector is equipped with a “tilt-free” function for 360° projection vertically and a “roll-free” function for 360° projection horizontally.

Note, however, that the separately sold option cover is required to be attached to the projector depending on the installation angle of the projector.

- **High quality pictures using Cinema Quality Picture technology**

The projector displays extremely high quality pictures by combining the technology used to develop digital cinema projectors with the image processing technologies we have amassed over our countless years of developing projectors.



- **Multi-screen projection using multiple projectors**

This projector equips the HDBaseT IN and HDBaseT OUT ports. Using a LAN cable, control signals can be transmitted in addition to the audio/visual signals (up to four devices can be connected).

The edge blending function creates smooth borders when using multiple units to project a single image.

1. Check the product overview, supplied items and part names

- **Simultaneous display of 2 images (PIP/PICTURE BY PICTURE)**

Two images can be projected simultaneously with a single projector.

There are two types of layouts for the two images: [PIP] in which a sub-picture is displayed on the main picture, and [PICTURE BY PICTURE] in which the main and sub pictures are displayed next to each other.

- **Seamless switch function for smoother screen changes when switching the signal**

When the input connector is switched, the image displayed before switching is held so that that the new image can be switched to without a break due to absence of a signal.

- **Supports wired LAN**

Equips the LAN and HDBaseT ports. Utilizing a wired LAN connected with these ports, it enables to control the projector by a computer.

- **Convenient software applications**

Compatible with our software applications (NaViSet Administrator 2, ProAssist, Virtual Remote Tool, etc.). The projector can be controlled from a computer connected via a wired LAN.

- NaViSet Administrator 2

You can monitor the status of the projector and control a variety of functions.

- ProAssist

Necessary adjustments can be made smoothly for multi-screen projection.

- Virtual Remote Tool

A virtual remote control is displayed on the computer screen to perform simple controls such as turning the projector on/off, switching signals, etc. It is also possible to change the background logo of the projector.

Please visit our web site for downloading each software.

URL: <https://www.sharp-nec-displays.com/dl/en/index.html>

- **CRESTRON ROOMVIEW and Extron XTP compatibility**

The projector supports CRESTRON ROOMVIEW and Extron XTP, allowing multiple devices connected in the network to be managed and controlled from a computer. Moreover, it enables to output and control image via an Extron XTP transmitter connected with the projector.

- **Energy-saving design with a standby power consumption of 0.15 W (100-130 V AC) / 0.20 W (200-240 V AC)**

Selecting [ON] for [POWER-SAVING] from the menu can put the projector in power-saving mode.

When network is enabled: 0.4 W (100-130 V AC)/0.5 W (200-240 V AC)

When the network is disabled: 0.15 W (100-130 V AC)/0.20 W (200-240 V AC)

1. Check the product overview, supplied items and part names

- **[LIGHT MODE] and “Carbon Meter” display**

Three [LIGHT MODE] options can be selected according to the purpose of use. [LIGHT ADJUST] can also be used to reduce output power and control energy consumption. The energy-saving effect from that time will be factored into the amount of reduced CO₂ emissions and displayed in the confirmation message when turning the power off as well as the [INFO.] area in the on-screen menu (CARBON METER)

1. Check the product overview, supplied items and part names

1-2. What's in the Box?

Make sure your box contains everything listed. If any pieces are missing, contact your dealer. Please save the original box and packing materials if you ever need to ship your projector.

Projector

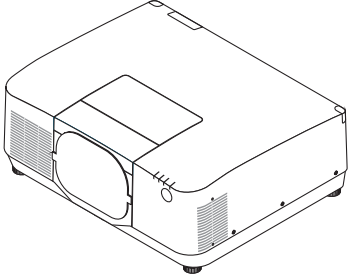

Dust cap for lens (9NER0271)

* The projector is shipped without a lens.

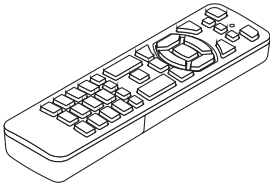

Remote control (7N901322)

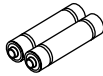

AAA alkaline batteries (x2)

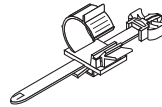

Power cord stopper (24C10881)

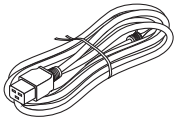

Power cord

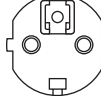
Plug type	
For USA	For EU
	
7N080534	7N080032

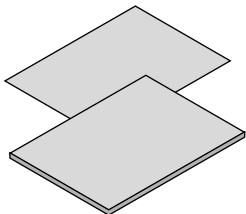

- **Important Infomation**
(TINS-0015VW02)
- **Quick Setup Guide**
(TINS-0016VW01)
- **Security Sticker**
(Use this sticker when security password is set on.)

For USA and Canada only

Limited warranty

For customers in Europe

You will find our current valid Guarantee Policy on our Web Site:

<https://www.sharpnecdisplays.eu>

1-3. Part Names of the Projector

Front

The lens is sold separately. The description below is for when the NP54ZL lens is mounted.

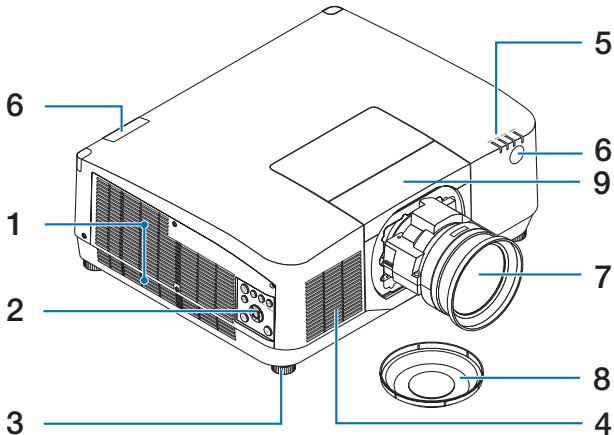

1. Exhaust vent

Heated air is exhausted from here.

2. Controls

The projector's power can be turned ON/OFF, and the signal for the projected image can be switched here.

3. Adjustable Tilt Foot

Rotate the tilt feet to adjust the left/right orientation.

4. Intake vent

Takes in outside air to cool the unit.

5. Indicator Section

The indicator light turns on or blinks to relay the status of the projector (Power ON/Standby/etc.)

6. Remote Sensor

This part receives signals from the remote control. There are two locations on the front and back of the projector.

7. Lens

Images are projected from here. (Lens unit sold separately.)

8. Lens Cap

(The optional lens is shipped with the lens cap.)

9. Lens cover

Remove this when installing and removing a lens unit.

1. Check the product overview, supplied items and part names

Rear

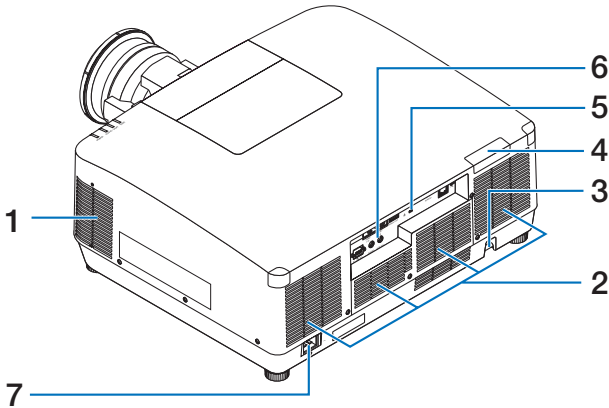

1. Exhaust vent

Heated air is exhausted from here.

2. Intake vent

Takes in outside air to cool the unit.

3. Security Bar

Attach an anti-theft device. The security bar accepts security wires or chains up to 0.18 inch/4.6 mm in diameter.

4. Remote Sensor

This part receives signals from the remote control. There are two locations on the front and back of the projector.

5. Security Slot (🔒)*

This is used when attaching an anti-theft cable.

6. Terminals

Connect the cables for the various audio and video signals.

7. AC IN Terminal

Connect the supplied power cord's three-pin plug here, and plug the other end into an active wall outlet.

* Security and theft protection lock compatible with Kensington security cables/equipment. For products, visit Kensington's website.

Controls/Indicators

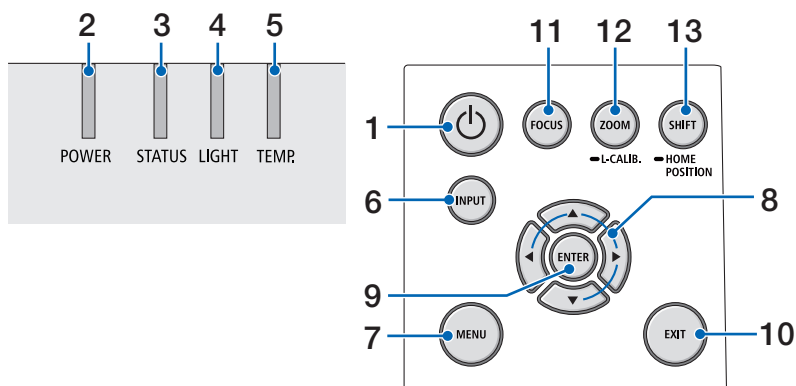

1. (POWER) Button

Switches between projector's power on and standby.

When turning off the power (standby), pressing the button once will bring up a confirmation message on the screen, so press the button one more time.

2. POWER Indicator

Indicates the projector's power state. The indicator lights up in blue when the power is on. Depending on the state of power, it will light up or blink in either green or orange when power is off. Refer to the "Indicator Message" section for details.

(→ page 40)

3. STATUS Indicator

This lights up or blinks when an operation button is pressed while the unit is in key lock mode, while the lens is calibrating, etc. Refer to the "Indicator Message" section for details.

(→ page 40)

4. LIGHT Indicator

Indicates the state of the light source.

5. TEMP. Indicator

Indicates high temperatures around the projector.



6. INPUT Button

Selects the input signal. Pressing it quickly will display the input selection screen. Pressing it for one second or longer will begin a series of automatic checks in the order of HDMI1 → HDMI2 → HDBaseT → SDI, and if an input signal is detected then that signal will be projected.

7. MENU Button

Displays the on-screen menu for various settings and adjustments.

8. / Volume Buttons

- When the on-screen menu is displayed, use the  buttons to select the item that you wish to set or adjust.
- Changes the pattern when the test pattern is displayed.
- When the on-screen menu is not displayed, use the  buttons to adjust the sound output from the projector.

1. Check the product overview, supplied items and part names

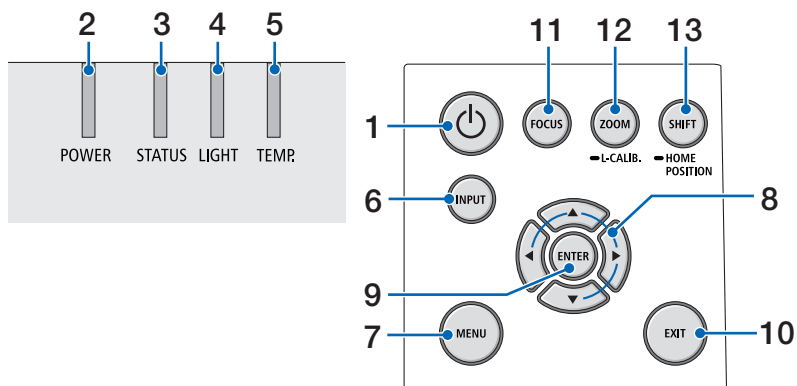

9. ENTER Button

Moves to the next menu when the on-screen menu is displayed. Confirms the item when the confirmation message is displayed.

10. EXIT Button

Returns to the menu on the previous level when the on-screen menu is displayed. Closes the menu when a cursor appears in the main menu. Cancels the operation when the confirmation message is displayed.

11. FOCUS Button

Open the focus adjustment screen and focus the projected image.

12. ZOOM/L-CALIB. Button

- Short press to open the zoom adjustment screen. Finely adjust the size of the projected image.
- Long press (two seconds or longer) to correct the adjustment range of the attached lens unit (calibration).

13. SHIFT/HOME POSITION Button

- Short press to display the lens shift screen. Adjust them using the ▼▲◀▶ buttons.
- Long press (2 seconds or longer) to return the lens shift adjustment to its initial position.

1. Check the product overview, supplied items and part names

Terminal Panel Features

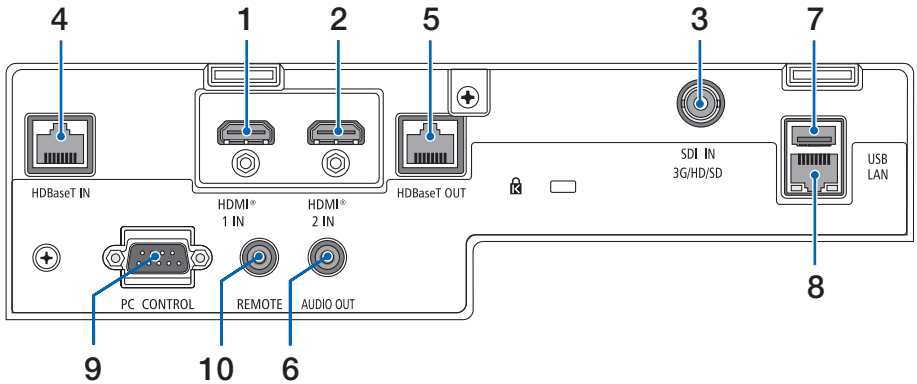

1. HDMI 1 IN Terminal (Type A)

Connects to the output terminals of a computer, blu-ray player, etc.

2. HDMI 2 IN Terminal (Type A)

Connects to the output terminals of a computer, blu-ray player, etc.

3. SDI IN Terminal (BNC)

Connects to the SDI output terminal on the video device.

4. HDBaseT IN Port (RJ-45)

Connects to a commercially available HD-BaseT compatible transmission devices.

Also used when connecting multiple projectors in daisy chaining.

5. HDBaseT OUT Port (RJ-45)

Outputs incoming signals from the HDMI 1 IN terminal, HDMI 2 IN terminal, and HDBaseT IN Port.

6. AUDIO OUT Mini Jack (Stereo Mini)

Outputs the audio signal corresponding to the image projected from the projector. The output volume can be adjusted using the ◀ / ▶ buttons.

7. USB Port (Type A)

Connect a commercially available USB mouse and use it to navigate the menu.

NOTE:

- Not guarantee the performance of all USB mouse available on the market.

8. LAN Port (RJ-45)

Connects the unit to a wired LAN.

9. PC CONTROL Port (D-Sub 9 Pin)

Use this port to connect a PC or control system. This enables you to control the projector using serial communication protocol.

1. Check the product overview, supplied items and part names

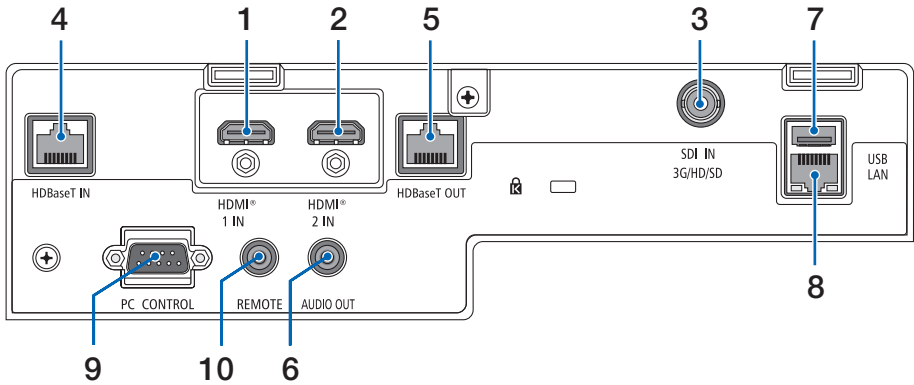

10. REMOTE Terminal (Stereo Mini)

Use this terminal for wired remote control of the projector.

NOTE:

- When a remote control cable is connected to the REMOTE terminal, infrared remote control operations cannot be performed.
- When [HDBaseT] is selected in the [REMOTE SENSOR] and the projector is connected to a commercially-available transmission device that supports HDBaseT, remote control operations in infra-red cannot be carried out if transmission of remote control signals has been set up in the transmission device. However, remote control using infrared rays can be carried out when the power supply of the transmission device is switched off.

1. Check the product overview, supplied items and part names

1-4. Part Names of the Remote Control

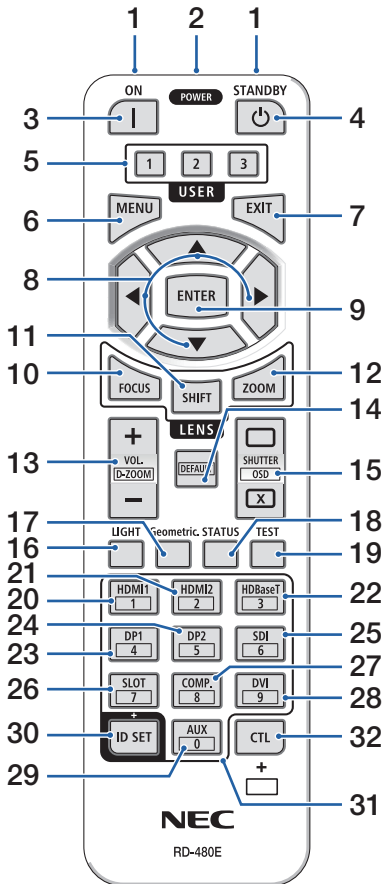

1. Infrared Transmitter

Remote control signals are sent via infrared signal. Point the remote control at the remote control receiver on the projector.

2. Remote Jack

Connect a commercially available remote cable here for wired operation.

3. POWER ON Button (|)

Turns power ON when in sleep or standby mode.

4. POWER STANDBY Button (⏻)

Pressing the button once will display the shutdown confirmation message. Press the POWER STANDBY (or ENTER) button once more to power down the projector.

5. USER 1/2/3 Button

The following 14 functions can be selected and set. When the character input screen is displayed, use this to switch the character keyboard, insert a space, and erase characters.

6. MENU Button

Displays the on-screen menu for various settings and adjustments.

7. EXIT Button

Returns to the menu on the previous level when the on-screen menu is displayed. Closes the menu when a cursor appears in the main menu. Cancels the operation when the confirmation message is displayed.

8. ▲▼◀▶ Button

- When the on-screen menu is displayed, use the ▲▼◀▶ buttons to select the item that you wish to set or adjust.
- Changes the pattern when the test pattern is displayed.

1. Check the product overview, supplied items and part names

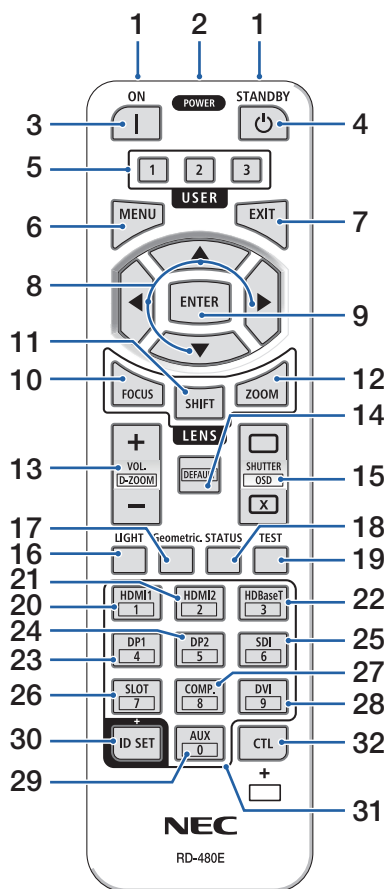

9. ENTER Button

Moves to the next menu when the on-screen menu is displayed. Confirms the item when the confirmation message is displayed.

10. FOCUS Button

Opens the focus adjustment screen. Adjust the focus (of the lens) with the ◀ / ▶ buttons.

11. SHIFT Button

The lens shift adjustment screen will be displayed. Use the ▼▲◀▶ buttons to adjust the lens position.

12. ZOOM Button

Opens the zoom adjustment screen. Adjust zoom with the ◀ / ▶ buttons.

13. VOL./D-ZOOM (+)(-) Button

Adjusts the volume level of the audio output terminals. Simultaneously pressing the CTL button will expand or shrink the image (return to the original state).

14. DEFAULT Button

Simultaneously pressing the CTL button when the on-screen menu is displayed will reset the adjustment values.

This only works for the items with DEFAULT displayed in the Operation Guide.

15. SHUTTER/OSD OPEN (□)/CLOSE (X) Button

Press the CLOSE button to turn off the light source and temporarily stop projection. Press the OPEN button to resume. Simultaneously press the CTL and CLOSE buttons to close the on-screen display (On-Screen Mute). Simultaneously press the CTL and OPEN buttons to go back.

16. LIGHT Button

Displays the light mode screen.

NOTE:

- The settings in [ADJUST] → [PICTURE] → [MODE] change the screen displayed.

1. Check the product overview, supplied items and part names

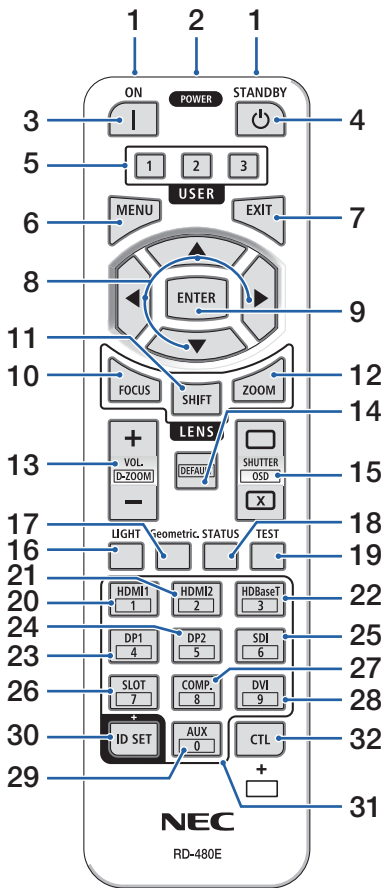

17. Geometric. Button

Displays [GEOMETRIC CORRECTION] from the on-screen menu. Use it to adjust distortions in projected images.

18. STATUS Button

Displays [USAGE TIME] of [INFO.] from the on-screen menu.

19. TEST Button

Projects a test pattern.

20. HDMI1 Button

Selects the HDMI1 input.

21. HDMI2 Button

Selects the HDMI2 input.

22. HDBaseT Button

Selects the HDBaseT input.

23. DP1 Button

(Not available on this series of projectors.)

24. DP2 Button

(Not available on this series of projectors.)

25. SDI Button

Selects the SDI input.

26. SLOT Button

(Not available on this series of projectors.)

27. COMP. Button

(Not available on this series of projectors.)

28. DVI Button

(Not available on this series of projectors.)

29. AUX Button

(Not available on this series of projectors. For future expansion)

1. Check the product overview, supplied items and part names

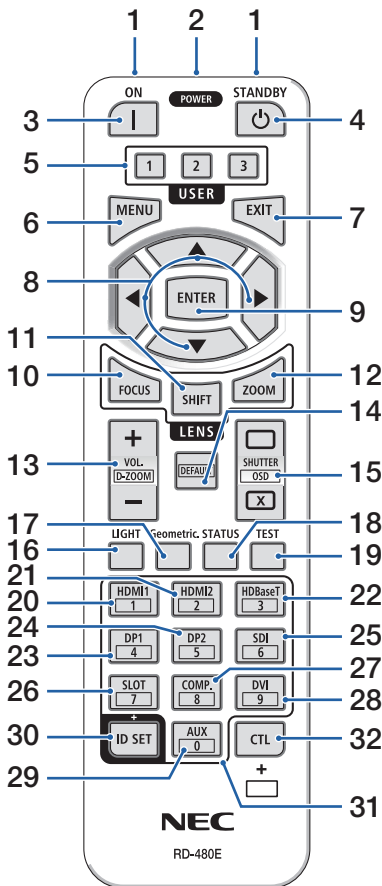

30. ID SET Button

Used to set the control ID when performing individual operations on multiple projectors using the remote control. Also used to toggle the character keyboard when the character input screen is displayed.

31. Numeric Keypad Button

Used to input the control ID when performing individual operations on multiple projectors using the remote control (set the control ID). Pressing the 0 button while holding down the ID SET button will remove any control ID settings. Used to enter alphanumeric characters directly when the character input screen is displayed.

32. CTL Button

This is a multipurpose button for combined use with other buttons.

1. Check the product overview, supplied items and part names

Battery Installation

1. Press the catch and remove the battery cover.

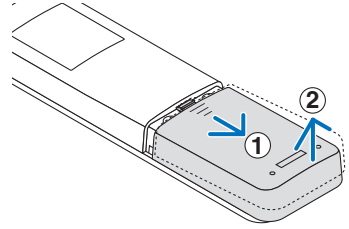

2. Install new ones (AAA). Ensure that you have the batteries' polarity (+/-) aligned correctly.

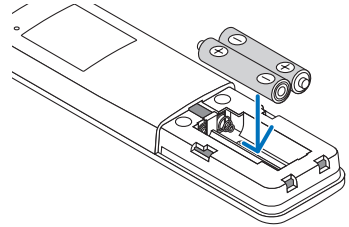

3. Slip the cover back over the batteries until it snaps into place.

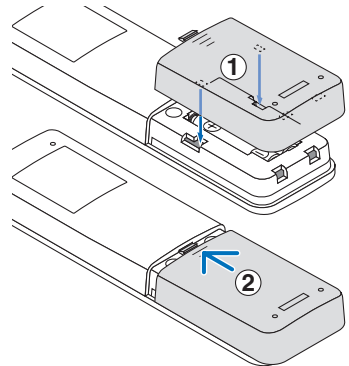

NOTE:

- Do not mix different types of batteries or new and old batteries.
-

Remote Control Precautions

- Handle the remote control carefully.
- If the remote control gets wet, wipe it dry immediately.
- Avoid excessive heat and humidity.
- Do not short, heat, or take apart batteries.
- Do not throw batteries into fire.
- If you will not be using the remote control for a long time, remove the batteries.
- Ensure that you have the batteries' polarity (+/-) aligned correctly.
- Do not use new and old batteries together, or use different types of batteries together.
- Dispose of used batteries according to your local regulations.
- Please note that if multiple projectors are installed nearby, other projectors may unintentionally light up when you turn on the power using the remote control.

1. Check the product overview, supplied items and part names

Operating Range for Wireless Remote Control

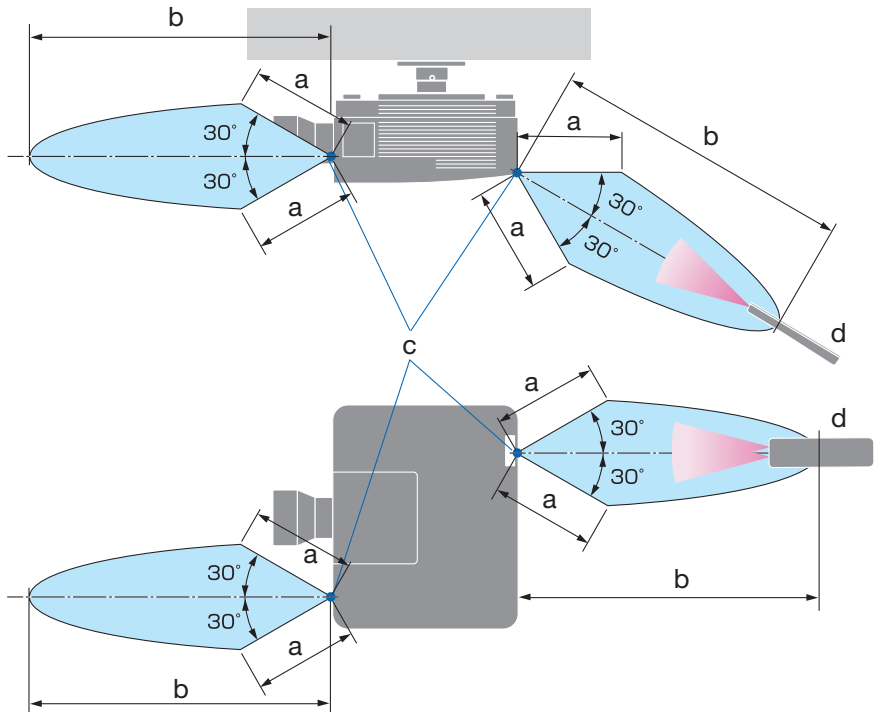

a: 7 m/276" / b: 20 m/787" / c: Remote sensor on projector cabinet / d: Remote control

- The projector will not respond if there are objects between the remote control and the sensor, or if strong light falls on the sensor. Weak batteries will also prevent the remote control from properly operating the projector.

1. Check the product overview, supplied items and part names

Using the Remote Control in Wired Operation

Connect one end of the remote cable to the REMOTE terminal and the other end to the remote jack on the remote control.

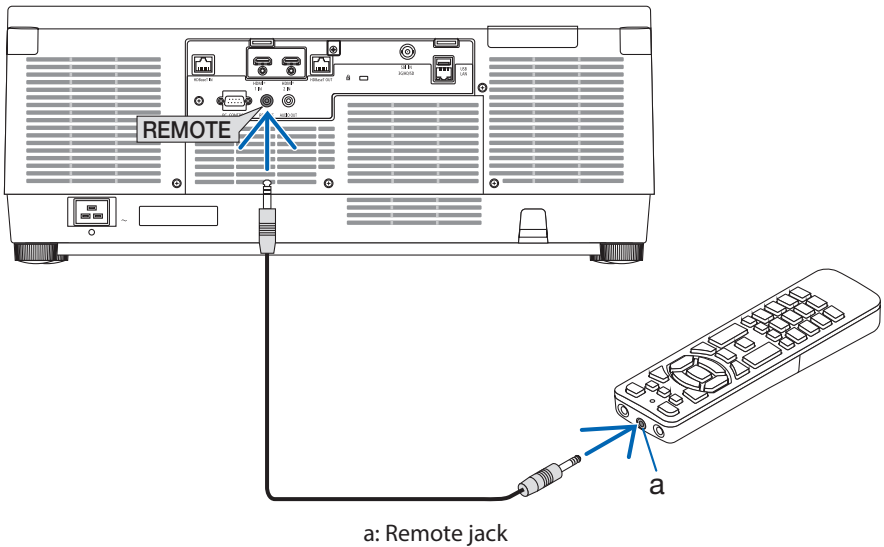

NOTE:

- When a remote cable is inserted into the REMOTE terminal, the remote control does not work for infrared wireless communication.
- Power will not be supplied to the remote control by the projector via the REMOTE jack. Battery is needed when the remote control is used in wired operation.

2. Projecting an Image (Basic Operation)

This section describes how to turn on the projector and to project a picture onto the screen.

2-1. Flow of Projecting an Image

Step 1

- **Connecting your computer / Connecting the power cord** (→ [page 19](#))



Step 2

- **Turning on the projector** (→ [page 22](#))



Step 3

- **Selecting a source** (→ [page 25](#))



Step 4

- **Adjusting the picture size and position** (→ [page 27](#))



Step 5

- **Adjusting a picture and sound** (→ [page 34](#))



Step 6

- **Making a presentation**



Step 7

- **Turning off the projector** (→ [page 35](#))



Step 8

- **After use** (→ [page 36](#))

2-2. Connecting Your Computer/Connecting the Power Cord

1. Connect your computer to the projector.

This section will show you a basic connection to a computer.

Connect a commercially available HDMI cable between the computer's HDMI output connector and the projector's HDMI 1 IN or HDMI 2 IN connector.

2. Connect the supplied power cord to the projector.

First connect the supplied power cord's three-pin plug to the AC IN terminal of the projector, and then connect another plug of the supplied power cord directly in the wall outlet. Do not use any plug converter.



CAUTION:

- This equipment is designed to be used in the condition of the power cord connected to earth. If the power cord is not connected to the earth, it may cause electric shock. Please make sure the power cord is connected to the wall outlet directly and earthed properly. Do not use a 2-core plug converter adapter.
- Be sure to connect the projector and the computer (signal source) to the same earth point. If the projector and the computer (signal source) will be connected to different earth points, fluctuations in the earth potential may cause fire or smoke.
- To prevent the power cord from coming loose, make sure that all the prongs of the power cord plug are fully inserted into the AC IN terminal of the projector before using the power cord stopper. A loose contact of the power cord may cause a fire or electric shock.

Upon connecting the power cable, the POWER indicator of the projector will light.

2. Projecting an Image (Basic Operation)

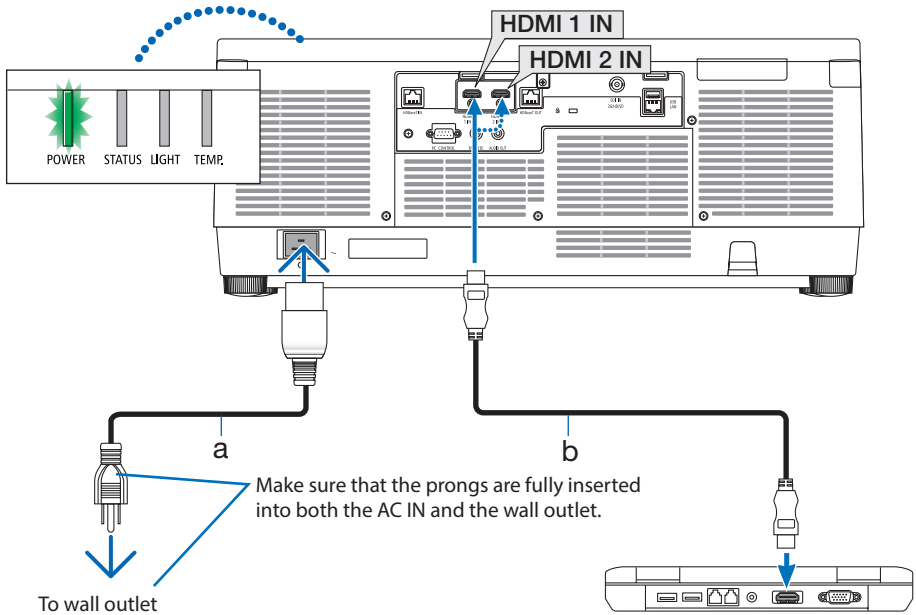

a: Power cord (supplied) / b: HDMI cable (not supplied)

- Use a Premium High Speed HDMI Cable.

CAUTION:

Parts of the projector may become temporarily heated if the projector is turned off with the POWER button or if the AC power supply is disconnected during normal projector operation. Use caution when picking up the projector.

Using the power cord stopper

To prevent the power cord from accidentally removing from the AC IN of the projector, use the power cord stopper.

NOTE:

- If you pull on the power supply cord while the connector is fixed, the main unit may fall down and be damaged

- ① With the clammer facing the power supply cord, align the tip of the power supply cord stopper with the hole below the AC IN terminal and push it in.
- ② Pass the power supply cord through the clammer and press the clammer to fix it.
- ③ Slide the clammer until the base of the power plug.

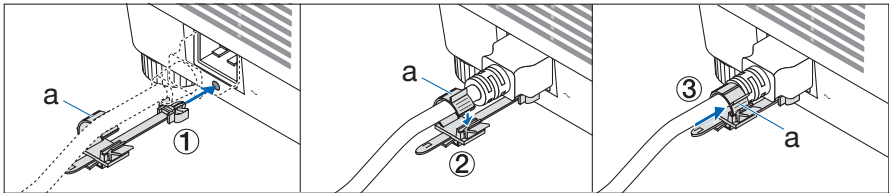

a: Clammer

2-3. Turning on the Projector

WARNING

The projector produces a strong light. When turning on the power, operate from the side or rear of the projector (outside the hazard zone). Also, when turning on the power, make sure no one within the projection range is looking at the lens.

1. Remove the lens cap.

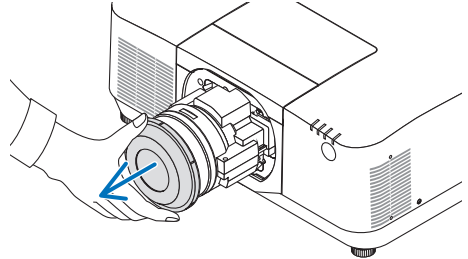

2. Press the (POWER) button on the projector cabinet or the POWER ON button on the remote control.

The POWER indicator lit in green will start to blink in blue. After that, the image will be projected onto the screen.

TIP:

- When the message "PROJECTOR IS LOCKED! ENTER YOUR PASSWORD." is displayed, it means that the [SECURITY] feature is turned on.

After you turn on your projector, ensure that the computer or video source is turned on.

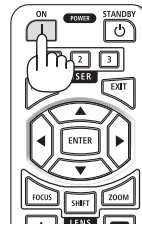

NOTE:

- A blue screen (blue background) is displayed when no signal is being input (by factory default menu settings).

Performing Lens Calibration

After mounting the separately available lens unit or replacing a lens unit, perform [LENS CALIBRATION] by holding to press ZOOM/L-CALIB. button on the cabinet over two seconds.

Calibration corrects the adjustable zoom, shift, and focus range. If calibration is not performed, you may not be able to get the best focus and zoom even if you adjust the focus and zoom for the lens.

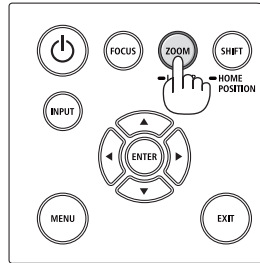

Note on Startup screen (Menu Language Select screen)

When you first turn on the projector, you will get the Startup menu. This menu gives you the opportunity to select one of the 30 menu languages.

To select a menu language, follow these steps:

1. Use the ▲, ▼, ◀ or ▶ button to select one of the 30 languages from the menu.

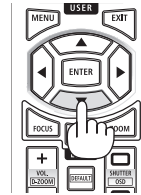

2. Press the ENTER button to execute the selection.

After this has been done, you can proceed to the menu operation.

If you want, you can select the menu language later.

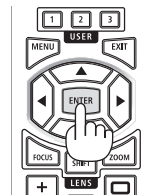

NOTE:

- If the message, [PLEASE SET "DATE AND TIME".] is shown, please set the current date and time.
In the case this message is not shown, the [DATE AND TIME SETTINGS] is recommended to complete.
- Keep the lens cap off the lens while the projector's power is on.
If the lens cap is on, it could be warped due to high temperature.
- If the STATUS indicator lights orange with the power button pressed, the projector will not be turned on since the [CONTROL PANEL LOCK] has been [ON]. Cancel the lock by turning it off.
- While the POWER indicator is blinking blue in short cycles, the power cannot be turned off by using the power button.
- If the projector is kept in sleep mode or other similar state, the temperature of the internal components could rise even when the projector is being used within its normal operating temperature. If the power is turned on in that state, the cooling fan will turn on and the image will be projected after a short while.

2-4. Selecting a Source

Selecting the computer or video source

NOTE:

- Turn on the computer or video source equipment connected to the projector.

Detecting the Signal Automatically

Press the INPUT button for 1 second or longer. The projector will search for the available input source and display it. The input source will change as follows:

HDMI1 → HDMI2 → HDBaseT → SDI → HDMI1 → ...

- Press it briefly to display the [INPUT] screen.

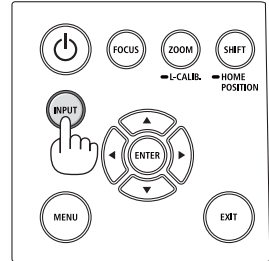

- Press the ▼/▲ buttons to match the target input terminal and then press the ENTER button to switch the input. To delete the menu display in the [INPUT] screen, press the MENU or EXIT button.

TIP:

- If no input signal is present, the input will be skipped.

Using the Remote Control

Press any one of the HDMI1, HDMI2, HDBaseT, or SDI button.

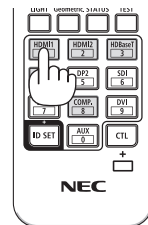

Selecting Default Source

You can set a source as the default source so that it will be displayed each time the projector is turned on.

1. Press the MENU button.

The menu will be displayed.

2. Press the ► button to select [SETUP] and press the ▼ button or the ENTER button to select [MENU(1)].

3. Press the ► button to select [SOURCE OPTIONS] and press the ▼ button or the ENTER button.

4. Select [DEFAULT INPUT SELECT] and press the ENTER button.

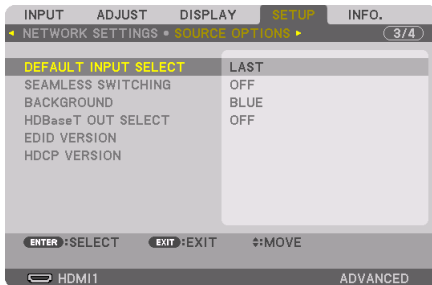

The [DEFAULT INPUT SELECT] screen will be displayed.

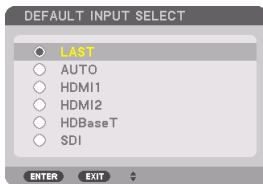

5. Select a source as the default source, and press the ENTER button.

6. Press the EXIT button a few times to close the menu.

7. Restart the projector.

The source you selected in step 5 will be projected.

2-5. Adjusting the Picture Size and Position

Use the lens shift, the adjustable tilt foot, the zoom and the focus to adjust the picture size and position.

In this chapter drawings and cables are omitted for clarity.

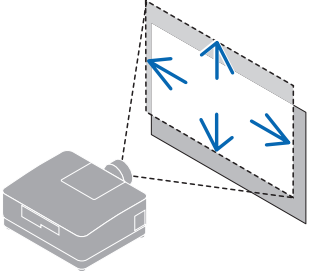
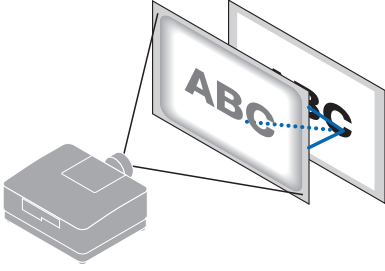
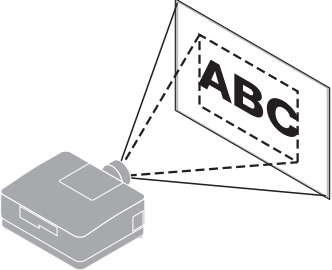
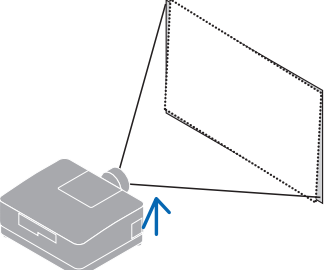
<p>Adjusting the projected image's vertical and horizontal position "Lens shift" (→ page 28)</p>  A diagram showing a projector on the left projecting an image of the letters 'ABC' onto a screen. Four blue arrows point outwards from the center of the image, indicating the direction of lens shift for vertical and horizontal positioning.	<p>Adjusting the focus "Focus" (→ page 30)</p>  A diagram showing a projector on the left projecting an image of the letters 'ABC' onto a screen. A blue dotted line with arrows at both ends passes through the center of the image, representing the focus adjustment mechanism.
<p>Finely adjusting the size of an image "Zoom" (→ page 32)</p>  A diagram showing a projector on the left projecting an image of the letters 'ABC' onto a screen. A dashed rectangular box is drawn around the image, indicating the zoomed-in area.	<p>Adjusting the projected image's inclination "Tilt foot" (→ page 33)</p>  A diagram showing a projector on the left projecting an image onto a screen. A blue arrow points upwards from the bottom of the projector, indicating the tilt foot adjustment.

Adjusting the vertical position of a projected image (Lens shift)

CAUTION

- Perform the adjustment from behind or from the side of the projector. If adjustments are performed from the front, your eyes could be exposed to strong light and get injured.
- Keep hands away from the lens mounting portion while performing a lens shift. Failure to do so could result in fingers being pinched by the moving lens.

1. Press either **SHIFT/HOME POSITION** button on the cabinet or **SHIFT** button on the remote control.

The [LENS SHIFT] screen will be displayed.

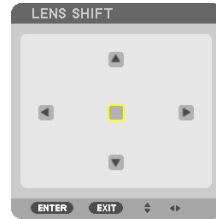

2. Press the **▼▲◀▶** buttons to move the projected image.

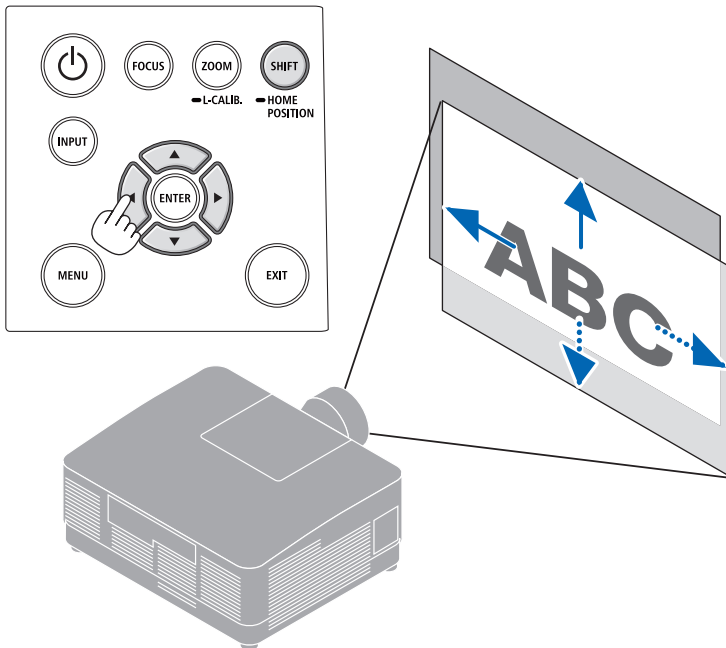

To set back the lens to the home position

Press and hold the **SHIFT/HOME POSITION** button over 2 seconds. The lens mounted on the projector goes back to the home position. (roughly to the center position)

2. Projecting an Image (Basic Operation)

NOTE:

- If the lens is shifted to the maximum in the diagonal direction, the screen peripheral area will be dark or shaded.

TIP:

- The figure below shows the lens shift adjustment range (projection method: Desktop/Front) of the NP54ZL lens unit.

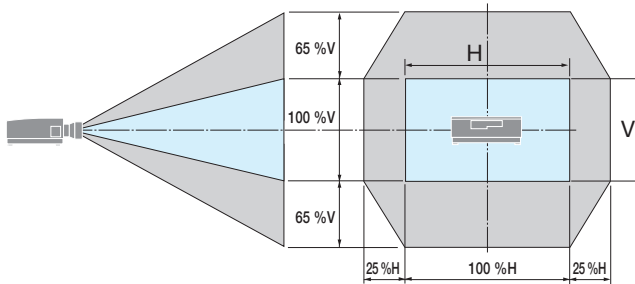

Description of symbols: V indicates vertical (height of the projected image), H indicates horizontal (width of the projected image).

Focus

Recommend to perform the focus adjustment after leaving the projector under the state the TEST PATTERN has been projected for over 30 minutes.

Applicable lens: NP51ZL/NP52ZL/NP53ZL

1. Press the FOCUS button.

The [LENS FOCUS] control screen will be displayed on.



Press ◀▶ buttons to adjust focus.

2. When the cursor is on the [CENTER] on on-screen menu, press either ◀ or ▶ button to align focus around the optical axis.

- * The picture shows an example when the lens shift is moved upward. Adjust the lens until the bottom edge of the projection screen is in focus.

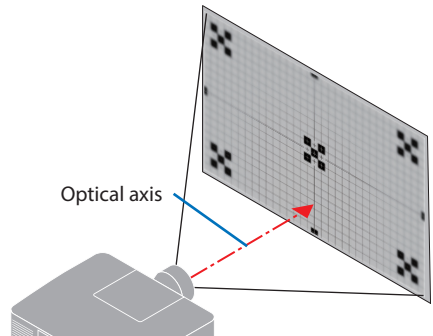
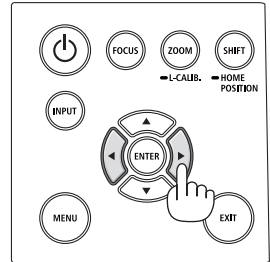
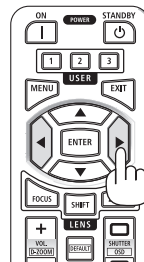
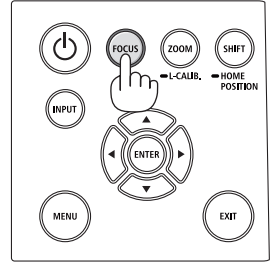
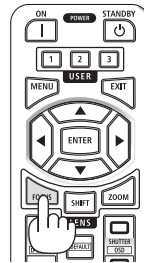

2. Projecting an Image (Basic Operation)

3. Press **▼** button to select the [PERIPHERY] on the on-screen menu, and then press either **◀** or **▶** button to align the focus of screen peripheral area.



4. Repeat steps 2 and 3 until the entire projection screen is in focus.

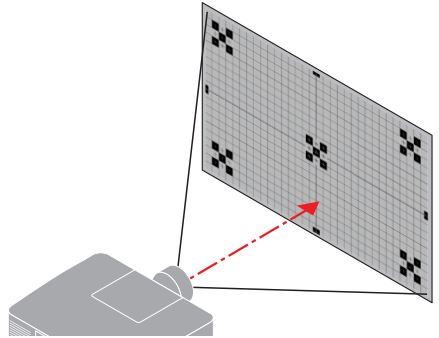

Applicable lens: NP54ZL/NP55ZL/NP56ZL

1. Press the FOCUS button.

The [LENS FOCUS] control screen will be displayed on.



Press **◀▶** buttons to adjust focus.

* [PERIPHERY] LENS FOCUS is not available for this lens unit.

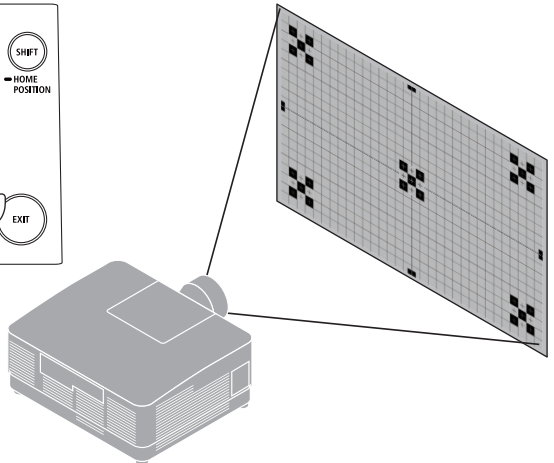
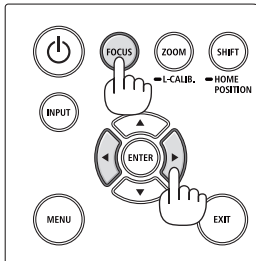
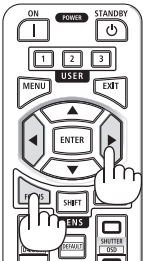

Zoom

1. Press ZOOM/L-CALIB. button.

The [ZOOM] adjustment screen will be displayed on.

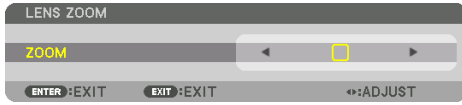

* In another way, press the ZOOM button on the remote control.

Press ◀▶ buttons to adjust zoom.

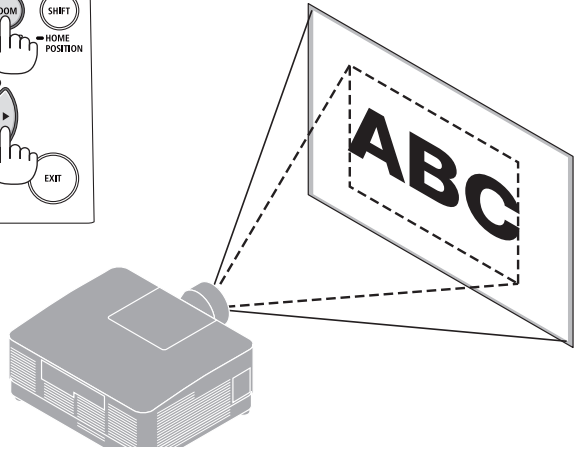
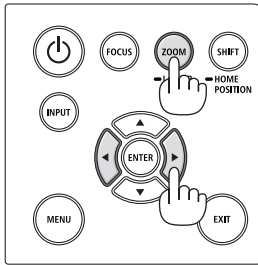
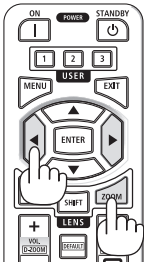

Adjusting the Tilt Foot

1. Turn the left and right tilt foot to adjust.

The tilt foot lengthen and shorten when turned. Turn one of the tilt foot to adjust the image so that it is level.

- The tilt foot can be lengthened by a maximum of 10 mm/0.4".
- The tilt foot can be used to tilt the projector by a maximum of 1.4°.

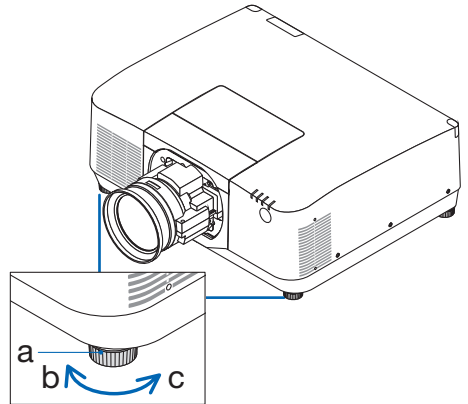
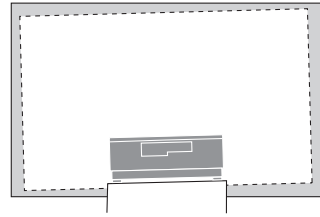

a: Tilt foot / b: Up / c: Down

NOTE:

- Do not lengthen the tilt foot any more than 10 mm/0.4". Doing so will make the projector unstable.
- Do not use the tilt foot for any purpose other than adjusting inclination of the projector installation angle. Handling the tilt foot improperly, such as carrying the projector by grasping the tilt foot or hooking it onto a wall using the tilt foot, could damage the projector.

2-6. Adjusting a picture and sound

Adjusting the picture

Display [ADJUST] in the on-screen menu and adjust the picture. Refer to the Installation Manual for details.

Turning Up or Down Volume

Sound level from the AUDIO OUT terminal can be adjusted.

Important:

- Do not turn up the volume to the maximum level on the external speaker system connected to the AUDIO OUT of the projector. Doing so may produce an unexpected, loud sound at the time of turning on or off the projector, causing damage to your hearing. When adjusting the volume on the external speaker system, set volume level of the speaker system to less than half its rating and adjust the volume on the projector to get appropriate sound level.

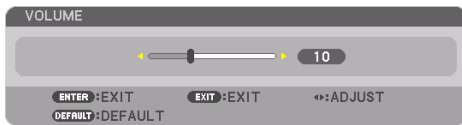

When no menus appear, the ◀ and ▶ buttons on the projector cabinet work as a volume control.

- On the remote control, press the VOL./D-ZOOM (+) or (-) button.

NOTE:

- The volume cannot be adjusted using the ◀ or ▶ button in the following cases.
 - When the on-screen menu is displayed
 - When the screen is enlarged by pressing the VOL./D-ZOOM (+) (-) buttons while holding down the CTL button on the remote control

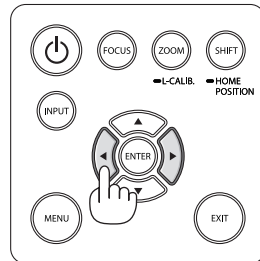
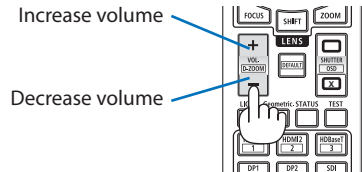



2-7. Turning off the Projector

To turn off the projector:

1. First, press the  (POWER) button on the projector cabinet or the STANDBY button on the remote control.

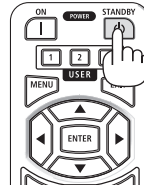
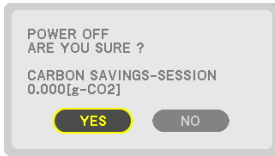
The [POWER OFF / ARE YOU SURE ? / CARBON SAVINGS-SESSION 0.000[g-CO2]] message will appear.



2. Secondly, press the ENTER button or press the  (POWER) or the STANDBY button again.

The light source will be turned off and the power supply will be cut.

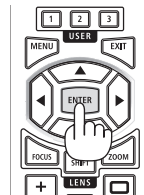

CAUTION

- Parts of the projector may become temporarily heated if the projector is turned off with the POWER button or if the AC power supply is disconnected during normal projector operation. Use caution when picking up the projector.

NOTE:

- While the POWER indicator is blinking blue in short cycles, the power cannot be turned off.
- Do not unplug the power cord from the projector or from the power outlet while an image is being projected. Doing so could deteriorate the projector's AC IN terminal or the power plug's contact. To turn off the AC power while an image is being projected, use the breaker, etc.
- Do not disconnect the AC power supply to the projector within 10 seconds of making adjustment or setting changes and closing the menu. Doing so can cause loss of adjustments and settings.

2-8. After Use

1. Unplug the power cord.

- ① Pull to an appropriate position while pushing down the knob of the power cord stopper.
- ② Press down the knob on the clamber to open the clamber and take out the power cord.

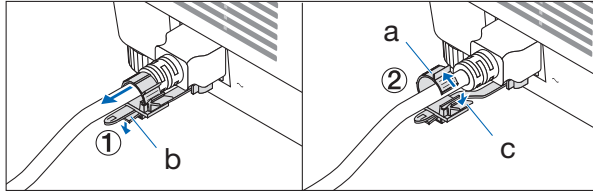

a: Clamber / b: Knob (power cord stopper) / c: Knob (clamber)

2. Disconnect any other cables.

3. Mount the lens cap on the lens.

4. Before moving the projector, screw in the tilt foot if they have been lengthened.

3. Appendix

3-1. Specifications

Model name		PA1705UL-W/PA1705UL-B	PA1505UL-W/PA1505UL-B
Method		Three primary color liquid crystal shutter projection method	
Specifications of main parts			
Liquid crystal panel	Size	1.0" × 3 (aspect ratio: 16:10)	
	Pixels ^(*)	2,304,000 (1920 dots × 1200 lines)	
Projection lenses	Refer to the specifications of option lens (→ 39 page)		
	Zoom	Motorized	
	Focus	Motorized	
	Lens shifting	Motorized	
Light source		Laser diode with Phosphor	
Optical device		Optical isolation by dichroic mirror, combining by dichroic prism	
Light output ^(*)		16000 lm ^(*) 17000 lm (Center)	14000 lm ^(*) 15000 lm (Center)
Screen size (throw distance)		60"–500" (Throw distance depends on the lens)	
Color reproducibility		10-bit color processing (approx. 1.07 billion colors)	
Scanning frequency	Horizontal	15 kHz, 24 to 153 kHz	
	Vertical	24, 25, 30, 48 Hz, 50 to 85 Hz, 100, 120 Hz	
Input/output connectors			
HDMI IN 1/2	Video input	Type A × 2 Deep Color, LipSync, HDCP ^(*) , 4K	
	Audio input	Sampling frequency: 32/44.1/48 kHz Sampling bits: 16/20/24 bit	
HDBaseT IN	Video input	RJ-45 x1, Deep Color, LipSync, HDCP ^(*) , 4K	
	Audio input	Sampling frequency: 32/44.1/48 kHz Sampling bits: 16/20/24 bit	
	Control	100BASE-TX, Art-Net, PLink class2	
HDBaseT OUT	Video output	RJ-45 x1, Deep Color, LipSync, HDCP ^(*) , 4K	
	Audio output	Sampling frequency: 32/44.1/48 kHz Sampling bits: 16/20/24 bit	
	Control	100BASE-TX, Art-Net, PLink class2	
SDI IN	Video input	BNC x1 3G/HD/SD	
	Audio input	2ch Stereo Audio Audio Channel1 : L ch Audio Channel2 : R ch Sampling frequency : 48kHz	
AUDIO OUT		Stereo mini jack × 1 (Common to all signals)	
USB		USB type A × 1, 5.0 V/1.4 A power supply	
Control Terminals	LAN	RJ-45 × 1, 10BASE-T/100BASE-TX, Art-Net, PLink class2	
	PC CONTROL	D-Sub 9-pin × 1, RS232C	
	REMOTE	Stereo mini jack × 1	
Built-in Speaker		Not applicable	

Model name		PA1705UL-W/PA1705UL-B	PA1505UL-W/PA1505UL-B
Usage environment ^(*5)		Operating temperature: 32 to 113°F (0 to 45°C)	
		Operating humidity: 20 to 80% (with no condensation)	
		Storage temperature: 14 to 122°F (-10 to 50°C)	
		Storage humidity: 20 to 80% (with no condensation)	
		Operating altitude: 0 to 3650 m/12000 feet	
Power supply		100-240 V AC, 50/60 Hz	
Power consumption		1035 W (100-130 V AC) 995 W (200-240 V AC)	960 W (100-130 V AC) 925 W (200-240 V AC)
Power consumption (Standby state)	Network enabled	0.4 W (100-130 V AC) / 0.5 W (200-240 V AC)	
	Network disabled	0.15 W (100-130 V AC) / 0.20 W (200-240 V AC)	
Rated input current		12.8 A (100-130 V AC) 5.6 A (200-240 V AC)	11.6 A (100-130 V AC) 5.1 A (200-240 V AC)
Power cord specification		15 A or higher	
External dimensions		23.6" (width) × 9.0" (height) × 19.3" (depth)/ 599 (width) × 230 (height) × 490 (depth) mm (not including protruding parts)	
		23.6" (width) × 9.4" (height) × 19.3" (depth)/ 599 (width) × 238 (height) × 490 (depth) mm (including protruding parts)	
Weight		63.3 lbs/28.7 kg (not including lens)	

*1 Effective pixels are more than 99.99%.

*2 This is the brightness when lens unit NP54ZL (sold separately) is attached and [REF. LIGHT MODE] is set to [NORMAL], [REF. LIGHT ADJUST] is set to [100], and [PRESET] is set to [HIGH-BRIGHT]. Using [LIGHT ADJUST] will reduce brightness. If any other mode is selected as the [PRESET] mode, the light output value may drop slightly.

*3 Compliance with ISO21118-2020

*4 If you are unable to view material via the HDMI input, this does not necessarily mean the projector is not functioning properly. With the implementation of HDCP, there may be cases in which certain content is protected with HDCP and might not be displayed due to the decision/intention of the HDCP community (Digital Content Protection, LLC).

Video: HDR, Deep Color, 8/10/12-bit, Lip Sync.

Audio: LPCM; up to 2 ch, sample rate 32/44.1/48 KHz, sample bit; 16/20/24-bit

HDMI: Supports HDCP 2.2/1.4

HDBaseT: Supports HDCP 2.2/1.4

*5 The projector's protection functions will activate depending on the temperature of the operating environment.

• For additional information visit:

US: <https://www.sharpnecdisplays.us>

Europe: <https://www.sharpnecdisplays.eu>

Global: <https://www.sharp-nec-displays.com/global/>

For information on our optional accessories, visit our website or see our brochure.

The specifications are subject to change without notice.

Option lens (sold separately)

NP51ZL	Throw ratio 0.53–0.65 : 1, F1.94–2.20, f=12.0-14.6 mm
NP52ZL	Throw ratio 0.65–0.87 : 1, F1.84–2.25, f=14.4-19.1 mm
NP53ZL	Throw ratio 0.86–1.25 : 1, F1.80–2.24, f=19.0-27.6 mm
NP54ZL	Throw ratio 1.24–2.01 : 1, F1.80–2.24, f=27.7-44.3 mm
NP55ZL	Throw ratio 1.98–3.95 : 1, F1.84–2.58, f=43.8-86.0 mm
NP56ZL	Throw ratio 3.95–7.51 : 1, F1.85-2.41, f=86.2-164.8 mm

NOTE:

- The above throw ratio is for projecting on 100" screen.
- The NP51ZL and NP56ZL will be marketed sequentially after June 2024.

Function Lens model name	Motorized lens shift	Motorized zoom	Motorized focus		LENS CALIBRATION	Home position	REF. LENS MEMORY
			CENTER	PERIPHERY			LENS MEMORY
NP51ZL	Yes	Yes	Yes	Yes	Yes	Yes	Yes
NP52ZL	Yes	Yes	Yes	Yes	Yes	Yes	Yes
NP53ZL	Yes	Yes	Yes	Yes	Yes	Yes	Yes
NP54ZL	Yes	Yes	Yes	No	Yes *	Yes	Yes *
NP55ZL	Yes	Yes	Yes	No	Yes *	Yes	Yes *
NP56ZL	Yes	Yes	Yes	No	Yes *	Yes	Yes *

* Except [PERIPHERY] focus

3-2. Troubleshooting





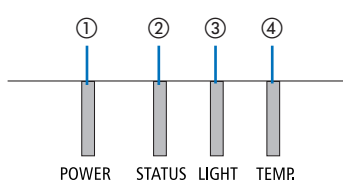



























This section helps you resolve problems you may encounter while setting up or using the projector.



















Feature of each indicator



- ① POWER indicator
- ② STATUS indicator
- ③ LIGHT indicator
- ④ TEMP. indicator

Indicator Message (Status message)

POWER	STATUS	LIGHT	TEMP.	Projector status
 Off	 Off	 Off	 Off	Power is off
 Orange (Blink ^{*1})	 Off	 Off	 Off	In the state of Standby ([POWER-SAVING] is [ON] and the network is ready).
 Orange (Blink ^{*2})	 Off	 Off	 Off	In the state of Standby ([POWER-SAVING] is [ON] and the network is unavailable).
 Orange (Light)	 Off	 Off	 Off	In the state of Standby ([POWER-SAVING] is [ON] and the network is available)
 Orange (Blink ^{*3})	 Off	 Off	 Off	[ON] time as the [PROGRAM TIMER] is activated. (In the state of Standby)
 Green (Light)	 Off	 Off	 Off	In the state of Sleep
 Green (Blink ^{*3})	 Off	 Off	 Off	[ON] time as the [PROGRAM TIMER] is activated. (In the state of Sleep)
 Blue (Light)	 Off	 Green (Light)	 Off	Powered state ([REF. LIGHT MODE] is [NORMAL])

POWER	STATUS	LIGHT	TEMP.	Projector status
 Blue (Light)	 Off	 Green (Blink* ³)	 Off	Powered state ([REF. LIGHT MODE] is [SILENT] or [LONG LIFE])
Status varies	 Orange (Blink* ⁴)	Status varies	 Off	[LENS CALIBRATION] implement request.
 Blue (Light)	 Green (Blink* ⁴)	Status varies	 Off	Performing the lens calibration
 Blue (Light)	Status varies	 Off	 Off	Shutter function is activating
 Blue (Blink* ³)	 Off	Status varies	 Off	[OFF TIMER] is activated, [OFF] time as the [PROGRAM TIMER] is activated (Powered state)
 Blue (Blink* ⁵)	 Off	 Off	 Off	Preparing for powering [ON]

*1 Repetition to light on for 1.5 seconds / off for 1.5 seconds





















*2 Repetition to light on for 1.5 seconds / off for 7.5 seconds

*3 Repetition to light on for 2.5 seconds / off for 0.5 seconds

*4 Repetition to light on for 0.5 seconds / off for 0.5 seconds / on for 0.5 seconds / off for 2.5 seconds

*5 Repetition to light on for 0.5 seconds / off for 0.5 seconds

Indicator Message (Error message)

POWER	STATUS	LIGHT	TEMP.	Projector status	Procedure
 Blue (Light)	 Orange (Light)	Status varies	 Off	A button has been pressed while the [CONTROL PANEL LOCK] is activated.	The [CONTROL PANEL LOCK] is activated. The setting must be canceled to operate the projector.
				ID numbers for the projector and the remote control do not match.	Check the [CONTROL ID]
 Blue (Light)	 Off	 Orange (Light)	 Orange (Light)	Temperature problem	Ambient temperature is high. The projector's protection functions will activate depending on the temperature of the operating environment. Lower the room temperature.
 Red (Blink ^{*5})	 Off	 Off	 Off	Temperature problem	Ambient temperature is out of the operation temperature. Check if any obstruction stays near the exhaust vent.
 Red (Blink ^{*5})	 Red (Light)	 Red (Light)	 Off	Lens mounting error	Lens is not mounted properly. Mount it.
 Blue (Light)	Status varies	 Orange (Blink ^{*3}) or (Blink ^{*5})	Status varies	Error requiring service support	Although the projector can still be used, we recommend that you contact your dealer or service personnel and request an inspection.
		 Red (Light)			
 Red (Light)	Status varies	Status varies	 Off	Error requiring service support	Contact your dealer or service personnel. Make sure to check and inform indicator status for asking to repair.

*3 Repetition to light on for 2.5 seconds / off for 0.5 seconds

*5 Repetition to light on for 0.5 seconds / off for 0.5 seconds

When the thermal protector is activated:

When inside temperature of the projector becomes too high or low, the POWER indicator start to red blink in a short cycle. After this happened, the thermal protector will activate and the projector may be turned off.

In this case, please take the below measures:

- Pull out the power plug from the wall inlet.
- Place the projector in cool place if it has been placed in high ambient temperature.
- Clean the exhaust vent if dust has accumulated on.
- Leave the projector for about one hour until inside temperature gets lower.

Common Problems & Solutions

Problem	Check These Items
Does not turn on or shut down	<ul style="list-style-type: none"> • Check that the power cord is plugged in and that the power button on the projector cabinet or the remote control is on. • Check to see if the projector has temperature error, If projector inside temperature is too hot or cool, it disabled to turn on the projector as the protection. Wait for a moment and try turn on the projector again. • In case it's hard to think the trouble is not caused on the above mentioned conditions, unplug the power cord from the outlet. Then wait 5 minutes before plugging it in again.
Will turn off	<ul style="list-style-type: none"> • Ensure that the [OFF TIMER], [AUTO POWER OFF] or [PROGRAM TIMER] is off.
No picture	<ul style="list-style-type: none"> • Check if the appropriate input is selected. If there is still no picture, press the INPUT button or one of the input buttons again. • Ensure your cables are connected properly. • Use menus to adjust the brightness and contrast. • Is the [POWER ON SHUTTER] in the on-screen menu set to [CLOSE]? • Check that the SHUTTER CLOSE button is not pressed. • Reset the settings or adjustments to factory preset levels using the [RESET] in the Menu. • Enter your registered keyword if the Security function is enabled. • If the HDMI input signal cannot be displayed, try the following. Reinstall your driver for the graphics card built in your computer, or use the updated driver. For reinstalling or updating your driver, refer to the user guide accompanied with your computer or graphics card, or contact the support center for your computer manufacturer. Install the updated driver or OS on your own responsibility. We are not liable for any trouble and failure caused by this installation. • The signal may not be supported depending on the HDBaseT transmission device. In addition, RS232C interface may not be supported. • If the projector is kept in sleep mode or other similar state, the temperature of the internal components could rise even when the projector is being used within its normal operating temperate. If the power is ON when that occurs, the cooling fan will turn on and it will take a little bit of time before the image is projected. Please wait for a while.
Picture suddenly becomes dark	<ul style="list-style-type: none"> • A hot room may trigger the projector's protection functions, which can result in a temporary reduction in luminance (brightness). Reduce the temperature in the room.
Color tone or hue is unusual	<ul style="list-style-type: none"> • Check if an appropriate color is selected in [WALL COLOR]. If so, select an appropriate option. • Adjust [HUE] in [PICTURE].
Image isn't square to the screen	<ul style="list-style-type: none"> • Reposition the projector to improve its angle to the screen. • Perform [GEOMETRIC CORRECTION] when the trapezoid is distorted.
Picture is blurred	<ul style="list-style-type: none"> • Adjust the focus. • Reposition the projector to improve its angle to the screen. • Ensure that the distance between the projector and screen is within the adjustment range of the lens. • Has the lens been shifted by an amount exceeding the guaranteed range? • Condensation may form on the lens if the projector is cold, brought into a warm place and is then turned on. Should this happen, let the projector stand until there is no condensation on the lens.

Problem	Check These Items
Image is scrolling vertically, horizontally or both	<ul style="list-style-type: none"> • Check the computer's resolution and frequency. Make sure that the resolution you are trying to display is supported by the projector. • Adjust the computer image manually with the Horizontal/Vertical in the [IMAGE OPTIONS].
Remote control does not work	<ul style="list-style-type: none"> • Aim the remote control's infrared transmitter towards the projector's remote control receiver. • Install new batteries. • Make sure there are no obstacles between you and the projector. • Stand within 20 m/787 inch of the projector. • If a [CONTROL ID] has been set, check whether the ID number for the remote control matches the ID number for the projector.
On-screen menu is not displayed	<ul style="list-style-type: none"> • Check whether On-screen mute is active. On-screen mute can be turned off using one of the following ways: <ul style="list-style-type: none"> - Press the OSD OPEN button while holding down the CTL button on the remote control. - Holding down the MENU button on the projector cabinet for at least 10 seconds.
Indicator is lit or blinking	<ul style="list-style-type: none"> • See the Indicator Message.

For more information contact your dealer.

3-3. Mounting a lens (sold separately)

Six separate bayonet style lenses can be used with this projector. The descriptions here are for the NP54ZL lens. Mount other lenses in the same manner.

After installing or replacing the lens unit, press the ZOOM/L-CALIB. button on the projector to carry out [LENS CALIBRATION]. By carrying out [LENS CALIBRATION], the adjustment range of the lens shift is calibrated.

WARNING:

(1) Turn off the power and wait for the cooling fan to stop, (2) disconnect the power cord and wait for the unit to cool before mounting or removing the lens. Failure to do so can result in eye injury, electric shock, or burn injuries.

Important:

- The projector and lenses are made of precision parts. Do not subject them to shock or excessive forces.
- Remove the separately sold lens when moving the projector. If not, the lens could be subject to shock while the projector is being moved, damaging the lens and the lens shift mechanism.
- If the projector must be moved with the lens unit attached, such as when it is installed in a high or specific location, use the screws included with the lens unit to secure it to the projector. Do not hold the lens when moving the projector.
- When dismantling the lens from the projector, return the lens position to the home position before turning off the power. Failure to do so may prevent the lens from being mounted or dismantled because of narrow space between the projector and the lens.
- Never touch the lens surface while the projector is operating.
- Be very careful not to let dirt, grease, etc., on the lens surface and not to scratch the lens surface.
- Perform these operations on a flat surface over a piece of cloth, etc., to prevent the lens from getting scratched.
- When leaving the lens off the projector for long periods of time, mount the dust cap on the projector to prevent dust or dirt from getting inside.

Mounting

1. Remove the dust cap from the projector.

Pull on the bottom edge of the dust cap with your fingers.

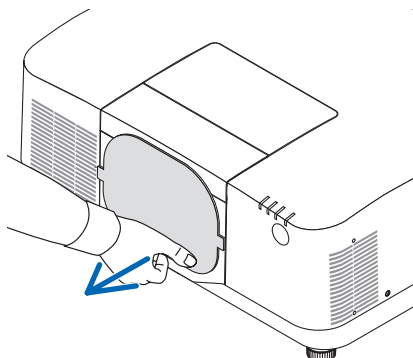

2. Remove the lens cap on the back of the lens.

NOTE:

- Make sure to remove the lens cap at the unit back side. If the lens unit with the lens cap remaining on is installed on the projector, it may cause of malfunction.

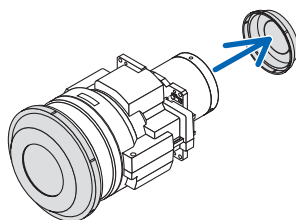
**3. Remove the lens cover.**

Pull the cover about 2 cm forward, then lift it up.

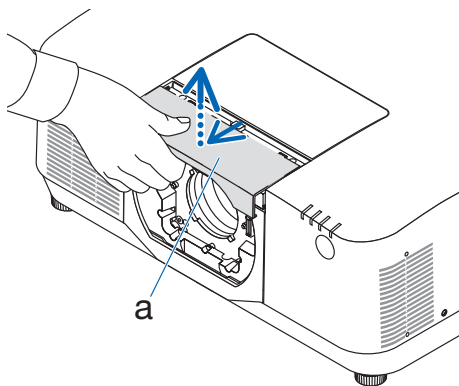

a: Lens cover

4. Check that the lens lock lever is in the UNLOCK position.

If it is in the LOCK position, press the right side of the lens lock lever to move it to the UNLOCK position.

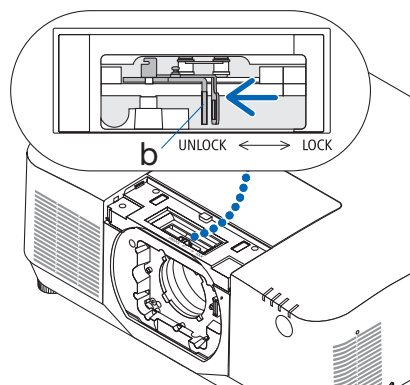

b: Lens lock lever

5. With the plate on the lens unit facing up, insert the lens unit into the projector's lens hole.

Align the position of the connector and gently insert it as far back as possible.

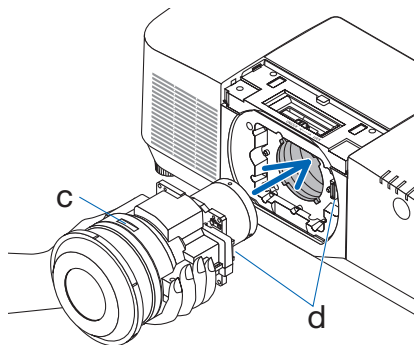

c: Plate / d: Connector

6. While supporting the lens unit with your hand, press the left side of the lens lock lever towards the LOCK position until it stops.

A clicking sound will confirm that the lens unit is attached to the projector body.

The left and right parts of the lens lock lever will open when the lens unit is attached correctly.

NOTE:

- The lens unit will not lock in place if it is tilted. Move the lens lock lever while the lens unit is still attached to the lens hole.

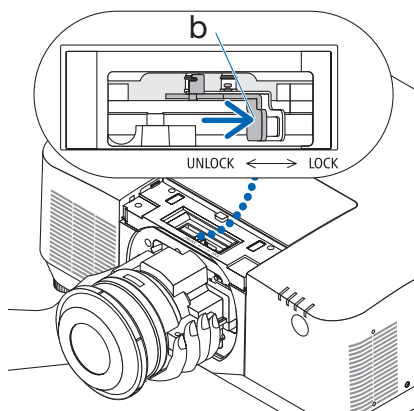

b: Lens lock lever

7. Attach the lens cover to the projector.

- (1) Leave a gap of about 2 cm when attaching the lens cover.
- (2) Push it in the direction of the arrow.

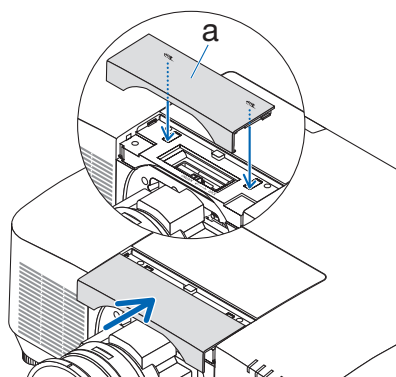

a: Lens cover

Removing

Preparations:

1. Turn on the projector and display an image.
2. Press and hold the SHIFT/HOME POSITION button over 2 seconds. The lens position will be moved to the home position.
3. Turn off the main power switch, and then unplug the power cord.
4. Mount the lens cap on the lens.
5. Wait until the projector cabinet is cool enough to handle.

1. Remove the lens cover.

Pull the cover about 2 cm forward, then lift it up.

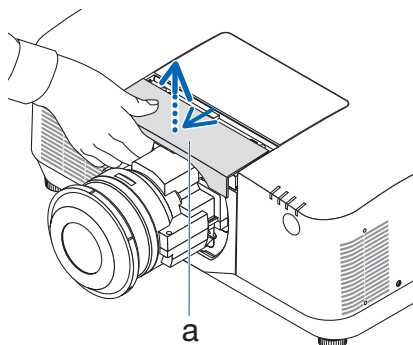

a: Lens cover

2. While supporting the lens unit with one hand, press the right side of the lens lock lever towards the UNLOCK position until it stops.

NOTE:

- Hold the lens unit securely to prevent it from falling.

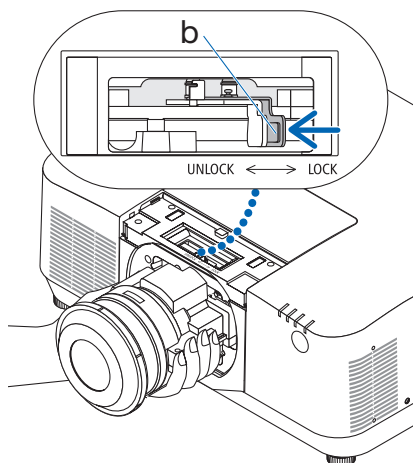

b: Lens lock lever

3. Gently pull the lens unit out from the projector.

Once the lens unit has been removed, attach the rear lens cap included with the lens unit before storing.

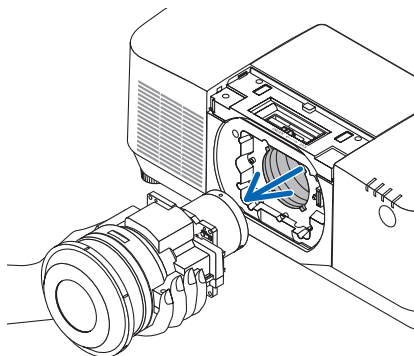
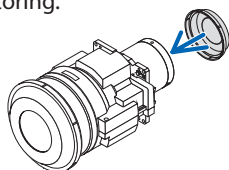

4. Attach the lens cover to the projector.

- (1) Leave a gap of about 2 cm when attaching the lens cover.
- (2) Push it in the direction of the arrow.

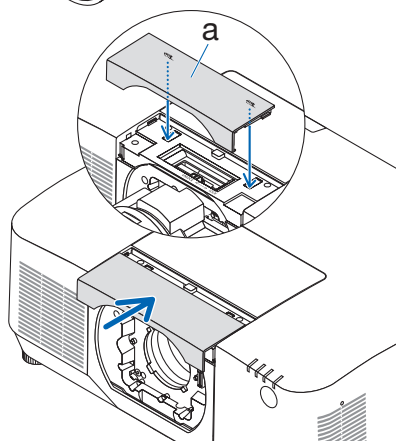

a: Lens cover

* When not attaching a lens unit, attach the dust cap supplied with the projector.

Align the dust cap with the projector body, place the lower section on the projector, then push the surrounding area.

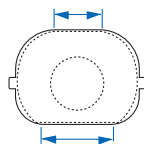

The bottom side of the dust cover is the side with the longer flat area.

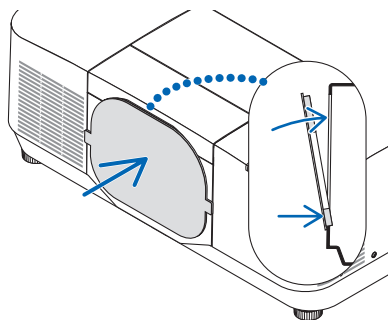

REGISTER YOUR PROJECTOR! (for residents in the United States, Canada, and Mexico)

Please take time to register your new projector. This will activate your limited parts and labor warranty and InstaCare service program.

Visit our web site at <https://www.sharpnecdisplays.us>, click on support center/register product and submit your completed form online.

Upon receipt, we will send a confirmation letter with all the details you will need to take advantage of fast, reliable warranty and service programs from the industry leader, Sharp NEC Display Solutions of America, Inc.