



Digital Projector User Manual

Warranty and Copyright information

Limited warranty

BenQ warrants this product against any defects in material and workmanship, under normal usage and storage.

Proof of purchase date will be required with any warranty claim. In the event this product is found to be defective within the warranty period, BenQ's only obligation and your exclusive remedy shall be replacement of any defective parts (labor included). To obtain warranty service, immediately notify the dealer from which you purchased the product of any defects.

Important: The above warranty shall be void if the customer fails to operate the product in accordance with BenQ's written instructions, especially the ambient humidity must be in-between 10% and 90%, temperature in-between 0°C and 35°C, altitude lower than 4920 feet, and avoiding to operate the projector in a dusty environment. This warranty gives you specific legal rights, and you may have other rights which vary from country to country.

For other information, please visit www.BenQ.com.

Copyright

Copyright © 2024 by BenQ Corporation. All rights reserved. No part of this publication may be reproduced, transmitted, transcribed, stored in a retrieval system or translated into any language or computer language, in any form or by any means, electronic, mechanical, magnetic, optical, chemical, manual or otherwise, without the prior written permission of BenQ Corporation.

Disclaimer

BenQ Corporation makes no representations or warranties, either expressed or implied, with respect to the contents hereof and specifically disclaims any warranties, merchantability or fitness for any particular purpose. Further, BenQ Corporation reserves the right to revise this publication and to make changes from time to time in the contents hereof without obligation to notify any person of such revision or changes.

*DLP, Digital Micromirror Device and DMD are trademarks of Texas Instruments. Others are copyrights of their respective companies or organizations.

The terms HDMI, HDMI High-Definition Multimedia Interface, HDMI Trade dress and the HDMI Logos are trademarks or registered trademarks of HDMI Licensing Administrator, Inc.

Table of Contents

Warranty and Copyright information	2
Important safety instructions	4
Introduction	7
Shipping contents	7
Projector exterior view	8
Controls and functions.....	9
Positioning your projector	11
Choosing a location	11
Obtaining a preferred projected image size.....	12
Mounting the projector	13
Adjusting the projected image	14
Connection	16
Operation	18
Installing the QS01 HDMI Media Streaming (Optional)	18
Starting up the projector	18
Setting up the QS01 HDMI Media Streaming (Optional).....	21
Using the menus	23
Securing the projector	24
Switching input signal	25
Shutting down the projector	26
Menu operation	27
Menu System	27
Maintenance	44
Care of the projector	44
Light source information	45
Troubleshooting	49
Specifications	50
Projector specifications	50
Dimensions	51
Timing chart.....	52
RS232 command.....	54

Important safety instructions

Your projector is designed and tested to meet the latest standards for safety of information technology equipment. However, to ensure safe use of this product, it is important that you follow the instructions mentioned in this manual and marked on the product.

1. **Please read this manual before you operate your projector.** Save it for future reference.

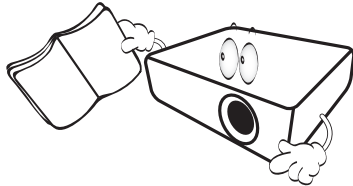

2. **Do not look straight at the projector lens during operation.** The intense light beam may damage your eyes.

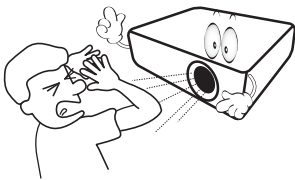

3. **Refer servicing to qualified service personnel.**

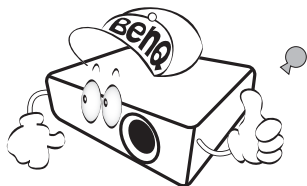

4. **Always open the lens shutter (if any) or remove the lens cap (if any) when the projector light source is on.**

5. The light source becomes extremely hot during operation. Allow the projector to cool for approximately 45 minutes prior to removing the light source assembly for replacement.

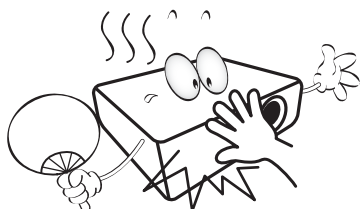

6. In some countries, the line voltage is NOT stable. This projector is designed to operate safely within a mains voltage between 100 to 240 volts AC, but could fail if power cuts or surges of ± 10 volts occur. **In areas where the mains voltage may fluctuate or cut out, it is recommended that you connect your projector through a power stabilizer, surge protector or uninterruptible power supply (UPS).**

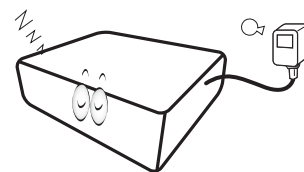

7. Do not block the projection lens with any objects when the projector is under operation as this could cause the objects to become heated and deformed or even cause a fire. To temporarily turn off the light source, press the **ECO BLANK** button.

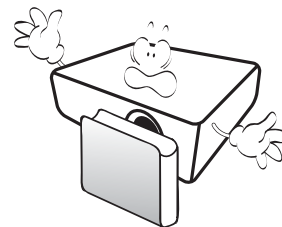

8. Do not operate light sources beyond the rated life. Excessive operation of light sources beyond the rated life could cause them to break on rare occasions.

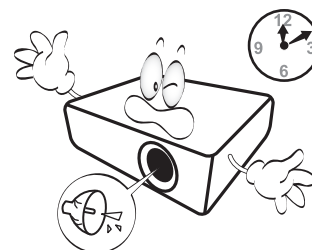

9. Never replace the light source assembly or any electronic components unless the projector is unplugged.

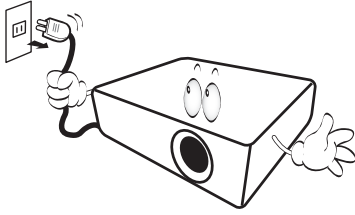

10. Do not place this product on an unstable cart, stand, or table. The product may fall, sustaining serious damage.

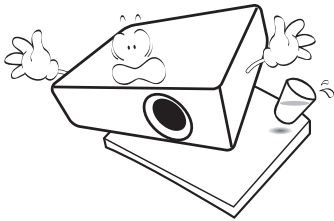

11. Do not attempt to disassemble this projector. There are dangerous high voltages inside which may cause death if you should come into contact with live parts. The only user serviceable part is the lamp which has its own removable cover.

Under no circumstances should you ever undo or remove any other covers. Refer servicing only to suitably qualified professional service personnel.

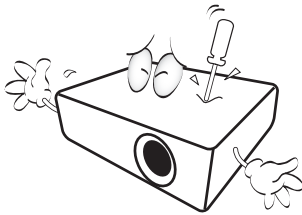

12. Do not block the ventilation holes.

- Do not place this projector on a blanket, bedding or any other soft surface.
- Do not cover this projector with a cloth or any other item.
- Do not place inflammables near the projector.

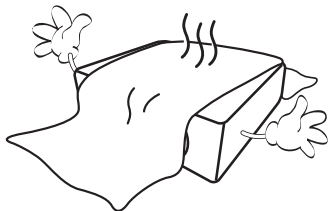

If the ventilation holes are seriously obstructed, overheating inside the projector may result in a fire.

13. Always place the projector on a level, horizontal surface during operation.

- Do not use if tilted at an angle of more than 10 degrees left to right, nor at angle of more than 15 degrees front to back. Using the projector when it is not fully horizontal may cause a malfunction of, or damage to, the light source.

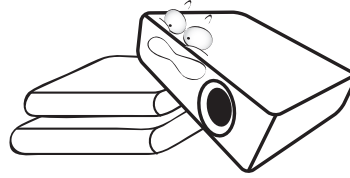

14. Do not stand the projector on end vertically. Doing so may cause the projector to fall over, causing injury or resulting in damage to the projector.

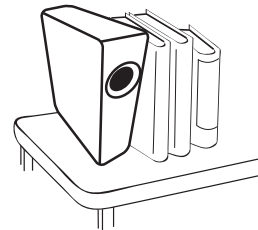

15. Do not step on the projector or place any objects upon it. Besides probable physical damage to the projector, doing so may result in accidents and possible injury.

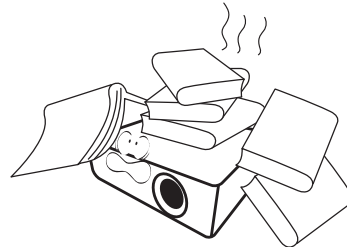

16. When the projector is under operation, you may sense some heated air and odor from its ventilation grill. It is a normal phenomenon and not a product defect.

17. Do not place liquids near or on the projector. Liquids spilled into the projector may cause it to fail. If the projector does become wet, disconnect it from the power supply's power outlet and call BenQ to have the projector serviced.

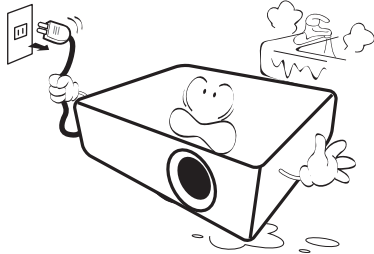

18. This product is capable of displaying inverted images for ceiling/wall mount installation.

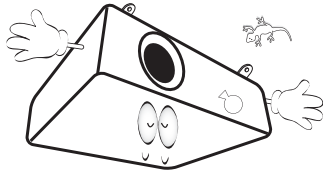

19. This apparatus must be earthed.

20. Do not place this projector in any of the following environments.

- Space that is poorly ventilated or confined. Allow at least 50 cm clearance from walls and free flow of air around the projector.
- Locations where temperatures may become excessively high, such as the inside of a car with all windows rolled up.
- Locations where excessive humidity, dust, or cigarette smoke may contaminate optical components, shorten the projector's life span and darken the image.

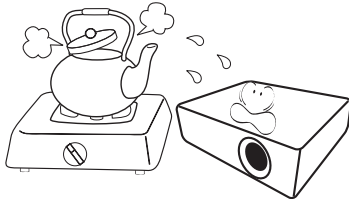

- Locations near fire alarms
- Locations with an ambient temperature above 40°C / 104°F
- Locations where the altitudes are higher than 3000 m (10000 feet).

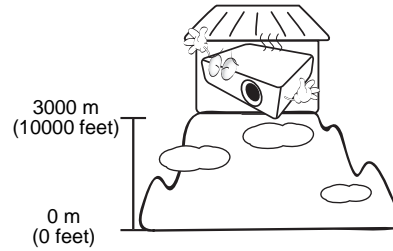

Risk Group 2

1. According to the classification of photobiological safety of light sources and light source systems, this product is Risk Group 2, IEC 62471-5:2015.
2. Possibly hazardous optical radiation emitted from this product.
3. Do not stare at operating light source. May be harmful to the eyes.
4. As with any bright source, do not stare into the direct beam.



! Hg - Lamp contains mercury. Manage in accordance with local disposal laws. See www.lamprecycle.org.

! To avoid damaging the DLP chips, never aim a high-power laser beam into the projection lens.

Introduction

Shipping contents

Carefully unpack and verify that you have all of the items shown below. If any of these items are missing, please contact your place of purchase.

Standard accessories

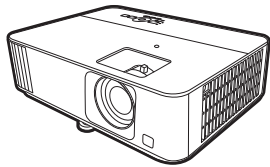

Projector

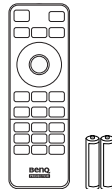

Remote control with batteries

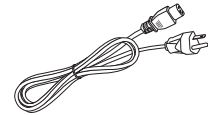

Power cord



Quick start guide



Regulatory statements



Warranty card*



- The supplied accessories will be suitable for your region, and may differ from those illustrated.
- *The warranty card is only supplied in some specific regions. Please consult your dealer for detailed information.

Optional accessories

1. Spare lamp kit
2. QS01 HDMI Media Streaming

Replacing the remote control batteries

1. Press and slide off the battery cover, as illustrated.
2. Remove the old batteries (if applicable) and install two AAA batteries. Make sure that the positive and negative ends are positioned correctly, as illustrated.
3. Slide the battery cover in until it clicks into place.

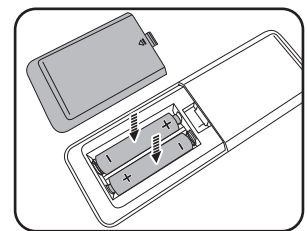
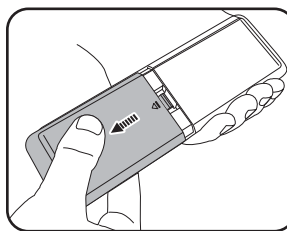

- Avoid leaving the remote control and batteries in an excessive heat or humid environment like the kitchen, bathroom, sauna, sunroom or in a closed car.
- Replace only with the same or equivalent type recommended by the battery manufacturer.
- Dispose of the used batteries according to the manufacturer's instructions and local environment regulations for your region.
- Never throw the batteries into a fire. There may be danger of an explosion.
- If the batteries are dead or if you will not be using the remote control for an extended period of time, remove the batteries to avoid damage to the remote control from possible battery leakage.

Projector exterior view

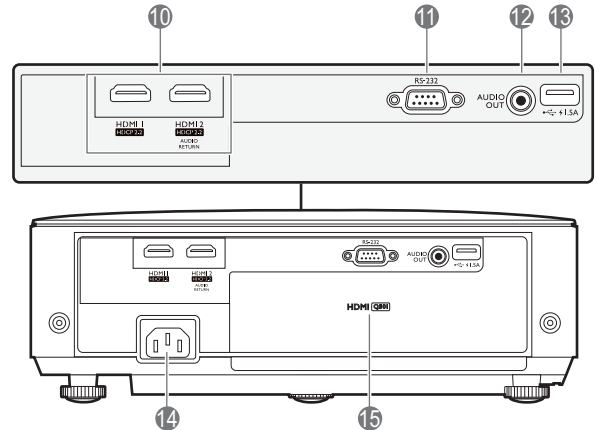
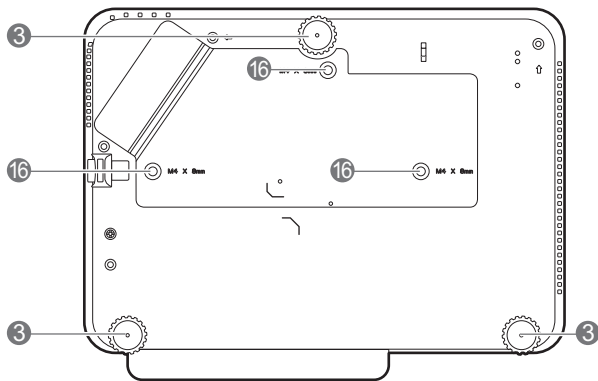
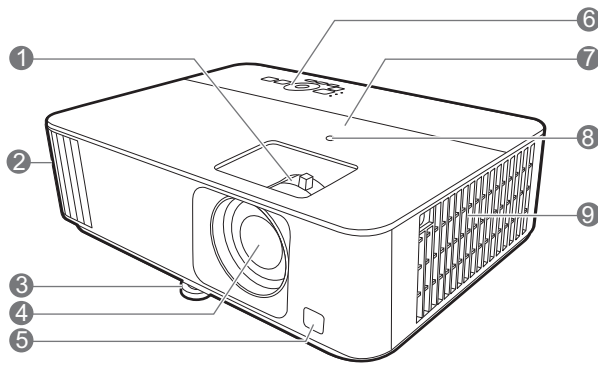

- 1. Focus ring and Zoom ring
- 2. Vent (air exhaust)
- 3. Adjuster feet
- 4. Projection lens
- 5. IR remote sensor
- 6. External control panel
(See [Controls and functions on page 9.](#))
- 7. Lamp cover
- 8. Ambient Light Sensor (ALS)
- 9. Vent (air inlet)
- 10. HDMI 1/HDMI 2 input port
- 11. RS-232 control port
- 12. Audio output jack
- 13. USB Type A port (Power supply 1.5 A)
- 14. AC power jack
- 15. QS01 HDMI Media Streaming port
(QS01 is an optional accessory.)
- 16. Ceiling mount holes

Controls and functions

Projector & Remote control



All the key presses described in this document are available on the remote control or projector.

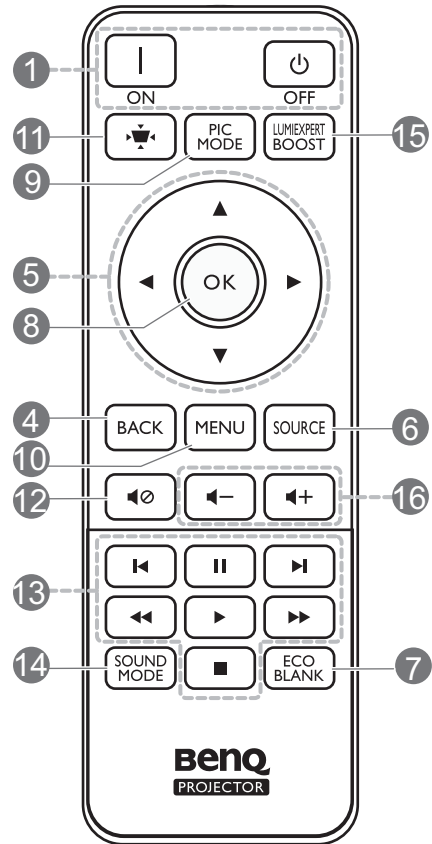
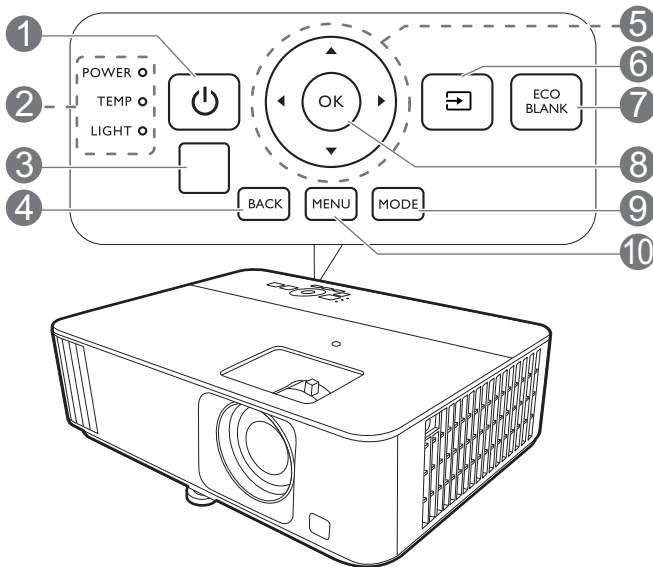

1. **POWER**

Toggles the projector between standby mode and on.

ON / **OFF**

Toggles the projector between standby mode and on.

2. **POWER indicator light/TEMPerature warning light/LIGHT indicator light** (See [Indicators on page 48.](#))

3. IR remote sensor

4. **BACK**

Goes back to previous OSD menu, exits and saves menu settings.

5. Arrow keys (, , ,)

When the On-Screen Display (OSD) or the ATV menu is activated, these keys are used as directional arrows to select the desired menu items and to make adjustments.

When OSD and ATV menu is inactive, workable under CEC-capable sources only.

6. / **SOURCE**

Displays the source selection bar.

7. **ECO BLANK**

Used to hide the screen picture.



Do not block the projection lens from projecting as this could cause the blocking object to become heated and deformed or even cause a fire.

8. **OK**

- Confirms the selected ATV or On-Screen Display (OSD) menu item.
- Under ATV media playback, plays or pauses a video or audio file.

9. **MODE/PIC MODE**

Selects an available picture mode.

10. **MENU**

Turns on/off the On-Screen Display (OSD) menu.

11. **KEYSTONE**

Displays the keystone menu. See [Correcting keystone on page 15](#) for details.

12. **MUTE**

Toggles projector audio between on and off.

13. HDMI CEC-compatible device control keys (Backward, Pause, Forward, Rewind, Play, Fast forward, Stop)

Controls video or audio playback for the CEC-compatible device.

14. **SOUND MODE**

Selects an available sound mode.

15. **LUMIEXPERT BOOST**

Displays the **LumiExpert** menu.

16. / Volume keys

Decreases or increases the projector volume.

Remote control effective range

The remote control must be held at an angle within 30 degrees perpendicular to the projector's IR remote control sensor(s) to function correctly. The distance between the remote control and the sensor(s) should not exceed 8 meters (~ 26 feet).

Make sure that there are no obstacles between the remote control and the IR sensor(s) on the projector that might obstruct the infra-red beam.

- Operating the projector from the front

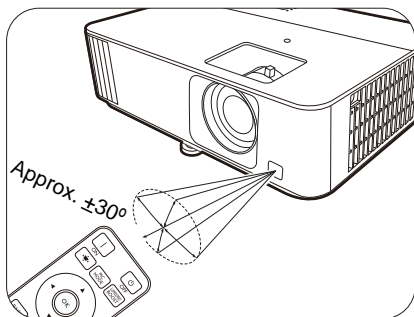

- Operating the projector from the top

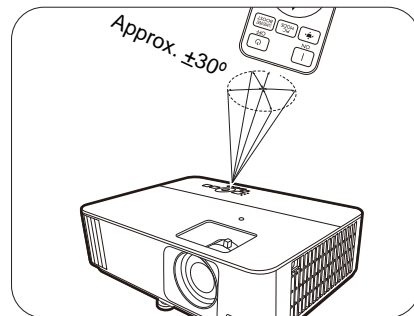

Positioning your projector

Choosing a location

Before choosing an installation location for your projector, take the following factors into consideration:

- Size and position of your screen
- Electrical outlet location
- Location and distance between the projector and the rest of your equipment

You can install your projector in the following ways.

1. Front

Select this location with the projector placed on the table in front of the screen. This is the most common way to position the projector for quick setup and portability.

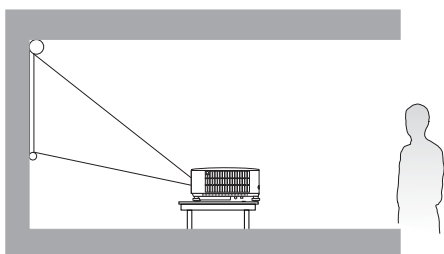

2. Rear

Select this location with the projector placed on the table behind the screen. Note that a special rear projection screen is required.

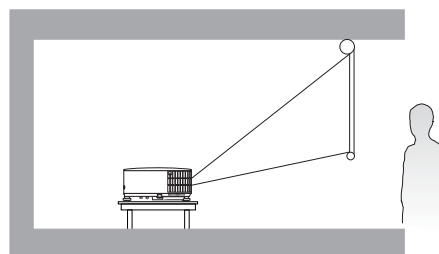

3. Front Ceiling

Select this location with the projector suspended upside-down from the ceiling in front of the screen. Purchase the BenQ Projector Ceiling Mount Kit from your dealer to mount your projector on the ceiling.

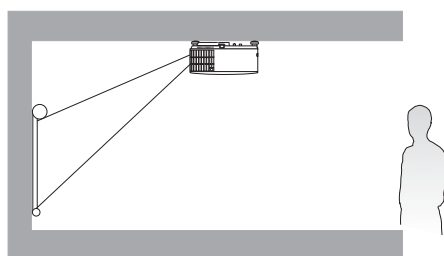

4. Rear Ceiling

Select this location with the projector suspended upside-down from the ceiling behind the screen. Note that a special rear projection screen and the BenQ Projector Ceiling Mount Kit are required for this installation location.

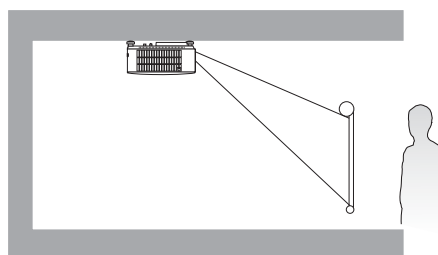

After turning on the projector, go to **Advanced** menu - **Installation** > **Projector Position**, press **OK** and press **◀/▶** to select a setting.

Obtaining a preferred projected image size

The distance from the projector lens to the screen, the zoom setting (if available), and the video format each factors in the projected image size.

Projection dimensions

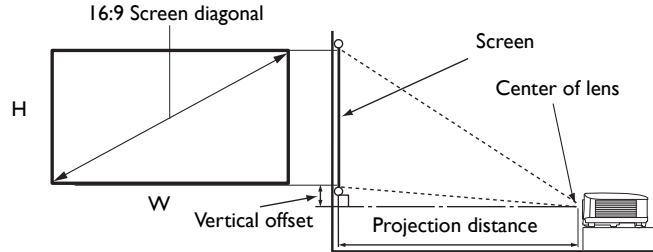

- The screen aspect ratio is 16:9 and the projected picture is in a 16:9 aspect ratio

Screen size			Projection distance (mm)			Vertical offset (mm)	
Diagonal		H (mm)	W (mm)	Min distance (with max zoom)	Average		Max distance (with min zoom)
Inch	mm						
30	762	374	664	748	859	970	37
40	1016	498	886	998	1145	1293	50
50	1270	623	1107	1247	1432	1616	62
60	1524	747	1328	1497	1718	1939	75
70	1778	872	1550	1746	2004	2263	87
80	2032	996	1771	1996	2291	2586	100
90	2286	1121	1992	2245	2577	2909	112
100	2540	1245	2214	2495	2864	3232	125
110	2794	1370	2435	2744	3150	3555	137
120	3048	1494	2657	2994	3436	3879	149
130	3302	1619	2878	3243	3723	4202	162
140	3556	1743	3099	3493	4009	4525	174
150	3810	1868	3321	3742	4295	4848	187
160	4064	1992	3542	3992	4582	5171	199
170	4318	2117	3763	4241	4868	5495	212
180	4572	2241	3985	4491	5154	5818	224
190	4826	2366	4206	4740	5441	6141	237
200	5080	2491	4428	4990	5727	6464	249
210	5334	2615	4649	5239	6013	6788	262
220	5588	2740	4870	5489	6300	7111	274
230	5842	2864	5092	5738	6586	7434	286
240	6096	2989	5313	5988	6873	7757	299
250	6350	3113	5535	6237	7159	8080	311
260	6604	3238	5756	6487	7445	8404	324
270	6858	3362	5977	6736	7732	8727	336
280	7112	3487	6199	6986	8018	9050	349
290	7366	3611	6420	7235	8304	9373	361
300	7620	3736	6641	7485	8591	9696	374

For example, if you are using a 120-inch screen, the recommended projection distance in the "Average" column is 3436 mm.

If your measured projection distance is 3700 mm, the closest match in the "Average" column is 3723 mm. Looking across this row shows that a 130" (about 3.3 m) screen is required.



To optimize your projection quality, we suggest doing the projection by referring to the values listed in the non-gray rows.



All measurements are approximate and may vary from the actual sizes.

BenQ recommends that if you intend to permanently install the projector, you should physically test the projection size and distance using the actual projector in situ before you permanently install it, so as to make allowance for this projector's optical characteristics. This will help you determine the exact mounting position so that it best suits your installation location.

Mounting the projector

If you intend to mount your projector, we strongly recommend that you use a proper fitting BenQ projector mounting kit and that you ensure it is securely and safely installed.

If you use a non-BenQ brand projector mounting kit, there is a safety risk that the projector may fall down due to an improper attachment through the use of the wrong gauge or length screws.

Before mounting the projector

- Purchase a BenQ projector mounting kit from the place you purchased your BenQ projector.
- Ask your dealer to install the projector for you. Installing the projector on your own may cause it to fall and result in injury.
- Take necessary procedures to prevent the projector from falling off such as during an earthquake.
- The warranty doesn't cover any product damage caused by mounting the projector with a non-BenQ brand projector mounting kit.
- Consider the surrounding temperature where the projector is ceiling/wall mounted. If a heater is used, the temperature around the ceiling may be higher than expected.
- Read the user manual for the mounting kit about the range of torque. Tightening with torque exceeding the recommended range may cause damage to the projector and subsequently falling off.
- Make sure the power outlet is at an accessible height so that you can easily shut down the projector.

Ceiling/Wall mount installation diagram

Ceiling/Wall mount screw hole: M4 x 8 mm

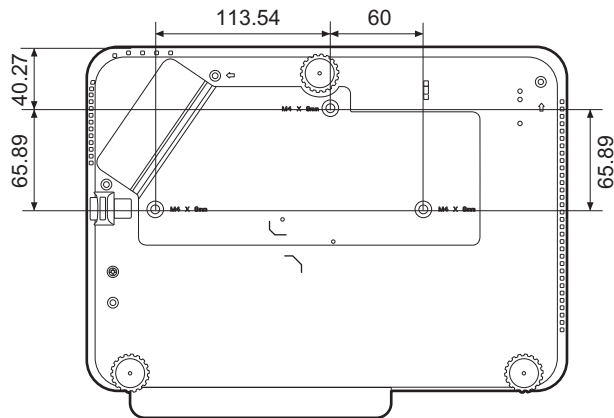

Unit: mm

Adjusting the projected image

Adjusting the projection angle

If the projector is not placed on a flat surface or the screen and the projector are not perpendicular to each other, the projected image becomes trapezoidal. You can adjust the adjuster feet to fine-tune the horizontal angle.

To retract the feet, screw the adjuster feet in a reverse direction.

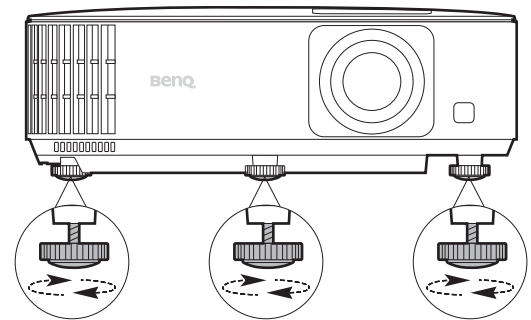

Do not look into the lens while the light source is on. The strong light from the light source may cause damage to your eyes.

Fine-tuning the image size and clarity

- Adjust the projected image to the size that you need using the zoom ring.
- Sharpen the image by rotating the focus ring.

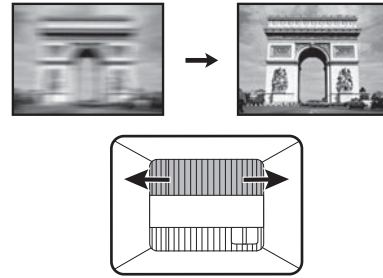
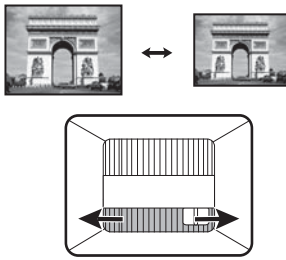

Correcting keystone

Keystoning refers to the situation where the projected image becomes a trapezoid due to angled projection.

To correct the distorted image:

1. Display the **2D Keystone** correction from the following menus.
 - The setup wizard during the projector initial setup
 - The **Basic** menu system
 - The **Installation** menu of the **Advanced** menu system
2. After the **2D Keystone** correction page appears:
 - To correct keystoning at the top of the image, use ▼.
 - To correct keystoning at the bottom of the image, use ▲.
 - To correct keystoning at the right side of the image, use ◀.
 - To correct keystoning at the left side of the image, use ▶.
 - To automatically correct the vertical sides of the distorted image, press **OK** for 2 seconds, or enable **Auto Vertical Keystone** in the **Advanced** menu - **Installation** menu.
3. When done, press ⏪ to save your changes and exit.

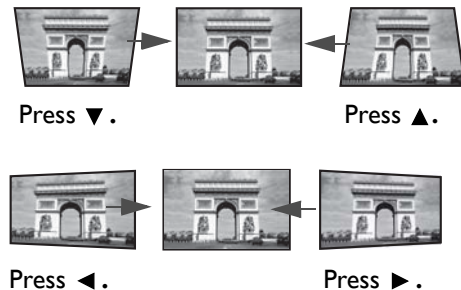

Connection

When connecting a signal source to the projector, be sure to:

1. Turn all equipment off before making any connections.
2. Use the correct signal cables for each source.
3. Ensure the cables are firmly inserted.

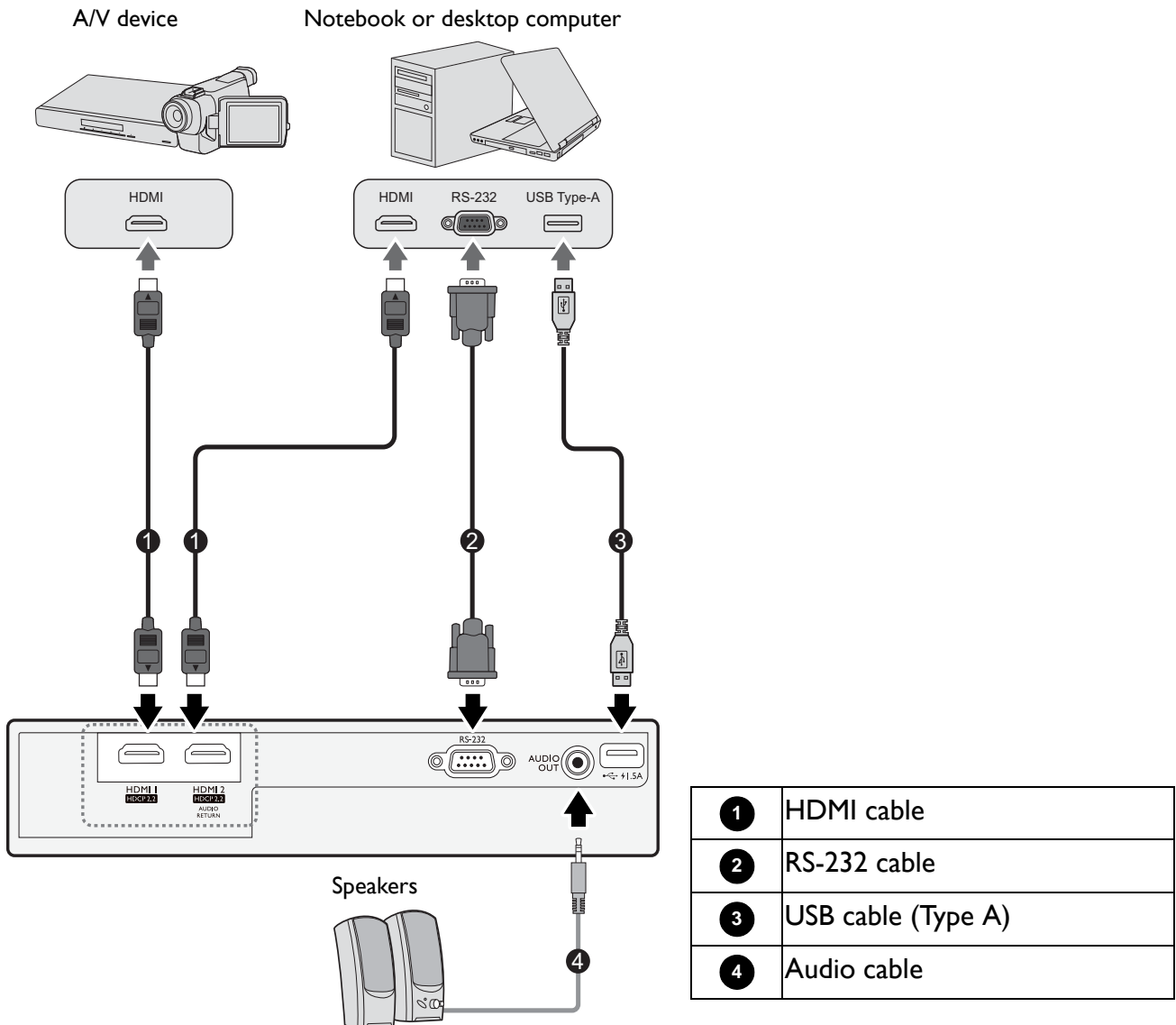

- In the connections above, some cables may not be included with the projector (see [Shipping contents on page 7](#)). They are commercially available from electronics stores.
- The connection illustrations are for reference only. The rear connecting jacks available on the projector vary with each projector model.
- Many notebooks do not turn on their external video ports when connected to a projector. Usually a key combo like FN + function key with a monitor symbol turns the external display on/off. Press FN and the labeled function key simultaneously. Refer to your notebook's documentation to find your notebook's key combination.
- If the selected video image is not displayed after the projector is turned on and the correct video source has been selected, check that the video source device is turned on and operating correctly. Also check that the signal cables have been connected correctly.

Connecting audio

The projector has built-in mono speaker(s) which are designed to provide basic audio functionality accompanying data presentations for business purposes only. They are not designed for, nor intended for stereo audio reproduction use as might be expected in home theater or home cinema applications. Any stereo audio input (if provided), is mixed into a common mono audio output through the projector speaker(s).

The built-in speaker(s) will be muted when the **AUDIO OUT** jack is connected.



- The projector is only capable of playing mixed mono audio, even if a stereo audio input is connected.

Operation



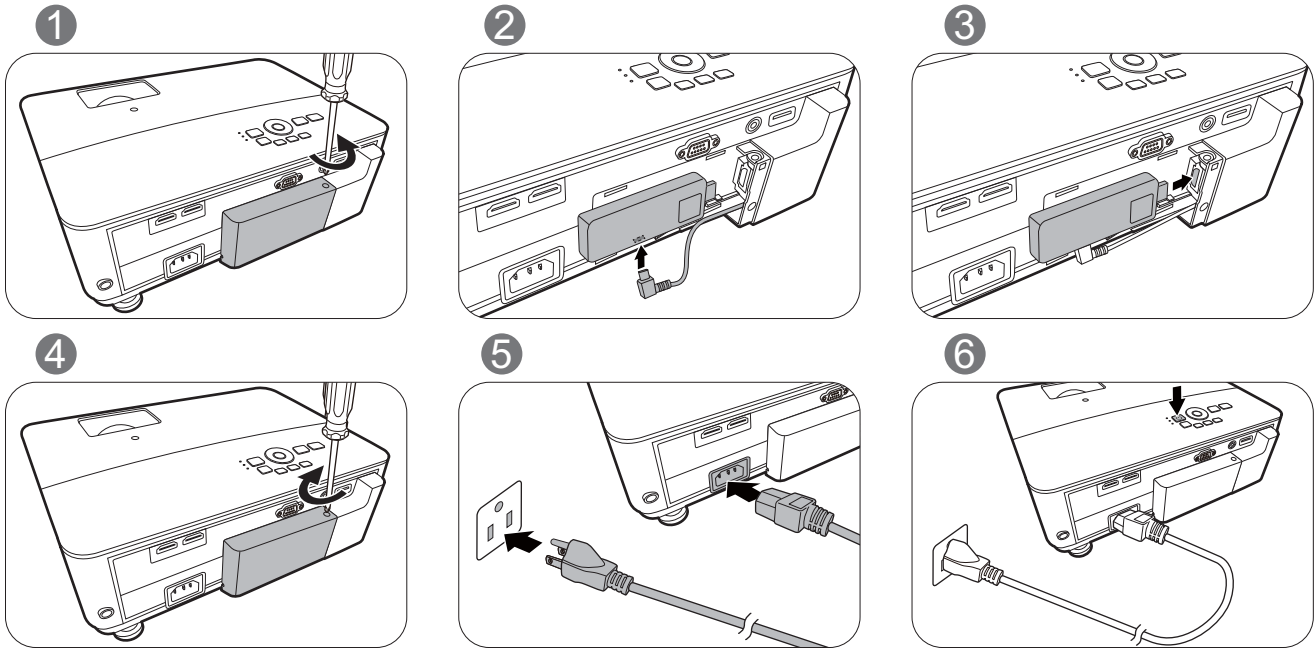

Installing the QS01 HDMI Media Streaming (Optional)

The QS01 HDMI Media Streaming is an Android TV (ATV) dongle to be used with the projector. For more information about this dongle, please contact the place you purchased this projector.

If you already have the dongle, see the illustrations below to install the dongle. Make sure that the dongle cover is installed back correctly after the dongle is plugged. Do not turn the power on with the dongle cover open.



Starting up the projector

1. Plug the power cord. Turn on the power outlet switch (where fitted). The power indicator on the projector lights orange after power has been applied.
2. Press  to start the projector. The power indicator flashes green and stays green when the projector is on. The start up procedure takes about 30 seconds. In the later stage of start up, a startup logo is projected. (If necessary) Rotate the focus ring to adjust the image clearness.
3. If this is the first time you turn on the projector, the setup wizard appears to guide you through setting up the projector. If you have already done this, skip this step and move on to the next step.
 - Use the arrow keys (/ / / ) on the projector or remote control to move through the menu items.
 - Use **OK** to confirm the selected menu item.

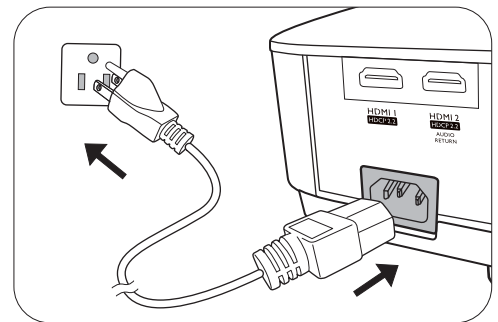

 The Setup Wizard screenshots below are for reference only and may differ from the actual design.

Step 1:

Specify **Projector Position**.

For more information about projector position, see [Choosing a location on page 11](#).

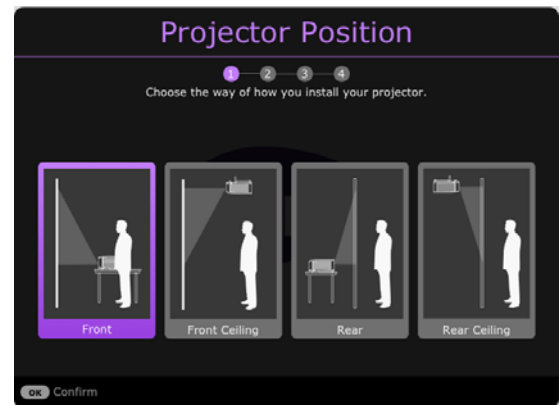

Step 2:

Specify OSD **Language**.

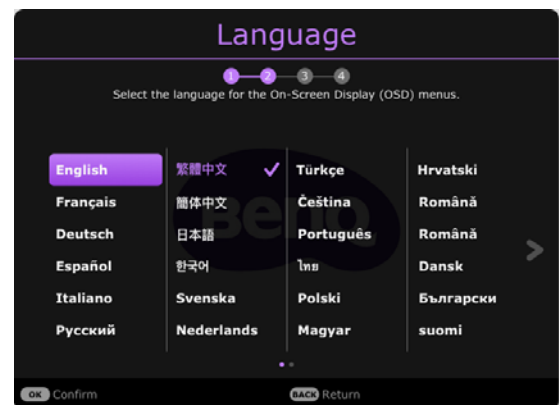

Step 3:

Specify **2D Keystone**, and choose to activate **Auto Vertical Keystone**.

For more information about keystone, see [Correcting keystone on page 15](#).

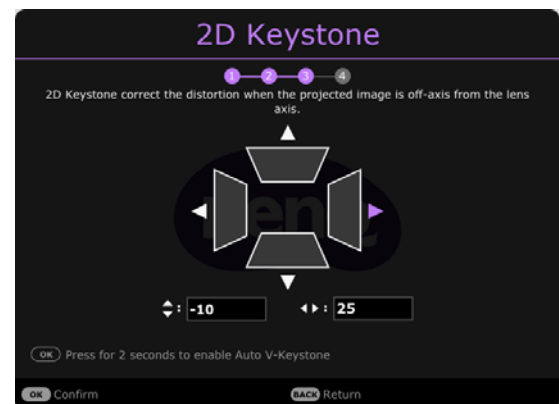

Step 4:

Specify **Game Settings**.

You can turn on the **FPS Game Mode**, and **Details Adjustment** in this menu.

See [Game Settings on page 30](#) for details.

Now you've completed the initial setup.

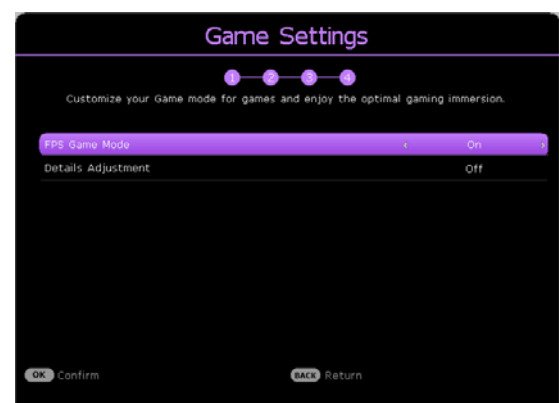

4. If you are prompted for a password, press the arrow keys to enter a 6-digit password. See [Utilizing the password function on page 24](#).

5. Switch all of the connected equipment on.

The projector will search for input signals. The current input signal being scanned appears. If the projector does not detect a valid signal, the message “No Signal” will continue displaying until an input signal is found.

You can also press /**SOURCE** to select your desired input signal. See [Switching input signal on page 25](#).



- Please use the original accessories (e.g. power cord) to avoid possible dangers such as electric shock and fire.
- If the projector is still hot from previous activity, it will run the cooling fan for approximately 90 seconds before energizing the lamp.



-
- The Setup Wizard screenshots are for reference only and may differ from the actual design.
 - If the frequency/resolution of the input signal exceeds the projector's operating range, you will see the message “Out of Range” displayed on the background screen. Please change to an input signal which is compatible with the projector's resolution or set the input signal to a lower setting. See [Timing chart on page 52](#).
 - If no signal is detected for 3 minutes, the projector automatically enters saving mode.
 - If “Reset All Settings” is selected, setup wizard will appear after reboot, and Auto Source will be reset to default value.

Setting up the QS01 HDMI Media Streaming (Optional)

Before you start

Check that you have:

- A Wi-Fi Internet connection
- A Google Account

Step 1:

Press and hold **OK** for 5 seconds to pair your remote control.

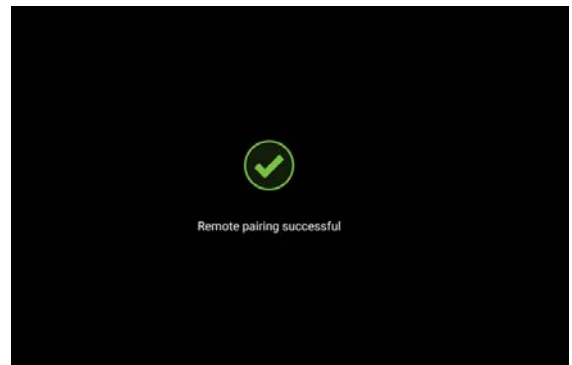
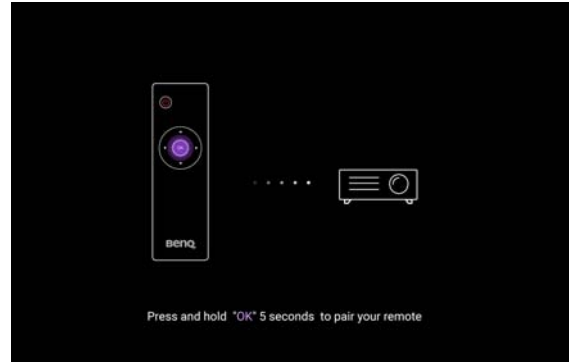

Step 2:

Set up your device.

There are 3 options to set up your device:

- Quick Setup using an Android phone

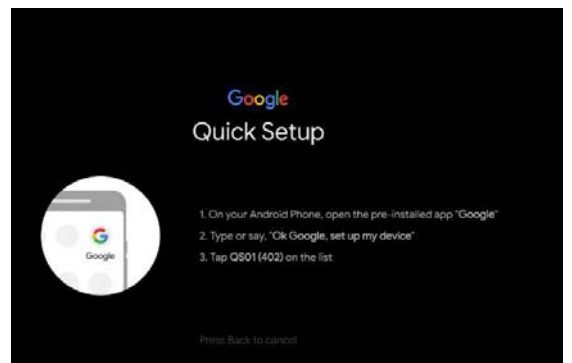

- Using your phone or computer

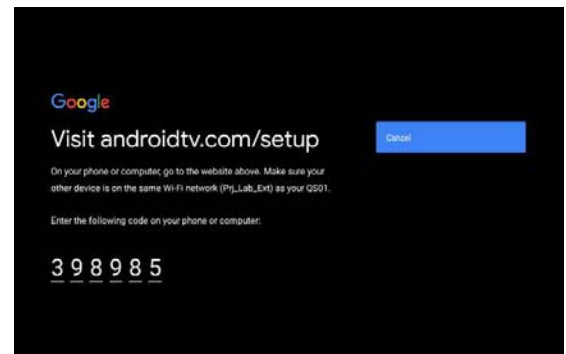

- Using your remote control

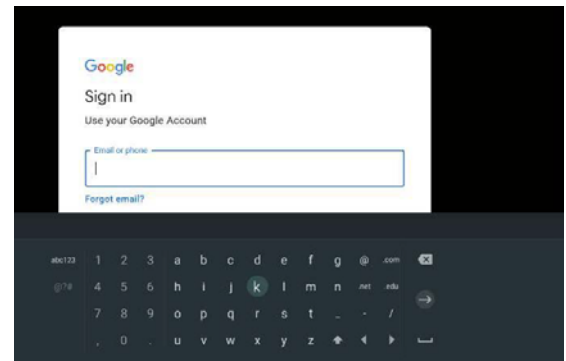

Step 3:
Display Android TV home screen.

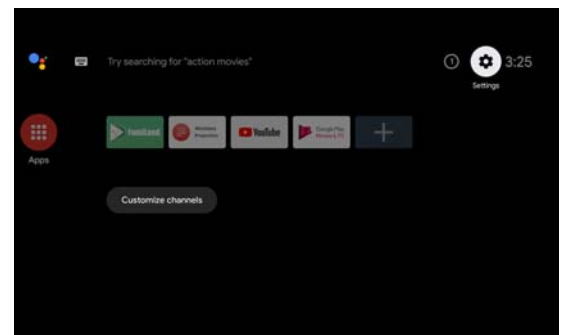

 For more information, visit <https://support.google.com/androidtv/>.

Using the menus

The projector is equipped with 2 types of On-Screen Display (OSD) menus for making various adjustments and settings.

- **Basic** OSD menu: provides primary menu functions. (See [Basic Menu on page 27](#))
- **Advanced** OSD menu: provides full menu functions. (See [Advanced Menu on page 28](#))

To access the OSD menu, press **MENU** on the projector or remote control.

- Use the arrow keys (▲/▼/◀/▶) on the projector or remote control to move through the menu items.
- Use **OK** on the projector or remote control to confirm the selected menu item.

The first time you use the projector (after finishing the initial setup), press **MENU**, and the **Basic** OSD menu will be displayed.



The OSD screenshots below are for reference only, and may differ from the actual design.

Below is the overview of the **Basic** OSD menu.

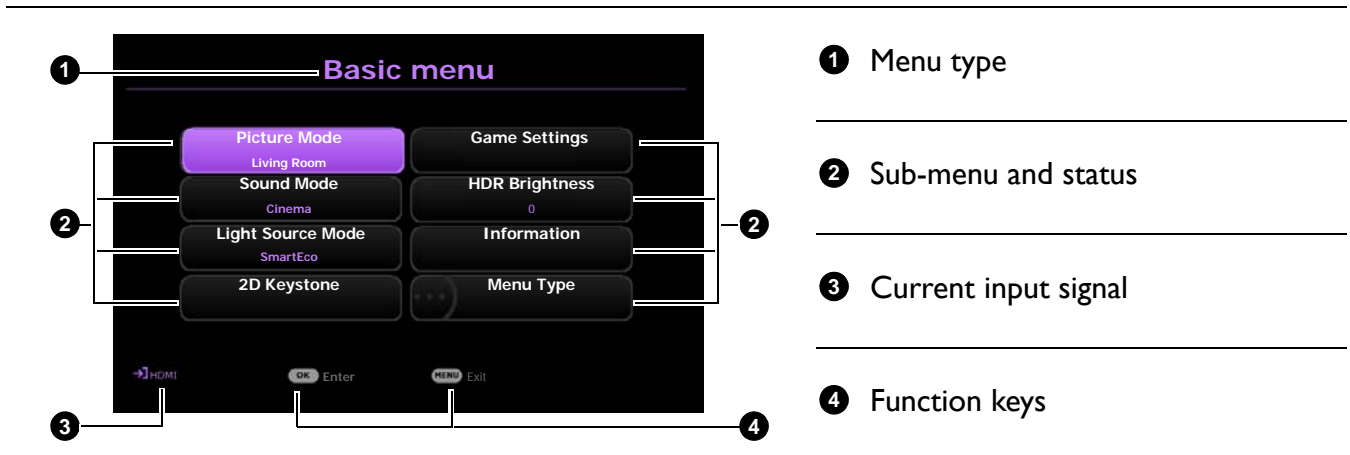

If you intend to switch from the **Basic** OSD menu to the **Advanced** OSD menu, follow the instructions below:

1. Go to **Menu Type** and press **OK**.
2. Press ▲/▼ to select **Advanced** and press **OK**. Your projector will switch to **Advanced** OSD menu.

Below is the overview of the **Advanced** OSD menu.

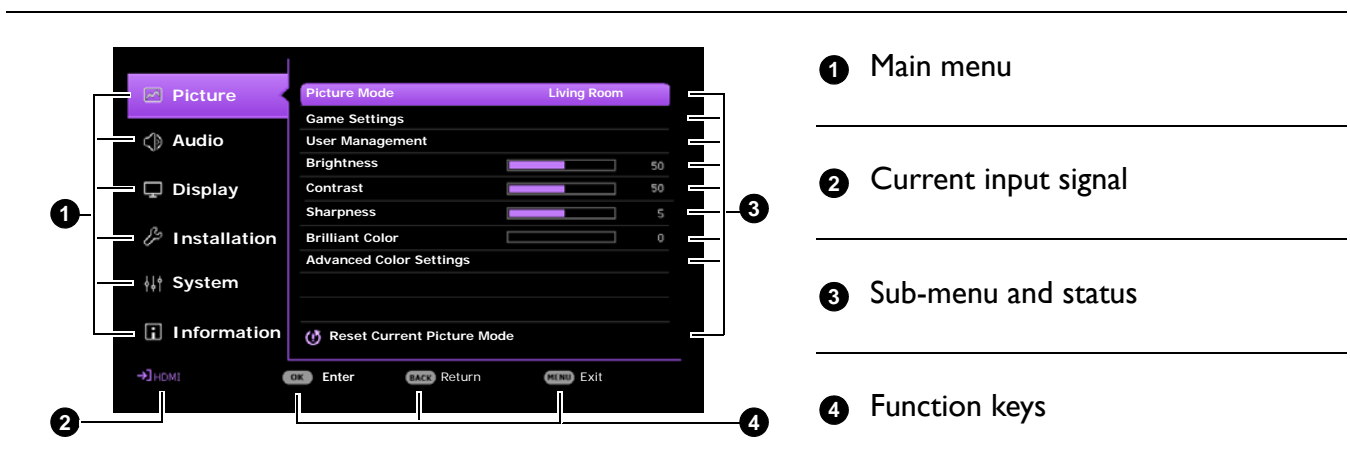

Likewise, when you wish to switch from the **Advanced** OSD menu to the **Basic** OSD menu, follow the instructions below:

1. Go to **System > Menu Settings > Menu Type** and press **OK**.
2. Press **▲/▼** to select **Basic**. Your projector will switch to the **Basic** OSD menu.

Securing the projector

Utilizing the password function

Setting a password

1. Go to **Advanced** menu - **System > Security Settings**. Press **OK**. The **Security Settings** page appears.
2. Highlight **Change Password** and press **OK**.
3. The four arrow keys (**▲, ►, ▼, ◀**) respectively represent 4 digits (1, 2, 3, 4). According to the password you desire to set, press the arrow keys to enter six digits for the password.
4. Confirm the new password by re-entering the new password.
5. To activate the **Power On Lock** function, go to **System > Security Settings > Power On Lock**, press **OK** and **◀/►** to select **On**. Input the password again.

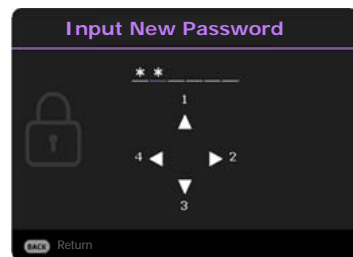

- The digits being input will display as asterisks on-screen. Make a note of your selected password and keep it in a safe place in advance or right after the password is entered so that it is available to you should you ever forget it.
- Once a password has been set and the **Power On Lock** is activated, the projector cannot be used unless the correct password is entered every time the projector is started.

If you forget the password

If you enter the wrong password, the password error message will appear, and the **Input Password** message follows. If you absolutely do not remember the password, you can use the password recall procedure. See [Entering the password recall procedure on page 24](#).

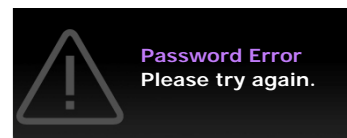

If you enter an incorrect password 5 times in succession, the projector will automatically shut down in a short time.

Entering the password recall procedure

1. Press and hold **OK** for 3 seconds. The projector will display a coded number on the screen.
2. Write down the number and turn off your projector.
3. Seek help from the local BenQ service center to decode the number. You may be required to provide proof of purchase documentation to verify that you are an authorized user of the projector.

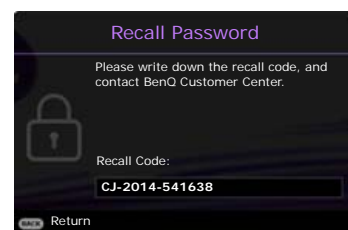

Changing the password

1. Go to **Advanced** menu - **System** > **Security Settings**. Press **OK**. The **Security Settings** page appears.
2. Highlight **Change Password** and press **OK**.
3. Enter the old password.
 - If the password is correct, another message **Input New Password** appears.
 - If the password is incorrect, the password error message will appear, and the message **Input Current Password** appears for your retry. You can press **BACK** to cancel the change or try another password.
4. Enter a new password.
5. Confirm the new password by re-entering the new password.

Disabling the password function

To disable password protection, go to **Advanced** menu - **System** > **Security Settings** > **Power On Lock** and press **OK** and **◀/▶** to select **Off**. The message **Input Password** appears. Enter the current password.

- If the password is correct, the OSD menu returns to the **Security Settings** page. You will not have to enter the password next time turning on the projector.
- If the password is incorrect, the password error message will appear, and the message **Input Current Password** appears for your retry. You can press **BACK** to cancel the change or try another password.



Though the password function is disabled, you need to keep the old password in hand should you ever need to re-activate the password function by entering the old password.

Switching input signal

The projector can be connected to multiple devices at the same time. However, it can only display one full screen at a time. When starting up, the projector automatically searches for the available signals.

Be sure the **Advanced** menu - **Display** > **Auto Source Search** menu is **On** if you want the projector to automatically search for the signals.

To manually select the source:

1. Press **→**/**SOURCE**. A source selection bar appears.
2. Press **▲/▼** until your desired signal is selected and press **OK**.



Once detected, the selected source information will appear at the corner of the screen for seconds. If there is multiple equipment connected to the projector, repeat steps 1-2 to search for another signal.

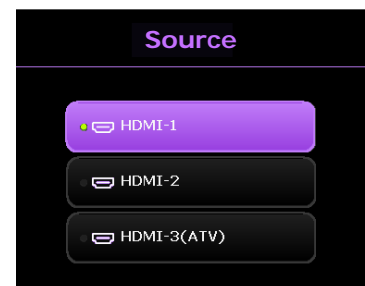

- The brightness level of the projected image will change accordingly when you switch between different input signals.
- For best display picture results, you should select and use an input signal which outputs at the projector's native resolution. Any other resolutions will be scaled by the projector depending upon the "aspect ratio" setting, which may cause some image distortion or loss of picture clarity. See [Aspect Ratio on page 35](#).



Shutting down the projector

1. Press  and a confirmation message will appear prompting you. If you don't respond in a few seconds, the message will disappear.
2. Press  a second time. The power indicator flashes orange, the projection light source shuts down, and the fans will continue to run for approximately 90 seconds to cool down the projector.
3. Once the cooling process finishes, the power indicator becomes a steady orange and fans stop. Disconnect the power cord from the power outlet.

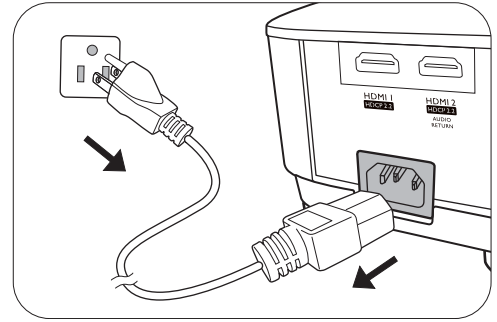

- To protect the light source, the projector will not respond to any commands during the cooling process.
- Avoid turning on the projector immediately after turning it off as excessive heat may shorten lamp life.
- Lamp life results will vary depending on environmental conditions and usage.

Menu operation

Please note that the on-screen display (OSD) menus vary according to the signal type selected and the projector model you are using.

The menu items are available when the projector detects at least one valid signal. If there is no equipment connected to the projector or no signal detected, limited menu items are accessible.

Menu System

Basic Menu

Menu (Ref. Page)	Options
Picture Mode (29)	Bright/Living Room/Game/Sports/Cinema/(3D)/(HDR10)/(HDR Game)/(HLG)/User
Sound Mode (34)	Cinema/Music/Game/Sports/User
Light Source Mode (46)	Normal/ECO/SmartEco/LampSave
2D Keystone (15)	H: -30 – +30 V: -30 – +30
Game Settings (30)	Details Adjustment Off/Low/High
HDR Brightness (32)	-2/-1/0/1/2
Information (43)	Detected Resolution
	Source
	Picture Mode
	Light Source Mode
	3D Format
	Color System
	Dynamic Range
	Light Source Usage Time
	Firmware Version
Service Code	
Menu Type (41)	Basic/Advanced

Advanced Menu

I. Main menu: **Picture**

Structure

Menu		Options	
Picture Mode		Bright/Living Room/Game/Sports/Cinema/3D/HDR10/HDR Game/HLG/User	
Game Settings	Details Adjustment	Off/Low/High	
User Management	Load Settings From	Bright/Living Room/Game/Sports/Cinema	
	Rename User Mode		
Brightness		0-100	
Contrast		0-100	
Sharpness		0-10	
Brilliant Color		0-10	
Gamma Selection		1.8/2.0/2.1/2.2/2.3/2.4/2.5/2.6/BenQ	
Advanced Color Settings	Color Temperature	Normal/Cool/Native/Warm	
	Color Temperature Tuning	R Gain/ G Gain/ B Gain	0-200
		R Offset/ G Offset/ B Offset	0-511
		R/G/B/C/M/Y W Reset	Hue/Saturation/Gain R Gain/G Gain/B Gain
	Light Source Mode	Normal/ECO/SmartEco/LampSave	
	HDR Brightness	-2/-1/0/1/2	
	Reset Current Picture Mode	Reset/Cancel	

Function descriptions

Menu	Descriptions
Picture Mode	<p>The projector is preset with several predefined picture modes so that you can choose one to suit your operating environment and input signal picture type.</p> <ul style="list-style-type: none">• Bright Maximizes the brightness of the projected image. This mode is suitable for environments where extra-high brightness is required, such as using the projector in well lit rooms.• Living Room With well-saturated color, fine-tuned sharpness, and a higher brightness level, this mode is suitable for TV streaming in rooms where there is a small amount of ambient light, e.g. your living room.• Game This mode is best for playing video games, and you can select an optimal Audio-Visual preset for 3 types of games in Game Settings menu: First-Person shooting (FPS), Role-Playing game (RPG), Sports game (SPG) to have a perfect game-play experience in well-lit rooms.• Sports With well-saturated colors and higher brightness level, this mode is best for watching sporting events in a bright room.• Cinema This mode is best for watching movies with accurate color and deepest contrast at lower brightness level in rooms with a bit of ambient light, as if in a commercial cinema.• 3D Optimized to bring up 3D effects when watching 3D contents.  <p>This mode is only available when 3D function is enabled.</p> <ul style="list-style-type: none">• HDR10/HDR Game Delivers High Dynamic Range effects with higher contrasts of brightness and colors for HDR Blu-ray movies or HDR games. After auto-detecting metadata or EOTF info from HDR contents, HDR10 and HDR Game are available for selection. HDR10 is best for displaying Blu-ray movies, while HDR Game is used to activate Game Settings menu for HDR gameplay.• HLG Delivers High Dynamic Range effects with higher contrasts of brightness and colors. Picture Mode will be switched to HLG automatically while detecting metadata or EOTF info from HLG streaming contents.• User Recalls the settings customized based on the current available picture modes. See User Management on page 28.

Game Settings

The following projector settings can minimize the response time between the input source and the displayed image. Please set your projector OSD and input timing at these conditions to enjoy low latency gaming experience.

- 0 for the **Advanced** menu - **Installation > 2D Keystone**
- **Off** for the **Advanced** menu - **Installation > Auto Vertical Keystone**
- **Auto** for the **Advanced** menu - **Display > Aspect Ratio**
- 4K 60Hz, or 1080p 60Hz/120Hz/240Hz for the input timing

- **Details Adjustment**

Adjusts the level of detail clarity. The higher the effect, the more details will be shown but with lower black performance.

There is one user-definable mode if the current available picture modes are not suitable for your need. You can use one of the picture modes (except the **User**) as a starting point and customize the settings.

- **Load Settings From**

1. Go to **Picture > Picture Mode**.
2. Press **◀/▶** to select **User**.
3. Press **▼** to highlight **User Management**, and press **OK**. The **User Management** page is displayed.
4. Select **Load Settings From** and press **OK**.
5. Press **▼/▲** to select a picture mode that is closest to your need.
6. Press **OK** and **BACK** to return to the **Picture** menu.
7. Press **▼** to select the sub-menu items you want to change and adjust the values with **◀/▶**. The adjustments define the selected user mode.

User Management

- **Rename User Mode**

Select to rename the customized picture mode (**User**). The new name can be up to 9 characters including English letters (A-Z, a-z), digits (0-9), and space ().

1. Go to **Picture > Picture Mode**.
2. Press **◀/▶** to select **User**.
3. Press **▼** to highlight **User Management**, and press **OK**. The **User Management** page is displayed.
4. Press **▼** to highlight **Rename User Mode** and press **OK**. The **Rename User Mode** page is displayed.
5. Use **▲/▶/▼/◀**, and **OK** to set desired characters.
6. When done, press **BACK** to save the changes and exit.

Brightness

The higher the value, the brighter the image. Adjust this control so the black areas of the image appear just as black and that detail in the dark areas is visible.

Contrast

The higher the value, the greater the contrast. Use this to set the peak white level after you have previously adjusted the Brightness setting to suit your selected input and viewing environment.

Sharpness

The higher the value, the sharper the picture becomes.

Brilliant Color

This function utilizes a new color-processing algorithm and system level enhancements to enable higher brightness while providing truer, more vibrant colors in picture. It enables a greater than 50% brightness increase in mid-tone images, which are common in video and natural scenes, so the projector reproduces images in realistic and true colors.

• Gamma Selection

Gamma refers to the relationship between input source and picture brightness.

- **1.8/2.0/2.1/BenQ**: Select these values according to your preference.
- **2.2/2.3**: Increases the average brightness of the picture. Best for a lit environment, meeting room or family room.
- **2.4/2.5**: Best for viewing movies in a dark environment.
- **2.6**: Best for viewing movies which are mostly composed of dark scenes.

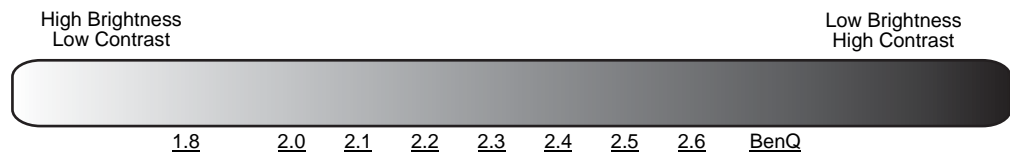

Advanced Color Settings

• Color Temperature Tuning

There are several preset color temperature settings available. The available settings may vary according to the signal type selected.

- **Normal**: Maintains normal colorings for white.
- **Cool**: Makes images appear bluish white.
- **Native**: With the light source's original color temperature and higher brightness. This setting is suitable for environments where high brightness is required, such as projecting pictures in well lit rooms.
- **Warm**: Makes images appear reddish white.

You can also set a preferred color temperature by adjusting the following options.

- **R Gain/G Gain/B Gain**: Adjusts the contrast levels of Red, Green, and Blue.
 - **R Offset/G Offset/B Offset**: Adjusts the brightness levels of Red, Green, and Blue.
-

• Color Management

The Color Management provides six sets (RGBCMY) of colors to be adjusted. When you select each color, you can independently adjust its range and saturation according to your preference.

To make adjustments, press the ▲/▼ arrows to highlight an independent color from among Red (R), Green (G), Blue (B), Cyan (C), Magenta (M), or Yellow (Y), and press **OK**. The following menu items are displayed for your choice.

- **Hue:** Increase in the range will include colors consisted of more proportions of its two adjacent colors. Please refer to the illustration for how the colors relate to each other.

For example, if you select Red and set its range at 0, only pure red in the projected picture will be selected. Increasing its range will include red close to yellow and red close to magenta.

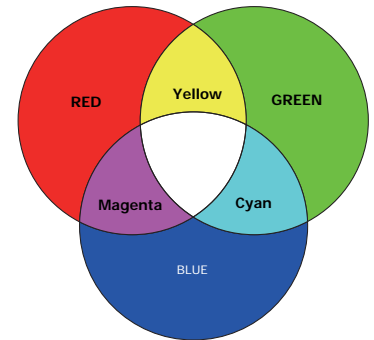

- **Saturation:** Adjusts the values to your preference. Every adjustment made will reflect to the image immediately. For example, if you select Red and set its value at 0, only the saturation of pure red will be affected.
- **Gain:** Adjusts the values to your preference. The contrast level of the primary color you select will be affected. Every adjustment made will reflect to the image immediately.

Advanced Color Settings (Continued)

If you selected **W**, you can adjust the contrast levels of Red, Green, and Blue by selecting **R Gain**, **G Gain**, and **B Gain**.

To return all the settings to the factory default values, highlight **Reset**, and press **OK**.



Saturation is the amount of that color in a video picture. Lower settings produce less saturated colors; a setting of “0” removes that color from the image entirely. If the saturation is too high, that color will be overpowering and unrealistic.

• Light Source Mode

Selects a suitable light source power from among the provided modes. See [Extending light source life on page 46](#).

• HDR Brightness

The projector can automatically adjust the brightness levels of your image according to the input source. You can also manually select a brightness level to display better picture quality. When the value is higher, the image becomes brighter; when the value is lower, the image becomes darker.

Reset Current Picture Mode

Returns all of the adjustments you've made for the selected **Picture Mode** (including the preset mode, **User**) to the factory preset values.

1. Press **OK**. The confirmation message is displayed.
2. Use **◀/▶** to select **Reset** and press **OK**. The current picture mode returns to the factory preset settings.



The following settings will still remain: **Picture Mode**.

2. Main menu: **Audio**

Structure

Menu	Options
Sound Mode	Cinema/Music/Game/Sports/User
User Sound EQ	100Hz/300Hz/ 1kHz/3kHz/10kHz -10 – +10
Mute	Off/On
Volume	0 – 20
Power On/Off Ring Tone	Off/On
Reset Audio	Reset/Cancel

Function descriptions

Menu	Descriptions
Sound Mode	<p>This function utilizes treVolo and Bongiovi DPS (Digital Power Station) Technology, which incorporates its patented algorithms with 120 calibration points that optimizes any audio signal in real time to add depth, clarity, definition, presence and enhanced stereo field imaging for more immersive audio experience. The following preset sounds are available: Cinema, Music, Game, Sports, and User.</p> <p>The User mode allows you to personalize the sound settings. When selecting the User mode, you may make manual adjustments with the User Sound EQ function.</p> <p>If the Mute function is activated, adjusting Sound Mode will turn off the Mute function.</p>
User Sound EQ	Select desired frequency bands (100 Hz, 300 Hz, 1k Hz, 3k Hz, and 10k Hz) to adjust the levels according to your preference. The settings made here define the User mode.
Mute	Select On to temporarily turn off the projector's internal speaker or the volume being output from the audio output jack. To restore the audio, select Off .
Volume	Adjusts the volume level of the projector's internal speaker or the volume being output from the audio output jack. If the Mute function is activated, adjusting Volume will turn off the Mute function.
Power On/Off Ring Tone	Sets the ring tone for the projector On or Off . The Power On/Off Ring Tone can only be adjusted here. Setting the sound mute or adjusting the sound level do not affect the Power On/Off Ring Tone .
Reset Audio	Returns all of the adjustments you've done under the Audio menu to the factory preset values.

3. Main menu: **Display**

Structure

Menu		Options
Aspect Ratio		Auto/4:3/16:9
Auto Source Search		Off/On
Source Rename		HDMI-1/HDMI-2
3D	3D Mode	Auto/Frame Sequential/Frame Packing/Top-Bottom/Side by Side/Off
	3D Sync Invert	Disable/Invert
HDMI Format		Auto/Limited/Full
HDMI Equalizer	HDMI-1/HDMI-2	Auto/1/2/3/4/5
HDMI EDID	HDMI-1/HDMI-2/ HDMI-3	Enhanced/Standard
HDMI Settings	Electronics Control	Off/On
	Audio Return + (HDMI-2)	Off/LPCM/RAW /RAW+
	Power On Link	Off/From Device
	Power Off Link	Off/From Projector
Reset Display		Reset/Cancel

Function descriptions

Menu	Descriptions
Aspect Ratio	<p>There are several options to set the image's aspect ratio depending on your input signal source.</p> <p>This image adjustment might impact latency in Game Mode. We suggest setting Aspect Ratio to Auto to enjoy low latency gaming.</p> <ul style="list-style-type: none"> • Auto: Scales an image proportionally to fit the projector's native resolution in its horizontal or vertical width. • 4:3: Scales an image so that it is displayed in the center of the screen with a 4:3 aspect ratio. • 16:9: Scales an image so that it is displayed in the center of the screen with a 16:9 aspect ratio.
Auto Source Search	Allows the projector to automatically search for a signal.

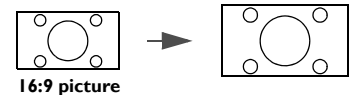
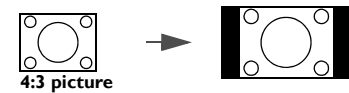
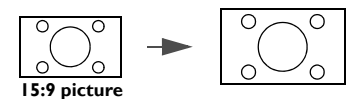

Renames the current input source to your desired name.

On the **Source Rename** page:

Source Rename

1. Press **OK** to display the on-screen keyboard.
2. Press **▲/▼/◀/▶** to select each desired digit/letter, and press **OK** to confirm each input.
3. Repeat the step above and when done, press **BACK** and **▼** to highlight **Commit**.
4. Press **OK** and the source name changes.

This projector supports playing three-dimensional (3D) content transferred through your 3D-compatible video devices and contents, such as PlayStation consoles (with 3D game discs), 3D Blu-ray players (with 3D Blu-ray discs), and so on. After you have connected the 3D video devices to the projector, wear the BenQ 3D glasses and make sure the power is on to view 3D contents.

When watching 3D contents:

- The image may seem misplaced; however, this is not a product malfunction.
- Take appropriate breaks when watching 3D contents.
- Stop watching 3D contents if you feel fatigue or discomfort.
- Keep a distance from the screen of about three times the effective height of the screen.
- Children and people with a history of oversensitivity to light, heart problems, or any other existing medical conditions should be refrained from watching 3D contents.
- The image may seem reddish, greenish, or bluish without wearing 3D glasses. However, you will not notice any color bias when watching 3D contents with 3D glasses.
- The 4K source will not be displayed.

3D

• 3D Mode

The default setting is **Auto** and the projector automatically chooses an appropriate 3D format when detecting 3D contents. If the projector cannot recognize the 3D format, you can choose **Frame Sequential**, **Frame Packing**, **Top-Bottom**, or **Side by Side** for it.

When **3D Mode** is enabled:

- The brightness level of the projected image decreases.
- The **Picture Mode** cannot be adjusted.
- The **2D Keystone** can only be adjusted within limited degrees.

• 3D Sync Invert

When your 3D image is distorted, enable this function to switch between the image for the left eye and the right eye for more comfortable 3D viewing experience.

- **HDMI Format**

Selects a suitable RGB color range to correct the color accuracy.

- **Auto:** Automatically selects a suitable color range for the incoming HDMI signal.
- **Limited:** Utilizes the Limited range RGB 16-235.
- **Full:** Utilizes the Full range RGB 0-255.

- **HDMI Equalizer**

Sets a suitable value to maintain the HDMI picture quality in long distance data transmission.

- **HDMI EDID**

Switches between **Enhanced** for HDMI 2.0 EDID and **Standard** for HDMI 1.4 EDID. Selecting **Standard** which supports up to 1080p 60Hz may solve abnormal display issues with some old players.

- **Electronics Control**

When you enable this function and connect an HDMI CEC-compatible device to your projector with an HDMI cable, turning on the HDMI CEC compatible device automatically turns on the projector, while turning off the projector automatically turns off the HDMI CEC compatible device.

- **Audio Return + (HDMI-2)**

When connecting to eARC compatible speaker to the projector with HDMI cables, the audio can be returned to these speakers from the projector HDMI 2 port.

HDMI-1 can output audio to external speakers via eARC function (**HDMI-2**).

Audio Return+ supports multi-audio outputs including 2.0, 5.1, 7.1 and Dolby Atmos to external audio system like soundbar.

The following audio output formats are provided to achieve the audio performance you desire: **LPCM** supports 2 channel audio output, **RAW** supports 5.1 channel audio output, and **RAW+** supports Dolby Atmos audio output.

To enjoy **Audio Return+** sound effect, make sure to turn on the eARC function from your soundbar as well.

- **Power On Link/Power Off Link**

When you connect an HDMI CEC-compatible device to your projector with an HDMI cable, you can set the behavior of powering on/off between the device and the projector.

Power On Link > From Device	When the connected device is turned on, the projector will be activated, too.
Power Off Link > From Projector	When the projector is turned off, the connected device will be shut down, too.

HDMI Settings

Reset Display

Returns all the settings on the **Display** main menu to the factory default values.

4. Main menu: Installation

Structure

Menu	Options
Projector Position	Front/Front Ceiling/Rear/Rear Ceiling
2D Keystone	H: -30 – +30
	V: -30 – +30
Auto Vertical Keystone	Off/On
LumiExpert	LumiExpert Off/On
	LumiExpert Level -1 – 0 – 1
	Manual Calibration
	Manual Calibration Status Calibrate Reset Manual Calibration
Test Pattern	Off/On
High Altitude Mode	Off/On
Baud Rate	9600/14400/19200/38400/57600/115200

Function descriptions

Menu	Descriptions
Projector Position	The projector can be installed on a ceiling or behind a screen, or with one or more mirrors. See Choosing a location on page 11 for details.
2D Keystone	See Correcting keystone on page 15 for details. This image adjustment might impact latency in Game Mode . We suggest setting the 2D Keystone values to 0 to enjoy low latency gaming.
Auto Vertical Keystone	Automatically corrects the keystone on the vertical side of the projected image. This image adjustment might impact latency in Game Mode . We suggest turning Auto Vertical Keystone off to enjoy low latency gaming.
LumiExpert	<ul style="list-style-type: none"> • LumiExpert <p>When this function is enabled, the projector actively detects the ambient light conditions and automatically adjusts balanced visual brightness to create an optimum viewing experience.</p>  <p>This function is not available when the Picture Mode is Bright, 3D, or HDR10/HLG.</p> <ul style="list-style-type: none"> • LumiExpert Level: Adjusts the gamma offset. • Manual Calibration: According to the ambient brightness, you can do the calibration manually. <ul style="list-style-type: none"> • Manual Calibration Status: Shows the status of manual calibration. • Calibrate: Enact this item to start the calibration process. • Reset Manual Calibration: Resets the gamma offset to factory preset values.

Test Pattern

Adjusts the image size and focus and check that the projected image is free from distortion.

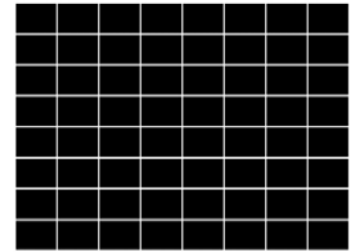

High Altitude Mode

We recommend you use the **High Altitude Mode** when your environment is between 1500 m–3000 m above sea level, and ambient temperature is between 0°C–30°C.

Operation under "**High Altitude Mode**" may cause a higher decibel operating noise level because of increased fan speed necessary to improve overall system cooling and performance.

If you use this projector under other extreme conditions excluding the above, it may display auto shut-down symptoms, which is designed to protect your projector from over-heating. In cases like this, you should switch to High Altitude mode to solve these symptoms. However, this is not to state that this projector can operate under any and all harsh or extreme conditions.



Do not use the **High Altitude Mode** if your altitude is between 0 m and 1500 m and ambient temperature is between 0°C and 35°C. The projector will be over cooled, if you turn the mode on under such a condition.

Baud Rate

Select a baud rate that is identical with your computer's so that you can connect the projector with a suitable RS-232 cable and update or download the projector's firmware. This function is intended for qualified service personnel.

5. Main menu: **System**

Structure

Menu		Options	
Language		English/Français/Deutsch/Italiano/Español/ Русский/繁體中文/简体中文/日本語/한국어/ Svenska/Nederlands/Türkçe/Čeština/ Português/ไทย/Polski/Magyar/Hrvatski/ Română/Norsk/Dansk/Български/Suomi/ Indonesian/Ελληνικά/العربية/हिन्दी	
Background Settings	Splash Screen	BenQ/Black/Blue	
Menu Settings	Menu Type	Basic/Advanced	
	Menu Display Time	5 sec/10 sec/20 sec/30 sec/Always	
	Menu Position	Center/Top-Left/Top-Right/Bottom-Right/Bottom-Left	
Light Source Information	Light Source Usage Time		
	Normal Mode		
	ECO Mode		
	SmartEco Mode		
	LampSave		
	Equivalent Light Hours		
	Refer to UM for detailed formula		
	Reset Light Timer	Reset/Cancel	
Operation Settings	Reminder Message	Off/On	
	LED Indicator	Off/On	
	Power On/Off Settings	Direct Power On	Off/On
		Auto Power Off	Disable/3 min/10 min/15 min/20 min/25 min/30 min
	BenQ HDMI Media Streaming (QS01)	Off/On	Yes/Cancel
Security Settings	Panel Key Lock	Off/On	Yes/No
	Change Password		
	Power On Lock		
Factory Default		Reset/Cancel	
Reset System		Reset/Cancel	

Function descriptions

Menu	Descriptions
Language	Sets the language for the On-Screen Display (OSD) menus.
Background Settings	<ul style="list-style-type: none"> • Splash Screen Allows you to select which logo screen will be displayed during projector start-up.

Menu Settings

- **Menu Type**

Sets the OSD menu type according to your needs.

- **Menu Display Time**

Sets the length of time the OSD will remain active after your last key press.

- **Menu Position**

Sets the On-Screen Display (OSD) menu position.

Light Source Information

This menu page displays the following information:

- **Light Source Usage Time**

- Light hours used under **Normal Mode, ECO Mode, SmartEco Mode, LampSave.**

- And the **Equivalent Light Hours.**

For details about how to calculate the hours, see [Getting to know the light hour on page 45.](#)

When a new lamp is installed, and you need to reset the timer, highlight **Reset Light Timer** and select **Reset**.

Operation Settings

- **Reminder Message**

Sets the reminder messages on or off.

- **LED Indicator**

You can turn off the LED warning lights. This is to avoid any light disturbance when viewing images in a dark room.

- **Power On/Off Settings**

- **Direct Power On:** Allows the projector to turn on automatically once the power is fed through the power cord.

- **Auto Power Off:** Allows the projector to turn off automatically if no input signal is detected after a set period of time to prevent unnecessary waste of light source life.

- **BenQ HDMI Media Streaming (QS01)**

With the optional QS01 installed on your projector (see [Installing the QS01 HDMI Media Streaming \(Optional\) on page 18](#)), you can select **On** to enable functions related to the Android TV dongle (QS01), including:

- the reminder for plugging in ATV dongle.

- the handshaking mechanism between the Android TV dongle and projector after power-on.

• Panel Key Lock

With the control keys on the projector and remote control locked, you can prevent your projector settings from being changed accidentally (by children, for example). When the **Panel Key Lock** is on, no control keys on the projector and remote control will operate except  **POWER**.

Security Settings

To release panel key lock, press and hold  (the right key) on the projector or remote control for 3 seconds.



If you turn off the projector without disabling panel key lock, the projector will still be in locked status the next time it is turned on.

• Change Password/Power On Lock

See [Utilizing the password function on page 24](#).

Returns all settings to the factory preset values.

Factory Default



The following settings will still remain: **Projector Position, 2D Keystone, Auto Vertical Keystone, High Altitude Mode, Baud Rate, Light Source Information, BenQ HDMI Media Streaming (QS01), Security Settings.**

Returns all the settings on the **System** main menu to the factory default values.

Reset System



The following settings will still remain: **Light Source Information, BenQ HDMI Media Streaming (QS01), Security Settings.**

6. Main menu: Information

Structure

Menu	Options
Detected Resolution	
Source	
Picture Mode	
Light Source Mode	
3D Format	
Color System	
Dynamic Range	
Light Source Usage Time	
Firmware Version	
Service Code	

Function descriptions

Menu	Descriptions
Detected Resolution	Shows the native resolution of the input signal.
Source	Shows the current signal source.
Picture Mode	Shows the selected mode on the Picture menu.
Light Source Mode	Shows the used light source mode.
	Displays the current 3D mode.
3D Format	 3D Format is only available when 3D is enabled.
Color System	Shows the input system format.
Dynamic Range	Shows the picture dynamic range, e.g. SDR, HDR10, HLG, etc.
Light Source Usage Time	Shows the number of hours the light has been used.
Firmware Version	Shows the firmware version of your projector.
Service Code	Shows the projector's serial number.

Maintenance

Care of the projector

Cleaning the lens

Clean the lens whenever you notice dirt or dust on the surface. Please be sure to turn off the projector and let it cool down completely before cleaning the lens.

- Use a canister of compressed air to remove dust.
- If there is dirt or smears, use lens-cleaning paper or moisten a soft cloth with lens cleaner and gently wipe the lens surface.
- Never use any type of abrasive pad, alkaline/acid cleaner, scouring powder, or volatile solvent, such as alcohol, benzene, thinner or insecticide. Using such materials or maintaining prolonged contact with rubber or vinyl materials may result in damage to the projector surface and cabinet material.

Cleaning the projector case

Before you clean the case, turn the projector off using the proper shutdown procedure as described in [Shutting down the projector on page 26](#) and unplug the power cord.

- To remove dirt or dust, wipe the case with a soft, lint-free cloth.
- To remove stubborn dirt or stains, moisten a soft cloth with water and a neutral pH detergent. Then wipe the case.



Never use wax, alcohol, benzene, thinner or other chemical detergents. These can damage the case.

Storing the projector

If you need to store the projector for an extended time, please follow the instructions below:

- Make sure the temperature and humidity of the storage area are within the recommended range for the projector. Please refer to [Specifications on page 50](#) or consult your dealer about the range.
- Retract the adjuster feet.
- Remove the battery from the remote control.
- Pack the projector in its original packing or equivalent.

Transporting the projector

It is recommended that you ship the projector with its original packing or equivalent.

Light source information

Getting to know the light hour

When the projector is in operation, the duration (in hours) of light source usage is automatically calculated by the built-in timer. The method of calculating the equivalent light hour is as follows:

1. Light Usage Time = $(x+y1+y2+z+a)$ hours, if:
Time used in **Normal** mode = x hours
Time used in **ECO** mode = y1 hours
Time used in **ECO2** mode = y2 hours
Time used in **SmartEco** mode = z hours
Time used in **LampSave** mode = a hours

2. Equivalent Light Hour = α hours

$$\alpha = \frac{A'}{X} \times x + \frac{A'}{Y1} \times y1 + \frac{A'}{Y2} \times y2 + \frac{A'}{Z} \times z + \frac{A'}{A} \times a, \text{ if}$$

X= light source life spec of **Normal** mode

Y1= light source life spec of **ECO** mode (when using **Bright** picture mode)

Y2= light source life spec of **ECO2** mode (when using the rest picture modes)

Z= light source life spec of **SmartEco** mode

A= light source life spec of **LampSave** mode

A' is the longest light life spec among X, Y1, Y2, Z, A



For time used in each light mode shown in OSD menu:

- **ECO** mode and **ECO2** mode are combined and displayed as **ECO** mode in the OSD menu. The formula is for reference only.
- Time used is accumulated and rounded down to an integer in **hours**.
- When time used is less than 1 hour, it shows 0 hours.



When you calculate **Equivalent Light Hours** manually, it will probably have deviation from the value shown in OSD menu since projector system calculates time used for each light mode in "Minutes" then rounds down to an integer in hours shown in OSD.

To obtain the light hour information:

Go to **Advanced** menu - **System** > **Light Source Information** and press **OK**. The **Light Source Information** page appears.

You can also get the light hour information on the **Information** menu.

Extending light source life

• Setting the **Light Source Mode**

Go to **Advanced** menu - **Picture** > **Advanced Color Settings** > **Light Source Mode**, press **OK**. The **Light Source Mode** page appears.

Setting the projector in **ECO**, **SmartEco** or **LampSave** mode extends lamp life.

Light Mode	Description
Normal	Provides full light brightness
ECO	Lowers brightness to extend the light life and decreases the fan noise
SmartEco	Adjusts the light power automatically depending on the content brightness level while optimizing display quality
LampSave	Adjusts the light power automatically depending on the content brightness level while offering a longer light life

• Setting **Auto Power Off**

This function allows the projector to turn off automatically if no input signal is detected after a set period of time to prevent unnecessary waste of light source life.

To set **Auto Power Off**, go to **Advanced** menu - **System** > **Operation Settings** > **Power On/Off Settings** > **Auto Power Off** and press **◀/▶** to set a period of time.

Timing of replacing the lamp (FOR SERVICE PERSONNEL ONLY)

When the **LIGHT indicator** lights up or a message appears suggesting it is time to replace the lamp, please consult your dealer or go to <http://www.BenQ.com> before installing a new lamp. An old lamp may cause a malfunction in the projector and in some instances the light may explode.



- The apparent brightness of the projected image will vary depending on the ambient lighting conditions, selected input signal contrast/brightness settings, and is directly proportional to projection distance.
- The lamp brightness will decline over time and may vary within the lamp manufacturers specifications. This is normal and expected behavior.
- The **LIGHT indicator light** and **TEMPerature warning light** will light up if the lamp becomes too hot. Turn the power off and let the projector cool for 45 minutes. If the Light or Temp indicator still lights up after turning the power back on, please contact your dealer. See [Indicators on page 48](#).

The following Lamp warning displays will remind you to change the lamp.



















































	<p>Install a new lamp for optimal performance. Press OK to dismiss the message.</p>
	<p>It is strongly recommended that you replace the lamp at this age. The lamp is a consumable item. The lamp brightness diminishes with use. This is normal lamp behavior. You can replace the lamp whenever you notice that the brightness level has significantly diminished. Press OK to dismiss the message.</p>









<p>Notice</p> <hr/> <p>Replace lamp now Equivalent lamp hour > XXXX hours</p> <p>Order a new lamp at www.BenQ.com</p> <p>OK</p>	<p>The lamp MUST be replaced before the projector will operate normally. Press OK to dismiss the message.</p>
<p>Notice</p> <hr/> <p>Out of lamp usage time Replace lamp (Refer to user manual) then reset the lamp timer</p> <p>Order a new lamp at www.BenQ.com</p> <p>OK</p>	



"XXXX" shown in the above messages are numbers that vary depending on different models.

Indicators

Indicator			Status & Description
POWER ○	TEMP ○	LIGHT ○	
Power events			
			Stand-by mode
			Powering up
			Normal operation
			Normal power-down cooling
			Download
			CW start fail
			Light source life exhausted
			Case open
Burn-In events			
			Burn-in ON
			Burn-in OFF
Light source events			
			Light source error in normal operation
			Light source is not lit up
Thermal events			
			Fan 1 error (the actual fan speed is outside the desired speed)
			Fan 2 error (the actual fan speed is outside the desired speed)
			Fan 3 error (the actual fan speed is outside the desired speed)
			Temperature 1 error (over limited temperature)
			Thermal IC #1 I2C connection error

	 : Off	 : Orange On	 : Green On	 : Red On
		 : Orange Flashing	 : Green Flashing	 : Red Flashing

Troubleshooting

? The projector does not turn on.

Cause	Remedy
There is no power from the power cord.	Plug the power cord into the AC power jack on the projector, and plug the power cord into the power outlet. If the power outlet has a switch, make sure that it is switched on.
Attempting to turn the projector on again during the cooling process.	Wait until the cooling down process has completed.

? No picture

Cause	Remedy
The video source is not turned on or connected correctly.	Turn the video source on and check that the signal cable is connected correctly.
The projector is not correctly connected to the input signal device.	Check the connection.
The input signal has not been correctly selected.	Select the correct input signal with the  /SOURCE key.

? Blurred image

Cause	Remedy
The projection lens is not correctly focused.	Adjust the focus of the lens using the focus ring.
The projector and the screen are not aligned properly.	Adjust the projection angle and direction as well as the height of the projector if necessary.

? Remote control does not work.

Cause	Remedy
The batteries are out of power.	Replace both of the batteries with new ones.
There is an obstacle between the remote control and the projector.	Remove the obstacle.
You are too far away from the projector.	Stand within 8 meters (26 feet) of the projector.

? The password is incorrect.

Cause	Remedy
You do not remember the password.	See Entering the password recall procedure on page 24.

Specifications

Projector specifications



All specifications are subject to change without notice.

Optical

Resolution

3840 x 2160

Display system

1-CHIP DMD

Lens

F = 1.94 ~ 2.12, f = 11.9 ~ 15.5 mm

Light source

240 W lamp

Electrical

Power supply

AC100–240V, 3.8 A, 50–60 Hz (Automatic)

Power consumption

380 W (Max); < 0.5 W (Standby)

Mechanical

Weight

3.1 Kg (6.8 lbs)

Output terminals

Speaker

5 watt x 1

Audio signal output

PC audio jack x 1

Control

USB

Type-A power supply 5V / 1.5 A x 1

RS-232 serial control

9 pin x 1

IR receiver x 2

Input terminals

Video signal input

Digital - HDMI 2.0 x 2

Digital - QS01 HDMI Media Streaming port

(ATV dongle) x 1

Environmental Requirements

Operating temperature

0°C–40°C at sea level

Operating relative humidity

10%–90% (without condensation)

Operating altitude

0–1499 m at 0°C–35°C

1500–3000 m at 0°C–30°C (with

High Altitude Mode on)

Storage temperature

-20°C–60°C at sea level

Storage humidity

10%–90% RH (without condensation)

Storage altitude

30°C @ 0–12,200m above sea level

Transporting

Original packing or equivalent is recommended

Repairing

Please visit below website and choose your country to find your service contact window.

<http://www.benq.com/welcome>

Dimensions

312 mm (W) x 246 mm (D) x 110 mm (H)

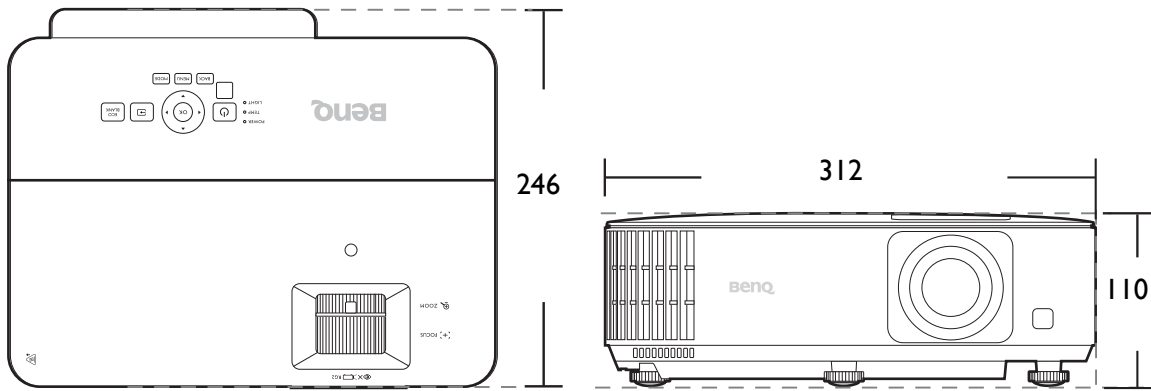

Unit: mm

Timing chart

Supported timing for HDMI (HDCP) input

• PC timings

Resolution	Mode	Vertical Frequency (Hz)	Horizontal Frequency (kHz)	Pixel Frequency (MHz)	Supported 3D format		
					Frame Sequential	Top-Bottom	Side by Side
640 x 480	VGA_60	59.940	31.469	25.175	V	V	V
	VGA_72	72.809	37.861	31.500			
	VGA_75	75.000	37.500	31.500			
	VGA_85	85.008	43.269	36.000			
	VGA_120**	119.518	61.910	52.500			
720 x 400	720 x 400_70	70.087	31.469	28.3221			
800 x 600	SVGA_60	60.317	37.879	40.000	V	V	V
	SVGA_72	72.188	48.077	50.000			
	SVGA_75	75.000	46.875	49.500			
	SVGA_85	85.061	53.674	56.250			
	SVGA_120 (Reduce Blanking)	119.854	77.425	83.000	V		
1024 x 768	XGA_60	60.004	48.363	65.000	V	V	V
	XGA_70	70.069	56.476	75.000			
	XGA_75	75.029	60.023	78.750			
	XGA_85	84.997	68.667	94.500			
	XGA_120 (Reduce Blanking)	119.989	97.551	115.500	V		
1152 x 864	1152 x 864_75	75.00	67.500	108.000			
1024 x 576	BenQ Notebook Timing	60.00	35.820	46.996			
1024 x 600	BenQ Notebook Timing	64.995	41.467	51.419			
1280 x 720	1280 x 720_60	60	45.000	74.250	V	V	V
1280 x 768	1280 x 768_60	59.870	47.776	79.5	V	V	V
1280 x 800	WXGA_60	59.810	49.702	83.500	V	V	V
	WXGA_75	74.934	62.795	106.500			
	WXGA_85	84.880	71.554	122.500			
	WXGA_120 (Reduce Blanking)	119.909	101.563	146.25	V		
1280 x 1024	SXGA_60	60.020	63.981	108.000		V	V
	SXGA_75	75.025	79.976	135.000			
	SXGA_85	85.024	91.146	157.500			
1280 x 960	1280 x 960_60	60.000	60.000	108		V	V
	1280 x 960_85	85.002	85.938	148.500			
1360 x 768	1360 x 768_60	60.015	47.712	85.500		V	V
1440 x 900	WXGA+_60	59.887	55.935	106.500		V	V
1400 x 1050	SXGA+_60	59.978	65.317	121.750		V	V
1600 x 1200	UXGA	60.000	75.000	162.000			
1680 x 1050	1680 x 1050_60	59.954	65.290	146.250		V	V
640 x 480@67Hz	MAC13	66.667	35.000	30.240			
832 x 624@75Hz	MAC16	74.546	49.722	57.280			
1024 x 768@75Hz	MAC19	75.020	60.241	80.000			
1152 x 870@75Hz	MAC21	75.06	68.68	100.00			
1920 x 1080@60Hz	1920 x 1080_60	60	67.5	148.5	V	V	V

1920 x 1200@60Hz	1920 x 1200_60 (Reduce Blanking)	59.95	74.038	154	V		
1920 x 1080@120Hz	1920 x 1080_120	120.000	135.000	297	V		
1920 x 1200@120Hz	1920 x 1200_120 (Reduce Blanking)	119.909	152.404	317.00	V		



The timings showing above may not be supported due to EDID file and VGA graphics card limitations. It is possible that some timings cannot be chosen.

• Video timings

Timing	Resolution	Vertical Frequency (Hz)	Horizontal Frequency (kHz)	Pixel Frequency (MHz)	Supported 3D format			
					Frame Sequential	Frame Packing	Top-Bottom	Side by Side
480i	720(1440) x 480	59.94	15.73	27				
480p	720 x 480	59.94	31.47	27	V		V	
576i	720(1440) x 576	50	15.63	27				
576p	720 x 576	50	31.25	27	V		V	
720/50p	1280 x 720	50	37.5	74.25		V	V	V
720/60p	1280 x 720	60	45.00	74.25	V	V	V	V
1080/24P	1920 x 1080	24	27	74.25		V	V	V
1080/25P	1920 x 1080	25	28.13	74.25				
1080/30P	1920 x 1080	30	33.75	74.25				
1080/50i	1920 x 1080	50	28.13	74.25				V
1080/60i	1920 x 1080	60	33.75	74.25				V
1080/50P	1920 x 1080	50	56.25	148.5			V	V
1080/60P	1920 x 1080	60	67.5	148.5	V		V	V
2160/24P	3840 x 2160	24	54	297				
2160/25P	3840 x 2160	25	56.25	297				
2160/30P	3840 x 2160	30	67.5	297				
2160/50P	3840 x 2160	50	112.5	594				
2160/60P	3840 x 2160	60	135	594				
2160/24P	4096 x 2160	24	54	297				
2160/25P	4096 x 2160	25	56.25	297				
2160/30P	4096 x 2160	30	67.5	297				
2160/50P	4096 x 2160	50	112.5	594				
2160/60P	4096 x 2160	60	135	594				

RS232 command

RS232 pin assignment

No.	Serial
1	NC
2	RX
3	TX
4	NC
5	GND

No.	Serial
6	NC
7	RTSZ
8	CTSZ
9	NC

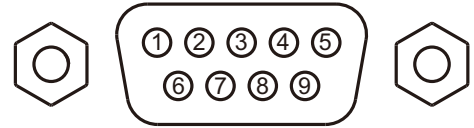

Function	Type	Operation	ASCII
Power	Write	Power On	<CR>*pow=on#<CR>
	Write	Power Off	<CR>*pow=off#<CR>
	Read	Power Status	<CR>*pow=?#<CR>
Source Selection	Write	HDMI(MHL)	<CR>*sour=hdmi#<CR>
	Write	HDMI 2(MHL2)	<CR>*sour=hdmi2#<CR>
	Write	HDMI 3	<CR>*sour=hdmi3#<CR>
	Read	Current source	<CR>*sour=?#<CR>
Audio Control	Write	Mute On	<CR>*mute=on#<CR>
	Write	Mute Off	<CR>*mute=off#<CR>
	Read	Mute Status	<CR>*mute=?#<CR>
	Write	Volume +	<CR>*vol=+#<CR>
	Write	Volume -	<CR>*vol=-#<CR>
	Write	Volume level for customer	<CR>*vol=value#<CR>
Picture Mode	Read	Volume Status	<CR>*vol=?#<CR>
	Write	Bright	<CR>*appmod=bright#<CR>
	Write	Living Room	<CR>*appmod=livingroom#<CR>
	Write	Game	<CR>*appmod=game#<CR>
	Write	Cinema	<CR>*appmod=cine#<CR>
	Write	User1	<CR>*appmod=user1#<CR>
	Write	Sport	<CR>*appmod=sport#<CR>
Picture Setting	Read	Picture Mode	<CR>*appmod=?#<CR>
	Write	Set Contrast value	<CR>*con=value#<CR>
	Read	Contrast value	<CR>*con=?#<CR>
	Write	Brightness +	<CR>*bri=+#<CR>
	Write	Brightness -	<CR>*bri=-#<CR>
	Write	Set Brightness value	<CR>*bri=value#<CR>
	Read	Brightness value	<CR>*bri=?#<CR>
	Write	Set Color value	<CR>*color=value#<CR>
	Read	Color value	<CR>*color=?#<CR>
	Write	Set Sharpness value	<CR>*sharp=value#<CR>
	Read	Sharpness value	<CR>*sharp=?#<CR>
	Write	Color Temperature-Warm	<CR>*ct=warm#<CR>
	Write	Color Temperature-Normal	<CR>*ct=normal#<CR>
	Write	Color Temperature-Cool	<CR>*ct=cool#<CR>
	Write	Color Temperature-lamp native	<CR>*ct=ative#<CR>
	Read	Color Temperature Status	<CR>*ct=?#<CR>
	Write	Aspect 4:3	<CR>*asp=4:3#<CR>
	Write	Aspect 16:9	<CR>*asp=16:9#<CR>
	Write	Aspect Auto	<CR>*asp=AUTO#<CR>
	Read	Aspect Status	<CR>*asp=?#<CR>
Write	Vertical Keystone +	<CR>*vkeystone=+#<CR>	
Write	Vertical Keystone -	<CR>*vkeystone=-#<CR>	

Picture Setting (Continued)	Read	Vertical Keystone value	<CR>*vkeystone=?#<CR>
	Write	Horizontal Keystone +	<CR>*hkeystone=+#<CR>
	Write	Horizontal Keystone -	<CR>*hkeystone=-#<CR>
	Read	Horizontal Keystone value	<CR>*hkeystone=?#<CR>
	Write	Brilliant color on	<CR>*BC=on#<CR>
	Write	Brilliant color off	<CR>*BC=off#<CR>
	Read	Brilliant color status	<CR>*BC=?#<CR>
	Write	Reset current picture settings	<CR>*rstcurpicsetting#<CR>
	Write	Reset all picture settings	<CR>*rstallpicsetting#<CR>
Operation Settings	Write	Projector Position-Front Table	<CR>*pp=FT#<CR>
	Write	Projector Position-Rear Table	<CR>*pp=RE#<CR>
	Write	Projector Position-Rear Ceiling	<CR>*pp=RC#<CR>
	Write	Projector Position-Front Ceiling	<CR>*pp=FC#<CR>
	Read	Projector Position Status	<CR>*pp=?#<CR>
	Write	Menu Position - Center	<CR>*menuposition=center#<CR>
	Write	Menu Position - Top-Left	<CR>*menuposition=tl#<CR>
	Write	Menu Position - Top-Right	<CR>*menuposition=tr#<CR>
	Write	Menu Position - Bottom-Right	<CR>*menuposition=br#<CR>
	Write	Menu Position - Bottom-Left	<CR>*menuposition=bl#<CR>
	Read	Menu Position Status	<CR>*menuposition=?#<CR>
	Write	Direct Power On-on	<CR>*directpower=on#<CR>
	Write	Direct Power On-off	<CR>*directpower=off#<CR>
Read	Direct Power On-Status	<CR>*directpower=?#<CR>	
Baud Rate	Write	9600	<CR>*baud=9600#<CR>
	Write	14400	<CR>*baud=14400#<CR>
	Write	19200	<CR>*baud=19200#<CR>
	Write	38400	<CR>*baud=38400#<CR>
	Write	57600	<CR>*baud=57600#<CR>
	Write	115200	<CR>*baud=115200#<CR>
	Read	Current Baud Rate	<CR>*baud=?#<CR>
Lamp Control	Read	Lamp	<CR>*ltim=?#<CR>
	Write	Normal mode	<CR>*lampm=lnor#<CR>
	Write	Eco mode	<CR>*lampm=eco#<CR>
	Write	SmartEco mode	<CR>*lampm=seco#<CR>
	Write	SmartEco mode 2	<CR>*lampm= seco2#<CR>
	Read	Lamp Mode Status	<CR>*lampm=?#<CR>
Miscellaneous	Read	Model Name	<CR>*modelname=?#<CR>
	Read	System F/W Version	<CR>*sysfwversion=?#<CR>
	Read	Scaler F/W Version	<CR>*scalerfwversion=?#<CR>
	Read	MCU F/W Version	<CR>*mcutfwversion=?#<CR>
	Write	Blank On	<CR>*blank=on#<CR>
	Write	Blank Off	<CR>*blank=off#<CR>
	Read	Blank Status	<CR>*blank=?#<CR>
	Write	Freeze On	<CR>*freeze=on#<CR>
	Write	Freeze Off	<CR>*freeze=off#<CR>
	Read	Freeze Status	<CR>*freeze=?#<CR>
	Write	Menu On	<CR>*menu=on#<CR>
	Write	Menu Off	<CR>*menu=off#<CR>
	Read	Menu Status	<CR>*menu=?#<CR>
	Write	Up	<CR>*up#<CR>
	Write	Down	<CR>*down#<CR>
	Write	Right	<CR>*right#<CR>
	Write	Left	<CR>*left#<CR>
	Write	Enter	<CR>*enter#<CR>
	Write	Back	<CR>*back#<CR>
	Write	Source Menu On	<CR>*sourmenu=on#<CR>
Write	Source Menu Off	<CR>*sourmenu=off#<CR>	

Miscellaneous (Continued)	Read	Source Menu Status	<CR>*sourmenu=?#<CR>
	Write	3D Sync Off	<CR>*3d=off#<CR>
	Write	3D Sync Frame Sequential	<CR>*3d=fs#<CR>
	Read	3D Sync Status	<CR>*3d=?#<CR>
	Write	High Altitude mode on	<CR>*Highaltitude=on#<CR>
	Write	High Altitude mode off	<CR>*Highaltitude=off#<CR>
	Read	High Altitude mode status	<CR>*Highaltitude=?#<CR>
Color Calibration (only for service)	Write	Set BenQ gamma value	<CR>*gamma=value#<CR>
	Read	Gamma value status	<CR>*gamma=?#<CR>
	Write	Set HDR Brightness value	<CR>*hdrbri=value#<CR>
	Read	Get HDR Brightness value	<CR>*hdrbri=?#<CR>
	Write	Set Red Gain value	<CR>*RGain=value#<CR>
	Read	Get Red Gain value	<CR>*RGain=?#<CR>
	Write	Set Green Gain value	<CR>*GGain=value#<CR>
	Read	Get Green Gain value	<CR>*GGain=?#<CR>
	Write	Set Blue Gain value	<CR>*BGain=value#<CR>
	Read	Get Blue Gain value	<CR>*BGain=?#<CR>
	Write	Set Red Offset value	<CR>*ROffset=value#<CR>
	Read	Get Red Offset value	<CR>*ROffset=?#<CR>
	Write	Set Green Offset value	<CR>*GOffset=value#<CR>
	Read	Get Green Offset value	<CR>*GOffset=?#<CR>
	Write	Set Blue Offset value	<CR>*BOffset=value#<CR>
	Read	Get Blue Offset value	<CR>*BOffset=?#<CR>
	Write	Primary Color	<CR>*primcr=value#<CR>
	Read	Primary Color Status	<CR>*primcr=?#<CR>
	Write	Set Hue value	<CR>*hue=value#<CR>
	Read	Get Hue value	<CR>*hue=?#<CR>
	Write	Set Saturation value	<CR>*saturation =value#<CR>
Read	Get Saturation value	<CR>*saturation =?#<CR>	
Write	Set Gain value	<CR>*gain=value#<CR>	
Read	Get Gain value	<CR>*gain=?#<CR>	
Service (Only for service)	Write	Service mode enable for error report	<CR>*error=enable#<CR>
	Read	Error code report	<CR>*error=report#<CR>
	Read	FAN 1 speed	<CR>*fan1=?#<CR>
	Read	FAN 2 speed	<CR>*fan2=?#<CR>
	Read	FAN 3 speed	<CR>*fan3=?#<CR>
	Read	Temperature 1	<CR>*tmp1=?#<CR>
	Read	LED indicator	<CR>*led=?#<CR>