

# Jabra PanaCast 50

## Benutzerhandbuch

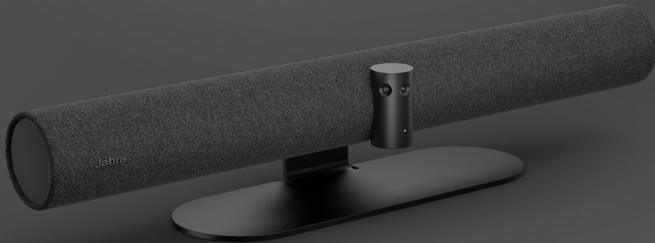

© 2021 GN Audio A/S. Alle Rechte vorbehalten. Jabra® ist ein Warenzeichen von GN Audio A/S. Die Bluetooth®-Wortmarke und -Logos sind Eigentum der Bluetooth SIG, Inc., und jegliche Benutzung dieser Marken durch GN Audio A/S erfolgt unter Lizenz.

---

Made in Malaysia

MODELL: VSM020



 **Bluetooth®**

---

**Die Konformitätserklärung** finden Sie unter [www.jabra.com/de/doc](http://www.jabra.com/de/doc)

1. Willkommen .....	5	6.3 Verkabelung von Jabra-Hub	
2. Überblick .....	6	7. Software .....	19
2.1 Überblick über die Jabra PanaCast 50		7.1 Betriebssysteme	
2.2 Enthaltene Zubehör		7.2 Jabra Direct (Windows oder macOS)	
2.3 Optionales Zubehör		7.3 Jabra Xpress (Windows oder macOS)	
3. Anzeigesignale .....	10	7.4 Jabra Sound+ (iOS oder Android)	
4. Einrichtungsanleitung .....	11	7.5 Microsoft Teams und Teams Rooms	
5. Montageoptionen.....	12	7.6 Zoom und Zoom Rooms	
5.1 Wandmontage		7.7 Weitere kompatible Anwendungen für Videokonferenzen	
5.2 Bildschirm-Wandmontage		8. Einrichten des Remote-Management .....	25
5.3 Tischmontage		8.1 Schnellstart-Assistent in Jabra Direct	
5.4 Installationshöhe		9. Videokonferenzmerkmale .....	28
6. Verkabelung.....	16	9.1 Kamerasteuerung in Jabra Direct und Jabra Sound+	
6.1 Raumverkabelung		9.2 Intelligent Zoom	
6.2 Verkabelung von Eigengeräten (Bring-Your-Own-Device – BYOD)			

9.3	Virtual Director	
9.4	Einstellen der Sicherheitskapazität	
9.5	Speichern von Voreinstellungen für Schwenken, Neigen und Zoomen	
9.6	Einstellen der Bildqualität	
9.7	Bildflimmern	
9.8	Sichtfeld	
9.9	Video-Stiching	
9.10	Firmware aktualisieren	
10.	Whiteboard .....	35
10.1	Positionieren des Whiteboards	
10.2	Einrichten der Whiteboard-Ansicht	
10.3	Whiteboard in der Hauptkamera-Ansicht freigeben	
10.4	Gesonderte Whiteboard-Ansicht in Microsoft Teams Rooms freigeben	
10.5	Gesonderte Whiteboard-Ansicht in Zoom Rooms freigeben	
11.	Fernbedienung (Option) .....	41
11.1	Koppeln der Fernbedienung	
11.2	Verwenden der Fernbedienung	
12.	Support .....	43
12.1	FAQs und technische Daten	
12.2	So pflegen Sie Ihr Jabra-Gerät	

# 1. Willkommen

Vielen Dank, dass Sie die Jabra PanaCast 50 verwenden. Wir hoffen, Sie werden Ihre Freude damit haben!

## **Jabra PanaCast 50 Leistungsmerkmale**

- **Inclusive-Meetings.** Die 4K-Panorama-Videoqualität resultiert aus drei 13-Megapixel-Kameras und einer patentierten Videobild-Zusammenführung in Echtzeit für eine 180°-Abdeckung und natürlichere Ansicht des Huddle Room.
- **Intelligente Video-Technologie.** Mit Intelligent Zoom, der alle Teilnehmer automatisch in die Konversation einbezieht, während Vivid-HDR selbst unter stark schwankenden Lichtverhältnissen für ein hervorragendes Video-Erlebnis sorgt.
- **Spontane Zusammenarbeit.** Die Plug-and-Play-Technologie ermöglicht schnelle und einfache Zusammenarbeit und bringt unkomplizierte Video- und Audiotechnologie in Ihren Huddle-Room.
- **Vielseitig kompatibel.** Kompatibel mit allen führenden Video- und Audiokonferenz-Lösungen. Für die Verwendung mit Microsoft Teams-Räume, Zoom und Zoom Rooms zertifiziert.

## 2. Überblick

### 2.1 Überblick über die Jabra PanaCast 50

---

#### VORDERSEITE

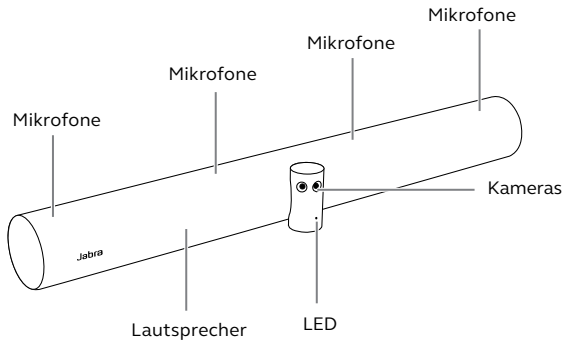

## RÜCKSEITE

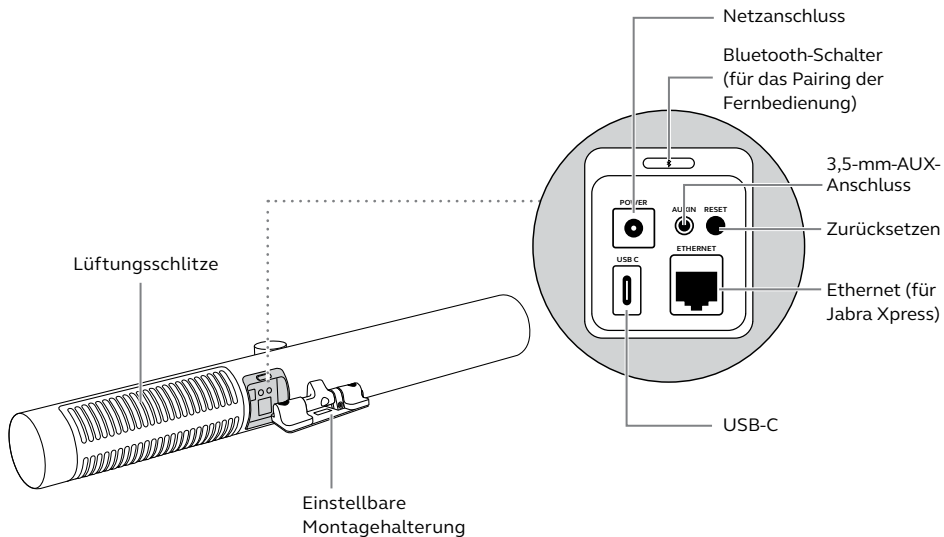

## 2.2 Enthaltenes Zubehör

---

Weiteres Zubehör kann unter [jabra.com.de/accessories](http://jabra.com.de/accessories) bestellt werden.

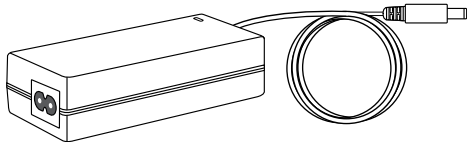

**Netzteil** (2 m)

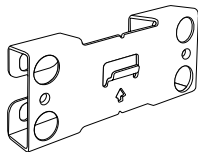

**Wandhalterung**

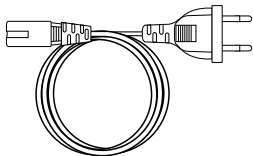

**Netzkabel**  
(1 m)

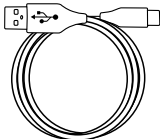

**USB-C-Kabel**  
(2 m)



**2 Schrauben**  
(M5x12)

Nicht im Lieferumfang  
enthaltene Hardware:

- Schnellbauschrauben und Dübel
- Mauerschrauben



## 2.3 Optionales Zubehör

---

Zubehör kann unter [jabra.com/accessories](https://jabra.com/accessories) erworben werden.

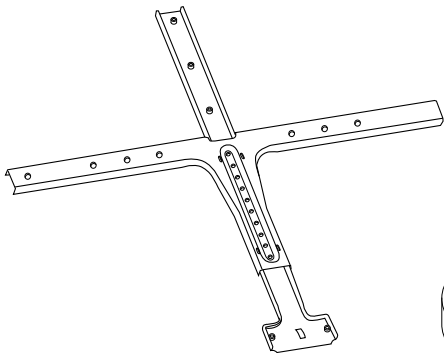

**Bildschirmhalterung**

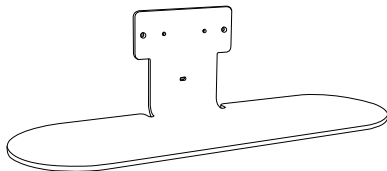

**Tischstativ**

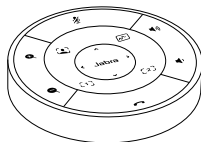

**Fernbedienung**

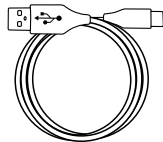

**USB-C-Kabel  
(5 m)**

### 3. Anzeigesignale

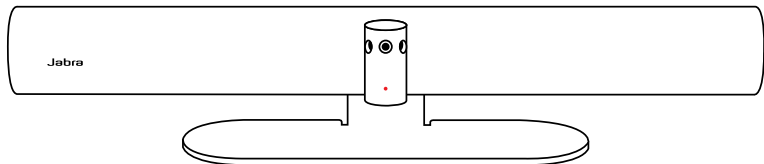

#### LED-STATUSANZEIGE

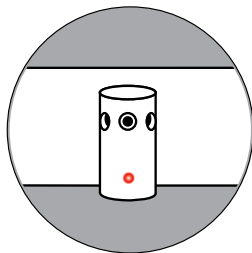

Ausgeschaltet oder nicht im Streamingmodus	(LED-Anzeige aus)
Wird gestartet	○ (blinkt weiß)
Verbindung aufgebaut	○ (3 Sek. lang zu sehen)
Gespräch läuft oder Video-/Medien-Streaming wird ausgeführt	○
Gespräch läuft, Audio stummgeschaltet	●
Benachrichtigung zur Raumebelegung	● (blinkt rot)
Pairing per Fernbedienung	● (blinkt grün und blau)
Firmware-Update	● (blinkt violett)

# 4. Einrichtungsanleitung

Die Jabra PanaCast 50 ist für Meetingräume bis zu 4,5 x 4,5 m ausgelegt und kann entweder mit der im Lieferumfang enthaltenen Wandhalterung an der Wand montiert oder mit der optionalen Bildschirm- oder Tischhalterung befestigt werden. Wenn im Meeting-Raum ein Whiteboard verwendet wird, sollte dieses idealerweise an der angrenzenden Wand positioniert sein, um den Teilnehmern eine optimale Sicht zu ermöglichen.

Hier finden Sie den Leitfaden (PDF) für die Installation im Meeting-Raum: [jabra.com/help/panacast50/getstarted](https://www.jabra.com/help/panacast50/getstarted)

Im Folgenden sind einige typische Optionen für die Installation im Meeting-Raum abgebildet:



# 5. Montageoptionen

## 5.1 Wandmontage

---

Hier können Sie sich das Video bzw. das PDF für die Wandhalterungsmontage ansehen:  
[jabra.com/help/panacast50/getstarted](https://jabra.com/help/panacast50/getstarted)

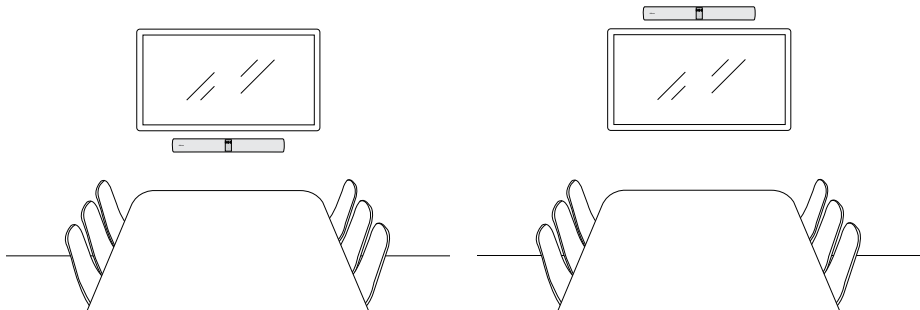

## 5.2 Bildschirm-Wandmontage

---

Hier können Sie sich das Video bzw. das PDF für die Bildschirmhalterungsmontage ansehen:  
[jabra.com/help/panacast50/getstarted](https://jabra.com/help/panacast50/getstarted)

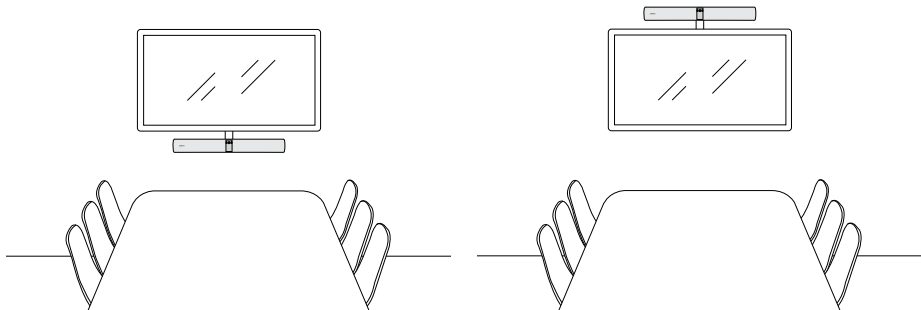

## 5.3 Tischmontage

---

Hier können Sie sich das Video bzw. das PDF für die Tischhalterungsmontage ansehen:  
[jabra.com/help/panacast50/getstarted](https://jabra.com/help/panacast50/getstarted)

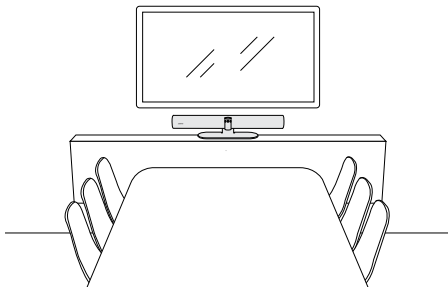

## 5.4 Installationshöhe

---

Wir empfehlen, die Jabra PanaCast 50 auf Augenhöhe der Teilnehmer im Meeting-Raum zu montieren.

Wenn Sie die PanaCast 50 mithilfe der Wandhalterung oder der Bildschirmhalterung installieren möchten, sollte die Kamera 8 cm unter dem Bildschirm und idealerweise 30-35 cm über der Tischplatte oder 100 cm über dem Boden positioniert werden. Sollte diese Höhe nicht möglich sein, empfehlen wir, die Jabra PanaCast 50 über dem Bildschirm anzubringen.

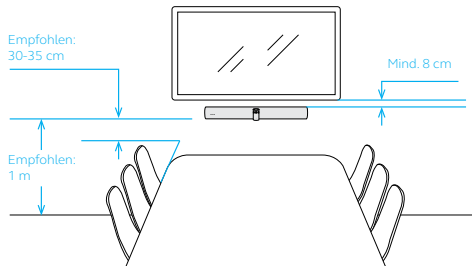

Setzen Sie die Kamera nicht direkter Sonneneinstrahlung aus, da dies den voreingestellten Weißabgleich und das Bild beeinträchtigen könnte.

# 6. Verkabelung

Die Jabra PanaCast 50 ist vielfältig einsetzbar und kann mit einem Microsoft Teams-Raum oder Zoom Rooms-Systemen, privaten Endgeräten (BYOD, Bring-your-own-devices) oder mit einem Jabra-Hub verwendet werden.

## 6.1 Raumverkabelung

---

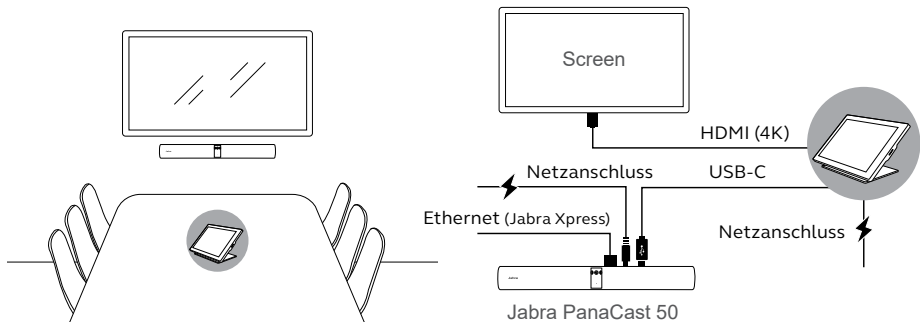



## 6.2 Verkabelung von Eigengeräten (Bring-Your-Own-Device – BYOD)

---

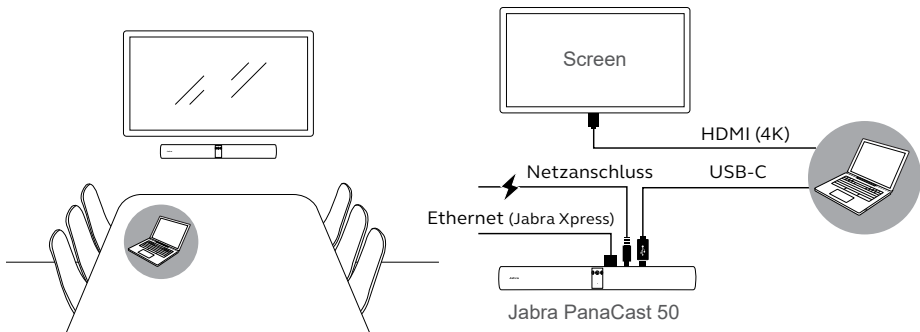

## 6.3 Verkabelung von Jabra-Hub

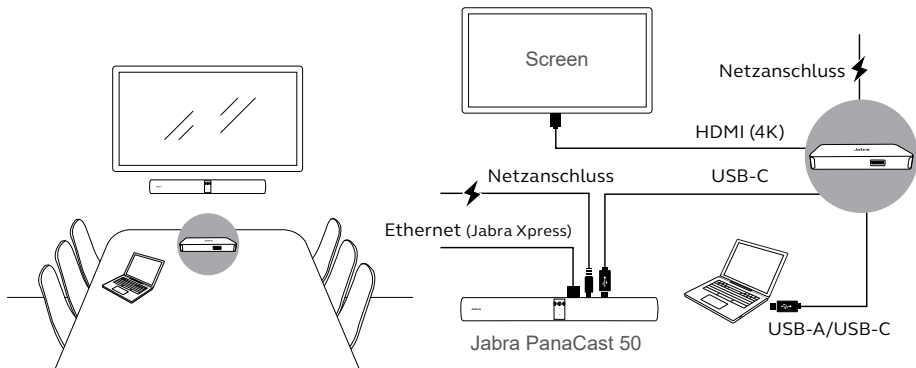

# 7. Software

## 7.1 Betriebssysteme

---

Die Jabra PanaCast 50 unterstützt Windows 8 und höher sowie macOS 10.15 und höher und benötigt keine zusätzlichen Treiber.

## 7.2 Jabra Direct (Windows oder macOS)

---

Jabra Direct ist eine kostenfreie Desktop-Software zur Unterstützung, Verwaltung und Umsetzung der optimalen Funktionalität von Jabra-Geräten. Jabra Direct verfügt über einen Camera Controller, der als Fernbedienung für die Jabra PanaCast 50 verwendet werden kann (weitere Informationen hierzu finden Sie in Abschnitt 9.1).

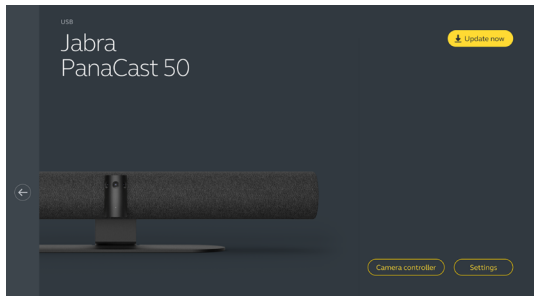

Die neueste, kostenfreie Version finden Sie auf [jabra.com/direct](https://jabra.com/direct)

## 7.3 Jabra Xpress (Windows oder macOS)

---

Jabra Xpress ist eine kostenfreie Desktop-Software zur Breitereinführung und Verwaltung mehrerer Jabra-Geräte in einer Organisation. Jabra Xpress kann die Raumbellegungsgrenzen nachverfolgen und detaillierte Einblicke zur Gerätenutzung bereitstellen.

Besuchen Sie [jabra.com.de/xpress](https://jabra.com.de/xpress), um Zugang zu Jabra Xpress zu erhalten

## 7.4 Jabra Sound+ (iOS oder Android)

Jabra Sound+ ist eine kostenlose App für iOS- oder Android-Smartphones, die als Fernbedienung für die Jabra PanaCast 50 verwendet werden kann.

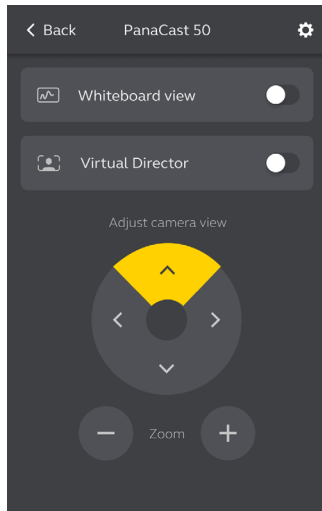

## 7.5 Microsoft Teams und Teams Rooms

---

Microsoft Teams oder Microsoft Teams-Räume erkennt die Jabra PanaCast 50 automatisch und legt sie als standardmäßiges Video- und Audiogerät fest.

Gehen Sie wie folgt vor, um die Jabra PanaCast 50 manuell als das standardmäßige Video- und Audiogerät für Microsoft Teams oder Teams-Räume festzulegen:

1. Starten Sie Microsoft Teams oder Microsoft Teams-Räume.
2. Klicken Sie auf Ihr Account-Profil-Symbol in der rechten, oberen Ecke von Microsoft Teams.
3. Wählen Sie **Einstellungen**, um das Einstellungsmenü zu öffnen.
4. Wählen Sie den **Geräte**-Tab in der Menüliste.
5. Wählen Sie unter **Kamera** (Camera) und **Audiogeräte** (Audio devices) die **Jabra PanaCast 50** aus.

Wenn Sie weitere Hilfe benötigen, wenden Sie sich an das Helpcenter von Microsoft Teams.

## 7.6 Zoom und Zoom Rooms

---

Zoom oder Zoom Rooms erkennt die Jabra PanaCast 50 automatisch und legt sie als standardmäßiges Video- und Audiogerät fest.

Gehen Sie wie folgt vor, um die Jabra PanaCast 50 manuell als das standardmäßige Video- und Audiogerät in Zoom oder Zoom Rooms festzulegen:

1. Starten Sie Zoom oder Zoom Rooms.
2. Klicken Sie in der Zoom-Anwendung oben rechts auf das Rad-Symbol, um das Einstellungsmenü zu öffnen.
3. Wählen Sie in den Registerkarten **Video** und **Audio** die **Jabra PanaCast 50** als Kamera und Lautsprecher aus.

Wenn Sie weitere Hilfe benötigen, wenden Sie sich an das Helpcenter von Zoom.

## 7.7 Weitere kompatible Anwendungen für Videokonferenzen

---

Wenn Sie die Jabra PanaCast 50 mit anderen kompatiblen Videokonferenz-Anwendungen verwenden möchten, sollten Sie sich vergewissern, dass die Kamera in den Video-/Audioeinstellungen für die Videokonferenz-Anwendung manuell als Standardvideo- und -audiogerät festgelegt wurde.



# 8. Einrichten des Remote-Management

Die Jabra PanaCast 50 kann über Jabra Xpress und eine Ethernet-Verbindung remote verwaltet werden, ohne dass Sie dafür Jabra Direct benötigen oder sich mit einem Computer verbinden müssen. Das bedeutet, dass die Jabra PanaCast 50 automatisch verwaltete Einstellungen anwendet und stets mit der ausgewählten Firmware aktualisiert wird.

## 8.1 Schnellstart-Assistent in Jabra Direct

---

Wenn Sie die Jabra PanaCast 50 das erste Mal an einen Computer anschließen, auf dem Jabra Direct installiert ist, wird automatisch ein Quick Start-Assistent gestartet. Dieser Assistent richtet die Jabra PanaCast 50 so ein, dass sie über Xpress remote verwaltet werden kann. Außerdem führt er Sie durch die Schritte zur Benennung Ihres Geräts, zur Aktivierung der Xpress-Verwaltung über eine Ethernet-Verbindung und zur Verbindung mit einer gültigen Xpress-Paket-URL. Als zusätzliche Schutzebene für die Einstellungen der Jabra PanaCast 50 kann ein Passwort erstellt werden.

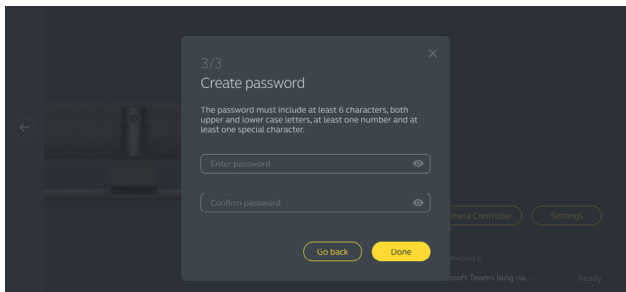
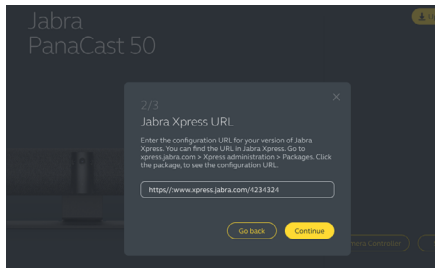
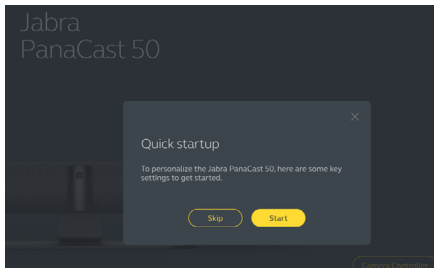

Sie können die Einstellungen für den Quick Start-Assistenten jederzeit über Jabra Direct ändern.

1. Starten Sie Jabra Direct und prüfen Sie, ob die Jabra PanaCast 50 ausgewählt ist.
2. Wählen Sie **Einstellungen**, um das Einstellungsmenü zu öffnen.
3. Ändern Sie die entsprechenden Einstellungen für das Remote-Management von Jabra Xpress.
4. Drücken Sie auf **Speichern** (Save), um die Änderungen auf die Jabra PanaCast 50 anzuwenden. Daraufhin startet die Jabra PanaCast 50 neu und die Änderungen werden wirksam.

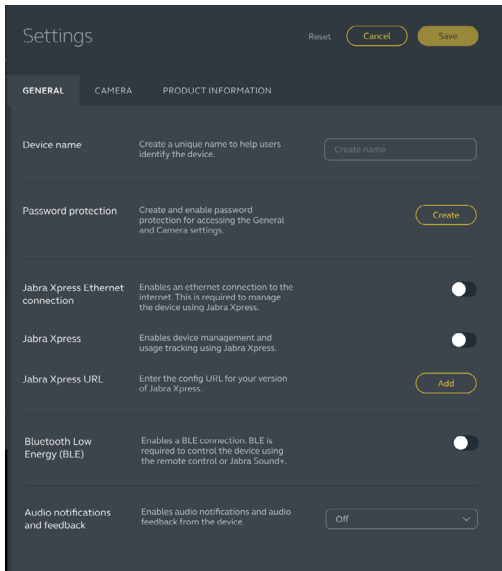

# 9. Videokonferenzmerkmale

## 9.1 Kamerasteuerung in Jabra Direct und Jabra Sound+

---

Der Camera Controller ist ein Tool in Jabra Direct und Jabra Sound+, mit dem Nutzer die Jabra PanaCast 50 über einen Computer, ein Smartphone oder ein Tablet fernsteuern können.

Der Camera Controller bietet den Nutzern folgende Möglichkeiten:

- Verwendung von automatischen Zoom-Modi (Virtual Director oder Intelligenter Zoom).
- Einrichten und Teilen eines Whiteboards.
- Anpassung der Kameraansicht anhand von Pan-Tilt-Zoom-Steuerungen.
- Anpassung der Einstellungen für die Bildqualität (z. B. Helligkeit, Sättigung etc.)
- Auswahl und Anpassung von Voreinstellungen an persönliche Anforderungen.

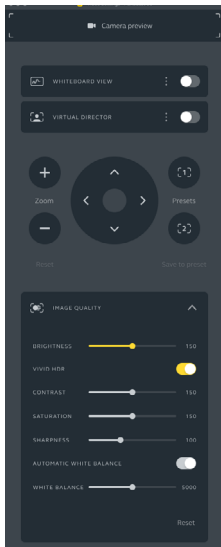

Jabra Direct Camera Controller

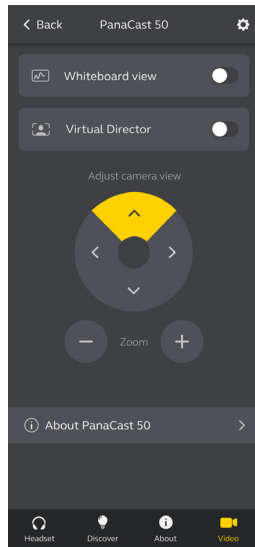

Jabra Sound+ Camera Controller

## 9.2 Intelligent Zoom

---

„Intelligenter Zoom“ ist ein automatischer Zoom-Modus, der auf dynamische Weise alle sichtbaren Personen im Umkreis von 3,5 m miteinbezieht.

Die Nutzer können über den Camera Controller in Jabra Direct, Jabra Sound+ oder durch Verwendung der Fernbedienung auf die Funktion „Intelligenter Zoom“ zugreifen. Es kann immer nur ein automatischer Zoom-Modus zu einem gegebenen Zeitpunkt aktiv sein.

Der **Automatische Zoommodus** (Automatic zoom mode) ist standardmäßig auf „Intelligenter Zoom“ (Intelligent Zoom) eingestellt.

## 9.3 Virtual Director

---

„Virtual Director“ ist ein automatischer Zoom-Modus mit Sprecher-Erkennung, d. h., mit Fokussierung auf die Person in der Kameraansicht, die gerade spricht.

Die Nutzer können über den Camera Controller in Jabra Direct oder Jabra Sound+ auf „Virtual Director“ zugreifen. Es kann immer nur ein automatischer Zoom-Modus zu einem gegebenen Zeitpunkt aktiv sein.

Der **Automatische Zoommodus** (Automatic zoom mode) ist standardmäßig auf „Intelligenter Zoom“ (Intelligent Zoom) eingestellt, kann aber auf „Virtual Director“ geändert werden.

## 9.4 Einstellen der Sicherheitskapazität

---

Wenn Sie Jabra Direct verwenden, können Sie eine Belegungsgrenze für einen Meeting-Raum festlegen. Wenn eine solche Belegungsgrenze bestimmt wurde, erkennt die Jabra PanaCast 50 anhand der PeopleCount-Technologie automatisch eine Überschreitung der zulässigen Höchstanzahl von Personen im Meeting-Raum und kann eine Warnung in Echtzeit ausgeben. Diese anonymen PeopleCount-Daten können mit Jabra Xpress nachverfolgt und verwaltet werden.

Die PeopleCount-Technologie erkennt Köpfe und Körper von Personen, die sich in einem Abstand von 1-4 Metern zur Kamera befinden und gut zu sehen sind, mit einer Genauigkeit von über 75 %.

Die Benachrichtigungen zur **Raumbelegung** (Safety capacity notifications) sind standardmäßig ausgeschaltet. Sie können diese Einstellung über Jabra Direct konfigurieren und die Daten mit Jabra Xpress nachverfolgen und verwalten.

## 9.5 Speichern von Voreinstellungen für Schwenken, Neigen und Zoomen

---

Die Pan-Tilt-Zoom-Voreinstellungen ermöglichen es den Nutzern, die Kameraansicht über den Camera Controller in Jabra Direct, Jabra Sound+ oder über die Fernbedienung anzupassen und zu speichern. Die gespeicherten Voreinstellungen überschreiben nicht die standardmäßigen Pan-Tilt-Zoom-Einstellungen. Die Nutzer können die gespeicherten Voreinstellungen zu Beginn eines neuen Meetings auswählen.

Die Berechtigungen für die Bearbeitung von Voreinstellungen können in Jabra Direct gesperrt werden.

## 9.6 Einstellen der Bildqualität

---

Die Einstellungen zu Bildhelligkeit, Kontrast, Sättigung, Bildschärfe und zum Weißabgleich können anhand des Camera Controller in Jabra Direct oder Jabra Sound+ angepasst werden.

Darüber hinaus haben Sie die Möglichkeit, die Funktionen „Vivid HDR“ und „Automatischer Weißabgleich“ (Automatic white balance) zu aktivieren. Wenn Vivid HDR aktiviert ist, können der Kontrast, die Sättigung und die Schärfe nicht manuell geändert werden. Wenn der automatische Weißabgleich aktiviert ist, kann der Weißabgleich nicht manuell geändert werden.



## 9.7 Bildflimmern

---

Videoflimmern kann auftreten, wenn die Jabra PanaCast 50 nicht auf die korrekte geographische Region eingestellt ist. Um das Videoflimmern zu vermeiden, wählen Sie in Regionen, in denen das NTSC-Format unterstützt wird, „Automatisch“ (Auto) (50 Hz/60 Hz) aus. In Regionen, in denen das PAL-Format unterstützt wird, wählen Sie 50 Hz aus.

Die Standardeinstellung für **Videoflimmern** (Video flicker) ist „Automatisch“ (Auto). Diese Einstellung kann in Jabra Direct konfiguriert werden.

## 9.8 Sichtfeld

---

Der Kamerawinkel kann optisch angepasst werden, um eine breitere oder schmalere Ansicht des Meeting-Raums zu erhalten.

Die Standardeinstellung für **Sichtfeld** (Field of view) ist ein Winkel von 180°. Diese Einstellung kann in Jabra Direct angepasst werden.

## 9.9 Video-Stiching

---

Für eine 180°-Kameraansicht wird die Videostitching-Technologie eingesetzt, um überlappende Videobereiche zu verbinden. Videostitching funktioniert am besten bei einer Entfernung zur Kamera zwischen 60 cm und 5 m.

Die Jabra PanaCast 50 verfügt über zwei Videostitching-Methoden: „Mischen“ (Blend) und „Hybrid“.

## 9.10 Firmware aktualisieren

---

Firmware-Updates verbessern die Leistung oder erweitern die Jabra-Geräte um neue Funktionen. Jabra Direct muss die Firmware der Jabra PanaCast 50 aktualisieren.

Wenn ein Firmware-Update verfügbar ist, werden Sie benachrichtigt, sobald die Jabra PanaCast 50 an einen Computer angeschlossen wird, auf dem Jabra Direct installiert ist.

# 10. Whiteboard

Dank des 180°-Sichtfelds der Jabra PanaCast 50 können Sie die Inhalte auf Ihrem Whiteboard in Echtzeit teilen, selbst wenn das Whiteboard im spitzen Winkel zur Kamera positioniert ist. Die intelligente Software korrigiert automatisch die Perspektive und garantiert so bestmögliche Sichtbarkeit. Zugleich optimiert sie die Bildqualität in Echtzeit, indem sie zu helle, zu dunkle oder spiegelnde Bereiche anpasst und die Farbe sowie den Kontrast von Textmarkern intensiviert. Dank des Kamera-Streams für sekundäre Inhalte können Sie sowohl das Whiteboard als auch die Teilnehmenden gleichzeitig anzeigen lassen.

Wir empfehlen die Verwendung eines Whiteboards mit einer Breite zwischen 1,5 und 2,7 Metern; es werden jedoch alle Whiteboards mit einer Breite zwischen 1 und 3 Metern unterstützt.

## 10.1 Positionieren des Whiteboards

---

Wir empfehlen, das Whiteboard in einer Entfernung von nicht mehr als 3,6 m zur Jabra PanaCast 50 zu positionieren, und nicht näher als 1,5 m. Der optimale Sichtbereich beträgt 3 Meter.

Bitte beachten Sie, dass die Jabra PanaCast 50-Kamera drei separate Linsen umfasst, die horizontal angeordnet sind. Das Whiteboard MUSS komplett innerhalb des Sichtfelds einer dieser drei Linsen positioniert werden.

Wir empfehlen, ein Standard-Whiteboard zu verwenden, und keine stark reflektierende oder Glasoberfläche. Für eine besonders klare Darstellung sollten schwarze oder dunkle Textmarker zum Schreiben auf dem Whiteboard verwendet werden.

## 10.2 Einrichten der Whiteboard-Ansicht

---

Bevor das Whiteboard in einer Videokonferenz freigegeben werden kann, muss zuerst in Jabra Direct eine Whiteboard-Ansicht eingerichtet werden.

Hierfür rufen Sie **Whiteboard-Ansicht einrichten** (Whiteboard view setup) in den Einstellungen für die **Kamera** (Camera) in Jabra Direct auf und klicken dann auf **Einrichten (Set up)**. Jabra Direct führt Sie durch den Vorgang für das Einrichten einer Whiteboard-Ansicht.

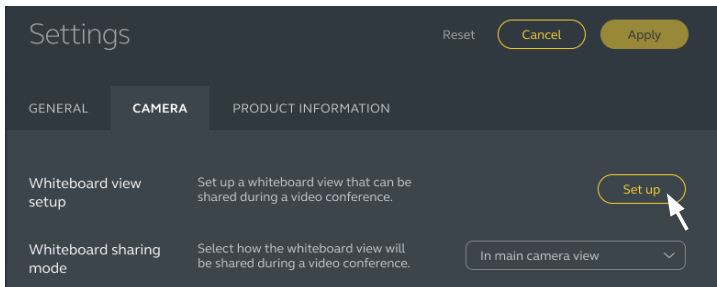

## 10.3 Whiteboard in der Hauptkamera-Ansicht freigeben

Wenn der **Whiteboard-Freigabemodus** (Whiteboard sharing mode) in Jabra Direct auf „Hauptkameraansicht“ (Main camera view) eingestellt ist, können Sie durch Ein-/Ausschalten der Whiteboard-Ansicht mithilfe des Camera Controller in Jabra Direct oder Jabra Sound+ oder über die Fernbedienung zwischen der Meeting-Ansicht und der Whiteboard-Ansicht wechseln.

Die Standardeinstellung für den **Whiteboard-Freigabemodus** (Whiteboard sharing mode) in Jabra Direct ist die Hauptkameraansicht (Main camera view). Diese Einstellung kann in Jabra Direct konfiguriert werden.

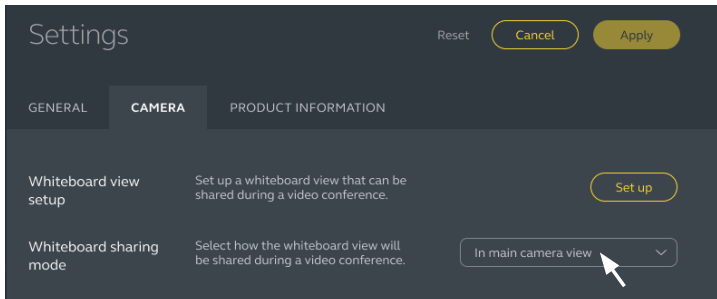

## 10.4 Gesonderte Whiteboard-Ansicht in Microsoft Teams Rooms freigeben

---

Die Whiteboard-Ansicht kann in Microsoft Teams-Räume als separate Inhaltskameraansicht freigegeben werden. Dadurch öffnet sich ein eigener Videostream, in dem das Whiteboard zu sehen ist.

1. Starten Sie Jabra Direct und prüfen Sie, ob die Jabra PanaCast 50 ausgewählt ist.
2. Wählen Sie **Einstellungen**, um das Einstellungsmenü zu öffnen.
3. Wählen Sie die Registerkarte **Kamera** (Camera) aus.
4. Legen Sie den **Whiteboard-Freigabemodus** (Whiteboard sharing mode) als **In separater Inhaltskameraansicht (In separate content camera view) fest**.
5. Starten Sie Microsoft Teams-Raum.
6. Wählen Sie **Einstellungen**, um das Einstellungsmenü zu öffnen.
7. Wählen Sie den **Geräte**-Tab in der Menüliste.
8. Wählen Sie unter **Kamera-Standard Einstellungen** (Camera Defaults) **Jabra PanaCast 50 Inhaltskamera** (Jabra PanaCast 50 Content Camera) als Inhaltskamera aus und vergewissern Sie sich, dass die Option **Inhaltsverbesserungen** (Content enhancements) ausgewählt ist.

## 10.5 Gesonderte Whiteboard-Ansicht in Zoom Rooms freigeben

---

Die Whiteboard-Ansicht kann in Zoom Rooms als separate Inhaltskameraansicht freigegeben werden. Dadurch öffnet sich ein eigener Videostream, in dem das Whiteboard zu sehen ist.

1. Starten Sie Jabra Direct und prüfen Sie, ob die Jabra PanaCast 50 ausgewählt ist.
2. Wählen Sie **Einstellungen**, um das Einstellungsmenü zu öffnen.
3. Wählen Sie die Registerkarte **Kamera** (Camera) aus.
4. Legen Sie den **Whiteboard-Freigabemodus** (Whiteboard sharing mode) als **In separater Inhaltskameraansicht (In separate content camera view) fest**.
5. Starten Sie Zoom Rooms.
6. Klicken Sie auf Ihr Account-Profilsymbol in der rechten oberen Ecke von Zoom.
7. Wählen Sie **Einstellungen**, um das Einstellungsmenü zu öffnen.
8. Wählen Sie in der Registerkarte **Video** die **Jabra PanaCast 50 Inhaltskamera** (Jabra PanaCast 50 Content Camera) als Inhaltskamera aus.



# 11. Fernbedienung (Option)

## 11.1 Koppeln der Fernbedienung

---

1. Halten Sie die Bluetooth-Taste an der Rückseite der Jabra PanaCast 50 5 Sekunden lang gedrückt, bis die LED-Anzeige an der Kamera blau und grün blinkt. Dadurch wird angezeigt, dass sich die Jabra PanaCast 50 im Pairing-Modus befindet.
2. Halten Sie die Stummschalte-Taste an der Fernbedienung 5 Sekunden lang gedrückt, bis die Jabra PanaCast 50 eine Audiobenachrichtigung ausgibt. Dadurch wird angezeigt, dass das Pairing zwischen Fernbedienung und Jabra PanaCast 50 abgeschlossen ist.

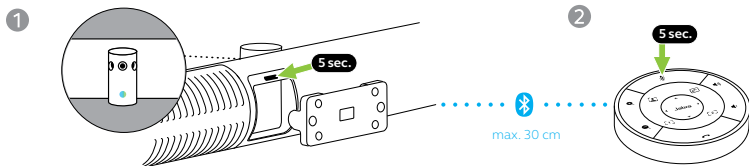

Die Fernbedienung muss sich für das Pairing innerhalb eines Abstands von 30 cm von der Jabra PanaCast 50 befinden.

## 11.2 Verwenden der Fernbedienung

Der Funktionsbereich der Fernbedienung beträgt 10 Meter.

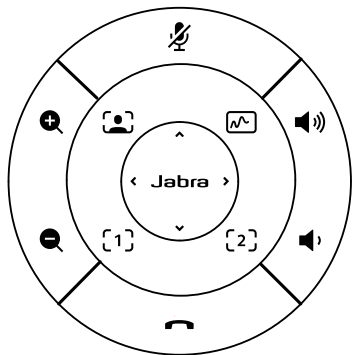

Mikrofon-Stumm-/lautschaltung  
Pairing mit PanaCast 50 (*halten*)



Intelligenten Zoom ein-/ausschalten



Whiteboard-Ansicht ein-/ausschalten



Voreinstellung 1 auswählen  
Voreinstellung 1 speichern (*halten*)



Voreinstellung 2 auswählen  
Voreinstellung 2 speichern (*halten*)



Kameraansicht anpassen



Anruf beenden



Vergrößern



Verkleinern



Lautstärke (+)



Lautstärke (-)

# 12.Support

## 12.1 FAQs und technische Daten

---

Die FAQs, Zertifizierungen und technischen Daten finden Sie unter [jabra.com.de/help/panacast50](https://jabra.com.de/help/panacast50)

## 12.2 So pflegen Sie Ihr Jabra-Gerät

---

- Die Jabra PanaCast 50 ist nicht für den Gebrauch im Freien geeignet.
- Vermeiden Sie direkte Sonneneinstrahlung und Temperaturen über 30 °C bzw. unter 0 °C.
- Schützen Sie das Headset bzw. die Basisstation vor Regenwasser und Flüssigkeiten.
- Positionieren Sie die Kamera nicht in der Nähe der Belüftungsöffnungen eines Monitors oder TVs, da dies zu einer Überhitzung und Fehlfunktionen der Kamera führen kann.
- Reinigen Sie die Stoffoberfläche mit einem Tuch, das mit einer milden Seifenlösung angefeuchtet ist.