

User's Guide

ELMO Wireless Pen Tablet (CRA-2)

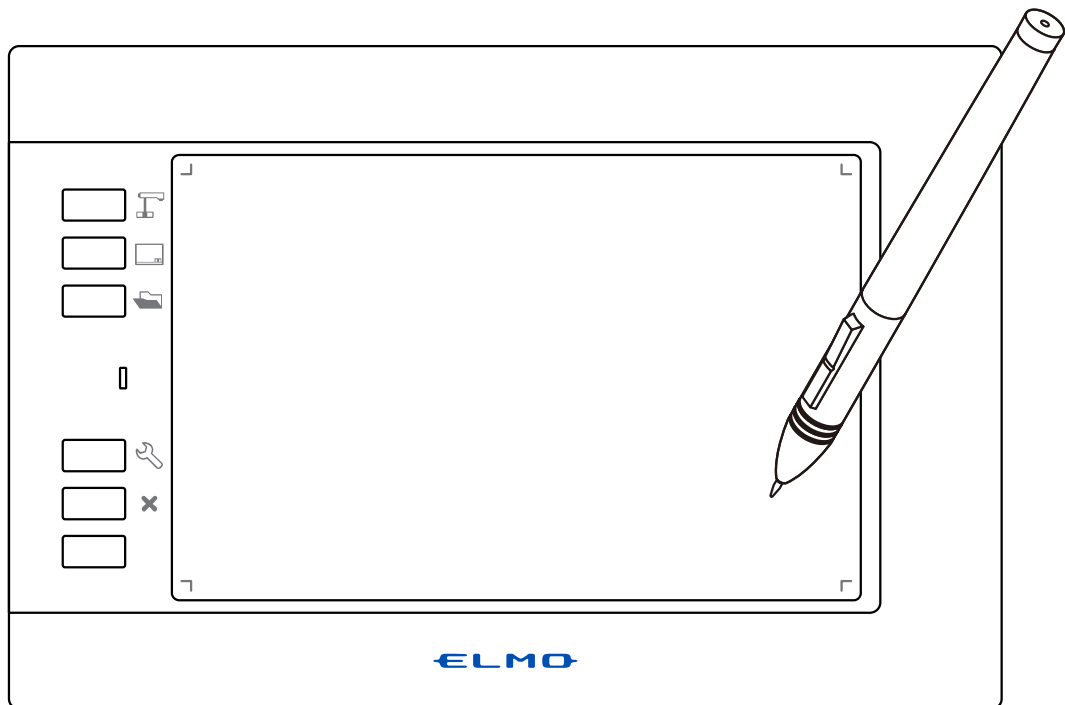

Read this User's Guide carefully before using the CRA-2.

Store this User's Guide in a safe place in case you need it again.

IMPORTANT SAFETY INSTRUCTIONS

- 1) Read these instructions.
- 2) Keep these instructions.
- 3) Heed all warnings.
- 4) Follow all instructions.
- 5) Do not use this apparatus near water.
- 6) Clean only with dry cloth.
- 7) Do not block any ventilation openings, Install in accordance with the manufacturer's instructions.
- 8) Do not install near any heat sources such as radiators, heat registers, stoves, or other apparatus (including amplifiers) that produce heat.
- 9) Do not defeat the safety purpose of the polarized or grounding-type plug. A polarized plug has two blades with one wider than the other. A grounding type plug has two blades and a third grounding prong. The wide blade or the third prong are provided for your safety. If the provided plug does not fit into your outlet, consult an electrician for replacement of the obsolete outlet.
- 10) Protect the power cord from being walked on or pinched particularly at

plugs, convenience receptacles, and the point where they exit from the apparatus.

11) Only use attachments/accessories specified by the manufacturer.

12) Use only with the cart, stand, tripod, bracket, or table

specified by the manufacturer, or sold with the apparatus.

When a cart is used, use caution when moving the cart/apparatus combination to avoid injury from tip-over.



13) Unplug this apparatus during lightning storms or when unused for long periods of time.

14) Refer all servicing to qualified service personnel. Servicing is required when the apparatus has been damaged in any way, such as power-supply cord or plug is damaged, liquid has been spilled or objects have fallen into the apparatus, the apparatus has been exposed to rain or moisture, does not operate normally, or has been dropped.



SA 1965



SA 1966

The lightning flash with arrowhead symbol, within an equilateral triangle, is intended to alert the user to the presence of uninsulated "dangerous voltage" within the product's enclosure that may be of sufficient magnitude to constitute a risk of electric shock to persons. This marking is located at the bottom of product.

The exclamation point within an equilateral triangle is intended to alert the user to the presence of important operating and maintenance (servicing) instructions in the literature accompanying the product.

WARNING:
TO REDUCE THE RISK OF FIRE OR ELECTRIC SHOCK, DO NOT EXPOSE THIS PRODUCT TO RAIN OR MOISTURE.

WARNING:

Handling the cord on this product or cords associated with accessories sold with this product, will expose you to lead, a chemical known to the State of California to cause birth defects or other reproductive harm. Wash hands after handling.

NOTICE:

This device complies with Part 15 of the FCC Rules and with RSS-210 of Industry Canada. Operation is subject to the following two conditions:

- (1) this device may not cause harmful interference, and
- (2) this device must accept any interference received, including interference that may cause undesired operation.

Changes or modifications made to this equipment not expressly approved by (manufacturer name) may void the FCC authorization to operate this equipment.

This equipment has been tested and found to comply with the limits for a Class B digital device, pursuant to Part 15 of the FCC Rules. These limits are designed to provide reasonable protection against harmful interference in a residential installation. This equipment generates, uses and can radiate radio frequency energy and, if not installed and used in accordance with the instructions, may cause harmful interference to radio communications. However, there is no guarantee that interference will not occur in a particular installation. If this equipment does cause harmful interference to radio or television reception, which can be determined by turning the equipment off and on, the user is encouraged to try to correct the interference by one or more of the following measures:

- Reorient or relocate the receiving antenna.
- Increase the separation between the equipment and receiver.
- Connect the equipment into an outlet on a circuit different from that to which the receiver is connected.
- Consult the dealer or an experienced radio/TV technician for help.

Usage Precautions

■ About electric waves used by the tablet

This product uses electric waves in the 2.4 GHz band. When using the product, a radio station license is not necessary. However, please note the following precautions.

Do not use the product near the followings:

- Microwave ovens/industrial, scientific or medical equipment, such as pacemakers
- In-factory radio stations for mobile unit identification systems (radio stations that require a license) used in production lines of factories
- Specified low power radio stations (radio stations that do not require a license)
- IEEE802.11g/b wireless LAN units

When the Tablet is used near any of the equipment mentioned above, electric wave interference may occur, making the Tablet difficult to use.

■ About wireless equipment used in the 2.4 GHz band

This frequency bandwidth is the same as for industrial, scientific, and medical equipment such as microwave ovens, mobile unit identification systems (radio stations that require a license) used in factory production lines, and specified low-power radio stations (radio stations that do not require a license).

- Before using the product, check that there are no radio stations for mobile unit identification systems or specified low-power radio stations nearby.
- If the product emits electric waves which interfere with in-factory radio stations for mobile unit identification systems, cease use immediately and stop generating the electric waves. For information on countermeasures, etc. (for example, erecting partitions), contact one of our sales departments whose details are provided at the end of this manual.
- If the product emits electric waves which interfere with specified low-power radio stations used for mobile unit identification systems, or causes similar problems, contact one of our sales departments whose details are provided at the end of this manual.

■ About the operating environment and storage

- This product is for indoor use only. It cannot be used outdoors.
- Do not place the product in a damp or dusty location, in a location exposed to the sea breeze, or in an area exposed to high vibration.

The operating environment conditions are as follows.

Temperature: 0 to 40°C

Humidity: 20 to 90% (no condensation)

- Do not store in a location exposed to direct sunlight or near to heating equipment. Discoloration, deformation or malfunctions could result.

■ **Cleaning**

When cleaning the product, remove the connected USB cable and perform in a location that is not subject to humidity or moisture.

- Remove any dirt from the product with a soft, dry cloth.
- To remove stubborn dirt, dilute some detergent in water, dip a soft cloth in the water, and then wring it out before using it to wipe away the dirt. Do not use any volatile solvents such as thinner or benzene.

■ **About the battery**

The built-in lithium-ion battery has a limited life. Even within the warranty period, battery capacity will gradually decrease over time, number of uses, usage time, and temperature. If the time that can be used at room temperature (10 to 30 ° C) is significantly shortened, it is considered to be the end of life.

Disposal of the battery

The rechargeable lithium-ion battery is used for the product. It can be recycled but cannot be removed by the user. Contact the dealer from whom you purchased the product for information about how to remove the battery.

Table of Contents

Before Use	7
Main functions	8
Supplied items	9
Part names	10
Preparations	11
Charging	11
Installing the touchscreen electronic blackboard software “ELMO Interactive Toolbox (EIT)”	12
Basic tablet operations	13
Basic pen operations	13
Basic screen layout of EIT	14
How to Use	15
1. Setting up the devices (Document camera, Computer, Projector, etc.)	15
2. Turning on the tablet	16
3. Operating the tablet.....	17
Other Functions	19
Replacing the pen tip	19
Storing the pen and wireless dongle	19
About the Status LED	20
Troubleshooting	21
Product Specifications	23
Product specifications	23
Disclaimer.....	24
About trademarks	24

Before Use

Thank you very much for purchasing CRA-2.

Please read this manual carefully to make suitable use of the product. Also, please be sure to refer to any supplemental information included with this product.



Caution

- The screen images and drawings in this manual may be different from actual ones.

Main functions

■ Enhance your lessons

By wirelessly connecting the tablet to a computer after installing the application software supplied with the tablet, you can make your lessons more effective and attractive using the tablet. (⇒P.12)

■ Use with document camera and IWB

By connecting to the separately sold Elmo document camera (L-12iD / TT-12iD / L-12F / TT-12F / L-12W / TT-12W / MA-1 / MO-2), you can use the tablet without a computer.

※Depending on the model of the document camera used, some functions may not be available.

※Drawing on the tablet and the CRB-2 (IWB) cannot be performed at the same time.

Supplied items

The following items are supplied with the product. Contact your dealer if any of the following items are not included in the package you purchased.

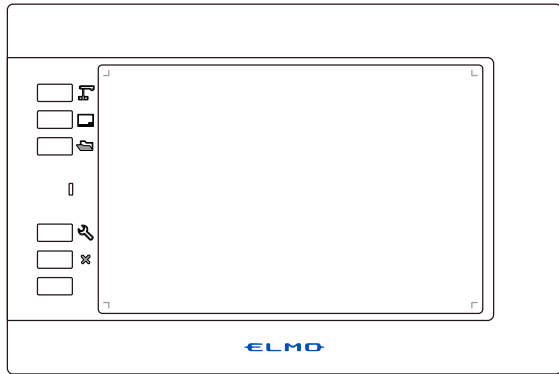

Tablet

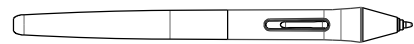

Pen

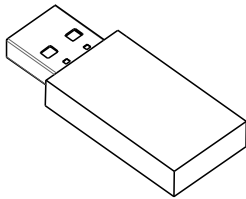

Wireless dongle

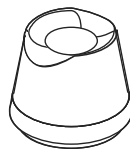

Pen holder

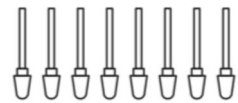

Extra core ×8
(※Stored inside the pen holder)

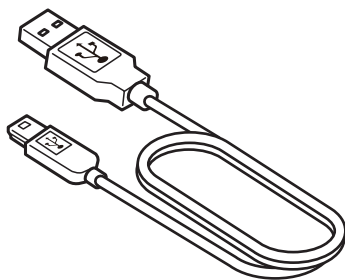

USB cable
(for charging / for operation)

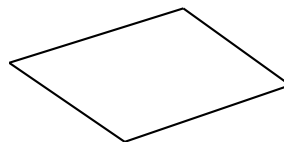

Quick Start Guide &
IMPORTANT SAFEGUARDS

Part names

Tablet: Front view

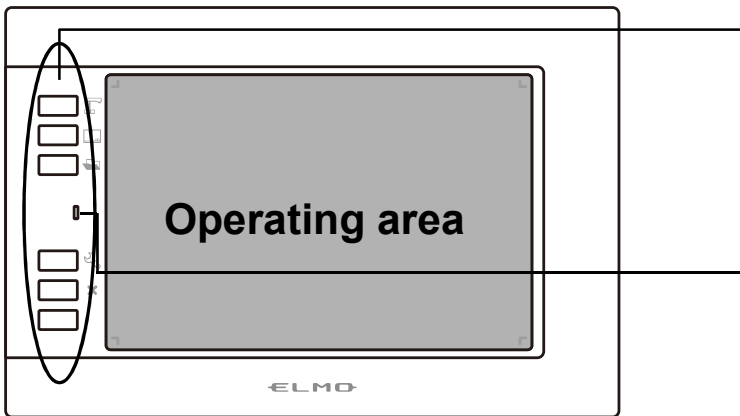

Shortcut keys

To select the tablet operations.
〈Selecting the mode (⇒P.18)〉

Status LED

To indicate the operational status and battery level. 〈About the Status LED (⇒P.20)〉

Rear view

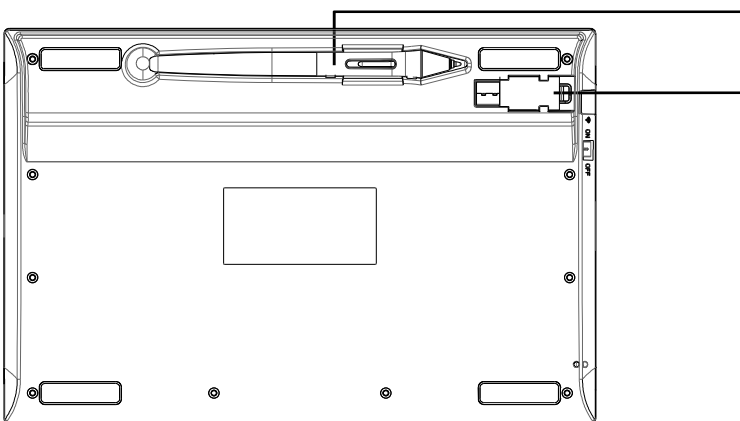

Pen storage

To store the pen.

Wireless dongle storage

To store the wireless dongle.
〈Storing the pen and wireless dongle (⇒P.19)〉

Side view

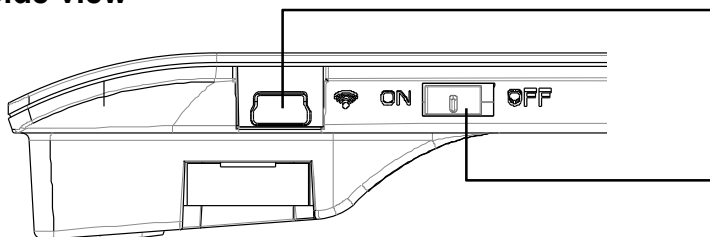

USB port

To connect to a computer to charge the tablet.
〈Charging (⇒P.11)〉

Wireless switch

To switch between “enable wifi” and “disable wifi” when using the wireless dongle with a computer or the document camera.
Set this switch to ON when using wifi.
〈Turning on the tablet (⇒P.16)〉

Pen

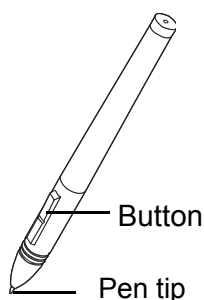

Preparations

Charging

Before use, check whether the tablet is charged.

① Connect a computer and the tablet with the USB cable.

When charging starts, the "Status LED" on the center left of the tablet turns red.

When charging is complete, the "Status LED" turns off.

Charging time: Approx. 4 hours

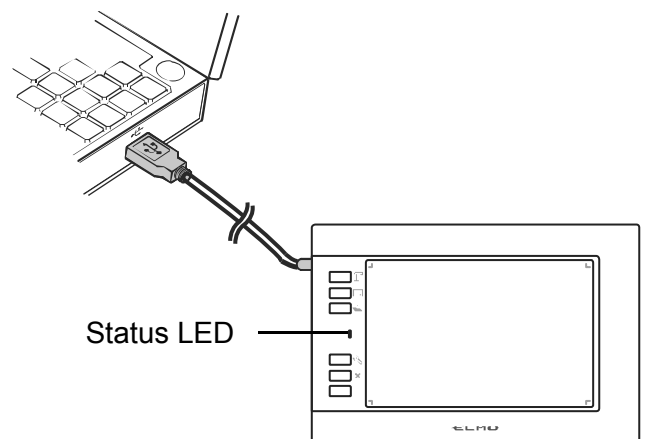

Caution

· Disconnect the USB cable from the tablet when charging is complete.

Installing the touchscreen electronic blackboard software “ELMO Interactive Toolbox (EIT)”

The touchscreen electronic blackboard software “ELMO Interactive Toolbox (EIT)” will be used to perform various operations such as annotation.

※Annotation can be performed by using the Microsoft Paint when the tablet is connected to a computer with the USB cable.

Before using the tablet, EIT needs to be installed in your computer.

※You can use the tablet as a mouse without installing EIT.

Install EIT according to the following instructions:

The installation of EIT needs to be done once when the tablet is used with a computer for the first time. (The installation of EIT is not required each time the tablet is used with a computer.)

• When using Windows:

① Download “EITSetup_0.0.0.zip” from the following ELMO official websites.

<https://www.elmoussa.com/>

<https://www.elmoeurope.com>

② Unzip the downloaded zip file and the msi file will be created.

Start the msi file and follow the instructions to install.

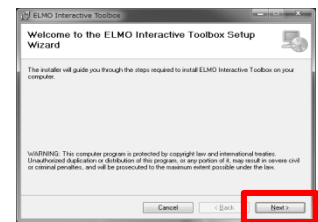

③ When the software is successfully installed, the “ELMO Interactive Toolbox” shortcut icon will appear on the desktop.

• When using Mac:

① Download “ELMO Interactive Toolbox_0.0.0.pkg” from the following ELMO official websites.

<https://www.elmoussa.com/>

<https://www.elmoeurope.com>

② Start the downloaded pkg file and follow the instructions to install.

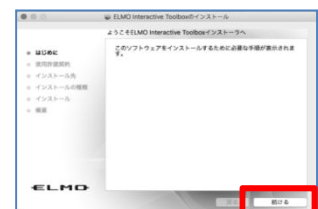

Depending on your computer, you may be asked to restart the computer. In that case, press “YES” to restart the computer.

Basic tablet operations

This section describes the basic tablet operations, and the operation names.

Basic pen operations

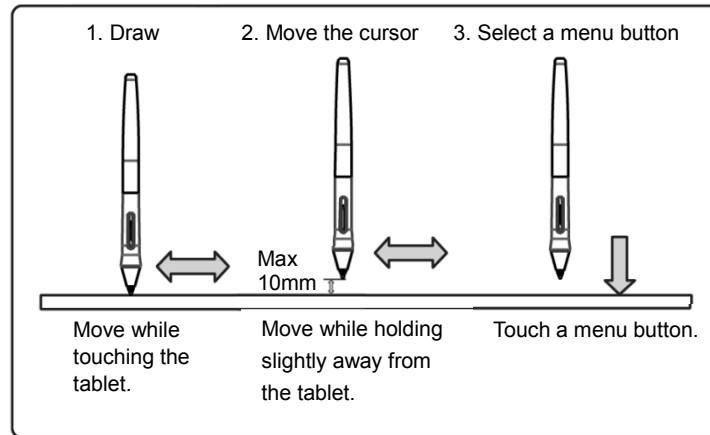

■ Dragging (To annotate)

Move the pen while touching the tablet.

When the pen icon is selected, a line is drawn according to the pen movement.

Use this function to annotate or delete.



■ Cursor movement (To move the cursor)

Move the pen while holding it slightly away from the tablet.

The cursor on the screen moves according to the pen movement.

Use this function to move the cursor.

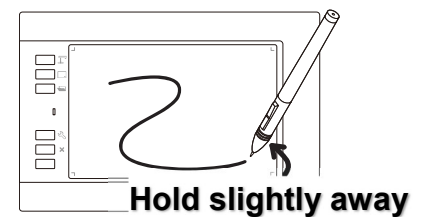

■ Touching (To select a menu button)

Move the cursor while holding the pen slightly away from the tablet, and touch the tablet within the operating area.

Use this function to select menu buttons.

※To use shortcut keys, press the desired button.

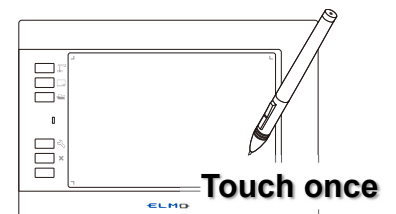

Do not apply excessive strength when touching the tablet with the pen.

 **Note**

- If the pen is used at an acute angle, the pen position may not be recognized correctly. Use the pen at a perpendicular angle as much as possible.
- The tablet's operating area corresponds to the entire screen.

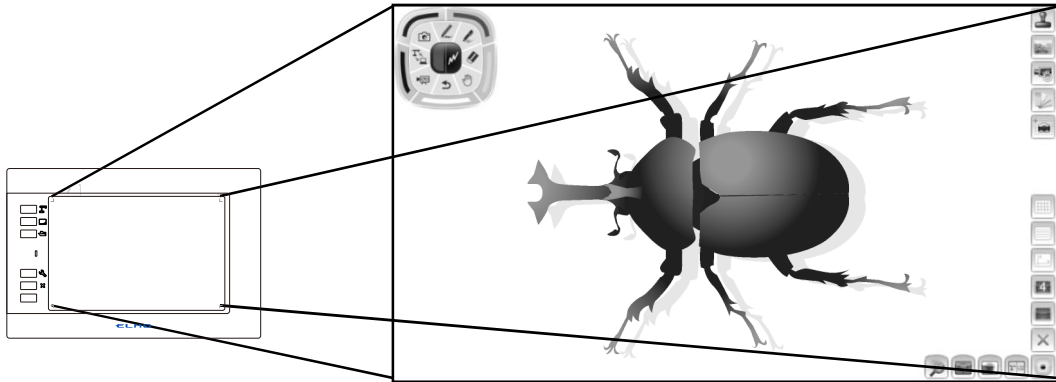

Basic screen layout of EIT

This section describes the basic screen layout of EIT.

For details about EIT, refer to the instruction manual of EIT. (⇒P.12)

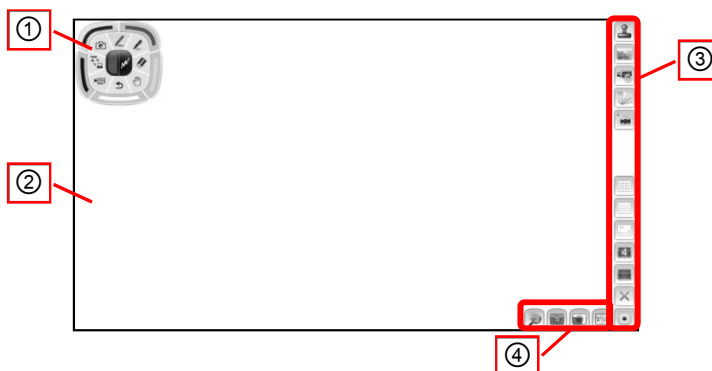

■Display screen

①	Operation panel	The following operations can be performed from the operation panel: - To select the type of pen - To configure the settings such as “Delete All” - To switch to the document camera image - To switch to the drawing screen
②	Drawing area (Entire screen)	This area is for displaying the document camera image and drawing. The entire screen will be the drawing area.
③	Menu area	These buttons are for configuration or operation of the document camera.
④	Sub menu area	These buttons are for advanced operations. The buttons to be displayed varies depending on the mode.

How to Use

This product can be used wired or wirelessly.

1. Setting up the devices (Document camera, Computer, Projector, etc.)

For details of operations on the connected devices, please refer to the instruction manual of respective devices.

■Connecting wirelessly

Using with the document camera

You can operate the tablet without a computer by using the annotation function of the document camera.

Connect the wireless dongle to the USB port of the document camera and turn on the document camera.

※ For information about document cameras which can be used without a computer, refer to “Supported document cameras” in “Product Specifications”. (⇒P.23)

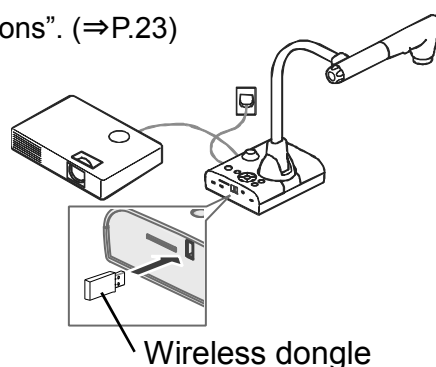

Using with a computer

You can use the tablet as a mouse to control a computer.

You can also perform various operations such as control of the tablet and annotation by using the touchscreen electronic blackboard software “ELMO Interactive Toolbox (EIT)”.
(EIT needs to be installed in your computer beforehand.)

(EIT needs to be installed in your computer beforehand.)

Connect the wireless dongle to the USB port of your computer and turn on the computer.

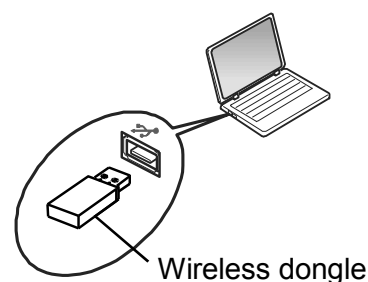

For Windows, the first time you connect the document camera, the driver installation may start. Follow the instructions on the screen to perform the installation.

■ Connecting with the USB cable

Using with the document camera

Connect the tablet and the document camera with the supplied USB cable.

You can draw on the document camera image.

Using with a computer

Connect the tablet and your computer with the supplied USB cable.

You can draw on the computer screen.

2. Turning on the tablet

Set the wireless switch to ON. (⇒P.10)

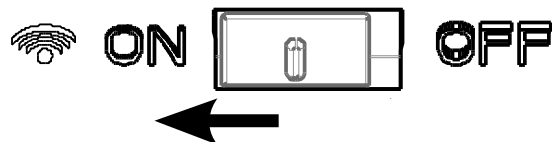

When the power is turned on, the Status LED lights up once in green and then turns off.

※When the battery level is low, the Status LED flashes red.

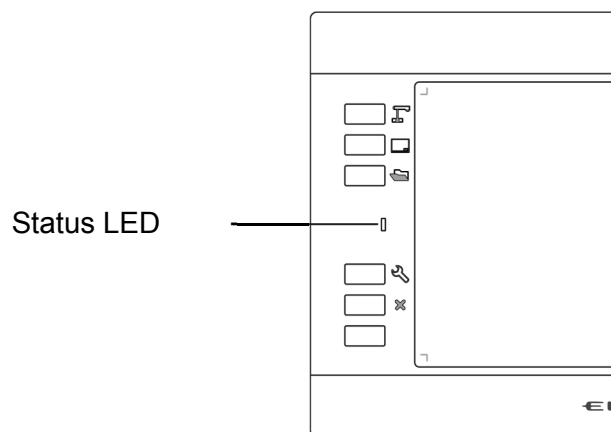

3. Operating the tablet

Pen recognition of the tablet is started when the operating area is touched by the pen tip.

※Only when using wireless connection, if there is no operation for a certain period of time (about 45minutes), the tablet will automatically switch to standby mode.

Using with the document camera

You can operated the icon or draw on the document camera image.

Using with the document camera and computer

You can use the tablet as a mouse of your computer.

The image of the document camera appears when EIT is started. You can draw on the displayed image. (⇒P.12)

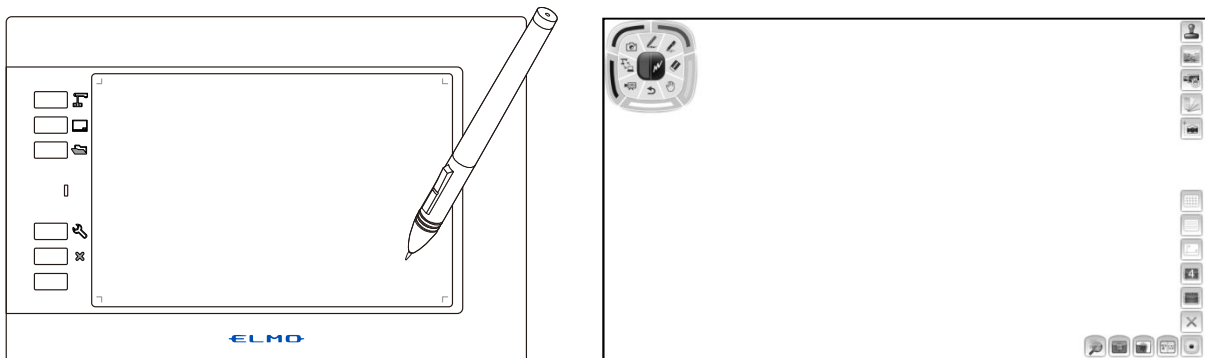

Do not change the display resolution of your computer when EIT is running.

Pen operation

Touching the pen tip to the operating area of the tablet works as left click of a mouse.

Pressing the upper button of the pen in the operating area of the tablet works as right click of a mouse. When using with the document camera, you can erase the drawing by using the upper button and lower button.

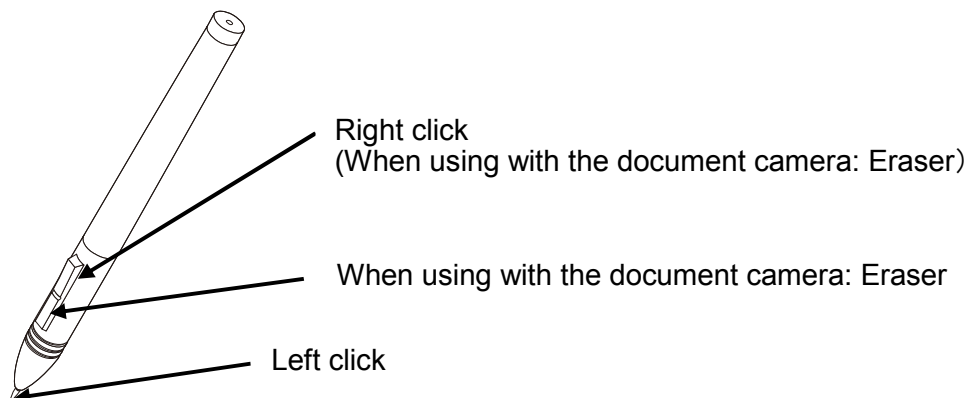



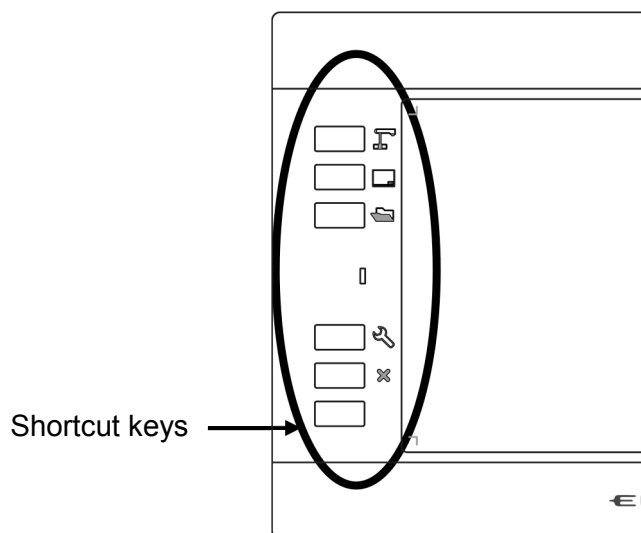

Selecting the mode

By touching the shortcut keys on the left side of the tablet, you can select the mode that you want to use. Details of the modes are described in the table below.

※Available functions may differ depending on the document camera used.



Mode	Shortcut key	Description
Document camera mode		To display the document camera image Use this mode when using the tablet with the document camera.
Whiteboard mode		To display the background image. Use this mode when using the tablet as a whiteboard.
Playback mode		To display the stored images. The selected image will be displayed in this mode.
Operation/ Settings mode		<u>When connecting to a computer:</u> To control a computer as a mouse. <u>When connecting to the document camera:</u> To configure pen settings.
Close/ Hide		<u>When connecting to a computer:</u> To close the EIT. <u>When connecting to the document camera:</u> To display or hide menus.

Other Functions

This section describes various functions related to the tablet.

Replacing the pen tip

When the pen tip becomes round, replace it with the supplied extra core.
Use the supplied pen holder when replacing the pen tip.

 - When replacing the pen tip, be sure to replace it with the supplied "extra core".
Caution - Make sure that children do not put small parts into their mouths.

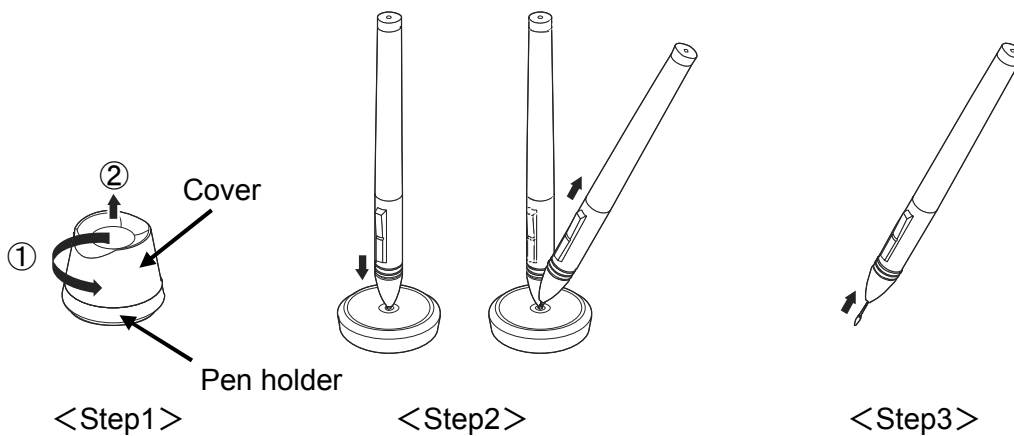

Step1: Rotate the pen holder counterclockwise (arrow①) and remove the cover (arrow②).
Step2: Put the pen to the center of the pen holder. Tilt the pen to remove the pen tip.
Step3: Insert the extra core firmly into the pen until it stops.

Storing the pen and wireless dongle

You can store the pen and wireless dongle in the tablet.
The falling prevention lock is applied.

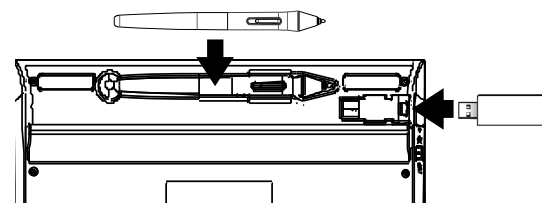

Back of the tablet

 When storing the wireless dongle, make sure it is securely stored in the tablet, and be careful not to drop it while carrying it around.
Caution

About the Status LED

The Status LED on the tablet indicates the status of the device.

■ Status LED

LED status	Operation
Off	When the wireless switch is ON, communication with the wireless dongle is being performed correctly.
Red	Charging. (Turns off when charging is complete)
Flashing Red	- The remaining battery level is 3% (usable time of the tablet is about 10minutes).
Green	During drawing or key operation.
Yellow	During drawing or key operation.(Charging)
Flashing green (Only once)	When the wireless switch is turned on, it flashes only once to indicate that it has started.

Troubleshooting

If trouble occurs or you have any queries, first check this section.

If the problem persists, check your warranty and contact the dealer where you purchased the product.

Cannot turn on the tablet.	
Is the tablet fully charged? (⇒P.11)	Refer to "Charging" and then charge the tablet.
Cannot use the tablet. / The cursor does not move.	
Is the wireless dongle connected to your computer or the document camera? (⇒P.15)	<p>Check that the wireless dongle is connected to the computer or document camera being used.</p> <div style="border: 1px solid black; padding: 5px;">  <p>Caution Connect the wireless dongle directly to the USB port of the computer or the document camera. It may not operate correctly if a USB hub is used.</p> </div>
The tablet is in standby mode. (⇒P.17)	Only when using wireless connection, if there is no operation for a certain period of time (about 45minutes), the tablet will automatically switch to standby mode. In that case, set the wireless switch to ON.(⇒P.16)
The wireless connection is unstable.	<p>If a wireless device or electronic equipment is used near the tablet, the communication between the tablet and wireless dongle may be unstable due to interference from electric waves.</p> <p>Do not use equipment that causes interference near the tablet.</p>
Multiple monitors are used.	<p>The tablet does not support multi-monitor setup.</p> <p>The tablet can be used only with the main monitor even in the multi-monitor setup.</p>

Communication between the tablet and wireless dongle is unstable	
Third-party tablet software is installed.	<p>If third-party tablet software is running, it may conflict with the operations of this tablet.</p> <p>Do not operate third-party tablet software while using this tablet.</p>
Are the tablet and wireless dongle in proper condition?	<p>If there is an obstruction between the tablet and the wireless dongle, the communication may be unstable. The communication may also be unstable, due to the inherent characteristics of wireless communication, depending on the installation angle of each device.</p> <p>Remove the obstruction or change the installation location.</p>
A wireless device or electronic equipment is used nearby.	<p>A wireless device or electronic equipment may interfere with the communication between the tablet and wireless dongle.</p> <p>The communication with the wireless dongle may become unstable if;</p> <ul style="list-style-type: none"> - a wireless device or electronic equipment is being used nearby, or - there is an obstruction between the tablet and wireless dongle, or - the tablet is placed on top of a computer, or - the tablet is moved quickly while being used. <p>If the condition persists, stop using the wireless device or electronic equipment, or move to a location with no interference.</p>

Product Specifications

Product specifications

Model Name	CRA-2
Model Name	0°C ~ 40°C
Operating Temperature	8.0 × 5.0 inches (203.2mm×127.0mm)
Reading Range	0.005mm
Reading Resolution	0.3mm
Reading Accuracy	When wired : 266PPS When wireless : 233PPS
Reading Speed	10mm
Pen Pressure Level	8192 level
Wireless Band Used	2.4GHz
Communication Range	Approx. 15 m (differs depending on the usage conditions)
Power Supply	Lithium-ion battery
Continuous Operation Time	Approx. 15 hours (differs depending on the usage conditions)
Auto Power Off Time	Approx. 45 minutes
Full Charging Time	Approx. 4 hours
Consumption Current	When using USB: 5V 500 mA When using lithium ion battery: 3.7V 67 mA
Computer Models	Computers equipped with a standard USB port (TypeA) (Operation is not guaranteed for all computer environments.)
Compatible OS	Windows 10 / 8.1 / 8 / 7 Mac OS X 10.15 / 10.14 / 10.13 / 10.12 / 10.11
Supported Document Cameras	L-12iD, TT-12iD, L-12F, TT-12F, L-12W, TT-12W, MA-1, MO-2 (Some functions may not be available depending on the model.)
External Dimensions	W310× D207 × H27.2mm
Weight	Approx. 530g (including the tablet, wireless dongle, and pen)

Disclaimer

The contents of this manual and supplied application software may be changed in the future without prior notice.

The software installed on your computer or your peripheral devices may inhibit the operation of ELMO software.

ELMO accepts no responsibility whatsoever for any losses, direct or indirect, that result from the use of ELMO software.

About trademarks

The following trademarks and registered trademarks are used in this manual.

ELMO is a registered trademark of ELMO Co., Ltd.

The full title for Windows® 7 is the Microsoft® Windows® 7 operating system.

The shortened form of the OS name is used in the text.

The full title for Windows® 8 is the Microsoft® Windows® 8 operating system.

The shortened form of the OS name is used in the text.

The full title for Windows® 8.1 is the Microsoft® Windows® 8.1 operating system.

The shortened form of the OS name is used in the text.

The full title for Windows® 10 is the Microsoft® Windows® 10 operating system.

The shortened form of the OS name is used in the text.

Microsoft and Windows are registered trademarks of the Microsoft Corporation in the U.S. and other countries.

Mac, Mac OS and OS X are trademarks of Apple Inc., registered in the United States and other countries.

All other company/product names described in this manual are trademarks or registered trademarks of their respective companies.

株式会社エルモ社

〒457-0078
名古屋市南区塩屋町一丁目3番地4
Web : <https://www.elmo.co.jp>

製品のお問い合わせは、下記営業所へ

- 東日本営業所
 - 札幌オフィス
〒001-0021 札幌市北区北21条西8丁目3番8号
バックビル
TEL. 011-738-5811
 - 仙台オフィス
〒980-0802 仙台市青葉区二日町13番18号
ステーションプラザビル6階
TEL.022-266-3255
- 首都圏営業所
〒108-0073 東京都港区三田3丁目12番16号
山光ビル4階
TEL.03-3453-6471
- 中日本営業所
 - 名古屋オフィス
〒457-0078 名古屋市南区塩屋町一丁目3番地4
TEL.052-811-5261
 - 京都オフィス
〒604-8101 京都市中京区柳馬場御池下る柳八幡町
65 京都朝日ビル10階
TEL.075-744-1360
 - 大阪オフィス
〒550-0002 大阪市西区江戸堀1丁目9番6号
肥後橋ユニオンビル10階
TEL.06-6443-6001
 - 神戸オフィス
〒550-0002 大阪市西区江戸堀1丁目9番6号
肥後橋ユニオンビル10階
TEL.06-6443-6001
- 西日本営業所
 - 福岡オフィス
〒812-0039 福岡市博多区冷泉町2番8号
朝日プラザ祇園2階
TEL.092-281-4131
 - 広島オフィス
〒730-0012 広島県広島市中区上八丁堀4-1
アーバンビューグランドタワー1104号室
TEL.082-221-2801
 - 熊本オフィス
〒861-2104 熊本市東区秋津3丁目11-7
TEL.096-282-8338

OVERSEAS SUBSIDIARY COMPANIES

ELMO USA CORP.

Headquarters
6851 Jericho Turnpike
Suite 145
Syosset, NY 11791
Tel. (516) 501-1400
Fax.(516) 501-0429
E-mail : elmo@elmousa.com
Web : <https://www.elmousa.com/>

ELMO Europe SAS

Headquarters
12 place de la Défense
Maison de la Défense
92974 Paris la Défense Cedex FRANCE
Tel. +33 (0) 1 73 02 67 06
Fax. +33 (0) 1 73 02 67 10
E-mail : info@elmoeurope.com
Web : <https://www.elmoeurope.com/>

German Branch
Monschauerstr. 1
40549 Düsseldorf Germany
Tel. +49 (0) 211 544756 40
Fax. +49 (0) 211 544756 60
E-mail : info@elmo-germany.de
Web : <https://www.elmo-germany.de/>

Middle East Branch
5WA-129, Dubai Airport Free Zone,
P.O Box 371556, Dubai,
United Arab Emirates
Tel. +971-(0)4-260-2390
Fax. +971-(0)4-260-2392
Web : <https://www.elmoeurope.com>

ELMO CO., LTD.

1-3-4, Shioya-cho, Minami-ku
Nagoya, 457-0078, Japan

6X1CRAA04 R0-Zox