

# plus



## Wireless microphone system



# Modern solutions for modern spaces

Intuitive technology for crisp audio capture in  
unsupervised spaces.

Launching summer 2024

[www.catchbox.com](http://www.catchbox.com)

# Create spaces where people feel present

High-quality audio is paramount to ensuring the active participation and engagement in today's work and learning spaces. Catchbox supports exceptional audio and user experience that eliminates communication barriers and allows participants to focus on the discussion's substance.



## Education

For classrooms and lecture halls

- Professor and student voice lift
- Crisp recordings and clean captions
- Exceptional hybrid and assistive audio



## Companies

For team meetings and all-hands spaces

- Presenter and audience audio capture
- Clean meeting transcripts and recordings
- Hybrid conferencing in large rooms



## Events

For conferences and seminars

- Presenter and audience voice lift
- Exceptional hybrid event audio
- Crisp event playback recordings

# Trusted by top organizations



"I believe that any university would benefit from using Catchbox products. Their team is very responsive and they have unique products that you're not going to find anywhere else."

**Scott Pritchett**

Multimedia Manager, University of Central Florida



Scan QR to watch case study

slido

PACE  
UNIVERSITY

airbnb

UF  
UNIVERSITY OF  
FLORIDA

facebook

# Whole-room audio capture solution

Today we rely on professional A/V solutions for essential connectivity. Be it a hybrid meeting or lecture capture, we know it ain't easy to mic up everybody in the room. The Catchbox Plus is a professional wireless microphone system designed to capture crisp audio from both the presenter and the audience no matter the size or acoustical challenges of the room in a user-friendly and cost-effective way.

## Designed for universities and corporations

### Catchbox Control

Remote control and monitoring software for managing Plus systems across the organization.



### Stick

Handheld wireless mic for presentations.



### Cube

Wireless throwable mic for audience audio capture.



### Hub

4 channel wireless microphone receiver with mixing and processing capabilities.

### Clip

Wearable lavalier mic for hands-free presentations.

### Home stations

Dedicated chargers ensure mics are always charged and ready for use.



**Pick and choose mics to include**



**Free priority shipping**



**Made in Europe**

# Professional audio, exceptional user experience

The design of the Catchbox Plus wireless microphone system places user experience and audio quality at the forefront leaving no space for compromises.

## Seamless integration and installation

No matter the complexity of your setup, the Catchbox Plus easily integrates into existing IT/AV infrastructures. The installation of the Plus system doesn't require complex wiring or product configuration. Get your system up and running in a matter of minutes.



## Pick up and talk

Let the professors and team leads focus on what they do best. Introducing the Plus system in your organization doesn't require extensive product training. When ready for use, simply pick up the mics from the home stations and they'll be ready for use without any additional setup steps (e.g. lav wiring turning the mic on).

## Save time on maintenance

The Remote Control & Monitoring Center provides a full overview and control over your fleet of Catchbox Plus systems across your campus or business center. The dedicated charging stations ensure the microphones are ready for use all day, every day.

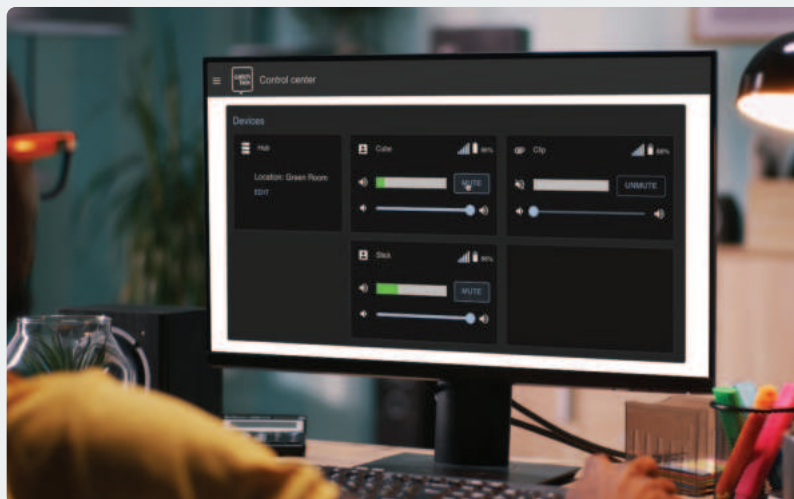

# Hub

## 4 mic channel receiver

The Hub is a 4 channel microphone receiver at the heart of the Plus system. The Hub's versatile design offers flexibility with integration in simple plug & play setups as well as complex A/V infrastructures.

### Integrated DSP

The built-in audio processing ensures organic voice to audio experience for the in-room amplification and videoconferencing.

### Dante™ / PoE

Utilize the built-in Dante™ audio over IP functionality and integrate your systems into your existing Dante™ infrastructure.



### Remote control

Control and monitor your Plus systems via Catchbox Control center, media control systems (Q-SYS, Utelogy) or integrate it in your own control system via the API.



### License-free DECT

Utilizing the robust DECT technology (1.8/1.9 GHz band), the Plus system provides uninterrupted, stable & crisp audio at all times.

### Versatile connectivity

Integrate the Hub receiver with your managed A/V infrastructure (connect it directly to a PA system, or simply connect it to your computer).

### Integrated automixer

Minimize the build-up of background noise and improved gain before feedback with the integrated automixer for multiple microphone inputs.

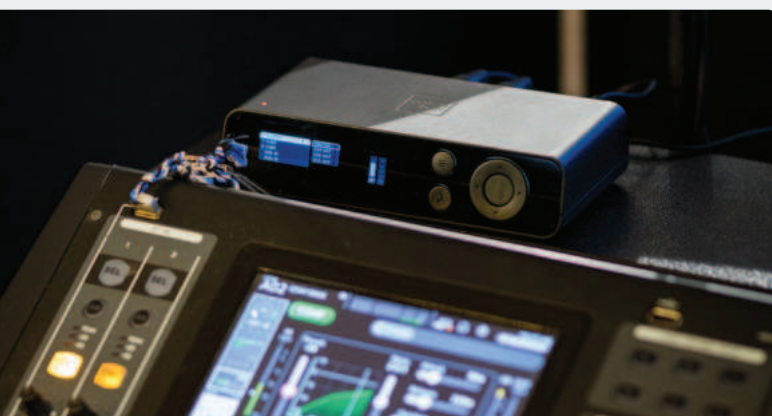

# Cube

## Throwable audience mic

The Cube throwable mic is a combination of innovative product design and state of the art audio technology. The combination of ultra-light materials and technical fabrics create a product that is safe, durable and easy to use for capturing crisp audience audio in large spaces.

### Enhanced engagement & structured discussions

The throwability aspect introduces a dynamic element to any discussion. Facilitate a structured discussion by passing the Cube to the intended person.

### Light & soft

The robust foams and technical fabrics ensure that the Cube won't cause harm to the electronics or the person catching it.

### Customizable cover

Make the Cube your own by adding your brand logos and colors.

### Magnetic lock

The Cube features a unique magnetic locking mechanism that prevents the inner capsule from popping out when the device is thrown.

### Automute™ technology

The Cube automatically mutes when being thrown, caught or dropped.

### Self-disinfecting fabric

Cube's fabric applies ViralOff™ antimicrobial technology, which reduces over 99% of microbes (viruses, bacteria, fungi) on the Cube cover and foam cap.

### Charging base

Dedicated charging base keeps the Cube always charged and ready for use.



# Clip

## Wearable presenter mic

The Clip is a wearable lavalier mic for powerful hands-free presentations delivering exceptional presenter's audio. Clip's innovative, user-centric design eliminates the need for additional setup and microphone wiring before presentations, ensuring an intuitive experience for the end user.

### Customizable jacket

The Clip Jacket can be customized with bespoke logos and colors.

### Quick-mute function

The singular ergonomic button makes it easy to mute and unmute the Clip at a moment's notice.

### Range alarm system

Never worry about leaving your mic on again. The clever built-in alarm system will alert the wearer when the mic is taken out of range.

### Wearable

Effortlessly attaches onto clothes for the ultimate hands-free experience. Alternatively, wear on the easy-on, easy-off magnetic lanyard.

### Charging dock

Dedicated charging dock station keeps the Clip always charged and ready for use.

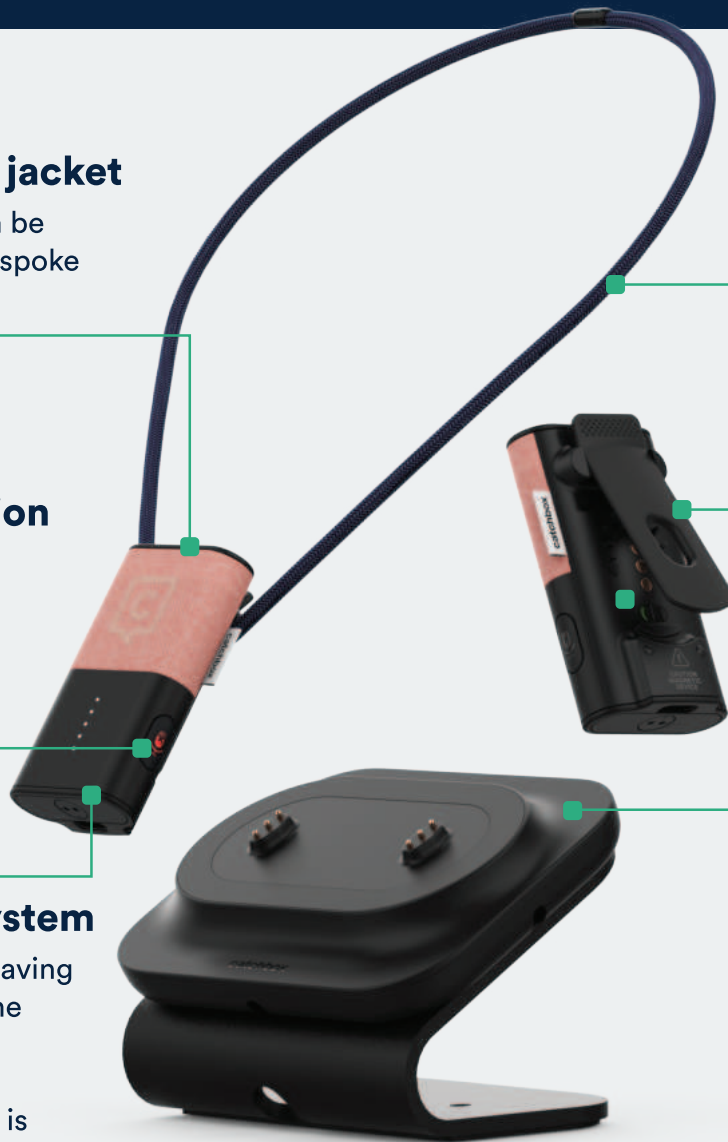

Explore the Catchbox Plus system

# Stick

Handheld presenter mic

The Stick is a handheld wireless mic for powerful presentations, delivering exceptional presenter's audio. The ergonomic design of the Stick makes it not only comfortable to hold but also less intimidating, ensuring presenters can speak with confidence.

## Customizable jacket

Make the Stick your own by adding your brand logos and colors.

## Range alarm system

The clever built-in alarm system will alert the user when the mic is taken out of range.

## Quickmute function

Stick utilizes a singular ergonomic button which makes it easy to mute and unmute at a moment's notice.

## Charging dock

Dedicated charging dock station keeps the Stick always charged and ready for use.





# Make the mics “yours”

Place your brand at the heart of every conversation.  
Go beyond the standard colors and the Catchbox logo and fit the mics into your organization or event.  
Your color, your graphics.



## Interchangeable cover and jacket

Looking for a change? All Cube Covers and Clip/Stick jackets are interchangeable making it possible to update and swap the design of your mics with ease.

# Technical specifications

## Catchbox Plus general specifications

Audio latency	19 ms
Audio encryption	AES256 (available late 2024)
Radio frequency band	DECT / DECT 6.0 (1.8 / 1.9 GHz band) We will ship the product according to your provided shipping address
Radio output power	Up to 63mW, controllable from Hub
Max # of transmitters in one space	Unsynchronised EU: up to 10, US: up to 6 Synchronised EU: up to 20, US: up to 12
Wireless range	100 m / 330 ft (line of sight)*
Operating temperature range	0 °C (32 °F) to 30 °C (86 °F)

\* The actual operating range depends upon the RF output settings, the surroundings, the signal absorption, signal reflection and signal interference

## Hub (2 or 4 channel configuration)

Audio outputs	Mic 1 - 3-pin, balanced, Mic level Mic 2 - 3-pin, balanced, Mic level Mic 3 - 3-pin, balanced, Mic level Mic 4 - 3-pin, balanced, Mic level Automix - RCA, unbalanced, Line level Automix - L&R, 3-pin, balanced, Mic level Automix - USB-C, digital output
Audio inputs	USB-C - digital input Aux-in - 3.5mm - unbalanced, Line level
Dante™ audio networking	Audio in & out (4x4)
Remote control & monitoring	API   Utelogy, Q-sys   Catchbox Control Software
Radio sync	Local 2.5mm
Antenna type	Built-in antennas
Kensington lock	Yes
Stealth mode	Yes
Weight (without Mounting kit)	300 g / 10.58 oz
Dimensions (without Mounting kit)	184 x 92 x 40 mm / 7.2 x 3.6 x 1.6 in

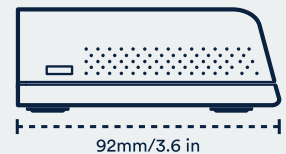
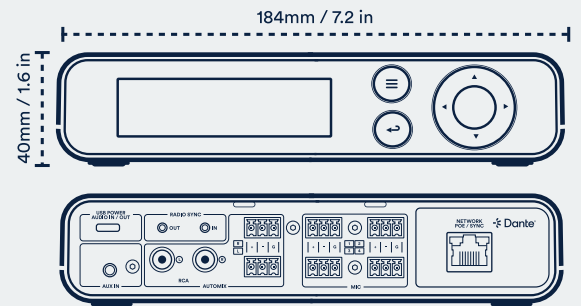

## Mounting Kit

Compatible with	Hub
Mounting options	Dual lock for adhesion mount VESA 100mm pattern for Screw mount
Cable manager	Yes
Weight (without mounting kit)	190 g / 6.70 oz
Dimensions (without mounting kit)	184 x 184 x 44 mm / 7.2 x 7.2 x 1.7 in

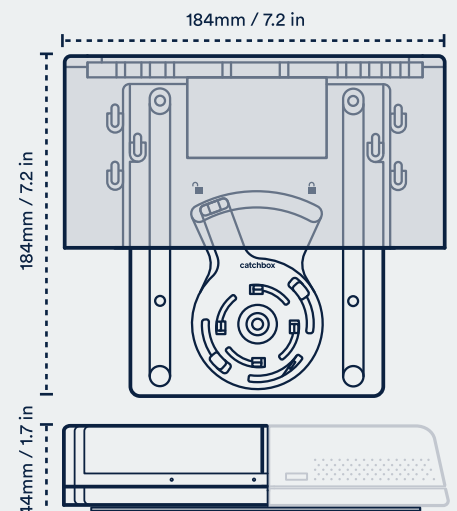

## Cube

<b>Audio frequency response</b>	50 to 20000 Hz
<b>Microphone element</b>	Electret condenser, focused omni-directional
<b>Built-in Automute™ technology</b>	Yes**
<b>Battery type</b>	Li-ion, rechargeable
<b>Battery life</b>	Typical 22h***
<b>Home station - charging base</b>	Yes (included)
<b>Battery charge time</b>	Wireless charger: 6h USB-C: 3h
<b>Weight</b>	370 g / 13.05 oz
<b>Dimensions</b>	180 x 180 x 180 mm / 7 x 7 x 7 in

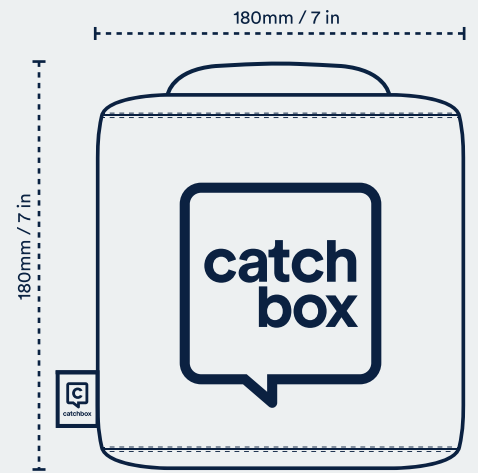

## Clip

<b>Audio frequency response</b>	50 to 20000 Hz
<b>Microphone element</b>	Electret condenser, focused omni-directional
<b>Quick-mute function</b>	Yes
<b>Battery type</b>	Li-ion, rechargeable, replaceable
<b>Battery life</b>	Typical 8h***
<b>Home station - single &amp; dual dock charger</b>	Yes (included)
<b>Battery charge time</b>	Dock charger: 2h USB-C: 2h
<b>Attachment types</b>	Lever (clip on clothing) Lanyard (wear around the neck)
<b>Weight</b>	57 g / 2.01 oz
<b>Dimensions (with lever)</b>	40 x 72 x 28 mm / 1.57 x 2.83 x 1.10 in

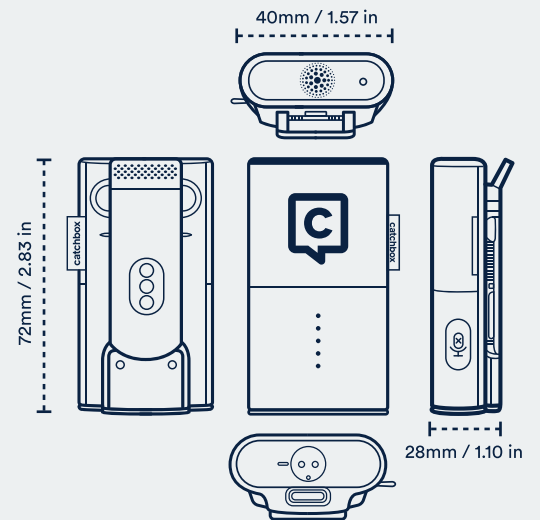

## Stick

<b>Audio frequency response</b>	50 to 20000 Hz
<b>Microphone element</b>	Electret condenser, focused omni-directional
<b>Quick-mute function</b>	Yes
<b>Battery type</b>	Li-ion, rechargeable, replaceable
<b>Battery life</b>	Typical 8h***
<b>Home station - single &amp; dual dock charger</b>	Yes (included)
<b>Battery charge time</b>	Dock charger: 2h USB-C: 2h
<b>Attachment types</b>	No
<b>Weight</b>	232g / 8.18 oz
<b>Dimensions</b>	40,25 x 205 x 28 mm / 1.6 x 8 x 1.1 in

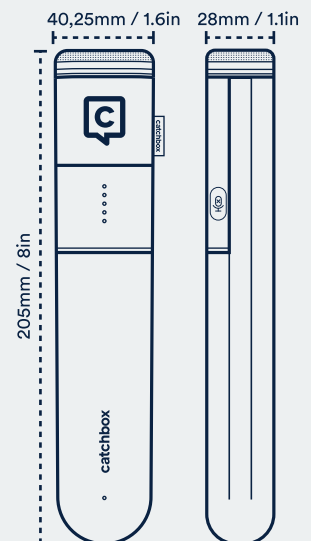

\*\* Automute technology temporarily switches off audio when the microphone is caught, thrown or dropped to eliminate unwanted noise

\*\*\* Depends on selected RF power level

# Our team is here to support you

The journey doesn't end here. Connect with our team to discuss your questions and interest via [sales@catchbox.com](mailto:sales@catchbox.com)



Scan QR to get in touch



# Sign up for launch updates

Stay in the loop and get the latest launch updates on the upcoming launch of the Catchbox Plus system.



Scan QR to sign up