

Hisense

Model PX3-PRO

LC LASER
cinema



Quick Setup Guide

Before using the Laser Cinema, please read this guide carefully and keep it for future reference.

Disclaimer: This Quick Setup Guide is intended as a general guideline to help you set up your Laser Cinema. Images throughout this document are for illustrative purposes only and may differ from the actual product.

© 2024 Hisense Company Ltd. All Rights Reserved.

All material in this Quick Setup Guide is the property of Hisense Company Ltd. and its subsidiaries, and is protected under US, CANADA, MEXICO and International copyright and/or other intellectual property laws. Reproduction or transmission of the materials, in whole or in part, in any manner, electronic, print, or otherwise, without the prior written consent of Hisense Company Ltd. is a violation of Hisense Company Ltd. rights under the aforementioned laws.

No part of this publication may be stored, reproduced, transmitted or distributed, in whole or in part, in any manner, electronic or otherwise, whether or not for a charge or other or no consideration, without the prior written permission of Hisense Company Ltd.

Requests for permission to store, reproduce, transmit or distribute materials may be made to one of the following addresses:

U.S.A. Hisense USA Corporation
105 Satellite BLVD Suite I, Suwanee, GA 30024

MEXICO

IMPORTER:

Hisense Mexico S. de R.L. de C.V.
Blvd. Miguel de Cervantes Saavedra No 301
Torre Norte Piso 2, Col. Ampliación Granada
Miguel Hidalgo, Ciudad de México, C.P. 11520
RFC: HME1105121Y3
TEL: (52) (55) 5531-3515

CANADA Hisense Canada Co., Ltd
2550 Meadowvale Boulevard, Unit 1
Mississauga, ON, Canada
L5N 8C2

Hisense, and any and all other Hisense product names, logo's, slogans or marks are registered trademarks of Hisense Company Ltd. and its subsidiaries. All other trademarks are the property of their respective holders.

Congratulations on the purchase of your new Laser Cinema! This Quick Setup Guide will walk you through a few easy steps to set up your Laser Cinema.

Table of Contents

Register Your Laser Cinema!	2
Important Safety Information	3
Packaged Contents	5
Laser Cinema Diagram	6
STEP 1. Mount the Screen	7
STEP 2. Set up the Laser Cinema	7
STEP 3. Adjust the Display Image and the Screen	11
STEP 4. Use Your Remote	12
STEP 5. Proceed through the Screen Setup Menu	13
Begin to Enjoy Your Laser Cinema	15
Maintenance & Quick Problem-Solving Tips	16
Product Specifications	19
Certification and Compliance	20

For detailed instructions, please refer to the E-Manual.

Register Your Laser Cinema!

Because we value your business, we want to keep you in the know of 'all things Hisense'. Using your mobile phone, scan the Registration page QR code to register your Laser Cinema. Depending on the make and model of your phone, you may need to download a QR code scanning app.

U.S.



<http://www.hisense-usa.com/support/register>

Mexico



<https://hisense.com.mx/support/register>

Canada



<http://www.hisense-canada.com/support/productReg.asp>

Important Safety Information



SAFETY WARNINGS

Do not look directly at the lens when this device is on!

- This product comes with a laser module. Do not tear or modify this device in any manner; otherwise, it may result in personal injury.

RG2

As with any bright light source, DO NOT STARE INTO THE BEAM

IEC 62471-5: 2015

$\lambda = 459\text{-}471\text{nm}/519\text{-}531\text{nm}/635\text{-}651\text{nm}$

Wavelength 459-471nm/519-531nm/635-651nm

CLASS 1 LASER PRODUCT

IEC 60825-1: 2014

Caution—use of controls or adjustments or performance of procedures other than those specified herein may result in hazardous radiation exposure.

The Device Complies with 21 CFR 1040.10 and 1040.11 except for conformance as a Risk Group[0,1 or 2-Select appropriate RG]LIP as defined in IEC 62471-5: Ed.1.0. For more information see Laser Notice No.57, dated May 8, 2019.

- If this device requires a repair, please wear laser eye protection with an optical density OD that is 4 or higher and has a wave length of 459-651 nm.
- Do not place any water-containing vessel on this device, such as cosmetics or liquid medicine.
- If any object or water enters this device, please unplug this device and contact the service staff of Hisense.
- Do not place any exposed fire source (e.g. burning candle) on this device. Keep away from high temperature and heat.
- Do not expose the battery to direct sunlight or candle light.
- Keep air vents on both sides clear from any objects to prevent the device from overheating inside.
- To avoid a short circuit, product damage or electric shock, do not use any sharp object or metal to touch the ports or other openings on the Laser Cinema.
- If this device has been in a warm environment, allow any built-up condensation to evaporate first BEFORE you switch the device

on.

- Do not allow a child to stand on or climb up this device.
- Do NOT place any object above or in front of the lens because the laser light could cause the object to become flammable.
- Clean the lens periodically with a clean cloth and make sure the Laser Cinema is turned off before you start.

Low Blue light Content

- The long-term exposure to blue light may damage your eyes, in particular the retina, causing visual fatigue or eye strain. Children are particularly vulnerable to excessive blue light and the damage to them is irreversible. The product can decrease blue light ratio to reduce blue light hazard.

Health recommendations

- Avoid long time continuous use product, ensure adequate break time.
- Looking at distant objects or exercises for the eye after use product.

Packaged Contents

- Laser Cinema
- 1 Remote control
- 2 AAA batteries
- 2 pairs of gloves for handling the Laser Cinema
- 1 Power Cord
- 1 Wrench to adjust the bottom of the Laser Cinema
- Hisense 4K Laser Cinema Quick Setup Guide
- Important Safety Information & Warranty Card
- Cleaning kit for the lens
- 2 C-shaped blocks
- C-shaped Block Installing Instruction

NOTE:

- The accessories may be different from the list above due to different models, countries/regions. Please refer to the actual accessory bag.
- Screen is not included.

Laser Cinema Diagram

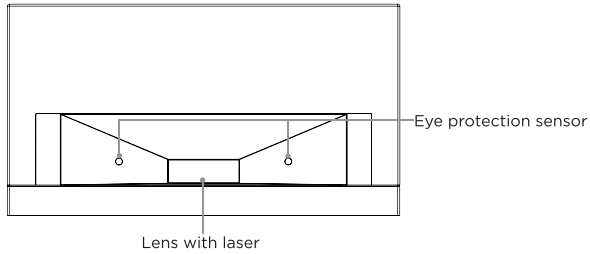
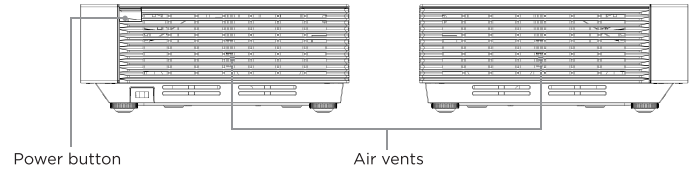
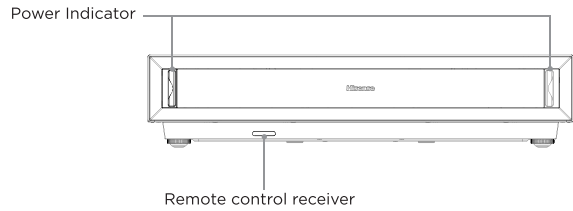

Be sure to protect the lens when you handle this device.

STEP 1 Mount the Screen

If you purchased a screen from Hisense with your Laser Cinema, then refer to the Screen Installation Guide that's included in the package.

STEP 2 Set up the Laser Cinema

Be sure to protect the lens when you handle this device.

1. Now, to get started, we recommend that you connect all cables to the ports on the back of the Laser Cinema before you position it. (Audio, video, Ethernet cables and external devices are not included.)
2. Position the Laser Cinema so it is parallel with the screen surface.
3. Plug the power cord into a wall outlet.
4. Press the POWER button to turn on the Laser Cinema.

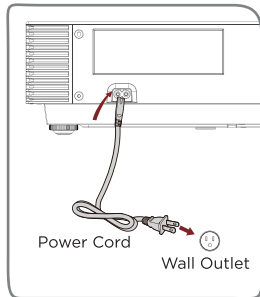

WARNING: Insufficient ventilation space will cause this device to overheat or become damaged.

- Do not block the air vents or place any object on this device.
- Do not place this device in any narrow, enclosed or poorly ventilated space.

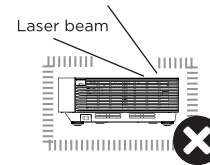

At a minimum, leave the amount of space shown in the diagram below for this device to have proper ventilation.

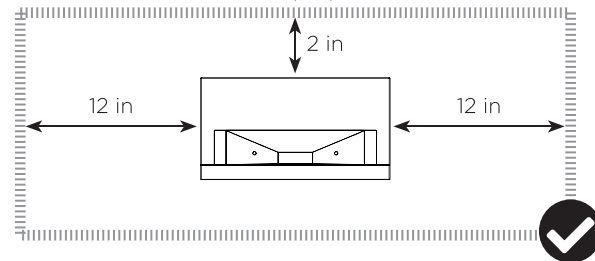

Ports to connect certain cables to

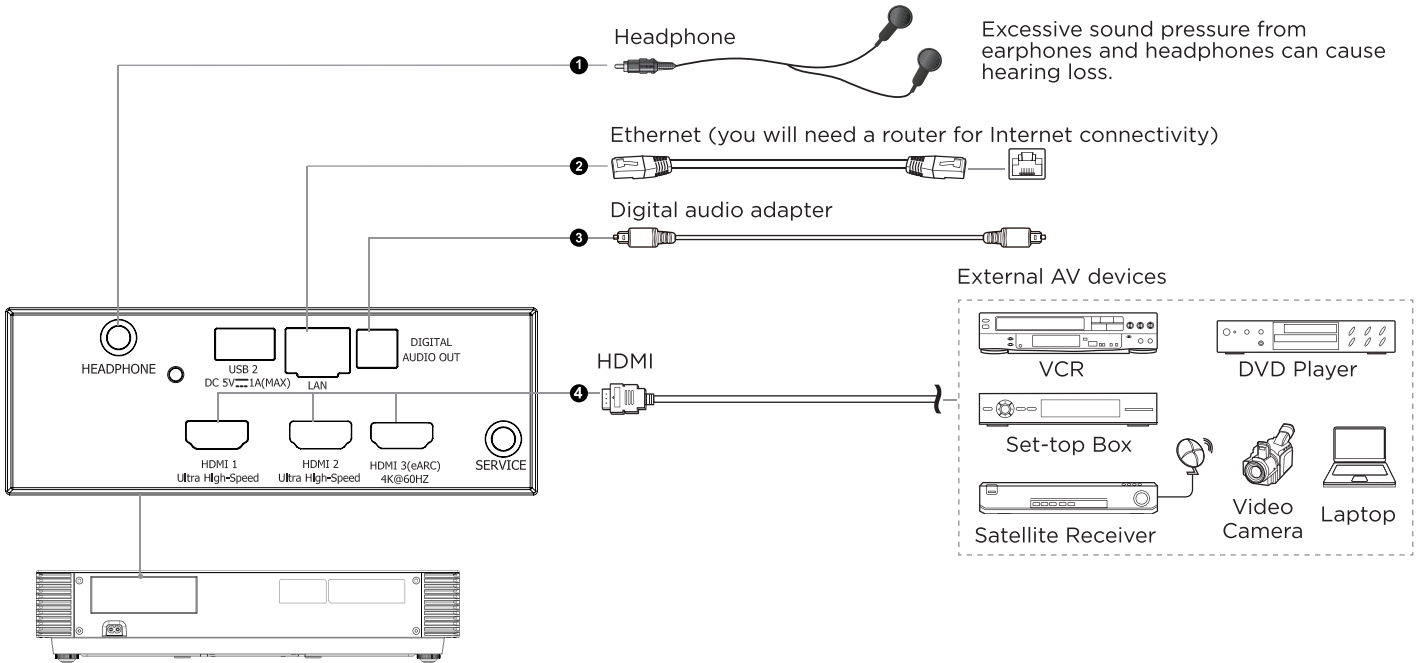

Excessive sound pressure from earphones and headphones can cause hearing loss.

Headphone

Ethernet (you will need a router for Internet connectivity)

Digital audio adapter

HDMI

External AV devices

VCR

DVD Player

Set-top Box

Satellite Receiver

Video Camera

Laptop

Check to ensure that you have selected the right cables for the ports and that they are connected securely. Loose connections can affect the quality of the picture image and color.

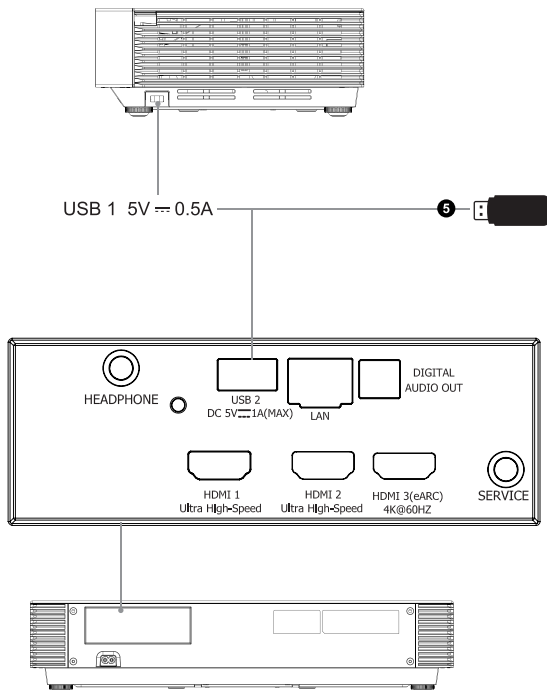

USB devices for browsing photos, music and movies.

NOTE:

- When connecting a hard disk or a USB hub, always connect the mains adapter of the connected device to the power supply. Exceeding a total current consumption may result in damage. The USB2.0 device maximum current consumption is 500mA. The USB3.0 device maximum current consumption is 1A.
- If the impulse current for an individual non-standard high-capacity mobile hard disk is greater than or equal to 1A, it may cause the Laser Cinema to reboot or lock.
- The USB port supports a voltage of 5V.

Image size and projection distance

NOTE: The sizes of the projected image for each projection distance may differ depending on the actual installation environment.

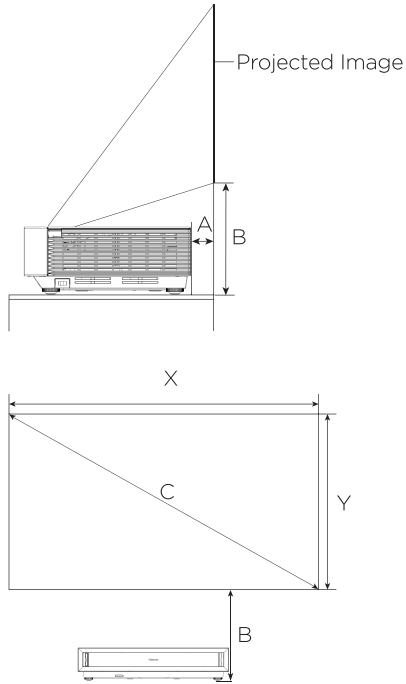

C		X		Y		A		B	
(mm)	(inch)	(mm)	(inch)	(mm)	(inch)	(mm)	(inch)	(mm)	(inch)
2032	80	1771	69.7	996	39.2	119	4.7	326	12.8
2286	90	1993	78.4	1121	44.1	167	6.6	358	14.1
2540	100	2214	87.2	1245	49.0	216	8.5	389	15.3
2794	110	2435	95.9	1370	53.9	265	10.4	420	16.6
3048	120	2657	104.6	1494	58.8	314	12.3	452	17.8
3302	130	2878	113.3	1619	63.7	362	14.3	483	19.0
3556	140	3100	122.0	1743	68.6	411	16.2	515	20.3
3810	150	3321	130.7	1868	73.5	460	18.1	546	21.5

STEP 3 Adjust the Display Image and the Screen

Follow the steps in the order shown below, only if they apply to your situation.

NOTE: Before adjusting, adjust the height of the screen (if you have one) so that screen is vertically level. Rotate feet from an overlooking view, and do not look directly at the lens when this device is on because the laser light may damage your eyes.

Step 1. Make the laser console parallel to the screen. Make sure the bottom of the projected image is parallel to the bottom of the screen.

Step 2. Check the type of projected image you get and do the adjustment as the following instructions. The main goal of the adjustment is to make the image become a rectangle.

The top of the projected image is wider than the screen.



Lift up two front feet of the console.

The bottom of the projected image is wider than the screen.



Lift up two back feet of the console.

The top of the projected image is higher on the right than the screen.

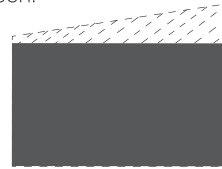

Lift up right front and back feet and then rotate the console counterclockwise.

The top of the projected image is higher on the left than the screen.

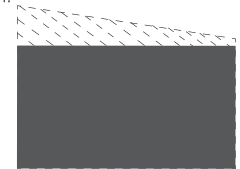

Lift up left front and back feet and then rotate the console clockwise.

Step 3. Move the console farther from the screen to make the projected image larger. Make sure the top, left, right side of projected image cover the border of screen.

Step 4. Check if the bottom of projected image covers the border of screen.

If yes, then continue correction steps.

If no, adjust the height of the screen by using the adjustment rods to make the bottom of projected image covers the border of screen and then continue correction steps.

STEP 4 Use Your Remote

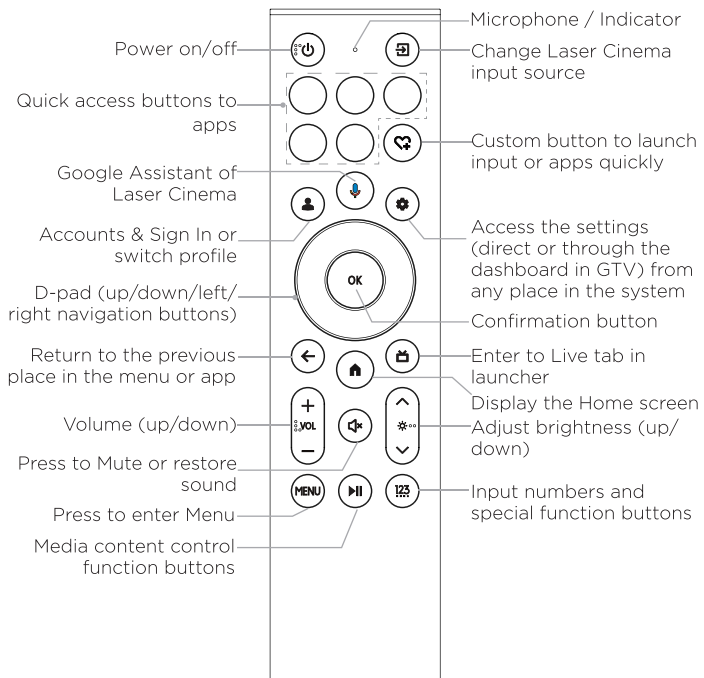

NOTE: The button descriptions are only provided as a reference. The actual appearance of your remote may differ from the buttons that are listed.

1. Press and slide the back cover to open the battery compartment of the remote control.
2. Insert two AAA size batteries. Make sure to match the (+) and (-) ends of the batteries with the (+) and (-) ends indicated in the battery compartment.
3. Restore the battery compartment.

IMPORTANT INFORMATION ABOUT THE REMOTE AND BATTERIES

- Discard batteries in a designated disposal area. Do not throw them into a fire.
- Remove old batteries immediately to prevent them from leaking into the battery compartment.
- If you do not intend to use the remote control for a long time, then remove the batteries.
- Battery chemicals can cause a rash. If the batteries leak, clean the battery compartment with a cloth. If chemicals touch your skin then wash it immediately.
- Do not mix old and new batteries.
- Do not mix alkaline, standard (carbon-zinc) or rechargeable (NiCd, NiMH, etc.) batteries.
- Do not continue using the remote if it gets warm or hot.
- Call our Support Center immediately on the support website.

REMOTE CONTROL RANGE INFORMATION

- The remote control can work at a distance of up to 26 feet in front of the Laser Cinema.

- It can work at a 30 degree horizontal or 15 degree vertical angle.(This angle is used by infrared means in an unpaired state.)

PAIRING THE REMOTE CONTROL

1. Pair the remote to the Laser Cinema after you power it on. Keep the remote control within 10 feet from the Laser Cinema. Press and hold the [←] button and the [🏠] button at the same time or [MENU] button at least 3 seconds to start pairing.
2. If the remote paired successfully then a confirmation will display on the screen. If it did not pair successfully then an unsuccessful message will display. Repeat step 1.

NOTE:

- If an unknown error occurred with the remote then it could have been caused by interference. Try to remove what's causing the interference and pair it again.
- If an unknown error occurred in the remote control while the battery power is normal, you can take out the batteries and press any key for 1-2 seconds, then the remote control can work normally.
- The remote cannot be paired to the Laser Cinema while the Laser Cinema is in standby mode.

STEP 5 Proceed through the Screen Setup Menu

PROJECTION MODE

If you need to flip the image over top-to-bottom and/or left-to-right, select the Projection Mode and press the UP/DOWN buttons.

AUTO KEYSTONE CORRECTION

There are 2 ways to enter auto keystone correction:

- Through the first-time use guide.
- **Menu > Laser Settings > Auto Keystone Correction**

- Step 1.** Before you use Auto Keystone Correction function, ensure that the laser console and your mobile device are connected to the same Wi-Fi network.
- Step 2.** Adjust the position of the laser console and the height of the screen to ensure the frame of screen is located inside the projected image. Click **Next** to continue.
- Step 3.** Scan the QR code with your mobile device and enter the PIN code that shows on the screen, after a few moments a grid pattern will appear on the screen.

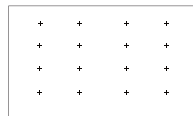

Alignment grid

Step 4. Take a photo of the full screen with your mobile device, then upload it following the instructions on your mobile device.

NOTE:

- The frame of the screen should be fully located inside the projected rectangular border.
- Take the photo in front of the screen.
- Make sure the screen in the photo takes up at least 2/3 of the photo.
- Ensure the 16 points in the grid pattern are fully visible in the photo you take.

MANUAL KEYSTONE CORRECTION

There are 2 ways to enter manual keystone correction:

- Through the first-time use guide.
- **Menu > Laser Settings > Manual Keystone Correction**

Step 1. Adjust the position of the laser console and the height of the screen to ensure the frame of screen is located inside the projected image. Click **Next** to continue.

Step 2. Move the four points of projected image to align the screen by using your remote control.

Press [⊙/⊙/⊙/⊙] button to change control points.

Press [OK] button to confirm the selected point.

After finishing the adjustment, press [←] button to save your setting.

If you are not satisfied with the adjustment you made, click **Reset** to back to the initial status.

NOTE:

- In some special cases, there may be a bulge or depression in the middle of the image and 4-point correction can not complete the adjustment, long press [OK] button to switch to 8-point correction mode.

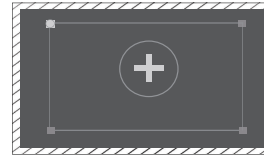

4-point correction

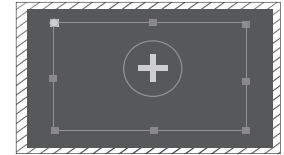

8-point correction

NOTE:

- To return the picture position to the default, select the **Reset** button on the screen.

STEP 6 FOCUS ADJUSTMENT

Press [MENU] button on your remote to select **Menu > Laser Settings > Focus Adjustment**.

You can adjust the focus parameters by pressing the up and down buttons on the remote. The focus effect is adjusted in real time according to the displayed background image card.

EYE PROTECTION

In order to protect your eyes, do not look into the lens. This projector is shutting down in 5 seconds, the Laser Cinema screen is closed immediately (this function will be unavailable temporarily during keystone correction).

Begin to Enjoy Your Laser Cinema

Your Smart Laser Cinema is easy to use and brag-worthy!

After you've completed setting up the language, time and network connection, the Home screen will be your starting point for navigating the Laser Cinema. Gone are the days where your Laser Cinema only provides one way for you to be entertained. Using your remote, press the Home button to begin enjoying your Laser Cinema.

Disclaimer: Subscriptions or other payments may be required to access content through some applications. Some or all of the included or downloaded application services in this Hisense device may not function depending on the Internet connection, local limitations of included applications or other reasons outside of Hisense's control. HISENSE EXPRESSLY DISCLAIMS RESPONSIBILITY FOR ANY APPLICATION SERVICE FROM FUNCTIONING AT ANY TIME, FOR CONTENT IN ANY APPLICATION SERVICE, FOR DISRUPTIONS OF SERVICE, LOCAL OR REGIONAL LIMITATIONS, WARRANTIES OF TITLE, NO INFRINGEMENT, AND FOR IMPLIED WARRANTIES OF MERCHANTABILITY OR FITNESS FOR A PARTICULAR PURPOSE. By purchasing this device, you accept such Disclaimer without any claim on Hisense at any time.

Maintenance

- Do not touch this device when it is running or just turned off because it may be hot.
- Do not wipe this device with oil because it may deteriorate the exterior or damage the paint. Contact with rubber or ethylene products for a long time may cause stains on this device.
- If the outside of the Laser Cinema is dirty, turn off the Laser Cinema and wipe with a dampened soft cloth.
- Do not touch the lens with your hands.
- Do not touch or wipe the lens with ordinary cleaning cloth. Use a dust blower to remove the dust on the lens. Grease, dirt and fingerprints should be cleaned carefully by the professional by using optical cleaning cloth, lens wiping paper or professional cleaning solutions to avoid destroying the optical filming and affecting the image quality.
- To turn off this device, press the Power button on the remote control. Do not cut off the power directly when the device is working.

Quick Problem-Solving Tips

When you experience an issue with your Laser Cinema, turn it off and on again. If this does not resolve the problem, then refer to the tips below.

When I turn on my Laser Cinema, there is a delay for a few seconds before the picture appears. Is this normal?

Yes, this is normal. The Laser Cinema is initializing and searching for previous setting information.

No sound or picture

1. Check if the power cord is plugged into a powered AC outlet.
2. Press the  Power button on the remote control to activate the unit from 'Standby' mode.

3. Check to see if the LED light is on or not. If it is, then the Laser Cinema is receiving power.

I have connected an external device to my Laser Cinema and I get no picture and/or sound.

1. Check for the correct output connection on the external device and for the correct input connection on the Laser Cinema.
2. Make sure you have made the correct selection for the input for the incoming signal.

The picture is normal but there is no sound

1. Check the volume settings.
2. Check if 'Mute' mode is set to On.

Sound but no picture or black and white picture

1. If the picture is black and white, unplug the Laser Cinema from the AC outlet and replug it after 60 seconds.
2. Check that the Color is set to 50 or higher.

The sound and/or picture is distorted or appears wavy

1. An electric appliance may be affecting the Laser Cinema. Turn off any appliances that are nearby and move it farther away from the Laser Cinema.
2. Insert the power plug of the Laser Cinema set into another power outlet.

The plastic cabinet makes a "clicking" type of sound

The 'click' sound can occur when the temperature of the Laser Cinema changes. This change causes the Laser Cinema cabinet to expand or contract, which makes the sound. This is normal and the Laser Cinema is OK.

The remote control does not work

1. Confirm that Laser Cinema still has power and is operational.
2. Change the batteries in the remote control.
3. Check if the batteries are correctly installed.

NEED MORE HELP?

Additional help is available online at support links. You will find answers to frequently asked questions, downloadable firmware and more. If the problem is still not resolved, then contact us at one of the phone numbers below.

U.S.A.

<http://www.hisense-usa.com/support/>

Phone: 1-888-935-8880

Monday - Friday 9 AM to 9 PM EST

Saturday - Sunday 9 AM to 6 PM EST

Email: Service@hisense-usa.com

MEXICO

<http://www.hisense.com.mx/support/>

Phone: 800-008-8880

Monday - Friday: 9:00-21:00 hrs

Saturday: 9:00-15:00 hrs

Email: servicio@hisense.com.mx

CANADA

<http://www.hisense-canada.com/support/>

Phone: 1-855-344-7367

Monday - Friday 8 AM to 8 PM EST

Saturday - Sunday 9 AM to 6 PM EST

Federal holidays excluded

Email: canadasupport@hisense.com

THIS PRODUCT IS LICENSED UNDER THE AVC PATENT PORTFOLIO LICENSE FOR THE PERSONAL USE OF A CONSUMER OR OTHER USES IN WHICH IT DOES NOT RECEIVE REMUNERATION TO (i) ENCODE VIDEO IN COMPLIANCE WITH THE AVC STANDARD ("AVC VIDEO") AND/OR (ii) DECODE AVC VIDEO THAT WAS ENCODED BY A CONSUMER ENGAGED IN A PERSONAL ACTIVITY AND/OR WAS OBTAINED FROM A VIDEO PROVIDER LICENSED TO PROVIDE AVC VIDEO. NO LICENSE IS GRANTED OR SHALL BE IMPLIED FOR ANY OTHER USE. ADDITIONAL INFORMATION MAY BE OBTAINED FROM MPEG LA, L.L.C. SEE [HTTP://WWW.MPEGLA.COM](http://WWW.MPEGLA.COM)

Product Specifications

MODEL NAME	PX3-PRO
DIMENSION (L x D x H)	21.7 x 11.7 x 4.8 inches (550 x 296 x 120 mm)
WEIGHT	19.8 lbs (9.0 kg)
ACTIVE SCREEN SIZE (DIAGONAL)	80 - 150 inches
SCREEN RESOLUTION	3840 x 2160
AUDIO POWER	2 x 15 W + 2 x 10 W
POWER CONSUMPTION	250W
POWER SUPPLY	120-240 V - 50-60 Hz
CONNECTIVITY	Built-in Wireless feature (2x2, three band)
ENVIRONMENTAL CONDITIONS	Temperature: 41°F to 95°F (5°C to 35°C) Humidity: 20% to 80% RH Atmospheric pressure: 86 kPa to 106 kPa
STORAGE TEMPERATURE	5°F to 113°F (-15°C to 45°C)
STORAGE HUMIDITY	10% to 70%, non-condensing

Disclaimer: All products, product specifications, and data are subject to change without notice to improve reliability, function, design or otherwise.

Certification and Compliance

FCC Notice

This device has been tested and found to comply with the limits for a Class B digital device pursuant to Part 15 of the FCC Rules. These limits are designed to provide reasonable protection against harmful interference in a residential installation. This device generates, uses, and can radiate radio frequency energy and, if not installed and used in accordance with the instructions, may cause harmful interference to radio communications. However, there is no guarantee that interference will not occur in a particular installation. If this device does cause harmful interference to radio or Laser Cinema reception, which can be determined by turning the device off and on, the user is encouraged to try to correct the interference by one or more of the following measures:

- Increase the separation between the device and receiver.
- Connect the device into an outlet on a circuit different from that to which the receiver is connected.
- Consult the dealer or an experienced radio/Laser Cinema technician for help.

NOTE: THE MANUFACTURER IS NOT RESPONSIBLE FOR ANY RADIO OR LASER CINEMA INTERFERENCE CAUSED BY UNAUTHORIZED MODIFICATIONS TO THIS EQUIPMENT. SUCH MODIFICATIONS COULD VOID THE USER'S AUTHORITY TO OPERATE THE EQUIPMENT.

The Wi-Fi Module complies with FCC radiation exposure limits set forth for an uncontrolled environment. This device should be installed and operated with a minimum distance of 20 centimeters between the radiator and your body.

Declaration of Conformity

Trade Name: Hisense

Model: PX3-PRO

Responsible Party: Hisense USA Corporation

Address: 105 Satellite BLVD Suite I, Suwanee, GA 30024

Telephone Number: 1-888-935-8880

This device complies with Part 15 of the FCC Rules. Operation is subject to the following two conditions: (1) this device may not cause harmful interference, and (2) this device must accept any interference received, including interference that may cause undesired operation.

Conform to requirements applicable to the Operation Manual as specified in Subclause 6.6.3 of IEC 62471-5:Ed.1 with the following additions:

- a. Notice is given to supervise children and to never allow them to stare into the projector beam at any distance from the projector.
- b. Notice is given to use caution when using the remote control for starting the projector while in front of the projection lens.
- c. Notice is given to the user to avoid the use of optical aids such as binoculars or telescopes inside the beam.



Dolby, Dolby Vision, Dolby Atmos, and the double-D symbol are registered trademarks of Dolby Laboratories Licensing Corporation. Manufactured under license from Dolby Laboratories. Confidential unpublished works. Copyright © 2012-2024 Dolby Laboratories. All rights reserved.



The terms HDMI, HDMI High-Definition Multimedia Interface, HDMI Trade dress and the HDMI Logos are trademarks or registered trademarks of HDMI Licensing Administrator, Inc.



FOR DTS PATENTS, SEE <http://xperi.com/dts-patents/>. MANUFACTURED UNDER LICENSE FROM DTS, INC. AND ITS AFFILIATES. DTS, THE SYMBOL, DTS AND THE SYMBOL TOGETHER, DTS:X, DTS-HD, DTS-HD MASTER AUDIO, NEURAL:X, AND VIRTUAL:X, ARE REGISTERED TRADEMARKS OR TRADEMARKS OF DTS, INC. IN THE UNITED STATES AND/OR OTHER COUNTRIES. © DTS, INC. AND ITS AFFILIATES. ALL RIGHTS RESERVED.



Manufactured under license from IMAX Corporation. IMAX® is a registered trademark of IMAX Corporation in the United States and/or other countries. For DTS patents, see <http://patents.dts.com>. Manufactured under license from DTS Licensing Limited. DTS and the DTS logo are registered trademarks or trademarks of DTS, Inc. in the United States and other countries. © 2020 DTS, Inc. ALL RIGHTS RESERVED.



©2024. All rights reserved. Hisense and the Hisense logo are registered trademarks of Hisense. Other brand and product names are registered trademarks of their respective owners.

Back View

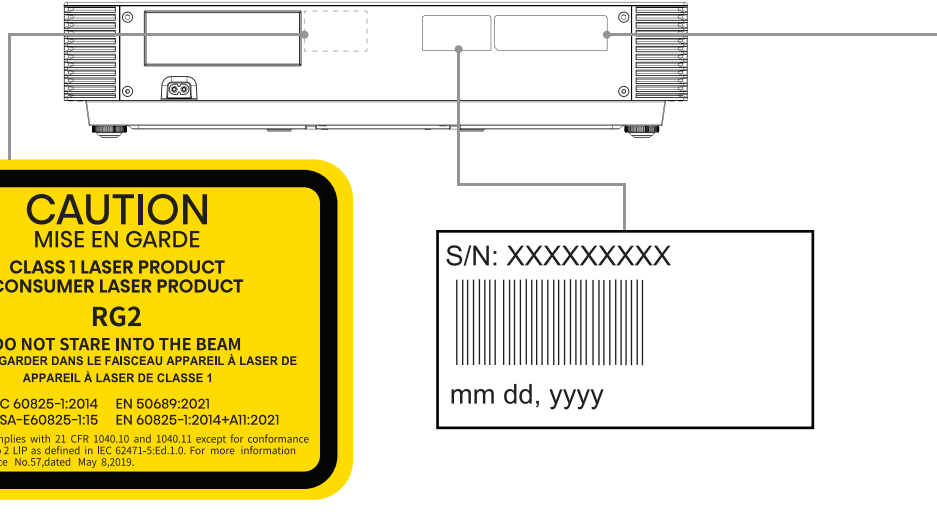

CAUTION
MISE EN GARDE
CLASS 1 LASER PRODUCT
CONSUMER LASER PRODUCT
RG2

DO NOT STARE INTO THE BEAM
NE PAS REGARDER DANS LE FAISCEAU APPAREIL À LASER DE
APPAREIL À LASER DE CLASSE 1

IEC 60825-1:2014 EN 50689:2021
CAN/CSA-E60825-1:15 EN 60825-1:2014+A11:2021

The Device Complies with 21 CFR 1040.10 and 1040.11 except for conformance as a Risk Group 2 (RP) as defined in IEC 62471-5:Ed.1.0. For more information see Laser Notice No.57,dated May 8,2019.

S/N: XXXXXXXXXX

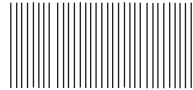

mm dd, yyyy

HISENSE VISUAL TECHNOLOGY CO.,LTD.

NO. 218, QIANWANGANG ROAD, ECONOMY & TECHNOLOGY
DEVELOPMENT ZONE, QINGDAO, P.R. CHINA

Hisense LASER CINEMA



1324415 ES-A2417Z8-1