

Acer DLP Projector
PL3510ATV/FL251/LU-P251F/PF-L251F/
LR560ATV/ML-470ATV/PL3510Z/
HL6510ATV/HL6510Z/PL3511ATV/
PL3512ATV/HL6511ATV/HL6515ATV/
A1P2303/XL3510i/FL350/LU-P350F/PF-
L350F/LR560i/ML-470i/XL3511i/HL6510i/
HL6511i/A1P2301/HL6810ATV/EL8610a/
HL-4K10a/EL381/HL381/GL810a/VL-710a/
LR810a/ML-710a/PL3810Z/PL3810ATV/
HL6810AX/HL6811ATV/HL6810/EL8610/
HL-4K50/LU-P800K/HL380/GL810/VL-710/
LR810/ML-710/PL3810/PL3811/HL6810X/
HL6811/A4K2304/PL3510i/FL351/LU-
P351F/PF-L351F/LR561i/ML-471i/PL3510i/
HL6512i/HL6513i/A1P2302

Series User's Guide

Copyright © 2023. Acer Incorporated.
All Rights Reserved.

Acer Projector User's Guide
Original Issue: 08/2023

Changes may be made periodically to the information in this publication without obligation to notify any person of such revisions or changes. Such changes will be incorporated in new editions of this manual or supplementary documents and publications. This company makes no representations or warranties, either expressed or implied, with respect to the contents hereof and specifically disclaims the implied warranties of merchantability or fitness for a particular purpose.

Record the model number, serial number, purchase date and place of purchase information in the space provided below. The serial number and model number are recorded on the label affixed to your projector. All correspondence concerning your unit should include the serial number, model number and purchase information.

No part of this publication may be reproduced, stored in a retrieval system, or transmitted, in any form or by any means, electronically, mechanically, by photocopy, recording or otherwise, without the prior written permission of Acer Incorporated.

Acer Projector

Model number: _____

Serial number: _____

Date of purchase: _____

Place of purchase: _____

Acer and the Acer logo are registered trademarks of Acer Incorporated. Other companies' product names or trademarks are used herein for identification purposes only and belong to their respective companies.

The terms HDMI, HDMI High-Definition Multimedia Interface, HDMI Trade dress and the HDMI Logos are trademarks or registered trademarks of HDMI Licensing Administrator, Inc.

Information for Your Safety and Comfort

Read these instructions carefully. Keep this document for future reference. Follow all warnings and instructions marked on the product.

Turning the product off before cleaning

Unplug this product from the wall outlet before cleaning. Do not use liquid cleaners or aerosol cleaners. Use a damp cloth for cleaning.

Caution for plug as disconnecting device

Observe the following guidelines when connecting and disconnecting power to the external power supply unit:

- Install the power supply unit before connecting the power cord to the AC power outlet.
- Unplug the power cord before removing the power supply unit from the projector.
- If the system has multiple sources of power, disconnect power from the system by unplugging all power cords from the power supplies.

Caution for Accessibility

Be sure that the power outlet you plug the power cord into is easily accessible and located as close to the equipment operator as possible. When you need to disconnect power to the equipment, be sure to unplug the power cord from the electrical outlet.



Warnings!

- Do not use this product near water.
- Do not place this product on an unstable cart, stand or table. If the product falls, it could be seriously damaged.
- Slots and openings are provided for ventilation to ensure reliable operation of the product and to protect it from overheating. These openings must not be blocked or covered. The openings should never be blocked by placing the product on a bed, sofa, rug or other similar surface.

This product should never be placed near or over a radiator or heat register, or in a built-in installation unless proper ventilation is provided.

- Never push objects of any kind into this product through cabinet slots as they may touch dangerous voltage points or short-out parts that could result in a fire or electric shock. Never spill liquid of any kind onto or into the product.

- To avoid damage of internal components and to prevent battery leakage, do not place the product on a vibrating surface.
- Never use it under sporting, exercising, or any vibrating environment which will probably cause unexpected short current or damage rotor devices.

Using electrical power

- This product should be operated from the type of power indicated on the marking label. If you are not sure of the type of power available, consult your dealer or local power company.
- Do not allow anything to rest on the power cord. Do not locate this product where people will walk on the cord.
- If an extension cord is used with this product, make sure that the total ampere rating of the equipment plugged into the extension cord does not exceed the extension cord ampere rating. Also, make sure that the total rating of all products plugged into the wall outlet does not exceed the fuse rating.
- Do not overload a power outlet, strip or receptacle by plugging in too many devices. The overall system load must not exceed 80% of the branch circuit rating. If power strips are used, the load should not exceed 80% of the power strip's input rating.
- This product's AC adapter is equipped with a three-wire grounded plug. The plug only fits in a grounded power outlet. Make sure the power outlet is properly grounded before inserting the AC adapter plug. Do not insert the plug into a non-grounded power outlet. Contact your electrician for details.



.....
Warning! The grounding pin is a safety feature. Using a power outlet that is not properly grounded may result in electric shock and/or injury.



.....
Note: The grounding pin also provides good protection from unexpected noise produced by other nearby electrical devices that may interfere with the performance of this product.

- Use the product only with the supplied power supply cord set. If you need to replace the power cord set, make sure that the new power cord meets the following requirements: detachable type, UL listed/CSA certified, VDE approved or its equivalent, 4.5 meters (14.76 feet) maximum length.

Product servicing

Do not attempt to service this product yourself, as opening or removing covers may expose you to dangerous voltage points or other risks. Refer all servicing to qualified service personnel.

Unplug this product from the wall outlet and refer servicing to qualified service personnel when:

- the power cord or plug is damaged, cut or frayed
- liquid was spilled into the product
- the product was exposed to rain or water
- the product has been dropped or the case has been damaged
- the product exhibits a distinct change in performance, indicating a need for service
- the product does not operate normally after following the operating instructions



.....

Note: Adjust only those controls that are covered by the operating instructions, since improper adjustment of other controls may result in damage and will often require extensive work by a qualified technician to restore the product to normal condition.



.....

Warning! For safety reasons, do not use non-compliant parts when adding or changing components. Consult your reseller for purchase options.

Your device and its enhancements may contain small parts. Keep them out of the reach of small children.

Additional safety information

- Do not look into the projector's lens when the light source is on. The bright light may hurt your eyes.



RG2 IEC/EN 62471-5:2015

- Turn on the projector first and then signal sources.
- Do not place the product in the following environments:
 - Space that is poorly ventilated or confined. At least 50cm clearance from walls and free flow of air around the projector are necessary.
 - Locations where temperatures may become excessively high, such as inside of a car with all windows rolled up.
 - Locations where excessive humidity, dust, or cigarette smoke may contaminate optical components, shorten the life span and darken the image.
 - Locations near fire alarms.
 - Locations with an ambient temperature above 40 °C/104 °F. Such environment

may cause the fan(s) to operate in standby mode.

- Locations where the altitudes are higher than 10000 feet.
- Unplug immediately if there is something wrong with your projector. Do not operate if smoke, strange noise or odor comes out of your projector. It might cause fire or electric shock. In this case, unplug immediately and contact your dealer.
- Do not keep using this product to break or drop it. In this case contact your dealer for inspection.
- Do not face the projector lens to the sun. It can lead to fire.
- When switching the projector off, please ensure the projector completes its cooling cycle before disconnecting power.
- Do not frequently turn off the main power abruptly or unplug the projector during operation. The best way is to wait for the fan to stop before turning main power off.
- Do not touch the air outlet grille and bottom plate which become hot.
- Clean the air filter frequently. The temperature inside may rise and cause damage when the filter/ventilation slots are clogged with dirt or dust.
- Do not look into the air outlet grille when projector is operating. It may hurt your eyes.
- Always open the lens shutter or remove the lens cap when the projector is on.
- Do not block the projector lens with any object when the projector is under operation as this could cause the object to become heated and deformed or even cause a fire. To temporarily turn off the light source, press HIDE on the remote control.
- Do not attempt to disassemble this projector. There are dangerous high voltages inside which may hurt you.
- Do not stand the projector on end vertically. It may cause the projector to fall over, causing injury or damage.
- This product is capable of displaying inverted images for ceiling mount installation. Only use acer ceiling mount kit for mounting the projector and ensure it is securely installed.
- The projector should be placed in a horizontal way by means of desktop or ceiling mount mode only, and its tilt angles should not exceed 6 degrees, otherwise it would cause dramatical decrease of lamp life or severe safety concern of system malfunction.



Caution for Listening

To protect your hearing, follow these instructions.

- Increase the volume gradually until you can hear clearly and comfortably.
- Do not increase the volume level after your ears have adjusted.
- Do not listen to music at high volumes for extended periods.
- Do not increase the volume to block out noisy surroundings.
- Decrease the volume if you can't hear people speaking near you.

Disposal instructions

Do not throw this electronic device into the trash when discarding. To minimize pollution and ensure utmost protection of the global environment, please recycle. For more information on the Waste from Electrical and Electronics Equipment (WEEE) regulations, visit

<http://www.acer-group.com/public/Sustainability/index.htm>



Laser caution

IEC 60825-1:2014: CLASS 1 LASER PRODUCT - RISK GROUP 2.

The product's intended use as a consumer laser product and compliant with EN 50689:2021.

CLASS 1 CONSUMER LASER PRODUCT

EN 50689:2021



- Notice is given to supervise children and to never allow them to stare into the projector beam at any distance from the projector.
- Notice is given to use caution when using the remote control for starting the projector while in front of the projection lens.
- Notice is given to the user to avoid the use of optical aids such as binoculars or telescopes inside the beam.

First Thing First

Usage Notes

Do:

- Turn off the product before cleaning.
- Use a soft cloth moistened with mild detergent to clean the display housing.
- Disconnect the power plug from AC outlet if the product is not being used for a long period of time.

Don't:

- Block the slots and openings on the projector provided for ventilation.
- Use abrasive cleaners, waxes or solvents to clean the unit.
- Use under the following conditions:
 - In extremely hot, cold or humid environments.
 - In areas susceptible to excessive dust and dirt.
 - Near any appliance that generates a strong magnetic field.
 - Place in direct sunlight.

Precautions

Follow all warnings, precautions and maintenance as recommended in this user's guide to maximize the life of your unit.



.....

Warning:

- Do not look into the projector's lens when the projector is on. The bright light may hurt your eyes.
- To reduce the risk of fire or electric shock, do not expose this product to rain or moisture.
- Please do not open or disassemble the product as this may cause electric shock.
- When switching the projector off, please ensure the projector completes its cooling cycle before disconnecting power.
- Turn on the projector first and then the signal sources.
- Do not use lens cap when projector is in operation.

| | |
|---|------|
| Information for Your Safety and Comfort | iii |
| First Thing First | viii |
| Usage Notes | viii |
| Precautions | viii |
| Introduction | 1 |
| Product Features | 1 |
| Package Overview | 2 |
| Projector Overview | 3 |
| Projector Outlook | 3 |
| Control Panel | 4 |
| Remote Control Layout | 5 |
| Getting Started | 7 |
| Connecting the Projector | 7 |
| Turning the Projector On/Off | 9 |
| Turning On the Projector | 9 |
| Turning Off the Projector | 10 |
| Adjusting the Projected Image | 11 |
| Adjusting the Height of the Projected Image | 11 |
| How to Get a Preferred Image Size by Adjusting Distance and Zoom | 12 |
| How to Get a Preferred Image Position by Adjusting Lens Shift (only for selected models) | 14 |
| User Controls | 15 |
| Installation Menu | 15 |
| Onscreen Display (OSD) Menus | 16 |
| Color | 17 |
| Image | 20 |
| Setting | 23 |
| Management | 28 |
| Audio | 30 |
| 3D | 31 |
| Language | 32 |
| Acer Splash Downloader | 33 |

Contents

| | |
|---------------------------------------|-----------|
| Introduction | 33 |
| Using the Acer Splash Downloader | 33 |
| Appendices | 36 |
| Troubleshooting | 36 |
| LED & Alarm Definition Listing | 40 |
| Ceiling Mount Installation | 41 |
| Specifications | 44 |
| Compatibility Modes | 47 |
| Regulations and safety notices | 49 |

Introduction

Product Features

This product is a single-chip DLP® projector, including the following outstanding features:

- DLP® technology
- Enables projecting 3D content via DLP Link Technology: Blu-Ray 3D supported
- Acer ColorBoost technology delivers vivid, life-like images
- High brightness and contrast ratio
- Versatile display modes enable optimum performance in any situation
- HDTV (720p, 1080i, 1080p) supported
- Lower power consumption and economy (ECO) mode extends projector life
- Acer EcoProjection Technology delivers Intelligent power management approach and physical efficiency improvement
- Advanced keystone correction delivers optimum presentations
- Multi-language Onscreen Display (OSD) menus
- Manual focus/zoom projection lens
- 0.8 ~ 2X digital zoom and pan move function
- Microsoft® Windows® 2000, XP, 7, 8, 8.1, 10, Vista®, Macintosh OS, Chrome OS compliant
- CEC (Consumer Electronics Control) function supported
- BluelightShield function supported
- Adjustable light source power
- The projector supports 32:9 aspect ratio when you change the output resolution of your device to 3840 x 1080 respectively. Unsupported devices: HDMI 1.4 sources do not support 3840 x 1080. Device compatibility: HDMI 2.0 sources with Intel graphics card.

Package Overview

This projector comes with all the items shown below. Check to make sure you have them all. Contact your dealer immediately if any thing is missing.

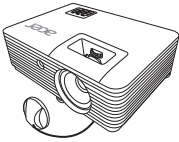

Projector

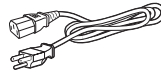
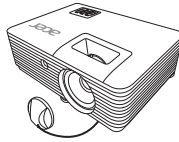

Power cord



HDMI cable
(Optional)



Security card
(Optional)

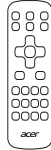

Remote control



Quick start guide



AAA Battery x 2



Carrying case
(Optional)



Wireless dongle
(UWA5) (Optional)



Android TV
dongle (Optional)



Additional AAA
Battery x 2 (for
models with
Android TV
dongle)



Note: The package content may differ by regions and models.

Projector Overview

Projector Outlook

Front/upper side

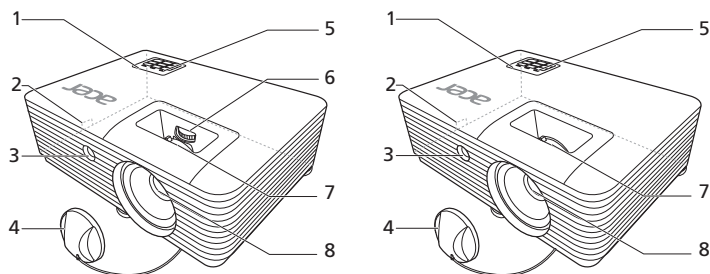

| # | Description | # | Description |
|---|-------------------------|---|-----------------------------------|
| 1 | Control panel | 5 | Power key and Power indicator LED |
| 2 | Security slot | 6 | Lens shift knob |
| 3 | Remote control receiver | 7 | Zoom ring and Focus ring |
| 4 | Lens cap | 8 | Projection lens |

Rear side

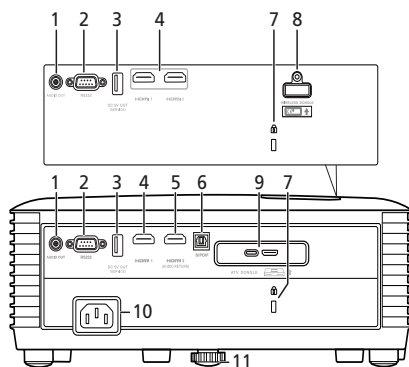

Note: Connector interface is subject to model's specifications.

| # | Description | # | Description |
|---|--------------------------------|----|---|
| 1 | Audio output connector | 8 | USB A connector (for wireless dongle) |
| 2 | RS232 connector | 9 | USB type-C and HDMI connector (for Android TV dongle) |
| 3 | USB A connector (DC 5V output) | 10 | Power socket |
| 4 | HDMI connector(s) | 11 | Tilt adjusting wheel |
| 5 | HDMI connector (audio return) | | |
| 6 | S/PDIF port | | |
| 7 | Kensington™ lock port | | |

Control Panel

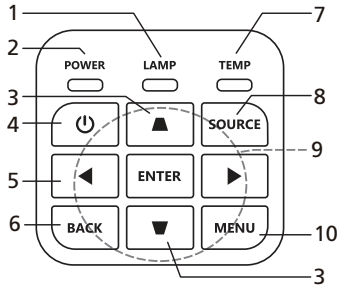

| # | Function | Description |
|----|---------------------------------|--|
| 1 | LAMP | Lamp indicator LED. |
| 2 | POWER | Power indicator LED |
| 3 | Keystone | Adjusts image distortion caused by tilting projection. |
| 4 | Power key | Refer to the "Turning the Projector On/Off" section. |
| 5 | ENTER | Confirms your selection of items. |
| 6 | BACK | Cancels your selection, or goes back to previous page. |
| 7 | TEMP | Temperature indicator LED. |
| 8 | SOURCE | Changes the active source. |
| 9 | Four directional selection keys | Selects items or makes adjustments to your selection |
| 10 | MENU | Launches the Onscreen Display (OSD) menu, returns to the previous step for the OSD menu operation or exits the OSD menu. |

Remote Control Layout

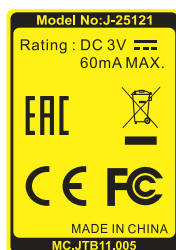
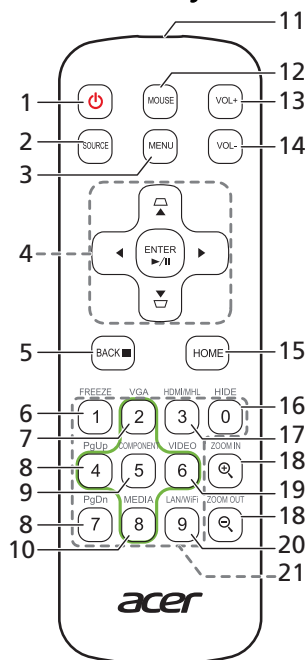

| # | Function | Description |
|---|---------------------------------|--|
| 1 | POWER | Refer to the "Turning the Projector On/Off" section. |
| 2 | SOURCE | Changes the active source. |
| 3 | MENU | Launches the Onscreen Display (OSD) menu or exits the OSD menu. |
| 4 | Keystone | Adjusts image distortion caused by tilting projection. |
| | Four directional selection keys | Selects items or makes adjustments to your selection. |
| | ENTER ▶/ Play/Pause | Confirms your selection of items. |
| 5 | BACK | Cancels your selection, or goes back to previous page. |
| | ■ Stop | |
| 6 | FREEZE | To pause the screen image. |
| 7 | VGA | To change source to VGA. This connection supports analog RGB, and YPbPr (480i/480p/576i/576p/720p/1080i/1080p). (for the model with VGA connector) |

| # | Function | Description |
|----|----------------------|---|
| 8 | PgUp/PgDn | For computer mode only. Use this button to select the next or previous page. This function is only available when connected to a computer via a mini USB cable. |
| 9 | COMPONENT | (No function) |
| 10 | MEDIA | Opens MEDIA SETUP page. (for LAN/wireless compatible models) |
| 11 | Infrared transmitter | Sends signals to the projector. |
| 12 | MOUSE | (No function) |
| 13 | VOL+ | Increases the projector's volume. |
| 14 | VOL- | Decreases the projector's volume. |
| 15 | HOME | (No function) (for models without Android TV dongle) Returns to the home screen of the Android TV dongle. |
| 16 | HIDE | Press "HIDE" to hide screen image; press again to display the image. |
| 17 | HDMI/MHL | To change source to HDMI™ (or MHL). (for the model with HDMI™ or MHL connector) |
| 18 | ZOOM IN/ZOOM OUT | Zooms the projector display in or out. |
| 19 | VIDEO | To change source to composite video. (for the model with VIDEO connector) |
| 20 | LAN/WiFi | To change source to LAN/WiFi. (for LAN/wireless compatible models) |
| 21 | Keypad 0~9 | Press " 0~9 " to input a password in the "Setting" > "Security" OSD. |

Getting Started

Connecting the Projector

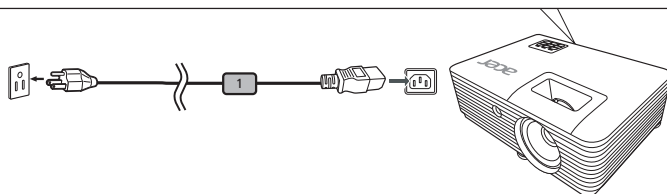
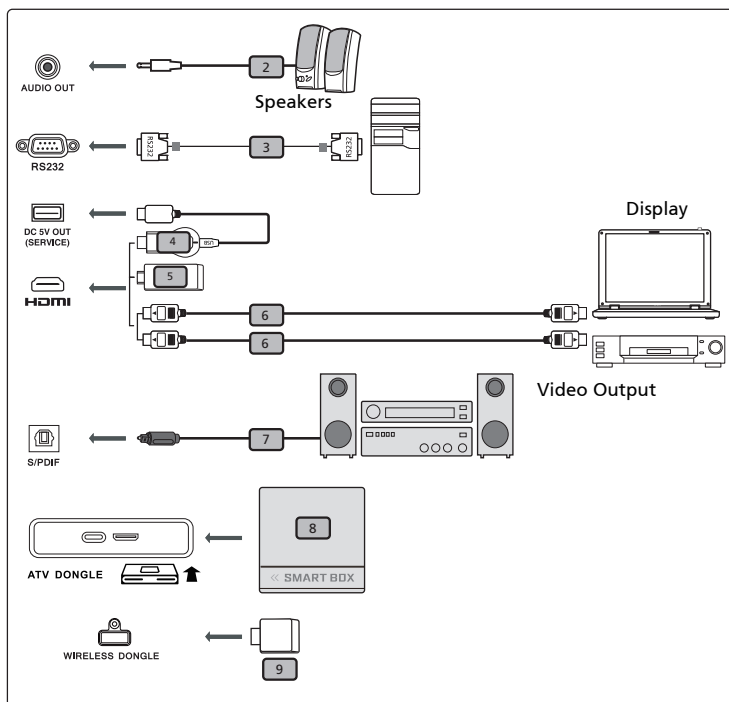

Note: Connector interface is subject to model's specifications.

| # | Description | # | Description |
|---|-------------------|---|--------------------|
| 1 | Power cord | 6 | HDMI cable |
| 2 | Audio cable | 7 | S/PDIF audio cable |
| 3 | RS232 cable | 8 | Android TV dongle |
| 4 | HDMI dongle | 9 | Wireless dongle |
| 5 | WirelessHD dongle | | |



Note: To ensure the projector works well with your computer, please make sure the timing of the display mode is compatible with the projector.

Note: Compatible HDMI dongles: WirelessHD (MWIHD1), MWA3, HWA1, Chromecast™.

Turning the Projector On/Off

Turning On the Projector

- 1 Ensure that the power cord and signal cable are securely connected. The Power LED will light red.
- 2 Turn on the projector by pressing  (POWER) on the control panel or remote control, and the Power indicator LED will turn blue.
- 3 Turn on your source (computer, notebook, video player, etc.). The projector will detect your source automatically (when it is the first time you turn on the projector or the Source Selection function is "Auto").
 - If the screen displays "No Signal", please make sure the signal cables are securely connected.
 - If you connect to multiple sources at the same time, use "SOURCE" on the control panel or remote control, or the direct source key on the remote control to switch between inputs.
 - When there is no signal while you are using the Android TV dongle, press the power button on the remote control of the Android TV dongle to turn on the Android TV dongle, or restart the projector to recover the Android TV output.
 - If the remote control of the Android TV dongle does not respond, press the reset button on the Android TV dongle to reset it and pair it with the remote control again.

Turning Off the Projector

- 1 To turn the projector off, press the power button. This message appears:
"Please press power button again to complete the shutdown process"
 Press the power button again.
- 2 The LED Power indicator will turn solid red to indicate standby mode.
- 3 It is now safe to unplug the power cord.



Warning indicators:

- **"Projector Overheated. Light source will automatically turn off soon."**
 This onscreen message indicates that the projector has overheated. The lamp will automatically turn off, the projector will automatically shut down, and the LED Temp indicator will turn solid red. Contact your local dealer or service center.
- **"Fan failed. Light source will automatically turn off soon."**
 This onscreen message indicates that the fan has failed. The lamp will automatically turn off, the projector will automatically shut down, and the LED Temp indicator will blink. Contact your local dealer or service center.



Note: Whenever the projector automatically shuts down and the LED Temp indicator turns solid red, contact your local reseller or service center.

Adjusting the Projected Image

Adjusting the Height of the Projected Image

The projector is equipped with elevator feet for adjusting the image height.

To raise the image:

- 1 Use the front Tilt adjusting wheel to raise the image to the desired height and angle.
- 2 Use the rear Tilt adjusting wheel to fine-tune the display angle.

To lower the image:

- 1 Use the front Tilt adjusting wheel to lower the image to the desired height and angle.
- 2 Use the rear Tilt adjusting wheel to fine-tune the display angle.

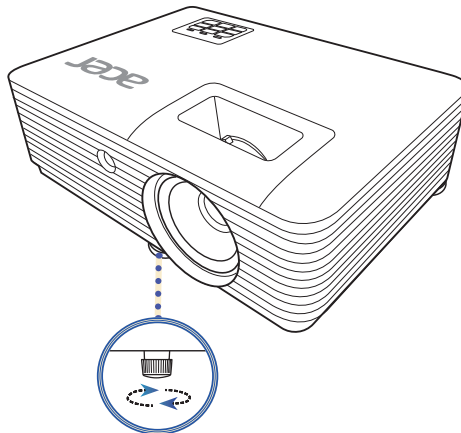

Tilt adjusting wheel

How to Get a Preferred Image Size by Adjusting Distance and Zoom

The table below shows how to achieve a desired image size by adjusting either the position or the zoom ring.

- 1080p/4K series with a zoom ratio of 1.3x and a throw ratio of 1.15 – 1.5
To obtain an image size of 100", set the projector at a distance between 2.5 m and 3.3 m from the screen and adjust the zoom level accordingly.

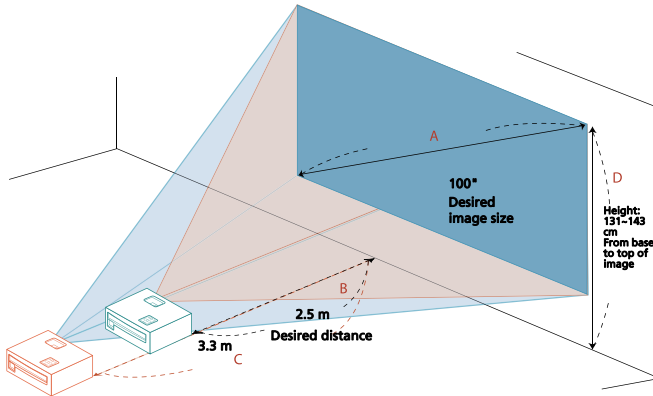

| Desired Image Size | | Distance (m) | | Top (cm) | |
|-----------------------|-----------------|----------------|----------------|---------------------------------|--------------|
| Diagonal (inch) < A > | W (cm) x H (cm) | Max zoom < B > | Min zoom < C > | From base to top of image < D > | |
| | | | | Offset: 110% | Offset: 130% |
| 30 | 66 x 37 | 0.8 | 1.0 | 39 | 43 |
| 40 | 89 x 50 | 1.0 | 1.3 | 52 | 57 |
| 50 | 111 x 62 | 1.3 | 1.7 | 65 | 72 |
| 60 | 133 x 75 | 1.5 | 2.0 | 78 | 86 |
| 70 | 155 x 87 | 1.8 | 2.3 | 92 | 100 |
| 80 | 177 x 100 | 2.0 | 2.7 | 105 | 115 |
| 90 | 199 x 112 | 2.3 | 3.0 | 118 | 129 |
| 100 | 221 x 125 | 2.5 | 3.3 | 131 | 143 |
| 120 | 266 x 149 | 3.1 | 4.0 | 157 | 172 |
| 150 | 332 x 187 | 3.8 | 5.0 | 196 | 215 |
| 180 | 398 x 224 | 4.6 | 6.0 | 235 | 258 |
| 200 | 443 x 249 | 5.1 | 6.6 | 262 | 286 |
| 250 | 553 x 311 | 6.4 | 8.3 | 327 | 358 |
| 300 | 664 x 374 | 7.6 | 10.0 | 392 | 430 |

- 1080p series with a zoom ratio of 1.1x and a throw ratio of 1.49 – 1.64
To obtain an image size of 100", set the projector at a distance between 3.3 m and 3.6 m from the screen and adjust the zoom level accordingly.

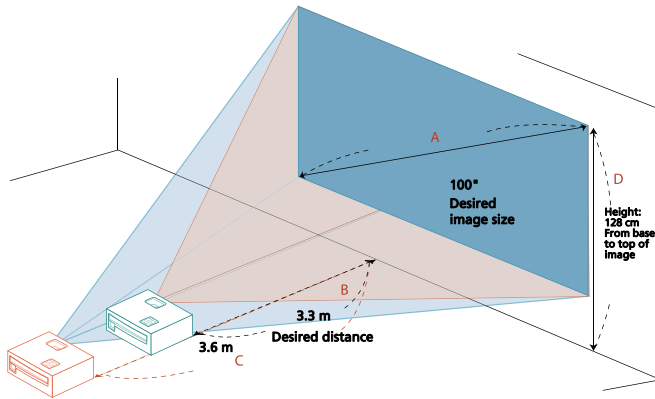

| Desired Image Size | | Distance (m) | | Top (cm) |
|--------------------------|-----------------|-------------------|-------------------|------------------------------------|
| Diagonal (inch) < A > | W (cm) x H (cm) | Max zoom < B > | Min zoom < C > | From base to top of image < D > |
| 30 | 66 x 37 | 1.0 | 1.1 | 38 |
| 40 | 89 x 50 | 1.3 | 1.5 | 51 |
| 50 | 111 x 62 | 1.6 | 1.8 | 64 |
| 60 | 133 x 75 | 2.0 | 2.2 | 77 |
| 70 | 155 x 87 | 2.3 | 2.5 | 90 |
| 80 | 177 x 100 | 2.6 | 2.9 | 103 |
| 90 | 199 x 112 | 3.0 | 3.3 | 115 |
| 100 | 221 x 125 | 3.3 | 3.6 | 128 |
| 120 | 266 x 149 | 4.0 | 4.4 | 154 |
| 150 | 332 x 187 | 4.9 | 5.4 | 192 |
| 180 | 398 x 224 | 5.9 | 6.5 | 231 |
| 200 | 443 x 249 | 6.6 | 7.3 | 257 |
| 250 | 553 x 311 | 8.2 | 9.1 | 321 |
| 300 | 664 x 374 | 9.9 | 10.9 | 385 |

How to Get a Preferred Image Position by Adjusting Lens Shift (only for selected models)

The projector is equipped with lens shift for adjusting the position of projected image without requiring you to physically move the projector. To shift the lens, turn the knob on the top of the projector.



Note: The figures shown in this section are for reference only not approximate value. The figures between units can be different due to assembly tolerance.

The vertical height can be adjusted between +55% and +65% of the image height.

The vertical position

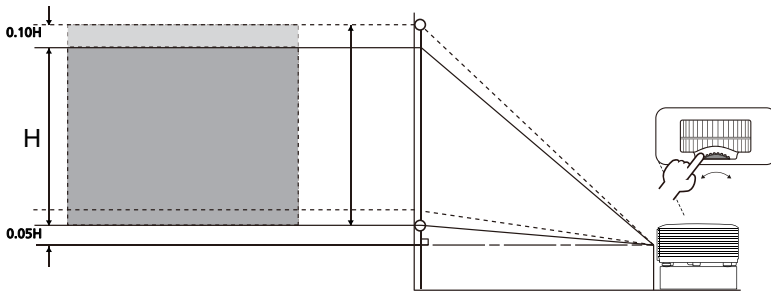

User Controls

Installation Menu

The Installation menu provides an Onscreen Display (OSD) for projector installation and maintenance. Use the OSD only when the message "No signal" is displayed on the screen or when the projector searches for input signal.

- 1 Turn on the projector by pressing  (POWER) on the control panel or remote control.
- 2 Press "MENU" on the control panel or remote control to launch the OSD for projector installation and maintenance.

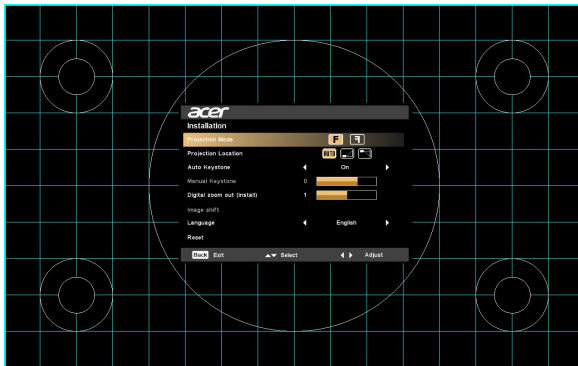

- 3 The background pattern acts as a guide to adjusting the calibration and alignment settings, such as screen size and distance, focus and more.



Note: The OSD screenshot is for reference only and may differ from the actual design.

- 4 The Installation menu includes several options.
Use the up and down arrow keys to select an option, the left and right arrow keys to adjust selected option settings, and the right arrow key to enter a submenu for feature setting. The new settings will be saved automatically upon exiting the menu.
- 5 Press "MENU" anytime to exit the menu and return to the Acer welcome screen.

Onscreen Display (OSD) Menus

The projector has multilingual Onscreen Display (OSD) menus that allow you to make image adjustments and change a variety of settings.

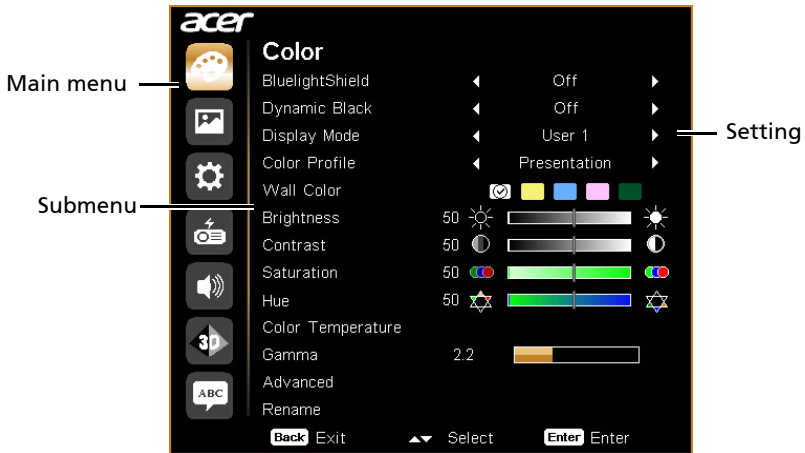

Using the OSD menus

- To open the OSD menu, press "MENU" on the control panel or remote control.
- When the OSD is displayed, use ▲ ▼ to select an item in the main menu. After selecting the desired main menu item, press ▶ to enter a submenu for feature setting.
- Use ▲ ▼ to select the desired item and adjust the settings by using ◀ ▶.
- Select the next item to be adjusted in the submenu and adjust as described above.
- Press "MENU" on the control panel or remote control, the screen will return to the main menu.
- To exit the OSD menu, press "MENU" on the control panel or remote control again. It will close and the projector will automatically save the new settings.



Note: Some of the following OSD settings may not be available. Please refer to the actual OSD of your projector.







Color





| | |
|------------------------|--|
| BluelightShield | <p>This function protects your eyes from over-exposure to blue light. The options are Off, Low, Medium, and High. Choose a preferred setting to reduce the level of blue light and get a comfortable viewing experience.</p>  <p>.....</p> <p>When this function is enabled, LumiSense will be automatically set to "Off".</p> |
| Dynamic Black | <p>The projector can intelligently optimizes the brightness and color saturation of projected image. The feature greatly enhances dark detail visibility and color saturation.</p> <ul style="list-style-type: none"> • Off: For normal mode. • On: Automatically optimizes the display of dark movie scenes enabling them to be shown in incredible detail.  <p>.....</p> <p>This function is unavailable when 3D is set to "On" .</p> |
| Display Mode | <p>There are many factory presets optimized for various types of images.</p> <ul style="list-style-type: none"> • Bright: For brightness optimization. • Presentation: For meeting presentation with higher brightness. • Standard: For common environment. • Rec.709: For Rec. 709 standard. • Movie: For brighter and general movie/video/photo playing. • Dark Cinema: For dark movie content. • Game: For game content. • Football: For football game. • DICOM SIM: For DICOM format files in simulation mode, and not for actual diagnosis. • ISF Day/ISF Night: Only available when ISF is enabled. • User 1/User 2/User 3: Memorize user's settings. |
| Color Profile | <p>Available when User 1/User 2/User 3 is selected in the Display Mode menu. You can use one of the display modes as a starting point and customize the settings. The below OSD items can be adjusted and saved.</p> |

| | |
|--------------------------|--|
| Wall Color | Use this function to choose a proper color according to the wall. There are several choices, including White, Light Yellow, Light Blue, Pink and Dark Green. It will compensate for the color deviation due to the wall color to show the correct image tone. |
| Brightness | Adjusts the brightness of the image. <ul style="list-style-type: none"> • Press ◀ to darken the image. • Press ▶ to lighten the image. |
| Contrast | Controls the degree of difference between the lightest and darkest parts of the picture. Adjusting the contrast changes the amount of black and white in the image. <ul style="list-style-type: none"> • Press ◀ to decrease the contrast. • Press ▶ to increase the contrast. |
| Saturation | Adjusts a video image from black and white to fully saturated colors. <ul style="list-style-type: none"> • Press ◀ to decrease the amount of color in the image. • Press ▶ to increase the amount of color in the image. |
| Hue | Adjusts the color balance of red and green. <ul style="list-style-type: none"> • Press ◀ to increase the amount of green in the image. • Press ▶ to increase the amount of red in the image. |
| Color Temperature | Adjusts the color temperature. At higher color temperatures, the screen looks colder; at lower color temperatures, the screen looks warmer. |
| Gamma | Effects the representation of dark scenery. With greater gamma value, dark scenery will look brighter. |

| | |
|-----------------|--|
| Advanced | <ul style="list-style-type: none"> • Ind. Color Management: Adjusts the red, green, blue, cyan, yellow and magenta colors. • - Ind. Hue: Changes the hue of the color selected. • - Ind. Saturation: Adjusts a video image from black and white to fully saturated color. • - Ind. Gain: Adjusts the contrast levels. • Brilliant Color: Produces an expanded on-screen color spectrum that delivers enhanced color saturation for bright, true-to-life images. This feature is "On" by default. • White Peaking: Increases the brightness of whites that are near 100%. (Video sources only) • Film Mode: Sets the image optimized to 24-frame True Film mode for more realistic cadence of film playback during motion sequences. • ISF: This menu is password protected and only accessible by authorized calibrators. The ISF (Imaging Science Foundation) has developed carefully crafted, industry-recognized standards for optimal video performance and has implemented a training program for technicians and installers to use these standards to obtain optimal picture quality ISF certified display devices. Accordingly, we recommend that setup and calibration be performed by an ISF certified installation technician. For more information, go to www.imagingscience.com or contact the dealer or retailer from whom you purchased the projector. |
| Rename | Available when User 1/User 2/User 3 is selected in the Display Mode menu. You can change User 1/User 2/User 3 to your preferred mode name in English letters. |

Image

| | |
|----------------------------|---|
| Projection Mode | <ul style="list-style-type: none"> •  Front: The factory default setting. •  Rear: Reverses the image so you can project from behind a translucent screen. |
| Projection Location | <ul style="list-style-type: none"> •  Auto: Automatically adjusts projection location of image. •  Desktop •  Ceiling: Turns the image upside down for ceiling-mounted projection. |
| Aspect Ratio | <p>Use this function to choose your desired aspect ratio.</p> <ul style="list-style-type: none"> • Auto: Keeps the image with original width-height ratio and maximizes the image to fit native horizontal or vertical pixels. • Full (for WXGA/1080p models): The image will be displayed making full use of the horizontal and vertical pixels. • 4:3: The image will be scaled to fit the screen and displayed using a 4:3 ratio. • 16:9: The image will be scaled to fit the screen and displayed using a 16:9 ratio. • L.Box (for WXGA/1080p models): Keeps the original signal aspect ratio and zooms in by 1.333 times. |
| Auto Keystone | <p>Automatically adjusts image distortion caused by tilting projection.</p> |
| Manual Keystone | <p>Manually adjusts image distortion caused by tilting projection.</p> <div style="text-align: center;">  </div> <div style="margin-top: 10px;">  </div> <p>This function is unavailable when Auto Keystone is set to "On".</p> |

| | |
|---------------------|---|
| H/V Keystone | <p>Auto V. Keystone Automatically adjusts vertical image distortion caused by tilting projection.</p> |
| | <p>V. Keystone Manually adjusts image distortion caused by tilting projection.</p>  |
| 4 Corner Correction | <p>H. Keystone Manually adjusts image distortion caused by tilting projection.</p>  |
| | <p>Manually adjusts the shape and size of an image that is unevenly rectangular on all sides. Press "MODE" repeatedly to select the corner that you wish to adjust. Press four directional selection keys to adjust the image shape.</p>  <p></p> <p>Please adjust 4-corner correction separately for each aspect ratio, and its memory is allowed to save 4 sets of settings only.</p> |

| | |
|--|--|
| <p>Warping</p> |  <p>-----</p> <p>Note: Some of the following OSD settings may not be available. Please refer to the actual OSD of your projector.</p> <p>The function is to configure the geometric distortion of the projector's images when the images are projected onto screens which have a kind of uneven surface such as a cylinder, a spherical shape, etc.</p> <p>Enable Keystone and corner correction functions will not be available when Warping is enabled.</p> <p>Control Method Allows you to select a preferred control method for warping adjustment.</p> <p>Warping Adj. This function is available when On is selected in the Warping > Enable menu and OSD is selected in the Warping > Control Method menu.</p> |
| <p>Digital Zoom Out (Install)</p> | <p>Sets the default size of the projected image. You can further zooms in or out the image by pressing ◀ ▶ . Using the functions of Digital Zoom Out and Image Shift together helps you fit the projected image full screen without adjusting the existing ceiling mount settings.</p> |
| <p>Image Shift</p> | <p>Shifts the projected image by pressing ◀▶ . When Native Resolution is WXGA, this functions is only available when the setting of Digital Zoom Out (Install) is less than 1.0.</p> |
| <p>Sharpness</p> | <p>Adjusts the sharpness of the image.</p> <ul style="list-style-type: none"> • Press ◀ to decrease the sharpness. • Press ▶ to increase the sharpness. |
| <p>HDMI Color Range</p> | <p>Adjusts the color range of the HDMI image data to prevent color display error.</p> <ul style="list-style-type: none"> • Auto: Automatically adjusts the color range by information from the player. • Limited Range: Processes the input image as limited color range data. • Full Range: Processes the input image as full color range data. |



| | |
|-----------------------|--|
| HDMI Scan Info | <p>Adjusts the overscan ratio of the HDMI image on screen.</p> <ul style="list-style-type: none"> • Auto: Automatically adjusts the overscan ratio by information from the player. • Underscan: Always no overscan on the HDMI image. • Overscan: Always keep overscan on the HDMI image. |
|-----------------------|--|



Note: "HDMI Color Range" and "HDMI Scan Info" are only available when the input signal is HDMI.

Setting

| | |
|-------------------------|--|
| HDR | <ul style="list-style-type: none"> • HDR: The projector supports HDR imaging sources. It can automatically detect the dynamic range of the source, and optimize settings to reproduce contents under wide range of light conditions. If the input source is not defined with dynamic range, you can also manually select HDR 10 or HLG for it. • EOTF: This function helps provide better image quality with options from low, middle to high. |
| Startup Screen | <p>Use this function to select your desired startup screen. If you change the setting, it will take effect when you exit the OSD menu.</p> <ul style="list-style-type: none"> • Acer: The default startup screen of your Acer projector. • User: Use the picture you transfer to the projector. See "Acer Splash Downloader" for how to transfer the picture. |
| USB Mode Switch | <ul style="list-style-type: none"> • Control: When selected, you can use the page up/page down function via the USB port. Firmware can also be updated via the USB port for service personnel. • Adaptor: When selected, the USB port can only output power for Chromecast. • Multimedia: When selected, multimedia reader via USB port is supported. |
| Source Selection | <ul style="list-style-type: none"> • Manual: When switching input signals, you need to press "SOURCE" on the control panel or remote control, or the direct source key on the remote control. • Auto: The projector will detect your source automatically. |

| | |
|-----------------------------|---|
| USB 5V (Standby) | <p>Selecting "On" enables the function. The MHL port(s) and the DC 5V out port/USB A port (if available) on the projector can output 5V power when the projector is turned on or in standby mode.</p> <p> -----</p> <p>Only MHL port(s) will provide power output when MHL port(s) and USB A port are both plugged.</p> |
| Low Input Lag | <p>This function is especially suitable for gaming environment. It reduces input to output latency and helps create a seamless experience.</p> <p> -----</p> <p>This function is only available for certain input timings. After turned on, performing Auto Keystone or adjusting the following settings will deactivate this function: Aspect ratio, Keystone, H. Position, V. Position, Frequency, HDMI Scan Info, Digital Zoom. When Display Mode is Game Dark or Game Bright, this function will be automatically turned on.</p> |

| | |
|-----------------|---|
| Security | <p>Security</p> <p>This projector provides a useful security function for the administrator to manage the projector.</p> <p>Press ► to change the "Security" setting. If the security function is enabled, you must enter "Administrator Password" first before changing the security setting.</p> <p style="text-align: center;">  </p> <p style="margin-left: 100px;">The factory default of "Administrator Password" is "1234".</p> <ul style="list-style-type: none"> • Select "On" to enable the security function. You have to enter password depending on the "Security Mode". Please refer to "User Password" section for details. • If "Off" is selected, you can switch on the projector without password. |
| | <p>Timeout (Min.)</p> <p>Once "Security" is set to "On", you can set timeout function.</p> <ul style="list-style-type: none"> • Press ◀ ► to select timeout duration. • The range is from 10 to 990 minutes. • When time is up, the projector will request you to enter the password again. • The factory default setting of "Timeout (Min.)" is "Off". • Once the security function is enabled, the projector will request you to enter password when switching on the projector. Both "User Password" and "Administrator Password" can be accepted for this dialogue. |

| | |
|-------------------|--|
| Security | <p>User Password</p> <ul style="list-style-type: none"> • Press ► to set up or change "User Password". • Use the numerical keys on the remote control to set the password and press "ENTER" to confirm. • To delete the digits, Press ◀ . • Enter the password again when you see "Confirm Password" displayed. • The password should be 4–8 digits in length. • If you select "Request password only after plugging power cord", you are requested to input the password every time the power cord is plugged. If you fail to enter the correct password within 20 minutes upon request, the projector will shut down automatically. • If you select "Always request password while projector turns on", you are requested to input the password every time the projector is turned on. If you fail to enter the correct password within 20 minutes upon request, the projector will shut down automatically. |
| | <p>Administrator Password</p> <p>You can enter "Administrator Password" when the "Enter Administrator Password" or "Enter Password" dialogue box displays.</p> <ul style="list-style-type: none"> • Press ► to change "Administrator Password". • The factory default of "Administrator Password" is "1234". <p>If you forget your administrator password, do the following to retrieve the administrator password:</p> <ul style="list-style-type: none"> • Enter the unique 6-digit "Universal Password" which is printed on the Security Card that came with your projector. This unique password will be accepted by the projector no matter what the administrator password is. • If the Security Card is lost, please contact your local Acer service center. |
| | <p>Lock User Startup Screen</p> <p>This function is set to "OFF" by default. If set to "ON", the startup screen is locked and cannot be changed by the "Startup Screen" and "Screen Capture" functions.</p> |
| Reset WIFI | Press "ENTER" after choosing "Yes" to return the WIFI default settings. |

| | |
|-----------------|--|
| HDMI CEC | <p>Selecting "On" allows synchronized power ON/OFF operation between the projector and a CEC-compatible device connected to the HDMI/MHL port of the projector. When "HDMI CEC" and "RC Pass Through" are activated, the four directional selection keys and ENTER/BACK/HOME buttons can be used to control the Android TV dongle.</p>  <p>This function is only available for the HDMI/MHL port.</p> |
| Reset | <p>Press "ENTER" after choosing "Yes" to return the display parameters on all menus to the factory default settings.</p> |

Management

| | |
|------------------------------------|--|
| ECO Mode | Choose "ECO" to dim the projector lamp, which will also lower the power consumption, reduce noise, and extend the lamp life. Choose "User" allows you to adjust the light source power. Choose "Off" to return to the normal mode. |
| Light Source Power | This function is only available when "Custom" is selected in the ECO Mode menu. You can adjust the light source power to extend the light source life and decreases the fan noise. |
| High Altitude | Choose "On" to turn on the High Altitude mode. When this function is turned on, the projector fans operate at full speed continuously to cool down the projector's temperature. |
| Auto Shutdown (Minutes) | The projector will automatically shut down while there is no signal input detected after the time you set. |
| Menu Display Time (Seconds) | <ul style="list-style-type: none"> • 5/15/30: Chooses the length of time the OSD menu will remain active after your last key press. • Manual: The OSD menu remains active. The only way to launch or exit the OSD menu is by pressing "BACK". |
| Power Saving | <ul style="list-style-type: none"> • Extreme ECO (Minutes): Turns on to enter extreme low light source mode while there is no signal input detected after the time you set. • Quick Resume (Light Off): Turns on to enter light off state to save power while there is no signal input detected after the time you set. • Auto Shutdown (Minutes): The projector will automatically shut down while there is no signal input detected after the time you set. |
| Auto Power On | AC Power On Selecting "On" enables the function. The projector will automatically turn on when power is supplied via the power cord. |
| | HDMI Power On Selecting "On" enables the function. The projector will automatically turn on when power is supplied via the power cord and the HDMI signal is supplied via the HDMI cable. |

| | |
|---------------------------|---|
| Control Panel Lock | <ul style="list-style-type: none"> • Off: Allows all keys on the control panel to operate normally. • Child Lock: Disables the Power key on the control panel when the projector is in standby mode to prevent it from being accidentally turned on. To turn the projector on, press and hold the Power key for 3 seconds. • Full Lock: Disables all keys on the control panel. If you turn off the projector without disabling the Full Lock function, the projector will still be in locked status the next time it is turned on. To disable Full Lock function, press and hold "POWER" on the control panel for 7 seconds and the Control Panel Lock will be set to "Off". When the projector is in standby mode, press and hold "POWER" on the control panel for 7 seconds to turn the projector on and the Control Panel Lock will be set to "Off". |
| Information | Displays current status of this projector. |

Audio

| | |
|----------------------------|---|
| Volume | <ul style="list-style-type: none"> • Press ◀ to decrease the volume. • Press ▶ to increase the volume. |
| Mute | <ul style="list-style-type: none"> • Choose "On" to turn mute on. • Choose "Off" to turn mute off. |
| Power On/Off Volume | Select this function to adjust the notification volume when turning the projector on/off. |
| Alarm Volume | Select this function to adjust the volume of any warning notifications. |
| Audio Output | <p>You can select the audio output from internal or external speakers.</p>  <p>.....</p> <p>To enjoy Audio Return sound effect, make sure to turn on the eARC/ARC function from your soundbar as well. Audio Return supports multi-audio outputs including 2.0, 5.1, 7.1 and Dolby Atmos to external audio system like soundbar.</p> |
| Audio Format | <p>This function provides different audio output formats to achieve the audio performance you desire.</p> <ul style="list-style-type: none"> • LPCM: Supports 2 channel audio output. • Multi-channel: Supports 5.1 channel audio output. • Multi-channel+: Supports Dolby Atmos audio output. |
| Audio Return Format | <p>This function provides different audio output formats to achieve the audio performance you desire.</p> <ul style="list-style-type: none"> • Auto: Automatically adjusts the audio return format. • LPCM: Supports 2 channel audio output. • Multi-channel: Supports 5.1 channel audio output. • Multi-channel+: Supports Dolby Atmos audio output. |



.....

Note: When audio output or audio format changes, image will re-synch.

Note: Internal speaker supports 2 channel LPCM format. Other audio outputs and formats will be bypassed out.

Note: Only "Multichannel+" format bypasses 192KHz audio to eARC receivers. Please make sure that 192KHz audio is supported by the audio receiver.

3D

| | |
|---------------------------|--|
| 3D | <p>Selects "On" to enable the 3D function supported by DLP 3D technology.</p> <ul style="list-style-type: none"> On: Select this item while using DLP 3D glasses, quad buffer (NVIDIA/ATI...) graphics card and HQFS format file or DVD with corresponding SW player. Off: Turns off the 3D mode. |
| 3D Format | If the 3D content is not displayed correctly, you can select a 3D format that suits the 3D content you are viewing and obtain the best result. |
| 24P 3D | Choose 96Hz or 144Hz for 24p 3D. |
| 3D L/R Invert | If you see a discrete or overlapping image while wearing DLP 3D glasses, you may need to execute "Invert" to get best match of left/right image sequence to get the correct image (for DLP 3D). |
| 3D Warning Message | <p>Choose "On" to display the 3D warning message.</p> <div style="border: 1px solid black; background-color: black; color: white; padding: 5px;"> <p>Note: 3D display is now enabled.</p> <ol style="list-style-type: none"> 1. Please make sure you have the correct 3D signals and glasses. 2. Remember to turn off 3D if you don't want to see 3D images. 3. If the 3D display isn't correct, please try to enable 3D L/R Invert. 4. Display mode options will be disabled while in 3D mode. </div> |



Note: Supported 3D signal timings:

| Signal source type | Supported timing |
|-------------------------------|--|
| Video/S-Video/Component video | HQFS 3D (480i@60Hz), 576i@50Hz |
| VGA/HDMI (PC mode) | 800 x 600@50/60/100/120Hz 1024 x 768@50/60/100/120Hz 1280 x 800@50/60/100/120Hz (RB) 1920 x 1080@50/60/100/120Hz |
| HDMI (Video mode) | HQFS 3D (480i@60Hz), 576i@50Hz, Frame Packing (1080p@23.98/24Hz, 720p@50/60Hz) Side-by-Side Horizontal (1080i@50/60Hz, 1080p@50/60Hz) Top-and-Bottom (720p@50/60Hz, 1080p@23.97/24Hz, 1080p@50/60Hz) |

It needs correct settings on graphics card 3D application program for correct 3D display.
Some timings may not be applicable for selected models.

Note: "3D L/R Invert" and "3D Format" are only available when "3D" is enabled.

Language

| | |
|-----------------|---|
| Language | Sets a language for the OSD menus. Use ▲ ▼ to select your preferred language. |
|-----------------|---|

Acer Splash Downloader

Introduction

Acer Splash Downloader allows you to upload your desired picture onto an Acer projector. You can select the picture as the startup screen via the projector's OSD menu.

System Requirements

| | |
|----------------------------|---|
| Maximum image size | 6 Mbytes |
| Maximum image resolution | 1920 x 1200 Recommended: Native resolution |
| Minimum image resolution | 800 x 600 |
| Maximum color bits | 24 bits |
| Image format | BMP, JPG, PNG |
| Supported operation system | Windows 7, 8, 8.1, 10 (32 / 64 Bit) |

Using the Acer Splash Downloader

1. Entering download mode

Long press the POWER and MENU buttons on the control panel simultaneously while plugging in the power cord until the LED indicator lights up red.

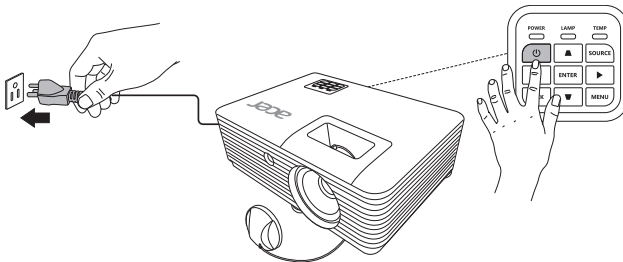

2. Connecting the computer to the projector

Use an USB cable to connect the computer and the projector.

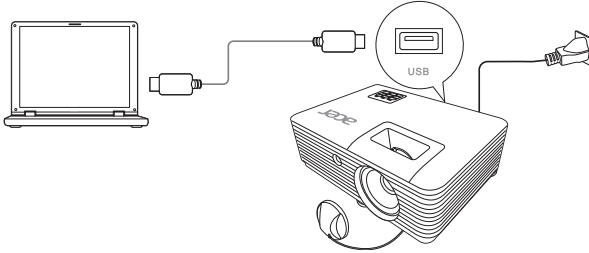

3. Executing the Acer Splash Downloader tool on the computer

If the projector is not properly connecting to the computer, below message will be displayed.

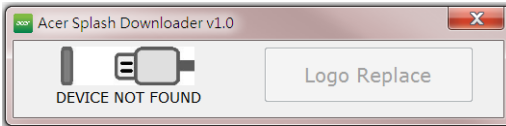

If the projector successfully connects the computer, below message will be displayed. Press "Logo Replace" to proceed.

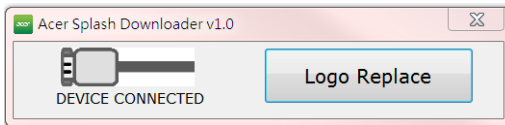

4. Loading the image

First, select the native resolution for the projector by adjusting "PJ Native Resolution" and decide if you want the image to be displayed full screen or in its original aspect ratio.

Press "LoadImage" and choose an image from your computer.

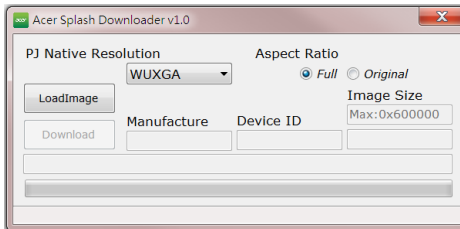

If the image is loaded successfully, the tool status will display "Load Image successfully".

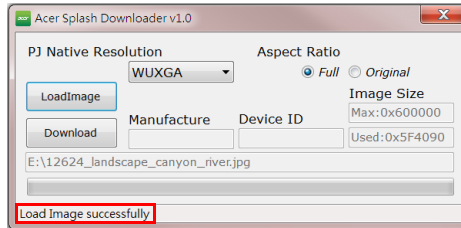

"Setting changed!! Please load image again." will be displayed in the tool status when PJ Native Resolution or aspect ratio is adjusted after the image is loaded successfully.

"Image size is over defined range" will be displayed in the tool status when the image is too large, and "Load Image fail" will be displayed when the image format is not supported.

5. Downloading the image to the projector

Press "Download" to start downloading the image to the projector.

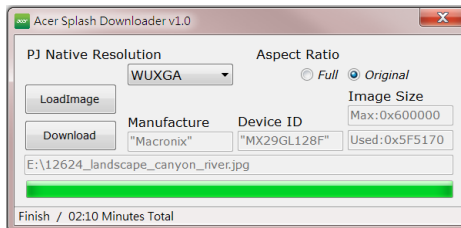

Note: If "Unknown" is shown in the Manufacture or Device ID field, the projector is not in a status suitable for download. Go back to step 1 and try again.

After the image is downloaded successfully, the projector will automatically shut down (enter standby mode), and the Startup Screen function in the OSD menu will be set to "User".

Appendices

Troubleshooting

If you experience a problem with your Acer projector, refer to the following troubleshooting guide. If the problem persists, please contact your local reseller or service center.

Image Problems and Solutions

| # | Problem | Solution |
|---|--|--|
| 1 | No image appears onscreen | <ul style="list-style-type: none"> • Make sure all the cables are correctly connected as described in the "Getting Started" section. • Ensure none of the connector pins are bent or broken. • Make sure the projector is switched on. |
| 2 | Partial, scrolling or incorrectly displayed image (For PC) | <ul style="list-style-type: none"> • For an incorrectly displayed image: <ul style="list-style-type: none"> • Open "My Computer > Control Panel," and then double-click the "Display" icon. • Select the "Settings" tab. • Verify that your display resolution setting is lower than or equal to 1600 x 1200 or 1920 x 1080. • Click the "Advanced Properties" button. • If the problem still appears, change the monitor display you are using and follow the steps below: <ul style="list-style-type: none"> • Verify that the resolution setting is lower than or equal to 1600 x 1200 or 1920 x 1080. • Click the "Change" button under the "Monitor" tab. • Click "Show all devices > Standard monitor types" under the SP box, and choose the resolution mode you need under the "Models" box. • Verify that the resolution setting of the monitor display is lower than or equal to 1600 x 1200 or 1920 x 1080. |

| | | |
|---|---|--|
| 3 | Partial, scrolling or incorrectly displayed image (For notebooks) | <ul style="list-style-type: none"> • For an incorrectly displayed image: <ul style="list-style-type: none"> • Follow the steps for item 2 (above) to adjust the resolution of your computer. • Press the toggle output settings. Example: [Fn]+[F4], Compaq [Fn]+[F4], Dell [Fn]+[F8], Gateway [Fn]+[F4], IBM [Fn]+[F7], HP [Fn]+[F4], NEC [Fn]+[F3], Toshiba [Fn]+[F5] • If you experience difficulty changing resolutions or your monitor freezes, restart all equipment including the projector. |
| 4 | The screen of the notebook computer is not displaying your presentation | <ul style="list-style-type: none"> • If you are using a Microsoft® Windows® based notebook: Some notebook PCs may deactivate their own screens when a second display device is in use. Each has a different way to be reactivated. Refer to your computer's manual for detailed information. • If you are using an Apple® Mac® OS based notebook: In System Preferences, open Display and select Video Mirroring "On." |
| 5 | Image is unstable or flickering | <ul style="list-style-type: none"> • Change the display color setting on your computer. |
| 6 | Image has vertical flickering bar | <ul style="list-style-type: none"> • Check and reconfigure the display mode of your graphics card to make it compatible with the projector. |
| 7 | Image is out of focus | <ul style="list-style-type: none"> • Adjust the focus settings. • Make sure the projection screen is within the required distance. (Refer to "Projection distance with clear focus" section for more information.) Refer to the "How to Get a Preferred Image Size by Adjusting Distance and Zoom" section for more information. |
| 8 | Image is stretched when displaying a "widescreen" DVD title | <p>When you play a DVD encoded in anamorphic or 16:9 aspect ratio you may need to adjust the following settings:</p> <ul style="list-style-type: none"> • If you play a 4:3 format DVD title, please change the format to 4:3 with the projector OSD. • If the image is still stretched, you will also need to adjust the aspect ratio. Set up the display format to 16:9 (wide) aspect ratio on your DVD player. |
| 9 | Image is too small or too large | <ul style="list-style-type: none"> • Adjust the zoom lever on the top of the projector. • Move the projector closer to or further from the screen. • Press "MENU" on the control panel or remote control. Go to "Image" > "Aspect Ratio" and try different settings. |

| | | |
|----|-------------------------|--|
| 10 | Image has slanted sides | <ul style="list-style-type: none"> • If possible, reposition the projector so that it is centered on the screen and below the bottom of the screen. • Press the Keystone correction keys on the control panel or remote control until the image becomes square. • Press "MENU" on the control panel or remote control to open the OSD menu. Go to "Image" > "Auto Keystone" or "Image" > "Manual Keystone" to make adjustments. |
| 11 | Image is reversed | <ul style="list-style-type: none"> • Select "Image" > "Projection Mode", "Image" > "Projection Location" on the OSD and adjust the projection direction. |
| 12 | The image abnormal | <ul style="list-style-type: none"> • Ensure the video source cable is connected properly, and that the video source is turned on. • If the above does not work, check that the air intake or exhaust is not blocked. |

Problems with the Projector

| # | Condition | Solution |
|---|--|---|
| 1 | The projector stops responding to all controls | <ul style="list-style-type: none"> • If possible, turn off the projector, then unplug the power cord and wait at least 30 seconds before reconnecting power. • Make sure that the control panel lock function is disabled. |
| 2 | Lamp burns out or makes a popping sound | When the lamp reaches the end of its useful life, it will burn out and may make a loud popping sound. If this happens, the projector will not turn on until the lamp module has been replaced. To replace the lamp, contact your local dealer or Acer service center. |

OSD Messages

| # | Condition | Message Reminder |
|---|-----------|---|
| 1 | Message | <p data-bbox="394 277 736 300">Fan Fail - the system fan is not working.</p> <div data-bbox="394 304 932 373" style="background-color: black; color: white; padding: 5px; text-align: center;"><p data-bbox="632 316 694 335">Fan Fail.</p><p data-bbox="497 339 828 359">Light source will automatically turn off soon.</p></div> <p data-bbox="394 387 929 451">Projector Overheated - the projector has exceeded its recommended operating temperature and must be allowed to cool down before it is used.</p> <div data-bbox="394 456 932 525" style="background-color: black; color: white; padding: 5px; text-align: center;"><p data-bbox="582 467 746 486">Projector Overheated.</p><p data-bbox="497 491 831 510">Light source will automatically turn off soon.</p></div> |

LED & Alarm Definition Listing

LED Messages

| Message | Power LED | | LAMP LED | TEMP LED |
|------------------------------------|----------------|----------------|----------------|----------------|
| | Red | Blue | Red | Red |
| Standby (Power cord plugged in) | V | -- | -- | -- |
| Power on | -- | V | -- | -- |
| Lamp retry | -- | Quick flashing | -- | -- |
| Turning off (Cooling state) | Quick flashing | -- | -- | -- |
| Turning off (Cooling completed) | V | -- | -- | -- |
| Firmware download | V | -- | V | V |
| Error (Thermal failure) | -- | V | -- | V |
| Error (Fan lock failure) | -- | V | -- | Quick flashing |
| Error (Lamp breakdown) | -- | V | V | -- |
| Error (Color wheel failure) | -- | V | Quick flashing | -- |

Ceiling Mount Installation

If you wish to install the projector using a ceiling mount, please refer to the steps below:

- 1 Drill four holes into a solid, structurally sound part of the ceiling, and secure the mount base.

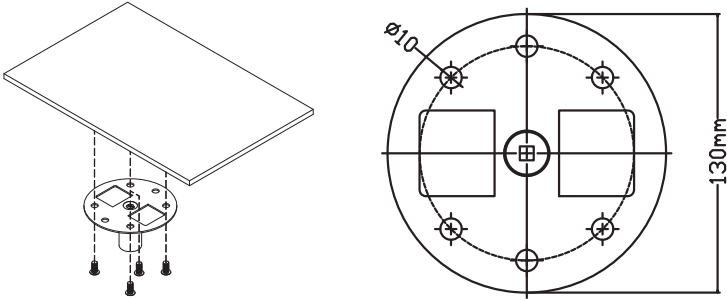

- 2 Choose the length combination based on actual environment. (CM-015 doesn't include Type 2 and Type 3.)

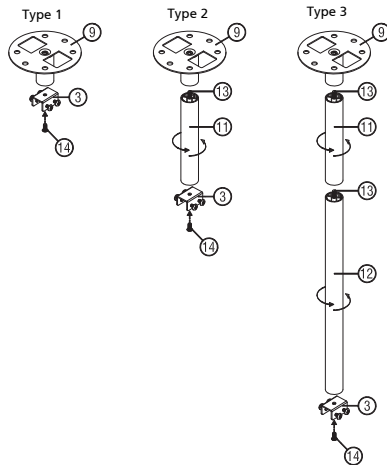

- 3 Type 1: For the standard size use three bracket screws to mount the projector to the ceiling mount bracket.

Type 2 and Type 3: Alternatively, for the larger size, use the sliding extensions for more supports.

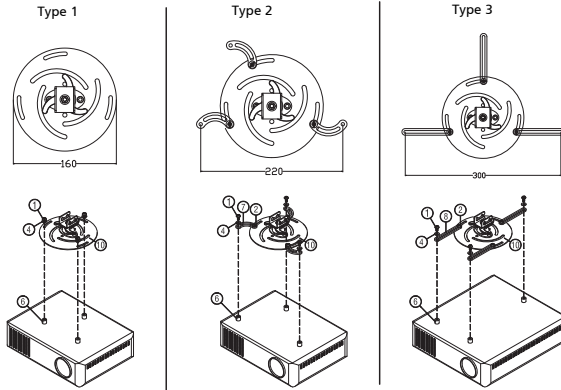

Note: It is recommended that you keep a reasonable space between the bracket and the projector to allow for proper heat distribution.

- 4 Connect the main body connector to the projector bracket (illustration 1), and then screw up four screws (illustration 2).

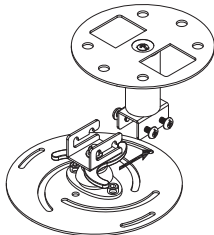

Illustration 1

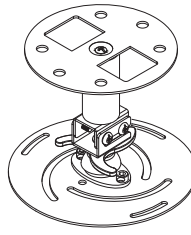
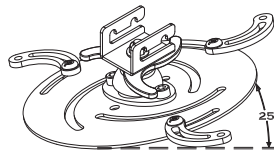
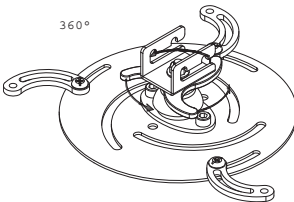
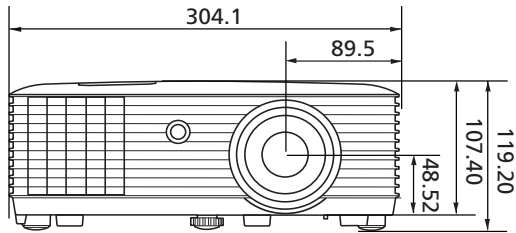
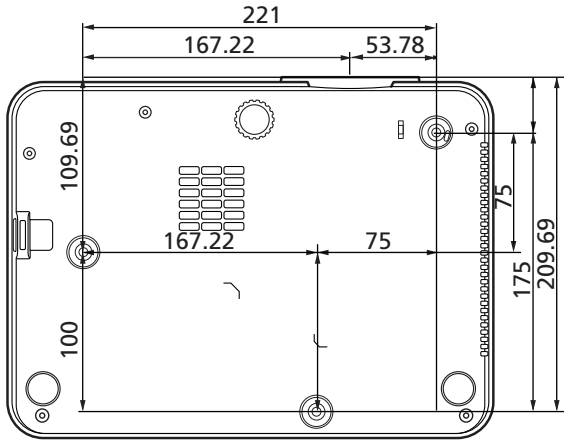

Illustration 2

- 5 Adjust the angle and positioning as necessary.



| Screw Type A | | Washer Type | |
|---------------|-------------|-------------|-------|
| Diameter (mm) | Length (mm) | Large | Small |
| 4 | 25 | V | - |



Unit: mm

Specifications

The specifications below are subject to change without notice. For final specs, please refer to Acer's marketing documentation.

| | |
|---------------------------|---|
| Projection system | DLP™ |
| Computer compatibility | Refer to the "Compatibility Modes" section for more information. |
| Video compatibility | HDTV (720p/1080i/1080p) |
| Displayable colors | 1.07 billion colors |
| Digital zoom | 0.8 – 2 X |
| Weight | Approximate 2.9 kg (6.39 lbs.) |
| Dimensions (W x D x H) | 304.1 x 226.3 x 107.4 mm (12" x 8.9" x 4.3") 304.1 x 226.3 x 119.2 mm (12" x 8.9" x 4.7") (with tilt adjusting wheels) |
| Power supply | Universal AC input 100 - 240 V, input frequency 50/60 Hz |
| Operating temperature | 0°C to 40°C / 32°F to 104°F |
| Standard package contents | <ul style="list-style-type: none"> • AC power cord x 1 • Remote control x 1 • Battery x 2 (for the remote control) • Quick start guide x 1 |
| Accessory (optional) | <ul style="list-style-type: none"> • HDMI cable x 1 • Security card x 1 • Carrying case x 1 • Wireless dongle (UWA5) x 1 • Android TV dongle x 1 |

PL3510ATV/FL251/LU-P251F/PF-L251F/LR560ATV/ML-470ATV/
 PL3510Z/HL6510ATV/HL6510Z/PL3511ATV/PL3512ATV/
 HL6511ATV/HL6515ATV

| | |
|--------------------------------------|--|
| Resolution | Native: 1080p (1920 x 1080) Maximum: UXGA (1600 x 1200), 1080p (1920 x 1080), WUXGA (1920 x 1200) (supports reduce blanking only) |
| Aspect ratio | Auto, 4:3, 16:9, Full, L.Box |
| Projection lens | F = 2.59 ~ 2.87, f = 16.88 ~ 21.88 mm, 1:1.3 Manual Zoom and Manual Focus |
| Projection screen size (diagonal) | 45" – 300" (1.15 m – 7.62 m) |
| Projection distance with clear focus | 1.5 m – 7.6 m (4.9' – 25.1') |
| Throw ratio | 1.15 ~ 1.5 (79" @ 2 m) |
| Horizontal scan rate | 15 – 100 KHz |
| Vertical refresh scan rate | 24 – 120 Hz |
| Keystone correction | +/-30 Degrees (Vertical & Horizontal), Manual |
| Audio | 10W speaker x 1 |
| Power consumption | Standard mode: 250 W @100 VAC ECO mode: 155 W @ 100 VAC Standby mode: < 0.5 W |

XL3510i/FL350/LU-P350F/PF-L350F/LR560i/ML-470i/XL3511i/
 HL6510i/HL6511i/PL3510i/FL351/LU-P351F/PF-L351F/LR561i/ML-
 471i/PL3510i/HL6512i/HL6513i

| | |
|--------------------------------------|--|
| Resolution | Native: 1080p (1920 x 1080) Maximum: UXGA (1600 x 1200), 1080p (1920 x 1080), WUXGA (1920 x 1200) (supports reduce blanking only) |
| Aspect ratio | Auto, 4:3, 16:9, Full, L.Box |
| Projection lens | F = 2.56 ~ 2.68, f = 22 ~ 24.1 mm, 1:1.1 Manual Zoom and Manual Focus |
| Projection screen size (diagonal) | 55" – 300" (1.4 m – 7.62 m) |
| Projection distance with clear focus | 2.0 m – 9.9 m (6.6' – 32.5') |
| Throw ratio | 1.49 ~ 1.64 (61" @ 2 m) |
| Horizontal scan rate | 15 – 100 KHz |
| Vertical refresh scan rate | 24 – 120 Hz |
| Keystone correction | +/-40 Degrees (Vertical), Manual |
| Audio | 10W speaker x 1 |
| Power consumption | Standard mode: 250 W @100 VAC ECO mode: 155 W @ 100 VAC Standby mode: < 0.5 W |

HL6810ATV/EL8610a/HL-4K10a/EL381/HL381/GL810a/VL-710a/
LR810a/ML-710a/PL3810Z/PL3810ATV/HL6810AX/HL6811ATV/
HL6810/EL8610/HL-4K50/LU-P800K/HL380/GL810/VL-710/LR810/
ML-710/PL3810/PL3811/HL6810X/HL6811

| | |
|--------------------------------------|---|
| Resolution | Native: 3840 x 2160 Maximum: 3840 x 2160 |
| Aspect ratio | Auto, 4:3, 16:9, Full, L.Box |
| Projection lens | F = 2.59 ~ 2.87, f = 16.88 ~ 21.88 mm, 1:1.3 Manual Zoom and Manual Focus |
| Projection screen size (diagonal) | 45" – 300" (1.15 m – 7.62 m) |
| Projection distance with clear focus | 1.5 m – 7.6 m (4.9' – 25.1') |
| Throw ratio | 1.15 ~ 1.5 (79" @ 2 m) |
| Horizontal scan rate | 15 – 100 KHz |
| Vertical refresh scan rate | 24 – 120 Hz |
| Keystone correction | +/-30 Degrees (Vertical & Horizontal), Manual |
| Audio | 10W speaker x 1 |
| Power consumption | Standard mode: 250 W @100 VAC ECO mode: 155 W @ 100 VAC Standby mode: < 0.5 W |

| I/O connectors | PL3510ATV/ FL251/LU-P251F/ PF-L251F/ LR560ATV/ML- 470ATV/PL3510Z/ HL6510ATV/ HL6510Z/ PL3511ATV/ PL3512ATV/ HL6511ATV/ HL6515ATV | XL3510i/FL350/ LU-P350F/PF- L350F/LR560i/ML- 470i/XL3511i/ HL6510i/HL6511i/ PL3510i/FL351/ LU-P351F/PF- L351F/LR561i/ML- 471i/PL3510i/ HL6512i/HL6513i | HL6810ATV/ EL8610a/HL- 4K10a/EL381/ HL381/GL810a/ VL-710a/ LR810a/ML- 710a/PL3810Z/ PL3810ATV/ HL6810AX/ HL6811ATV | HL6810/ EL8610/HL- 4K50/LU- P800K/HL380/ GL810/VL-710/ LR810/ML-710/ PL3810/ PL3811/ HL6810X/ HL6811 |
|--------------------------|--|---|---|---|
| Power socket | V | V | V | V |
| AUDIO OUT | V | V | V | V |
| RS232 | V | V | V | V |
| DC 5V OUT (SERVICE) | V | V | V | V |
| HDMI 1 | V | V | V | V |
| HDMI 2 | - | V | - | - |
| HDMI 2 (AUDIO RETURN) | V | - | V | V |
| S/PDIF | V | - | - | - |
| WIRELESS DONGLE | - | V | - | - |
| ATV DONGLE | V | - | V | - |

* Design and specifications are subject to change without notice.

Compatibility Modes

1 HDMI - PC Signal

| Mode | Resolution | V.Frequency [Hz] | H.Frequency [KHz] |
|------------|-----------------|------------------|-------------------|
| VGA_60 | 640 x 480 | 59.94 | 31.469 |
| VGA_72 | | 72.809 | 37.861 |
| VGA_75 | | 75 | 37.5 |
| VGA_85 | | 85.008 | 43.269 |
| VGA_120 | | 119.518 | 61.91 |
| SVGA_56 | 800 x 600 | 56.25 | 35.156 |
| SVGA_60 | | 60.317 | 37.879 |
| SVGA_72 | | 72.188 | 48.077 |
| SVGA_75 | | 75 | 46.875 |
| SVGA_85 | | 85.061 | 53.674 |
| SVGA_120 | | 119.854 | 77.425 |
| XGA_60 | 1024 x 768 | 60.004 | 48.363 |
| XGA_70 | | 70.069 | 56.476 |
| XGA_75 | | 75.029 | 60.023 |
| XGA_120 | | 119.804 | 98.958 |
| SXGA_75 | 1152 x 864 | 75 | 67.5 |
| SXGA_85 | | 84.99 | 77.094 |
| SXGA_60 | 1280 x 1024 | 60.02 | 63.981 |
| SXGA_72 | | 72 | 76.97 |
| SXGA_75 | | 75.025 | 79.976 |
| SXGA_85 | | 85.024 | 91.146 |
| QuadVGA_75 | 1280 x 960 | 75 | 75 |
| SXGA+_60 | 1400 x 1050 | 59.978 | 65.317 |
| UXGA_60 | 1600 x 1200 | 60 | 75 |
| Mac G4 | 640 x 480@60Hz | 59.94 | 31.469 |
| MAC13 | 640 x 480@67Hz | 66.667 | 35 |
| Mac G4 | 800 x 600@60Hz | 60.317 | 37.879 |
| Mac G4 | 1024 x 768@60Hz | 60.004 | 48.363 |
| MAC19 | 1024 x 768@75Hz | 75.02 | 60.241 |
| MAC21 | 1152 x 870@75Hz | 75.061 | 68.681 |
| WXGA_60 | 1280 x 768 | 59.87 | 47.776 |
| WXGA_75 | | 74.893 | 60.289 |
| WXGA_85 | | 84.837 | 68.633 |
| WXGA_60 | 1280 x 720 | 60 | 45 |

| | | | |
|-----------------|-------------|---------|---------|
| WXGA_60 | 1280 x 800 | 59.81 | 49.702 |
| WXGA_120-RB | 1280 x 800 | 119.909 | 101.563 |
| WXGA+_60 | 1440 x 900 | 59.887 | 55.935 |
| 1680 x 1050_60 | 1680 x 1050 | 59.954 | 65.29 |
| acer_16:9 | 1366 x 768 | 59.79 | 47.712 |
| 1920 x 1080_RB | 1920 x1080 | 60 | 66.587 |
| 1920 x 1080_EIA | 1920 x1080 | 60 | 67.5 |
| 1920 x 1080_120 | 1920 x1080 | 119.982 | 137.26 |
| 1920 x 1080_240 | 1920 x1080 | 239.76 | 291.309 |
| acer_timing | 1024 x 600 | 60 | 37.5 |
| 1920 x 1200-RB | 1920 x 1200 | 59.95 | 74.038 |
| 3840 x 2160_30 | 3840 x 2160 | 30 | 67.5 |
| 3840 x 2160_60 | 3840 x 2160 | 60 | 135 |

2 HDMI - Video Signal

| Mode | Resolution | V.Frequency [Hz] | H.Frequency [KHz] |
|----------|---------------------------|------------------|-------------------|
| 480i | 720 x 480 (1440 x 480) | 60 | 15.73 |
| 480p | 720 x 480 | 60 | 31.47 |
| 576i | 720 x 576 (1440 x 576) | 50 | 15.63 |
| 576p | 720 x 576 | 50 | 31.25 |
| 720p | 1280 x 720 | 60 | 45.00 |
| 720p | 1280 x 720 | 50 | 37.50 |
| 1080i | 1920 x 1080 | 60 | 33.75 |
| 1080i | 1920 x 1080 | 50 | 28.13 |
| 1080p | 1920 x 1080 | 60 | 67.50 |
| 1080p | 1920 x 1080 | 50 | 56.26 |
| 1080p | 1920 x 1080 | 24 | 27.00 |
| 1080p | 1920 x 1080 | 23.98 | 26.97 |
| 1080p | 1920 x 1080 | 30 | 33.75 |
| 2160/24P | 3840 x 2160 | 24 | 54 |
| 2160/25P | 3840 x 2160 | 25 | 56.25 |
| 2160/30P | 3840 x 2160 | 30 | 67.5 |
| 2160/50P | 3840 x 2160 | 50 | 112.5 |
| 2160/60P | 3840 x 2160 | 60 | 135 |

Regulations and safety notices

FCC notice

This device has been tested and found to comply with the limits for a Class B digital device pursuant to Part 15 of the FCC rules. These limits are designed to provide reasonable protection against harmful interference in a residential installation. This device generates, uses, and can radiate radio frequency energy and, if not installed and used in accordance with the instructions, may cause harmful interference to radio communications.

However, there is no guarantee that interference will not occur in a particular installation. If this device does cause harmful interference to radio or television reception, which can be determined by turning the device off and on, the user is encouraged to try to correct the interference by one or more of the following measures:

- Reorient or relocate the receiving antenna.
- Increase the separation between the device and receiver.
- Connect the device into an outlet on a circuit different from that to which the receiver is connected.
- Consult the dealer or an experienced radio/television technician for help.

Notice: Shielded cables

All connections to other computing devices must be made using shielded cables to maintain compliance with FCC regulations.

Notice: Peripheral devices

Only peripherals (input/output devices, terminals, printers, etc.) certified to comply with the Class B limits may be attached to this equipment. Operation with non-certified peripherals is likely to result in interference to radio and TV reception.

Caution

Changes or modifications not expressly approved by the manufacturer could void the user's authority, which is granted by the Federal Communications Commission, to operate this device.

Operation conditions

This device complies with Part 15 of the FCC Rules. Operation is subject to the following two conditions: (1) this device may not cause harmful interference, and (2) this device must accept any interference received, including interference that may cause undesired operation.

Notice: Canadian users

This Class B digital apparatus complies with Canadian ICES-003.

Remarque à l'intention des utilisateurs canadiens

Cet appareil numérique de la classe B est conforme à la norme NMB-003 du Canada.

Compliant with Russian/Ukraine/Belarus/Morocco regulatory certification



Radio device regulatory notice



.....
Note: The regulatory information below is for models with wireless LAN and/or Bluetooth only.

General

This product complies with the radio frequency and safety standards of any country or region in which it has been approved for wireless use. Depending on configurations, this product may or may not contain wireless radio devices (such as wireless LAN and/or Bluetooth modules).

Canada — Low-power license-exempt radio communication devices (RSS-247)

- a Common information
 Operation is subject to the following two conditions:
 1. This device may not cause interference, and
 2. This device must accept any interference, including interference that may cause undesired operation of the device.
- b Operation in 2.4 GHz band
 To prevent radio interference to the licensed service, this device is intended to be operated indoors and installation outdoors is subject to licensing.

List of applicable countries

This device must be used in strict accordance with the regulations and constraints in the country of use. For further information, please contact a local office in the country of use. Please see <http://ec.europa.eu/enterprise/rtte/implement.htm> for the latest country list.

Recycling Information for the United States of America

Acer encourages information technology (IT) equipment owners to responsibly recycle their equipment when it is no longer needed. Acer offers programs and services to assist equipment owners with this process.

For more information on recycling IT equipment, please go to:
<https://www.acer.com/ac/en/US/content/recycling>