

**SAMSUNG**

# USER MANUAL

---



**The Premiere**

**Laser Projector**

**LSP7T / LSP9T**

---



Thank you for purchasing this Samsung product.

To receive more complete service, please register your product at [www.samsung.com](http://www.samsung.com)

Model \_\_\_\_\_ Serial No. \_\_\_\_\_

# Before Reading This User Manual

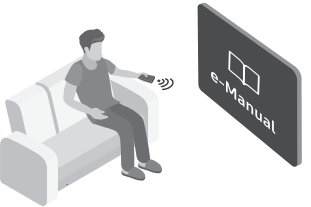



This Projector comes with this user manual and an embedded e-Manual.  
Before reading this user manual, review the following:

	<b>User Manual</b>	Read this provided user manual to see information about product safety, installation, accessories, initial configuration, and product specifications.
	<b>e-Manual</b>	For more information about this Projector, read the e-Manual embedded in the product. <ul style="list-style-type: none"> <li>To open the e-Manual, <ul style="list-style-type: none"> <li> &gt;  <b>Settings</b> &gt; <b>Support</b> &gt; <b>Open e-Manual</b></li> </ul> </li> </ul>



On the website ([www.samsung.com](http://www.samsung.com)), you can download the manuals and see its contents on your PC or mobile device.

## Learning the e-Manual's assistance functions

- Some menu screens cannot be accessed from the e-Manual.

	<b>Search</b>	Select an item from the search results to load the corresponding page.
	<b>Index</b>	Select a keyword to navigate to the relevant page. <ul style="list-style-type: none"> <li>The menus may not appear depending on the geographical area.</li> </ul>
	<b>Site Map</b>	It displays the lists for each item in e-Manual.
	<b>Recently Viewed Topics</b>	Select a topic from the list of recently viewed topics.

## Learning the functions of the buttons that appear on e-Manual topic pages

	<b>Try Now</b>	Allows you to access the corresponding menu item and try out the feature right away.
	<b>Link</b>	Access an underlined topic referred to on an e-Manual page immediately.

# Features of your Projector

## Home Screen

In Home Screen, you can easily run the apps that have been used previously or frequently. The apps can also be moved or deleted in the screen.

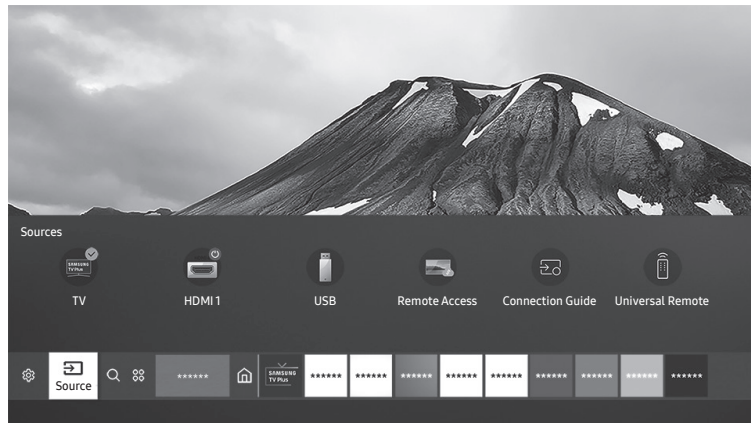

- The image on your Projector may differ from the image above depending on the model and geographical area.





## e-Manual

Get help from a detailed, on-screen user's manual built into your Projector.

# Warning! Important Safety Instructions

Please read the Safety Instructions before using your Projector.

Refer to the table below for an explanation of symbols which may be on your Samsung product.

CAUTION	
<b>RISK OF ELECTRIC SHOCK. DO NOT OPEN.</b>	
CAUTION: TO REDUCE THE RISK OF ELECTRIC SHOCK, DO NOT REMOVE COVER (OR BACK). THERE ARE NO USER SERVICEABLE PARTS INSIDE. REFER ALL SERVICING TO QUALIFIED PERSONNEL.	
	This symbol indicates that high voltage is present inside. It is dangerous to make any kind of contact with any internal part of this product.
	This symbol indicates that this product has included important literature concerning operation and maintenance.
	AC voltage: Rated voltage marked with this symbol is AC voltage.
	DC voltage: Rated voltage marked with this symbol is DC voltage.
	Caution. Consult instructions for use: This symbol instructs the user to consult the user manual for further safety related information.

## Installation

- The slots and openings in the cabinet and in the back or bottom are provided for necessary ventilation. To ensure reliable operation of this apparatus and to protect it from overheating, these slots and openings must never be blocked or covered.
  - Do not place this apparatus in a confined space, such as a bookcase or built-in cabinet, unless proper ventilation is provided.
  - Do not place this apparatus near or over a radiator or heat register, or where it is exposed to direct sunlight.
  - Do not place vessels (vases etc.) containing water on this apparatus, as this can result in a fire or electric shock.
- Do not expose this apparatus to rain or moisture.
- Be sure to contact an authorised Samsung service centre for information if you intend to install your Projector in a location with heavy dust, high or low temperatures, high humidity, chemical substances, or where it will operate 24 hours a day such as in an airport, a train station, etc. Failure to do so may lead to serious damage to your Projector.

- Do not expose this apparatus to dripping or splashing.
- Do not dispose of batteries in a fire.
- Batteries (battery pack or batteries installed) shall not be exposed to excessive heat such as sunshine, fire or the like.
- **CAUTION:** There is danger of an explosion if you replace the batteries used in the remote with the wrong type of battery. Replace only with the same or equivalent type.
- **WARNING - TO PREVENT THE SPREAD OF FIRE, KEEP CANDLES AND OTHER ITEMS WITH OPEN FLAMES AWAY FROM THIS PRODUCT AT ALL TIMES.**
- Use care when touching the Projector after it has been on for some time. Some parts can be warm to the touch.



## Operation

- This apparatus uses batteries. In your community, there might be environmental regulations that require you to dispose of these batteries properly. Please contact your local authorities for disposal or recycling information.
- Do not drop or strike the product. If the product is damaged, disconnect the power cord and contact a Samsung service centre.
- When you need to turn off the Projector completely, wait until the fan stops completely so that the Projector can cool down completely.

## Power

- Do not overload wall outlets, extension cords, or adaptors beyond their capacity, since this can result in fire or electric shock.
- Power-supply cords should be placed so that they are not likely to be walked on or pinched by items placed upon or against them. Pay particular attention to cords at the plug end, at wall outlets, and at the point where they exit from the appliance.
- To protect this apparatus from a lightning storm, or when left unattended and unused for long periods of time, unplug it from the wall outlet and disconnect the antenna or cable system. This will prevent damage to the set due to lightning and power line surges.
- Before plugging in the AC power cord of the Projector, make sure that the operational voltage of the Projector matches the voltage of your local electrical power supply. Refer to the power specifications section of the manual and/or the power supply label on the product for voltage and amperage information.
- Never insert anything metallic into the open parts of this apparatus. This may cause electric shock.
- To avoid electric shock, never touch the inside of this apparatus. Only a qualified technician should open this apparatus.

- Be sure to plug in the power cord until it is firmly seated. When unplugging the power cord from a wall outlet, always pull on the power cord's plug. Never unplug it by pulling on the power cord. Do not touch the power cord with wet hands.
- If this apparatus does not operate normally - in particular, if there are any unusual sounds or smells coming from it - unplug it immediately and contact an authorised dealer or Samsung service centre.
- Be sure to pull the power plug out of the outlet if the Projector is to remain unused or if you are going to leave the house for an extended period of time (especially when children, elderly, or disabled people will be left alone in the house).
  - Accumulated dust can cause an electric shock, an electric leakage, or a fire by causing the power cord to generate sparks and heat or by causing the insulation to deteriorate.
- Use only a properly grounded plug and wall outlet.
  - An improper ground may cause electric shock or equipment damage. (Class I Equipment only.)
- To turn off this apparatus completely, disconnect it from the wall outlet. To ensure you can unplug this apparatus quickly if necessary, make sure that the wall outlet and power plug are readily accessible.

## Cleaning

- To clean this apparatus, unplug the power cord from the wall outlet and wipe the product with a soft, dry cloth. Do not use any chemicals such as wax, benzene, alcohol, thinners, insecticide, aerial fresheners, lubricants, or detergents. These chemicals can damage the appearance of the Projector or erase the printing on the product.
- Do not spray water or any liquid directly onto the Projector. Any liquid that goes into the product may cause a failure, fire, or electric shock.

## Laser

- Do not block the light coming out of the projector lens when in operation. The light will heat the object and may melt, cause burns or start a fire.
- Do not look directly at the light from the Projector lens or project the light into any person's eyes.



- **WARNING: MOUNT ABOVE THE HEADS OF CHILDREN.** Additional warning against eye exposure for close exposures less than 1 m.

- As with any bright source, do not stare into the direct beam, RG2 IEC 62471-5:2015.
- This projector is class 1 laser product of IEC 60825-1:2014 and risk group 2 with the requirements of IEC 62471-5:2015
- Additional instructions to supervise children, no staring, and not use optical aids
  - Notice is given to supervise children and to never allow them to stare into the projector beam at any distance from the projector.
  - Notice is given to use caution when using the remote control for starting the projector while in front of the projection lens.
  - Notice is given to the user to avoid the use of optical aids such as binoculars or telescopes inside the beam.
- Do not open or disassemble the projector as this may cause damage by the exposure of laser Radiation.

## Antenna

- Bend down the part where the outdoor antenna line goes into the inside so that rainwater cannot flow into it.
- If you are using an outdoor antenna, please install it away from electrical wires to make sure it does not touch any nearby wires even when it falls down due to heavy wind.

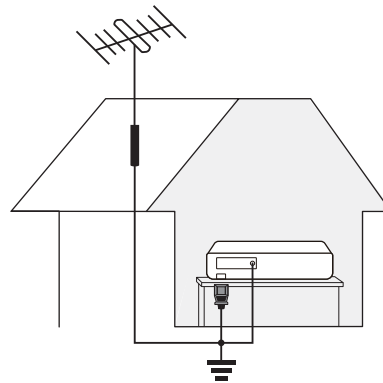

# Contents

Before Reading This User Manual	2
Features of your Projector	3
Warning! Important Safety Instructions	4
<b>01 What's in the Box?</b>	
<b>02 Product Overview</b>	
About the Projector	11
<b>03 Installing the Projector</b>	
Image size and projection distance	14
Using the Power button	15
Mounting the Projector on a wall	16
<b>04 The Remote Control</b>	
About the Buttons on the Remote Control	17
<b>05 The Samsung Smart Remote</b>	
About the Buttons on the Samsung Smart Remote	19
Installing batteries into the Samsung Smart Remote	20
About the Samsung Smart Remote	20
Controlling External Devices with a Samsung Remote Control - Using the Universal Remote	22
<b>06 Connections</b>	
Connecting devices to your Projector	23
Connecting to the Internet	24



<b>07</b>	<b>Selecting Connected Devices</b>	
	Changing the input signal	25
	Editing external devices	25
	Using additional functions	25
<b>08</b>	<b>Troubleshooting and Maintenance</b>	
	Troubleshooting	26
<b>09</b>	<b>Specifications and Other Information</b>	
	Specifications	28
	Environmental Considerations	28
	Decreasing power consumption	29
	Licences	29
	Warranty Card	31
	WARRANTY CONDITIONS	31

# 01 What's in the Box?

Make sure the following items are included with your Projector. If any items are missing, contact your dealer.



Samsung Smart Remote & Batteries (AA x 2)



Remote Control & Batteries (AAA x 2)

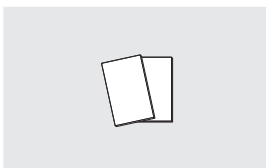

User Manual

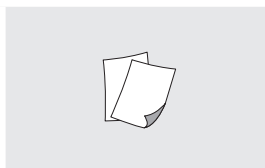

Regulatory Guide

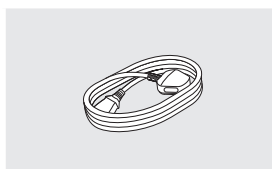

Power Cable

- The items' colours and shapes may vary depending on the models.
- Cables not included can be purchased separately.
- When connecting an HDMI or USB cable, or connecting a USB flash drive to the HDMI or USB port, use a product that has a width of 18 mm or less and a height of 10 mm or less. If the USB cable or USB flash drive does not fit the USB ports of the projector, use an extension cable that supports USB 2.0.
- Use a certified cable with the HDMI logo attached.
- If you do not use a certified HDMI cable, the screen may not display or a connection error may occur.  
(Recommended HDMI cable types)
  - Ultra High-Speed HDMI Cable (3 m or less)

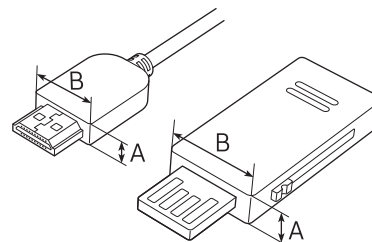

$A \leq 10 \text{ mm} / B \leq 18 \text{ mm}$

An administration fee may be charged in the following situations:

- (a) An engineer is called out at your request, but it is found that the product has no defect (i.e., where the user manual has not been read).
- (b) You bring the unit to the Samsung service centre, but it is found that the product has no defect (i.e., where the user manual has not been read).

You will be informed of the administration fee amount before a technician visits.

# 02 Product Overview

## About the Projector

<Front>

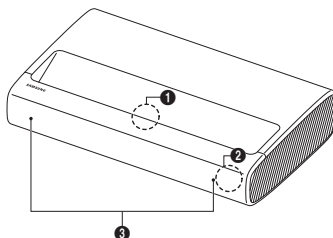

SP-LSP7TFA

SP-LSP9TFA

<Rear>

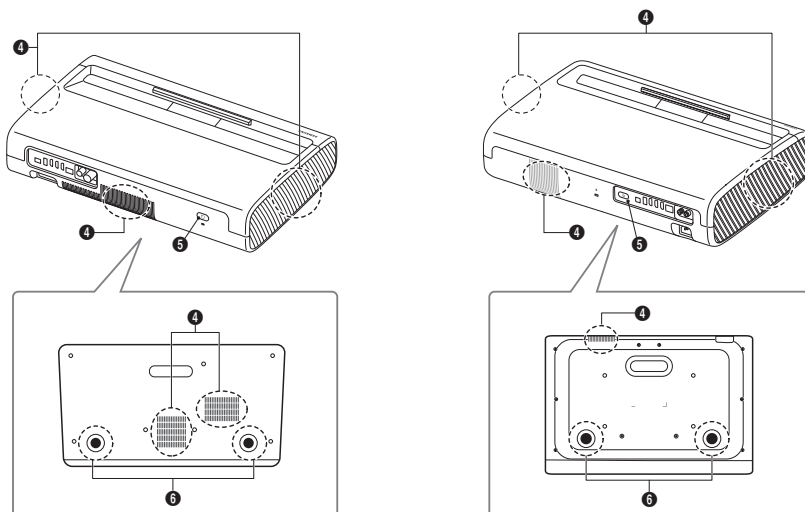

- |           |  |                        |
|-----------|--|------------------------|
| ❶ Lens    | ❷ Remote control sensor / LED Indicators | ❹ Ventilation          |
| ❸ Speaker | ❺ Power button                           | ❻ Tilt-Adjustment Foot |

- The product colour and shape may vary depending on the model.
- Do not block projector intake and exhaust vents.
- When operating the projector in an enclosed space, allow at least 50 cm clearance around the intake and exhaust vents.

## 03 Installing the Projector

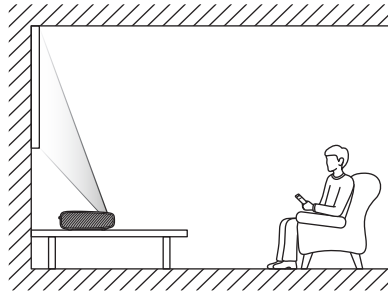

Install the projector horizontally on a flat surface to prevent it from being tilted. When the screen and the projector are not aligned horizontally and vertically, or the screen is curved, the display may get distorted.

1. Place the projector at an appropriate distance from the screen to be projected, connect with the power cable, and then turn it on.
  - When you turn on your Projector for the first time, it immediately starts the Initial Setup. Follow the instructions displayed on the screen and configure the Projector's basic settings to suit your viewing environment.
    - You can turn on the Projector with the power button at the rear of the Projector, and then use the **Control menu**. The **Control menu** appears when the power button is pressed while the Projector is On.
    - When the screen looks skewed or blurred, adjust the display settings by following the next instruction.

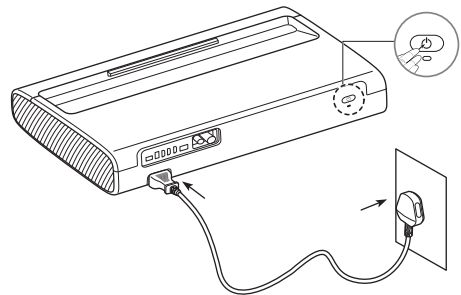

- The product colour and shape may vary depending on the model.

2. Adjust the angle by moving the projector left or right or adjust the angle adjusting tilt-adjustment foot at the bottom to make the screen to be rectangular.

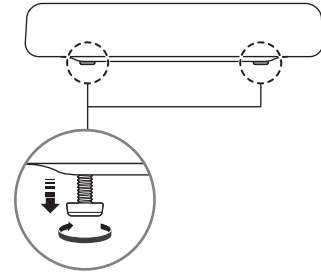
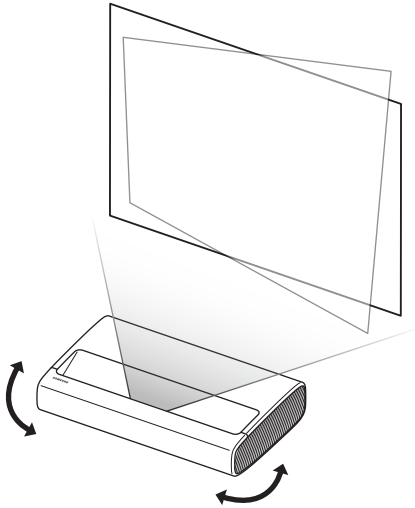

3. Move the projector forward or backward to adjust the projection distance for a desired screen size.
- When the projected screen is unclear, adjust in **Settings > General > Projector Settings > Focus**.
  - When the projected screen is not a right angle, adjust in **Projector Settings > Screen Adjustment**.  
In this case, the screen resolution may decrease.
  - For information about the screen sizes for each projection distance, refer to the following table.

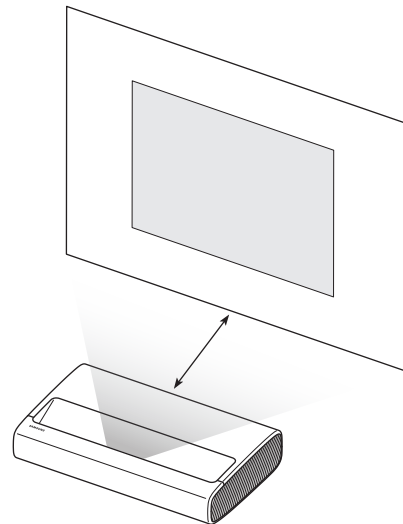

## Image size and projection distance

- The screen sizes for each projection distance may differ depending on the installation environment.

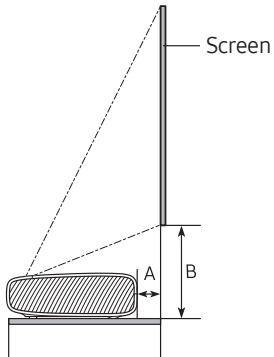

### SP-LSP7TFA

C (inches)	X (mm)	Y (mm)	A (mm)	B (mm)
90	1992	1121	247	349
95	2103	1183	275	364
100	2214	1245	303	379
105	2324	1308	331	394
110	2435	1370	359	409
115	2546	1432	387	424
120	2657	1494	415	439

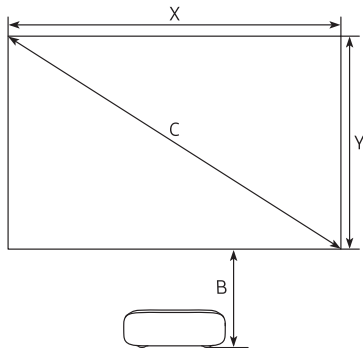

### SP-LSP9TFA

C (inches)	X (mm)	Y (mm)	A (mm)	B (mm)
100	2214	1245	113	351
105	2324	1308	134	363
110	2435	1370	154	376
115	2546	1432	175	388
120	2657	1494	196	401
125	2767	1557	217	413
130	2878	1619	238	426

## Using the Power button

You can turn on the Projector with the power button at the rear of the Projector, and then use the **Control menu**. The **Control menu** appears when the power button is pressed while the Projector is On. For more information about its usage, refer to the figure below.

- Manipulate buttons on the side of the product so that the projected screen is not covered.
- Be careful not to directly get the light emitted from the projector lens.

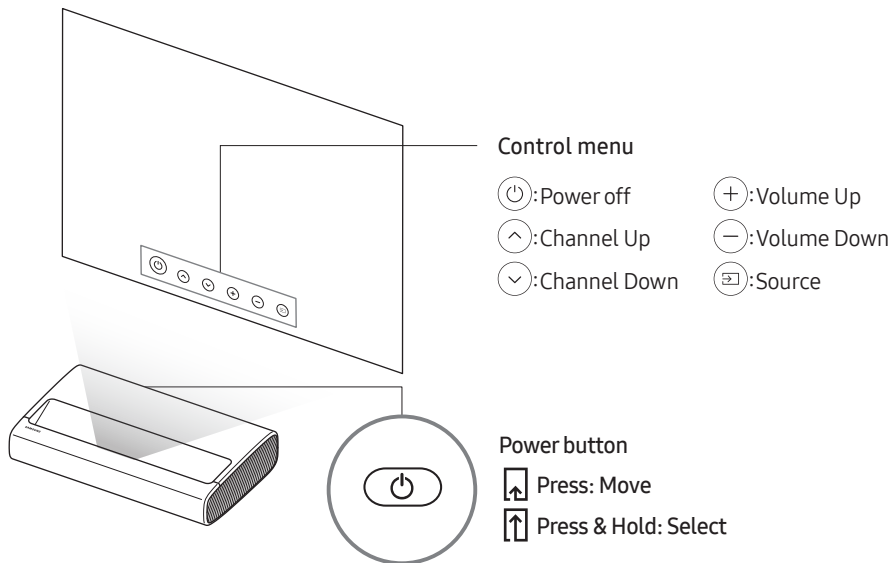

- The product colour and shape may vary depending on the model.

## Mounting the Projector on a wall



In order to install the projector on a wall, be sure to consult with a professional service agency. Otherwise, the projector may slip or fall off, resulting in personal injury or damage to the product.

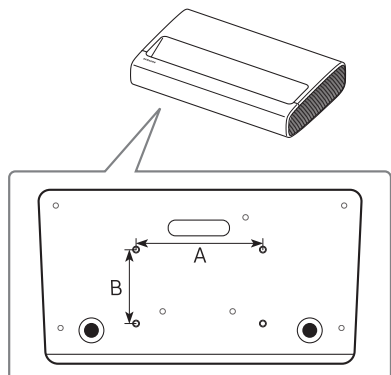

When installing a wall mount kit, we recommend you fasten all four screws.

Screw hole specs (A * B) in millimetres	Screw Depth (mm)	Standard Screw	Quantity
235 x 135	7-9	M6	4

- The product colour and shape may vary depending on the model.



**Do not install your wall mount kit while your Projector is turned on. This may result in personal injury from electric shock.**

- Do not use screws that are longer than the standard dimension or do not comply with the standard screw specifications. Screws that are too long may cause damage to the inside of the Projector set.
- For wall mounts that do not comply with the standard screw specifications, the length of the screws may differ depending on the wall mount specifications.
- Do not fasten the screws too firmly. This may damage the product or cause the product to fall, leading to personal injury. Samsung is not liable for these kinds of accidents.
- Samsung is not liable for product damage or personal injury when a non-specified wall mount is used or when the consumer fails to follow the product installation instructions.
- Always have two people mount the Projector onto a wall.

### Other Cautions

- The actual appearance of the Projector may differ from the images in this manual, depending on the model.
- Be careful when you touch the Projector. Some parts can be somewhat hot.



# 04 The Remote Control

## About the Buttons on the Remote Control

- This remote control has Braille points on the Power, Channel, Volume, and Select buttons and can be used by visually impaired persons.
- The images, buttons, and functions of the remote control may differ depending on the model.
- If you use the remote control that comes with your Projector to control another TV, some functions may not operate normally.

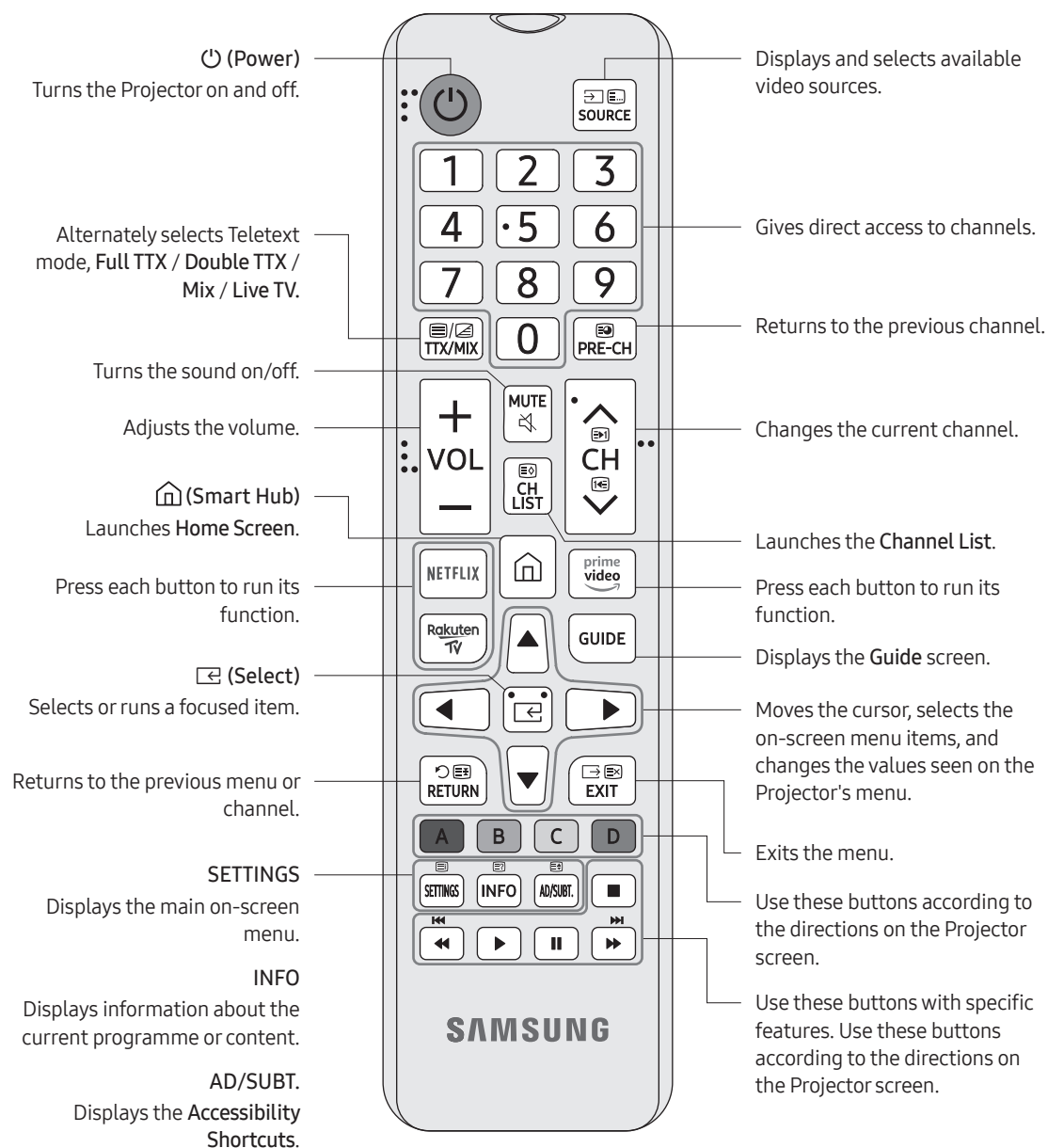

## Installing batteries into the remote control (Battery size: AAA)

Match the polarities of the batteries to the symbols on the battery compartment.

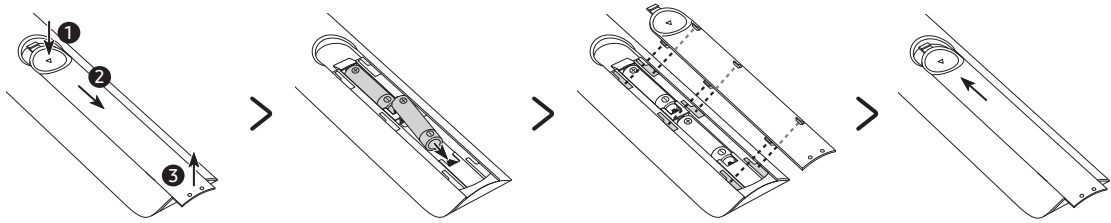

- The colour and shape of the remote may vary depending on the model.
  - Use the remote control within 7 m of the Projector.
  - Bright lights may affect the performance of the remote control. Avoid using the remote control near special fluorescent lights or neon signs.
  - Alkaline batteries are recommended for longer battery life.
1. Gently pull on the battery cover's notch and then remove the cover completely once it comes loose.
  2. Insert 2 AAA alkaline batteries, making sure to align the positive and negative polarities correctly.
  3. Place the battery cover on the remote control and insert the cover into the remote control.
  4. Slide the battery cover in the order shown above so that the cover is completely attached to the remote control.

# 05 The Samsung Smart Remote

## About the Buttons on the Samsung Smart Remote

- The images, buttons, and functions of the Samsung Smart Remote may differ depending on the model.
- The Universal Remote function operates normally only when you use the Samsung Smart Remote that comes with the Projector.

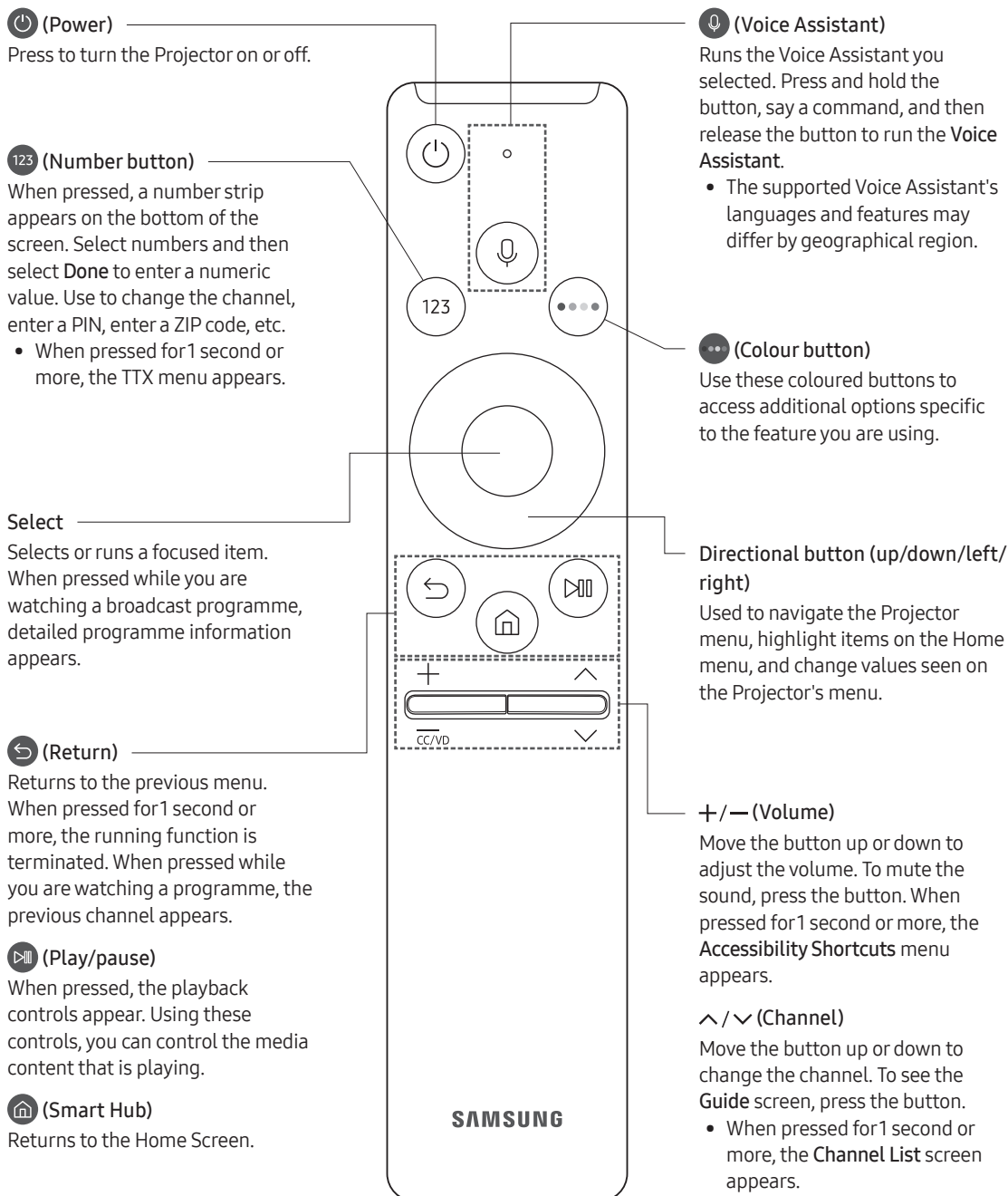

## Installing batteries into the Samsung Smart Remote

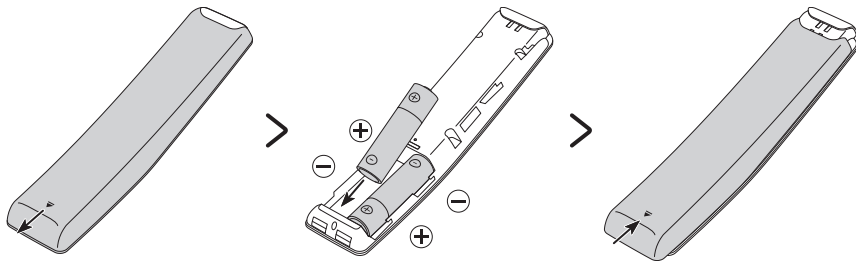

To install the batteries, push the rear cover open in the direction of the arrow at the bottom of the illustration, and then insert the batteries as shown in the figure. Make sure that the positive and negative ends are facing in the correct direction. Close the rear cover as shown.



- Alkaline batteries are recommended for longer battery life.

## About the Samsung Smart Remote

When you start the Projector for the first time by pressing the **⏻** (Power) button on the Samsung Smart Remote, the Projector automatically pairs with the Samsung Smart Remote. Once the Projector and Samsung Smart Remote have paired, you can use the Samsung Smart Remote to operate the Projector.

We recommend using Samsung Smart Remote at a distance of less than 6 m. A usable distance may differ depending on the wireless environmental conditions.



## Pairing the Projector to the Samsung Smart Remote

When you turn on the Projector for the first time, the Samsung Smart Remote pairs to the Projector automatically. If the Samsung Smart Remote does not pair to the Projector automatically, point it at the remote control sensor of the Projector, and then press and hold the  and  buttons simultaneously for 3 seconds or more.

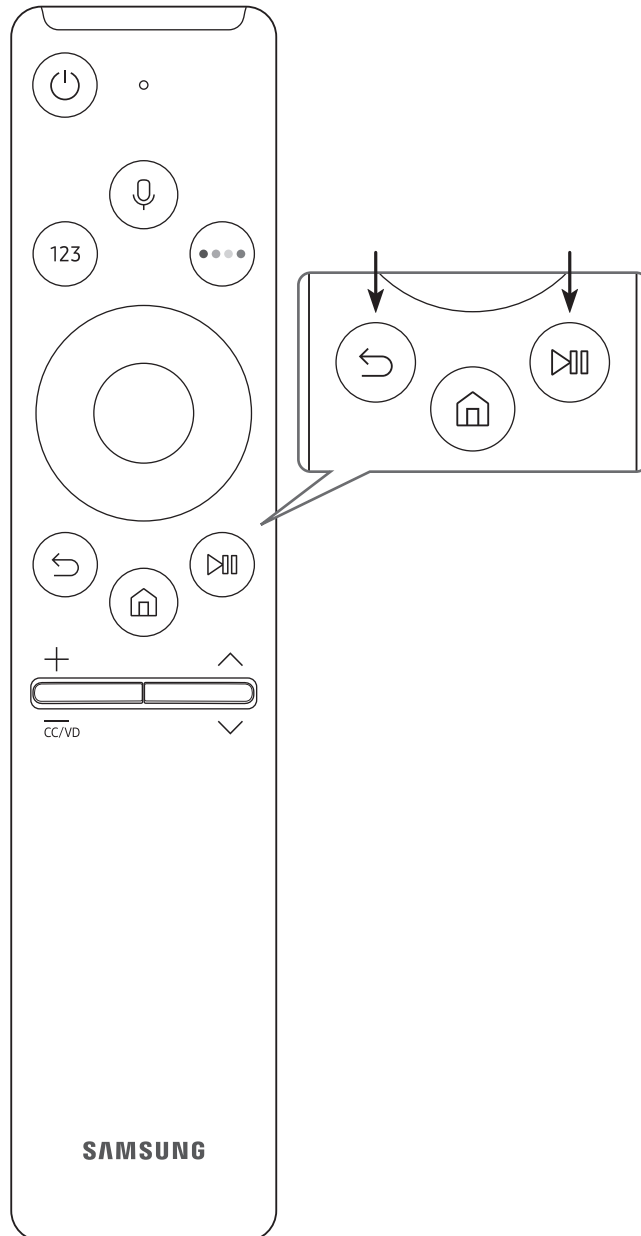
- The Samsung Smart Remote can only be paired to one Projector at a time.



## Controlling External Devices with a Samsung Remote Control - Using the Universal Remote

 >  Source > Universal Remote

You can control external devices connected to the Projector using a Samsung remote control. To control external devices, register them by following the instructions on the screen.

- This function may not be supported depending on the model.
- You can also use the **Anynet+ (HDMI-CEC)** function to operate external Samsung devices with your Projector's remote control without any additional setup.
- Certain external devices connected to the Projector may not support the universal remote feature.
- Do not place any obstacles in front of an external device and Projector's logo. It may cause signals from the remote control to be transmitted improperly.
- The Projector memorises both the external device and its connection port (HDMI 1, HDMI 2, etc.).
- If you have difficulty controlling external devices with the Universal Remote, try adjusting the positions of the external devices.
- This function may not operate properly depending on the Projector installation environment and the features of external devices.





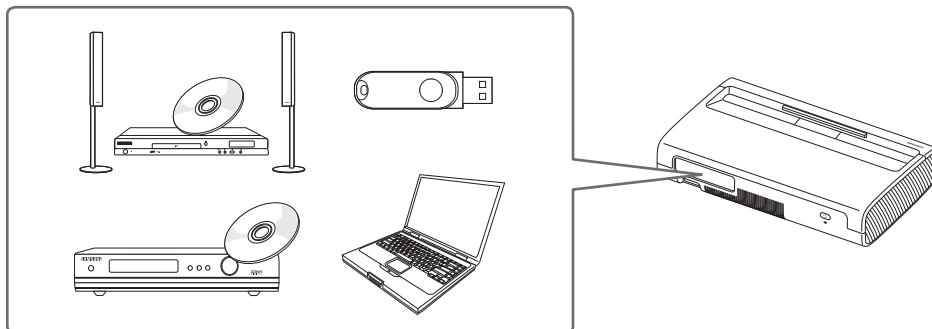

# 06 Connections

## Connecting devices to your Projector

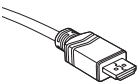

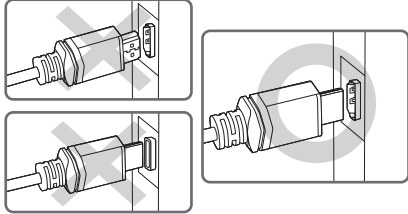
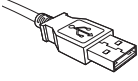
You can connect various external devices using the connectors located at the back of the product. Check the connectors and then refer to the Quick Guide for more instructions on supported external devices.

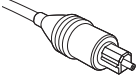
For more information about connections, see the e-Manual chapter "Guide > Connections". Make sure you have the correct cable before plugging it in. Illustrations of common plugs and ports are shown below.

	Cable Plugs	Ports	
HDMI			 <p><b>Warning</b> Do not plug cables in upside down. Be sure to check the orientation of the plug before plugging it in.</p>
USB			
Optical			

## Connecting to the Internet

Connecting the Projector to a network gives you access to online services such as the Smart Hub, as well as software updates.

- For more information about Smart Hub, see the e-Manual chapter, "**Guide > Smart Features > Using Smart Hub**".
- The shape of the rear panel differs among the models.

### Network Connection - Wireless

Connect the Projector to the Internet using a wireless access point or modem.

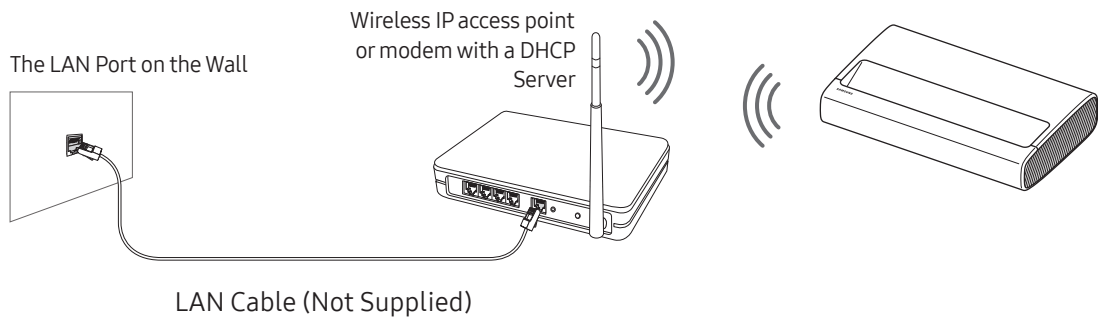

### Network Connection - Wired

There are three main ways to connect your Projector to your network using cable, depending on your network setup. They are illustrated starting below:

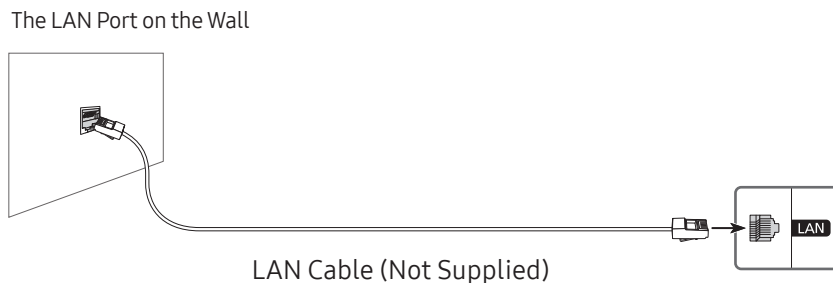



- The Projector will not be able to connect to the Internet if your network speed is below 10 Mbps.
- To connect a LAN cable, use a CAT 7 (\*STP type) cable for the connection. (100/10 Mbps)  
\* Shielded Twisted Pair



# 07 Selecting Connected Devices

## Changing the input signal

 >  Source

When you select a connected external device on the **Source** screen, the output of the selected device is displayed on the Projector's screen.

- For more information about selecting connected devices, see the e-Manual chapter "**Guide** > **Connections** > **Switching between external devices connected to the Projector**".

## Editing external devices

You can change the port name for a connected external device or add it to Home Screen.

1. Move the focus to a connected external device.
2. Press the Up directional button. The following functions become available.
  - Available functions may differ depending on the port type.
  - **Universal Remote:** You can control external devices connected to the Projector using a Samsung remote control. To control external devices, register them by following the instructions on the screen.
  - **Edit:** You can rename the input ports and change the device icons.
  - **Information:** You can view the detailed information about the external devices connected to the Projector.
  - **Add to Home:** You can add the port of an external device to the Home Screen for quick switching.

## Using additional functions

You can use the following features on the **Source** screen.

- **Remote Access:** Use the Projector to access your PC via remote PC or Screen Sharing (Wireless).
- **Connection Guide:** The guide to device connections
- **Universal Remote:** Lets you register external devices to your Samsung remote control and control them using the Remote.

# 08 Troubleshooting and Maintenance

## Troubleshooting

If the Projector seems to have a problem, first review this list of possible problems and solutions. Alternatively, review the Troubleshooting Section in the e-Manual. If none of the troubleshooting tips apply, please visit "www.samsung.com" and click Support or contact the Samsung service centre listed on the back cover of this manual.

- To keep your Projector in optimum condition, upgrade to the latest software. Use the **Update Now** or **Auto update** functions on the Projector's menu (🏠 > ⚙️ **Settings** > **Support** > **Software Update** > **Update Now** or **Auto update**).

### The Projector won't turn on.

- Make sure that the AC power cable is securely plugged in to the Projector and the wall outlet.
- Make sure that the wall outlet is working and the Remote control sensor at the front right of the Projector is lit and glowing a solid red.
- Try pressing the **Power** button at the rear of the Projector to make sure that the problem is not with the remote control. If the Projector turns on, refer to "The remote control does not work".

## There is no picture/video/sound, or a distorted picture/video/sound from an external device, or “Weak or No Signal” is displayed on the Projector, or you cannot find a channel.

- Make sure the connection to the device is correct and that all cables are fully inserted.
- Remove and reconnect all cables connected to the Projector and the external devices. Try new cables if possible.
- Confirm that the correct input source has been selected (🏠 > 📺 Source).
- Perform a Projector self diagnosis to determine if the problem is caused by the Projector or the device (🏠 > ⚙️ Settings > Support > Device Care > Self Diagnosis > Picture Test or Sound Test).
- If the test results are normal, reboot the connected devices by unplugging each device's power cable and then plugging it in again. If the issue persists, refer to the connection guide in the user manual of the connected device.
- If you are not using a cable box or satellite box, and your Projector is receiving TV signals from an antenna or a cable wall connector, run **Auto Tuning** to search for channels (🏠 > ⚙️ Settings > Broadcasting > (Auto Tuning Settings) > Auto Tuning).
  - The **Auto Tuning Settings** may not appear depending on the model or geographical area.
  - If you are using a cable box or satellite box, please refer to the cable box or satellite box manual.

## The remote control does not work.

- Check if the power indicator at the front right of the Projector blinks when you press the remote's Power button. If it does not, replace the remote control's batteries.
- Make sure that the batteries are installed with their poles (+/–) in the correct direction.
- Try pointing the remote directly at the Projector from 1.5-1.8 m away.
- If your Projector came with a Samsung Smart Remote (Bluetooth Remote), make sure to pair the remote to the Projector.

# 09 Specifications and Other Information

## Specifications

Model Name	SP-LSP7TFA	SP-LSP9TFA
Display Resolution	3840 x 2160	
Lens	Fixed Lens	
Image Size (Diagonal)	90" ~ 120"	100" ~ 130"
Sound (Output)	30 W	40 W
Dimensions (W x H x D)		
Body	532.0 x 119.1 x 342.0 mm	550.0 x 128.0 x 367.0 mm
With Feet	532.0 x 132.7 x 342.0 mm	550.0 x 141.0 x 367.0 mm
Weight (With Feet)	9.1 kg	11.5 kg

## Environmental Considerations

Operating Temperature	10°C to 40°C (50°F to 104°F)
Operating Humidity	10% to 80%, non-condensing
Storage Temperature	-20°C to 45°C (-4°F to 113°F)
Storage Humidity	5% to 95%, non-condensing

- The design and specifications are subject to change without prior notice.
- This device is a Class B digital apparatus.
- For information about the power supply, and more information about power consumption, refer to the label-rating attached to the product.
  - For the label-rating and laser-related cautions, see the surface of the bottom of the projector.
- Typical power consumption is measured according to IEC 62087.
- The figures and illustrations in this User Manual are provided for reference only and may differ from the actual product appearance. The product design and specifications may change without notice.

Following the repair by a non-authorized service provider, self-repair or non-professional repair of the product, Samsung is not liable for any damage to the product, any injury or any other product safety issue caused by any attempt to repair the product which does not carefully follow these repair and maintenance instructions. Any damage to the product caused by an attempt to repair the product by any person other than a Samsung certified service provider will not be covered by the warranty.

Please visit [samsung.com/support](http://samsung.com/support) to find further information about external power adapter and remote control associated with EU Ecodesign directive - ErP regulation

## Decreasing power consumption

When you shut the TV off, it enters Standby mode. In Standby mode, it continues to draw a small amount of power. To decrease power consumption, unplug the power cable when you don't intend to use the TV for a long time.

## Licences

 **DOLBY AUDIO™**

POWERED BY

**QUICKSET®**

**rovi** guide

 **HEVC Advance™**  
Covered by Patents at [patentlist.hevcadvance.com](http://patentlist.hevcadvance.com)

**HDMI™**  
HIGH-DEFINITION MULTIMEDIA INTERFACE

The terms HDMI and HDMI High-Definition Multimedia Interface, and the HDMI Logo are trademarks or registered trademarks of HDMI Licensing LLC in the United States and other countries.

Hereby, Samsung declares that this radio equipment is in compliance with Directive 2014/53/EU and the relevant UK statutory requirements.

The full text of the declaration of conformity is available at the following internet address: <http://www.samsung.com> go to Support and enter the model name.

This equipment may be operated in all EU countries and in the UK.

The 5 GHz WLAN(Wi-Fi) function of this equipment may only be operated indoors.

BT max transmitter power : 100mW at 2.4GHz – 2.4835GHz

Wi-Fi max transmitter power : 100mW at 2.4GHz-2.4835GHz, 200mW at 5.15GHz-5.25GHz,

100mW 5.25GHz-5.35GHz & 5.47GHz - 5.725GHz



**Correct Disposal of This Product (Waste Electrical & Electronic Equipment)  
(Applicable in countries with separate collection systems)**

This marking on the product, accessories or literature indicates that the product and its electronic accessories (e.g. charger, headset, USB cable) should not be disposed of with other household waste at the end of their working life. To prevent possible harm to the environment or human health from uncontrolled waste disposal, please separate these items from other types of waste and recycle them responsibly to promote the sustainable reuse of material resources.

Household users should contact either the retailer where they purchased this product, or their local government office, for details of where and how they can take these items for environmentally safe recycling.

Business users should contact their supplier and check the terms and conditions of the purchase contract. This product and its electronic accessories should not be mixed with other commercial wastes for disposal.



**Correct disposal of the batteries in this product  
(Applicable in countries with separate collection systems)**

This marking on battery, manual or packaging indicates that the batteries in this product should not be disposed of with other household waste at the end of their working life. Where marked, the chemical symbols Hg, Cd or Pb indicate that the battery contains mercury, cadmium or lead above the reference levels in EC Directive 2006/66. If batteries are not properly disposed of, these substances can cause harm to human health or the environment.

To protect natural resources and to promote material reuse, please separate batteries from other types of waste and recycle them through your local, free battery return system.

# Warranty Card



United Kingdom



Republic of Ireland (EIRE)

This Samsung product is warranted for the period of twelve (12) months from the original date of purchase, against defective materials and workmanship. In the event that warranty service is required, you should return the product to the retailer from whom it was purchased. However, Samsung Authorised Dealers and Authorised Service Centres in the countries listed in Warranty Conditions will comply with the warranty on the terms issued to purchasers in the country concerned. In case of difficulty, details of our Authorised Service Centres are available from:

Samsung Electronics U.K. Ltd.  
Samsung Customer Support Centre  
Selectapost 38, Sheffield, S97 3FJ,  
United Kingdom

United Kingdom: Tel. 0333 000 0333  
[www.samsung.com/uk/support](http://www.samsung.com/uk/support)

EIRE: Tel. 0818 717100  
[www.samsung.com/ie/support](http://www.samsung.com/ie/support)

## WARRANTY CONDITIONS

1. The warranty is only valid if, when warranty service is required, the warranty card is fully and properly completed and is presented with the original invoice or sales slip or confirmation, and the serial number on the product has not been defaced.
2. Samsung's obligations are limited to the repair or, at its discretion, replacement of the product or the defective part. Repaired or replaced products may include new and or refurbished components and equipment.
3. Warranty repairs must be carried out by Authorised Samsung Dealers or Authorised Service Centres. No re-imbusement will be made for repairs carried out by non-Samsung Dealers and, any such repair work and damage to the products caused by such repair work will not be covered by this warranty.
4. This product is not considered to be defective in materials nor workmanship by reason that it requires adaptation in order to conform to national or local technical or safety standards in force in any Country other than the one for which the product was originally designed and manufactured.  
This warranty will not cover, and no re-imbusement will be made for such adaptation nor any damage which may result.
5. This warranty covers none of the following:
  - a) Periodic check-ups, maintenance and repair or replacement of parts due to normal wear and tear.
  - b) Cost relating to transport, removal or installation of the product.
  - c) Misuse, including the failure to use this product for its normal purposes or incorrect installation.
  - d) Use of this product in a commercial/ business environment, which shall include, but is not limited to, the following: any use for profit or financial gain, public display or events such as clubs, bars and restaurants including continuous statistical or graphical display, or any commercial use of continuous or intentional long term display of News reels ("tickers"), static or fixed images such as timetables and 4:3 pictures or video content displaying permanent black bars.
  - e) Damage caused by Lightning, Water, Fire, Acts of God, War, Public Disturbances, incorrect mains voltage, improper ventilation or any other cause beyond the control of Samsung.
  - f) Spillage of food or liquid or use of any other hazardous substances, which may affect the product.
  - g) Performance due to differences in broadcasting method between countries.
6. This warranty is valid for any person who legally acquired possession of the product during the warranty period.
7. The consumers' statutory rights in any applicable national legislation whether against the retailer arising from the purchase contract or otherwise are not affected by this warranty. Unless there is national legislation to the contrary, the rights under this warranty are the consumers' sole rights and Samsung, its subsidiaries and distributors shall not be liable for indirect or consequential loss or any damage to disc based media, removable memory or any other related equipment or material.
8. Some products may differ from these guidelines. Please check with your dealer or the local Samsung web-site.
9. Samsung shall honour warranties for all EU specification products purchased by a consumer within the following European countries listed.
  - UK, Republic of Ireland, Germany, France, Italy, Malta, Spain, Portugal, The Netherlands, Belgium, Luxembourg, Denmark, Sweden, Finland, Poland, Hungary, Czech Republic, Slovakia, Austria, Slovenia, Croatia, Estonia, Latvia, Lithuania, Greece, Cyprus, Romania, Bulgaria, Switzerland, Norway, Lichtenstein and Iceland.

SAMSUNG ELECTRONICS CO LTD.

# SAMSUNG



BP81-00249H-03

## Contact SAMSUNG WORLD WIDE

If you have any questions or comments relating to Samsung products, please contact the Samsung service centre.

Country	Samsung Service Centre ☎	Web Site
IRELAND (EIRE)	0818 717100	<a href="http://www.samsung.com/ie/support">www.samsung.com/ie/support</a>
UK	0333 000 0333	<a href="http://www.samsung.com/uk/support">www.samsung.com/uk/support</a>