

# IFP33/IFP33-G Series

## Commercial Touch Display User Guide

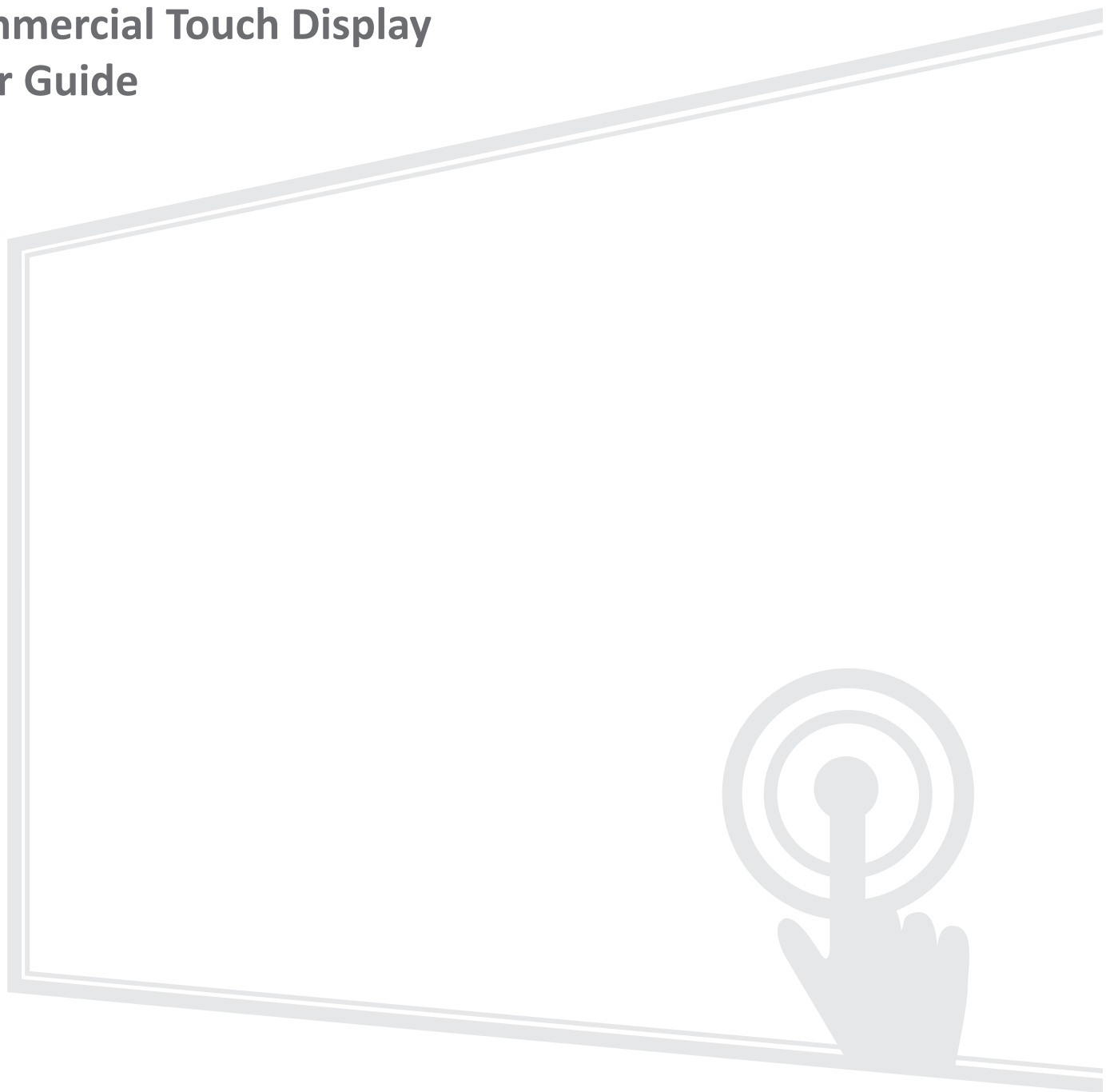

**IMPORTANT:** Please read this User Guide to obtain important information on installing and using your product in a safe manner, as well as registering your product for future service. Warranty information contained in this User Guide will describe your limited coverage from ViewSonic® Corporation, which is also found on our web site at <http://www.viewsonic.com> in English, or in specific languages using the Regional selection box of our website.

Model No. VS19493 | VS19494 | VS19495  
P/N: IFP6533/IFP6533-G | IFP7533/IFP7533-G | IFP8633/IFP8633-G

## **Thank you for choosing ViewSonic®**

As a world-leading provider of visual solutions, ViewSonic® is dedicated to exceeding the world's expectations for technological evolution, innovation, and simplicity. At ViewSonic®, we believe that our products have the potential to make a positive impact in the world, and we are confident that the ViewSonic® product you have chosen will serve you well.

Once again, thank you for choosing ViewSonic®!

# Safety Precautions

Please read the following **Safety Precautions** before you start using the device.

- Keep this user guide in a safe place for later reference.
- Read all warnings and follow all instructions.
- Do not use the device near water. To reduce the risk of fire or electric shock, do not expose the device to moisture.
- Never remove the rear cover. This display contains high-voltage parts. You may be seriously injured if you touch them.
- Avoid exposing the device to direct sunlight or other sources of sustained heat.
- Do not install near any heat sources such as radiators, heat registers, stoves, or other devices (including amplifiers) that may increase the temperature of the device to dangerous levels.
- Use a soft, dry cloth to clean the external housing. For more information, refer to the "Maintenance" section.
- When moving the device, be careful not to drop or bump the device on anything.
- Do not place the device on an uneven or unstable surface. The device may fall over resulting in an injury or a malfunction.
- Do not place any heavy objects on the device or connection cables.
- If smoke, an abnormal noise, or a strange odor is present, immediately turn the device off and call your dealer or ViewSonic®. It is dangerous to continue using the device.
- The device is a monitor with an LED backlight intended for general office use.
- Do not attempt to circumvent the safety provisions of the polarized or grounding-type plug. A polarized plug has two blades with one wider than the other. A grounding-type plug has two blades and a third grounding prong. The wide blade and the third prong are provided for your safety. If the plug does not fit into your outlet, obtain an adapter and do not attempt to force the plug into the outlet.
- When connecting to a power outlet, DO NOT remove the grounding prong. Please ensure grounding prongs are NEVER REMOVED.
- Protect the power cord from being treaded upon or pinched, particularly at the plug, and at the point where it emerges from the equipment. Ensure that the power outlet is located near the equipment so that it is easily accessible.
- Only use attachments/accessories specified by the manufacturer.
- When a cart is used, use with caution when moving the cart/equipment combination to avoid injury from tipping over.

- Disconnect the power plug from the AC outlet if the device is not being used for a long period of time.
- Place the device in a well-ventilated area. Do not place anything on the device that prevents heat dissipation.

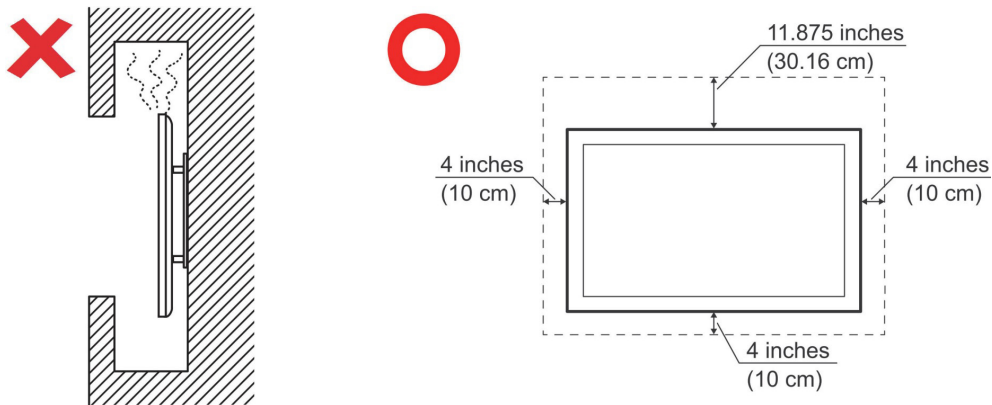

- Refer all servicing to qualified service personnel. Service will be required when the unit has been damaged in any way, such as:
  - » if the power supply cord or plug is damaged
  - » if liquid is spilled onto or objects fall in the unit
  - » if the unit is exposed to moisture
  - » if the unit does not operate normally or has been dropped

## IMPORTANT

To ensure the optimal performance and longevity of your display, it is essential to follow the recommended handling, mounting, and storage procedures. Placing the display in a horizontal position can lead to a range of potential issues, including:

- Excessive stress on the display's structural components, resulting in the formation of cracks or distortions along the edges.
- Uneven weight distribution, which can cause the screen to warp, sustain internal damage, or crack over time.
- Thermal-related damage, as the internal components may not be able to dissipate heat as intended, leading to potential failure or permanent damage.

Furthermore, altering the display's form can also compromise the integrity of its internal components, including the sensitive LCD cells, which can result in a permanent degradation of the display's quality.

To prevent such issues and maintain the display's optimal condition, it is recommended to always mount, handle, transport, and store it in a vertical position. Failure to do so may void the warranty and compromise the display's performance and lifespan.

**NOTE:** Any damage resulting from the misuse or improper handling of the display is not covered under warranty.

# Contents

<b>Safety Precautions.....</b>	<b>3</b>
<b>Introduction .....</b>	<b>9</b>
Package Contents .....	9
Wall Mount Kit Specifications (VESA) .....	10
IFP6533.....	10
IFP7533.....	11
IFP8633.....	12
Product Overview .....	13
IFP6533.....	13
IFP7533.....	14
IFP8633.....	15
Control Panel and Front I/O .....	16
I/O Panel.....	17
Remote Control .....	18
Using Gestures .....	22
<b>Making Connections .....</b>	<b>24</b>
Connecting External Devices and Touch Connection .....	24
Type C Connection .....	24
HDMI Connection .....	24
VGA Connection .....	25
RS-232 Connection .....	26
USB and Networking Connections .....	27
Media Player Connection .....	28
Audio Connection.....	29
Audio In .....	29
Audio Out .....	29
SPDIF Connection .....	30
Video Output Connection .....	31

<b>Using Your ViewBoard.....</b>	<b>32</b>
Powering On/Off your ViewBoard.....	32
Initial Launch Setup .....	33
Toolbar .....	35
Control Bar .....	41
On-Screen Display (OSD) Menu - General Settings .....	44
Input Settings .....	45
Display Settings .....	47
Audio Settings .....	50
Low Blue Light Filter and Eye Health .....	52
Settings - ViewBoard Input Source .....	54
Network & Internet .....	54
File Sharing .....	62
Display .....	64
Preference .....	68
Input Source .....	76
Apps .....	79
System .....	82

## **Pre-installed Applications and Settings..... 90**

myViewBoard Display.....	90
myViewBoard Live .....	91
myViewBoard Manager .....	92
myViewBoard Record .....	93
myViewBoard Whiteboard .....	94
vCast .....	97
Display Group Settings .....	99
Synchronized Group Screen All the Time .....	101
Share a Screen to the Display Group (One to Many Casting).....	101
Moderator Mode .....	102
Broadcast .....	103
Multiple Screen Sharing .....	103
Preview Screen.....	103
Touch.....	103
Casting from Windows, MacBook, and Chrome Devices .....	104
Casting from Android Devices .....	106
Casting from Apple iOS Devices .....	109
Connecting to a ViewBoard from a Mobile Device .....	112
Casting with Chromecast.....	113
Casting with Miracast.....	115
Other Default Applications .....	117
Chromium.....	117
Folders.....	118
OfficeSuite.....	120
PIP (Picture-in-Picture).....	121
Screen Lock .....	124
vSweeper.....	125

## **RS-232 Protocol..... 126**

Description .....	126
RS-232 Hardware Specification .....	126
LAN Hardware Specification.....	127
RS232 Communication Setting.....	127
LAN Communication Setting .....	127
Command Message Reference.....	127
Protocol .....	128
Set-Function Listing.....	128
Get-Function Listing .....	136
Remote Control Pass-through Mode .....	144

<b>Appendix.....</b>	<b>147</b>
Specifications.....	147
Display Modes .....	149
VGA Mode .....	149
HDMI Mode.....	149
Troubleshooting .....	150
Maintenance.....	152
General Precautions .....	152
Cleaning the Screen.....	152
Cleaning the Case .....	152
<b>Regulatory and Service Information .....</b>	<b>153</b>
Compliance Information.....	153
FCC Compliance Statement.....	153
Industry Canada Statement.....	153
CE Conformity for European Countries .....	153
Declaration of RoHS2 Compliance.....	154
ENERGY STAR Statement.....	155
Indian Restriction of Hazardous Substances .....	156
Product Disposal at End of Product Life .....	156
Copyright Information .....	157
Customer Service .....	158
Limited Warranty .....	159
Mexico Limited Warranty.....	162



# Introduction

## Package Contents

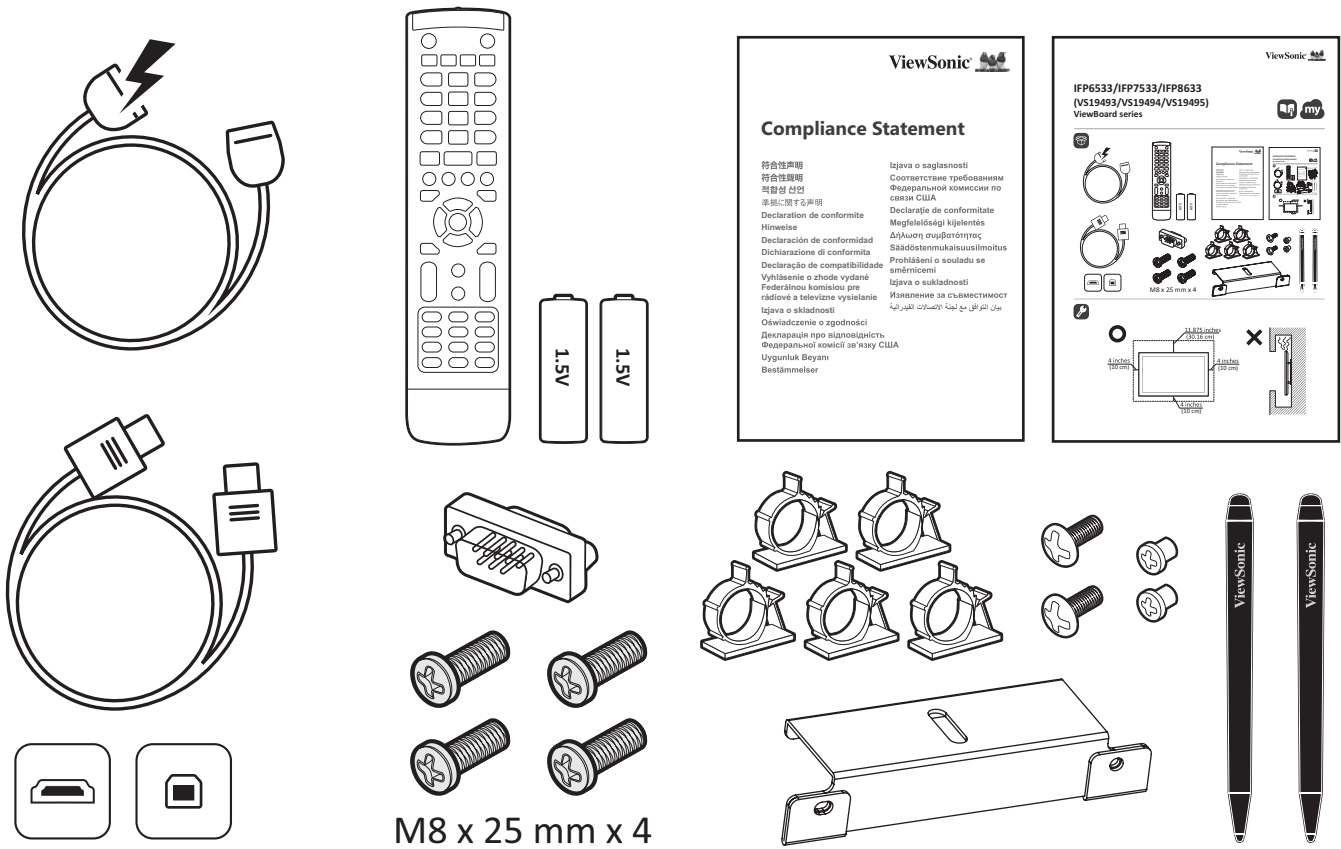

- Power Cord (3 m)
- Remote Control
- AAA Battery
- USB Touch Cable (3 m)
- Touch Pen x 2 (VP-PEN-009)
- Quick Start Guide
- Compliance Statement
- RS-232 Adapter
- Clamp x 5
- Camera Plate
- Screw x 8
- HDMI Cable (3 m)

**NOTE:** The power cord and video cables included in your package may vary depending on your country. Please contact your local reseller for more information.

# Wall Mount Kit Specifications (VESA)

**NOTE:** Please follow the instructions in the wall mount installation guide to install your wall mount or mobile mount bracket. If attaching to other building materials, please contact your nearest dealer.

## IFP6533

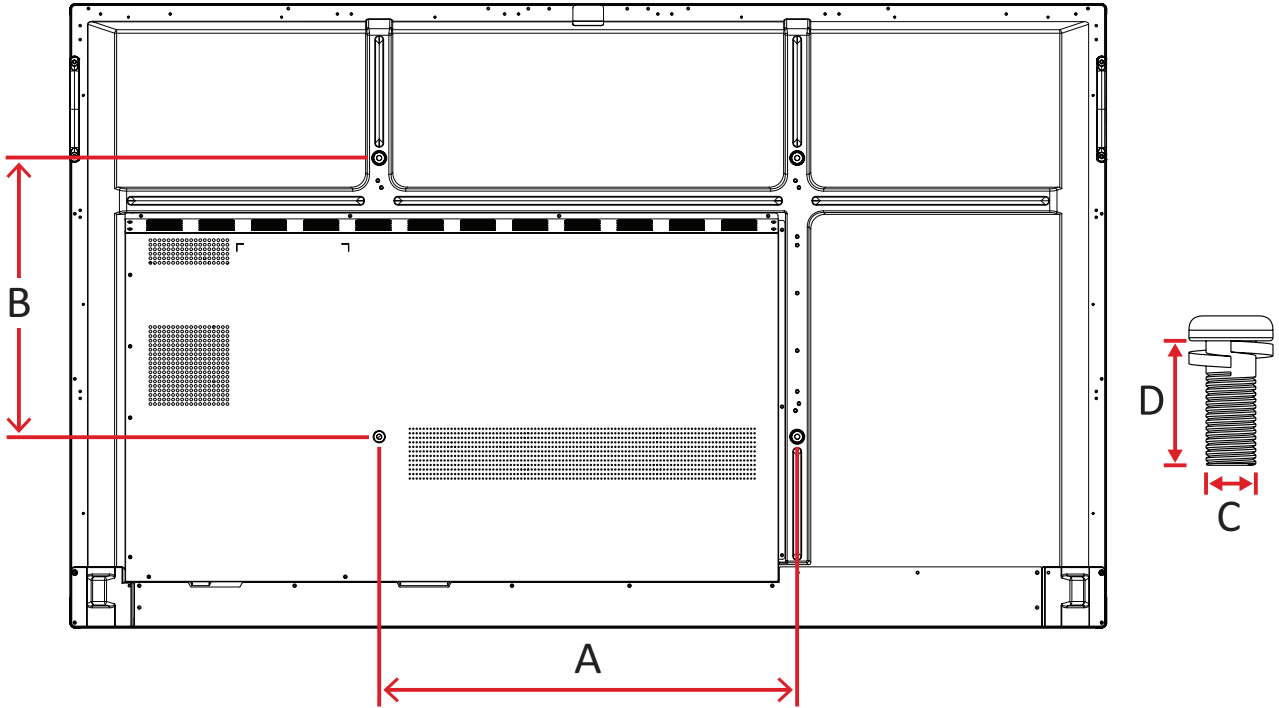

Model	VESA Spec. (A x B)	Standard Screw (C x D)	Quantity
IFP6533- 65"	600 x 400 mm	M8 x 25 mm	4

**NOTE:**

- Do not use screws that are longer than the standard dimension, as they may cause damage to the inside of the display.
- Only mount the display in landscape orientation. Never mount in a portrait orientation.

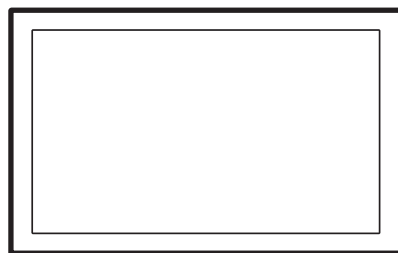
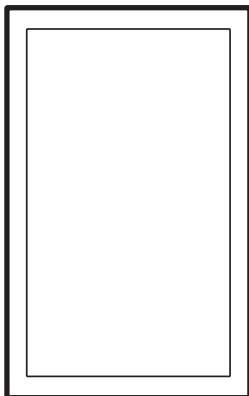

# IFP7533

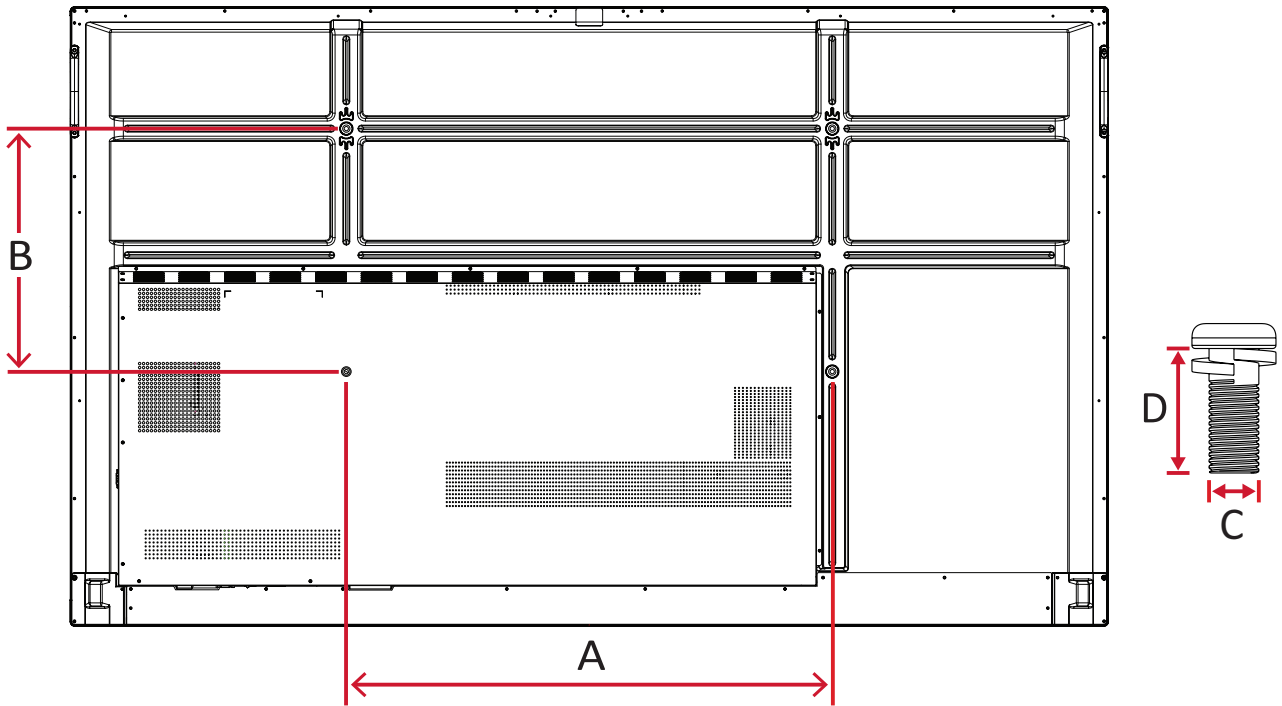

Model	VESA Spec. (A x B)	Standard Screw (C x D)	Quantity
IFP7533 - 75"	800 x 400 mm	M8 x 25 mm	4

### NOTE:

- Do not use screws that are longer than the standard dimension, as they may cause damage to the inside of the display.
- Only mount the display in landscape orientation. Never mount in a portrait orientation.

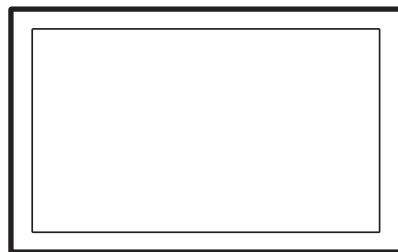
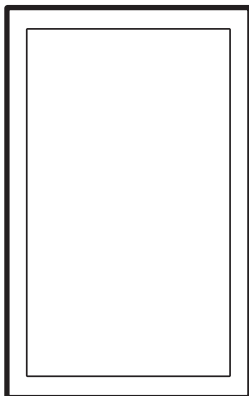

# IFP8633

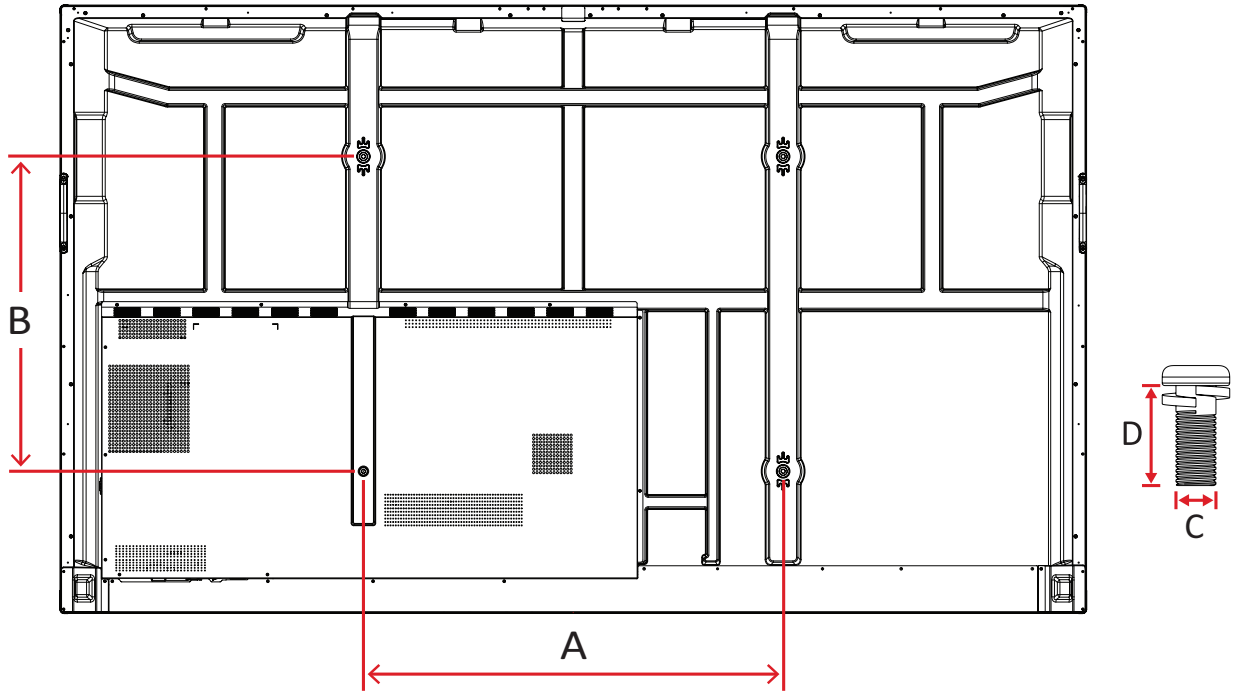

Model	VESA Spec. (A x B)	Standard Screw (C x D)	Quantity
IFP8633 - 86"	800 x 600 mm	M8 x 25 mm	4

## NOTE:

- Do not use screws that are longer than the standard dimension, as they may cause damage to the inside of the display.
- Only mount the display in landscape orientation. Never mount in a portrait orientation.

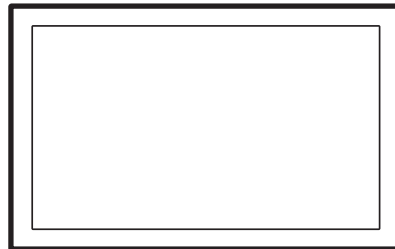
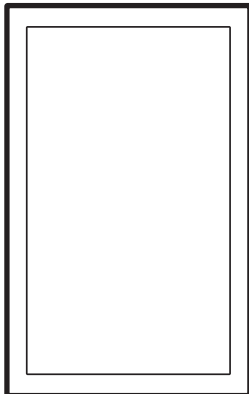

# Product Overview

## IFP6533

### Front Panel



Control Panel and Front I/O

### Rear Panel

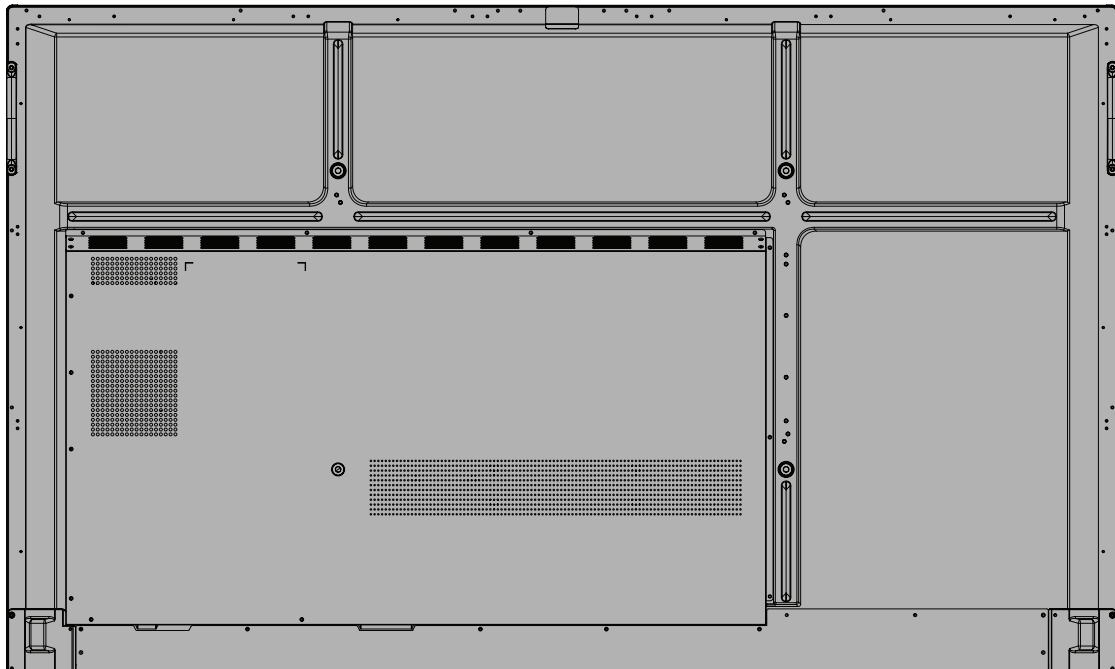

# IFP7533

## Front Panel



Control Panel and Front I/O

## Rear Panel

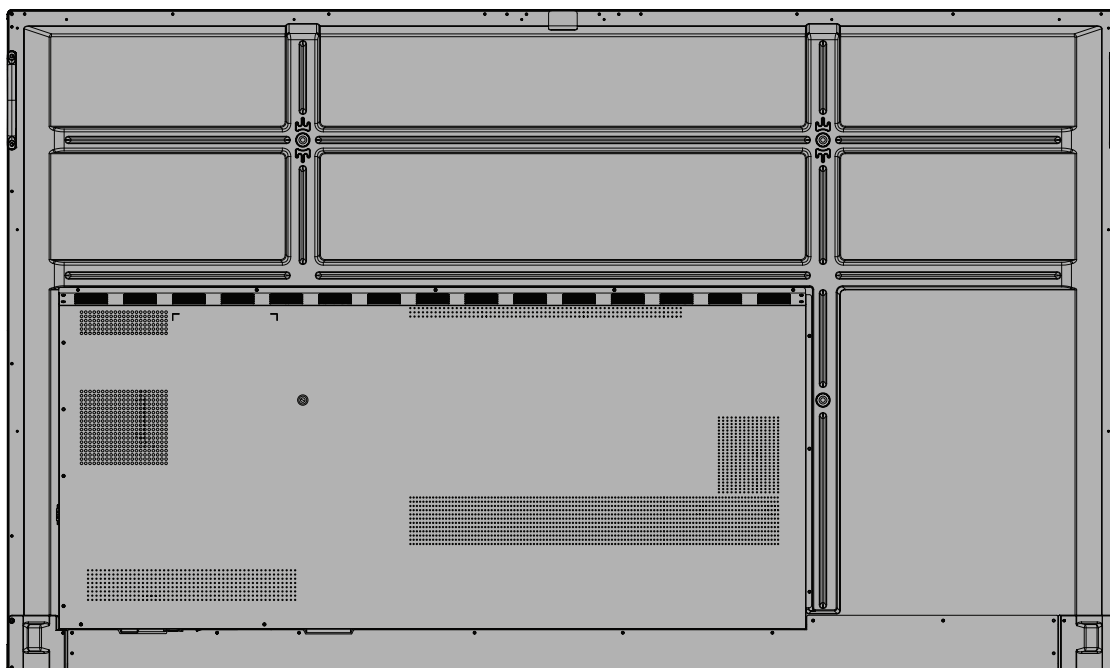

# IFP8633

## Front Panel







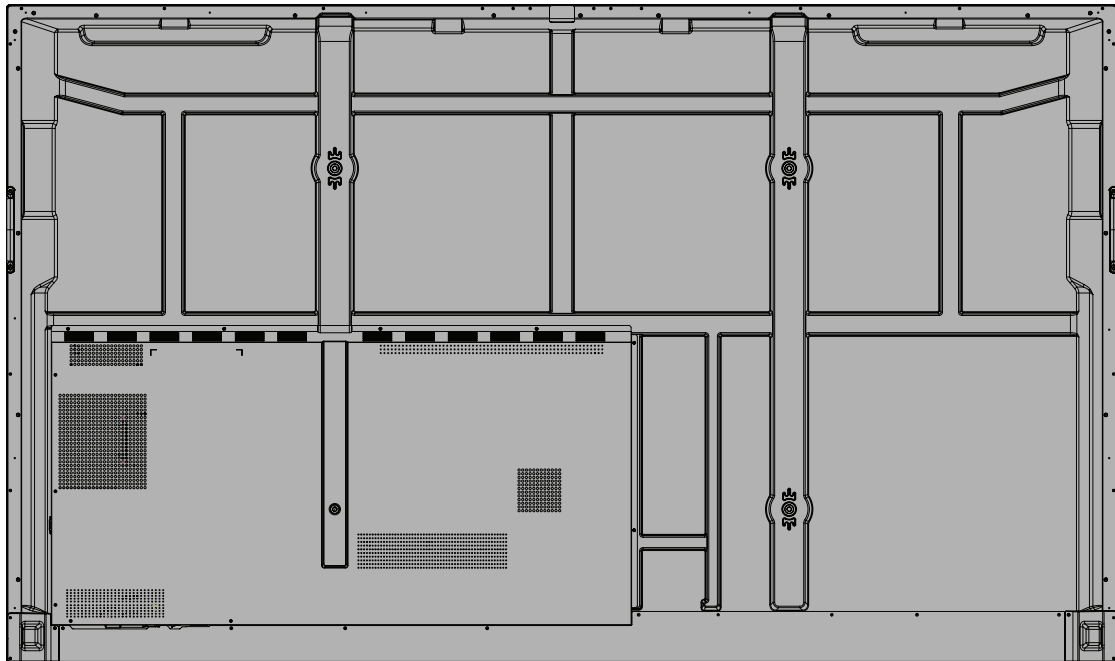

Control Panel and Front I/O

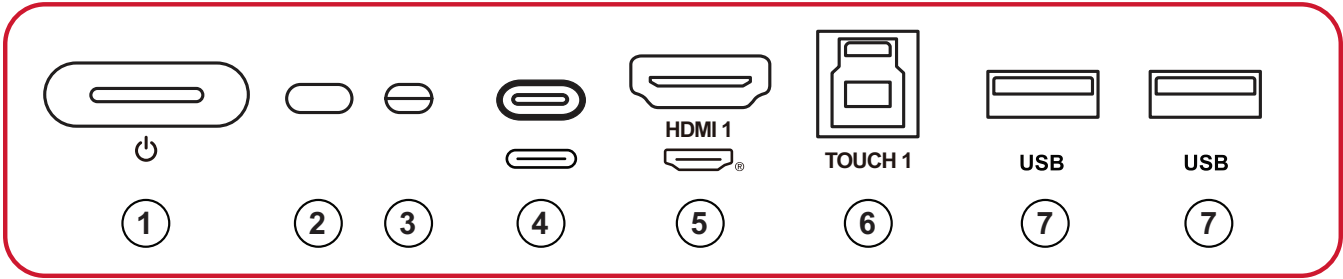
## Rear Panel

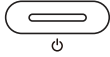

## Control Panel and Front I/O



Number	Item	Description
1		<ul style="list-style-type: none"> <li>• Press to turn on the device</li> <li>• Press to turn off/on the display backlight only</li> <li>• Press and hold to turn off the device</li> </ul>
2		Remote control receiver
3		Ambient light sensor
4		<ul style="list-style-type: none"> <li>• USB Type C input</li> <li>• Connect to a PC with USB Type C output</li> </ul>
5		<ul style="list-style-type: none"> <li>• High definition input</li> <li>• Connect to a PC with HDMI output, set-top box, or other video device.</li> </ul>
6		Touch signal output to external PC <b>NOTE: Pairs with HDMI 1.</b>
7		<ul style="list-style-type: none"> <li>• USB Type A input</li> <li>• Connect USB devices such as hard disks, keyboard, mouse, etc.</li> </ul>





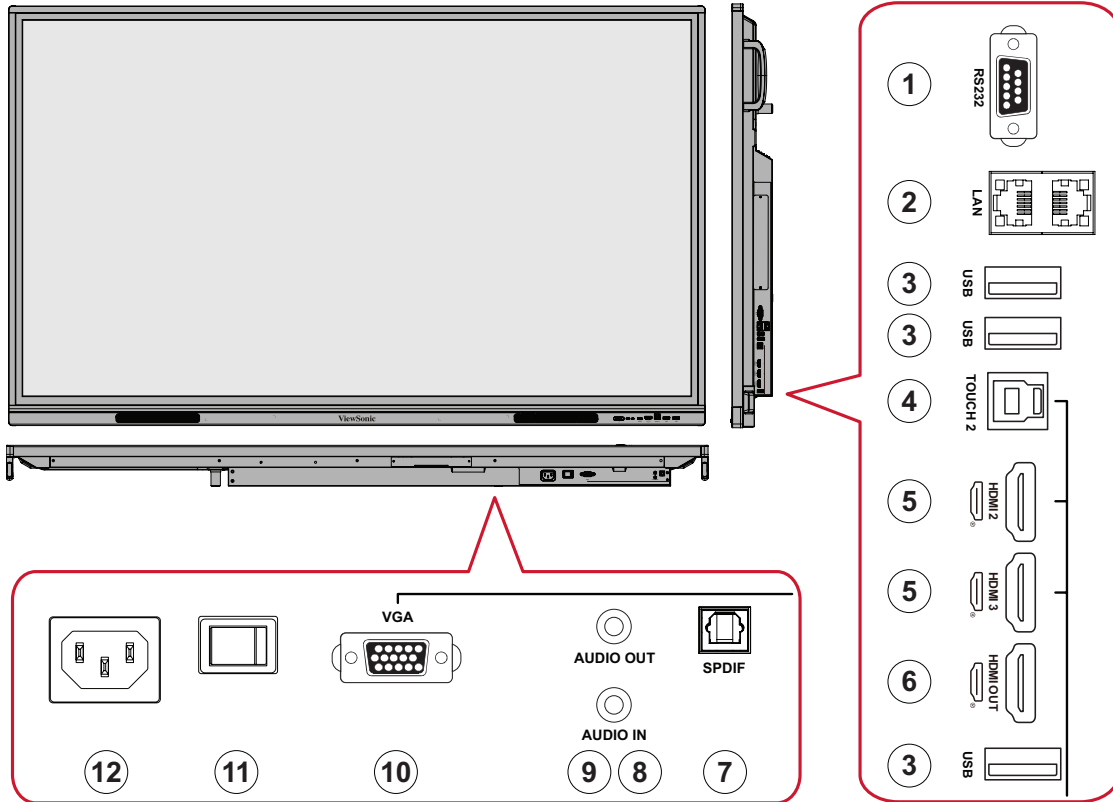





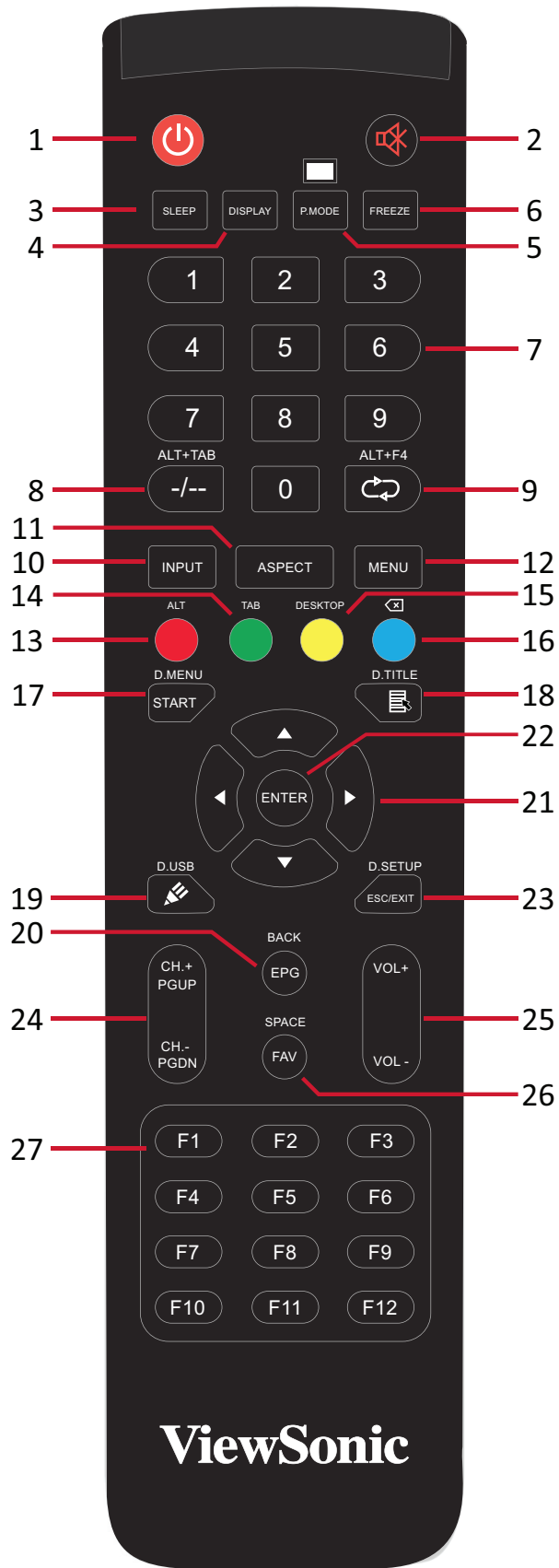

# I/O Panel



Number	Item	Description
1	RS-232	<ul style="list-style-type: none"> <li>Serial interface</li> <li>For mutual transfer of data between devices</li> </ul>
2	LAN	<ul style="list-style-type: none"> <li>Standard RJ45 (10M/100M/1G) internet</li> <li>For ViewBoard and Slot-in PC use</li> </ul>
3	USB Type A	<ul style="list-style-type: none"> <li>USB Type A input</li> <li>Connect USB devices such as hard disks, keyboard, mouse, etc.</li> </ul>
4	TOUCH 2	Touch signal output to external PC <b>NOTE: Pairs with HDMI 2/HDMI 3/VGA.</b>
5	HDMI 2/3	<ul style="list-style-type: none"> <li>High definition input</li> <li>Connect to a PC with HDMI output, set-top box, or other video device</li> </ul>
6	HDMI OUT	Extend content out to another display device
7	SPDIF	SPDIF output
8	AUDIO OUT	Audio out to an external speaker
9	AUDIO IN	External PC audio input
10	VGA	External PC image input
11	Power Switch	Turn On/Off AC power supply
12	AC IN	AC power input

# Remote Control



Number	Item	Description
1		Power on/off
2		Mute/Unmute
3	SLEEP	Sleep Mode
4	DISPLAY	For Non-Android sources; display current input source information
5	P.MODE	Blank Screen
6	FREEZE	Freeze Screen
7		Numeric input buttons
8	ALT+TAB -/--	Slot-in computer space bar Alt+Tab
9	ALT+F4 	Slot-in computer, close program window
10	INPUT	Input source selection
11	ASPECT	Back to slot-in system main interface
12	MENU	For Android, access Settings; for other sources, access Touch Menu settings
13	Red / ALT	Screen capture
14	Green / TAB	PC <sup>1</sup> [Tab] button
15	Yellow / DESKTOP	Switch to slot-in PC desktop
16	BLUE/ 	PC <sup>1</sup> [Backspace] button
17	START / D.MENU	PC <sup>1</sup> [Windows] button
18	 / D.TITLE	PC <sup>1</sup> [Menu] button
19	 / D.USB	Writing software setup
20	EPG/BACK	Return button
21	 /  /  / 	Scroll up, down, left, and right
22	ENTER	Confirm selection/state
23	ESC / EXIT / D.SETUP	Shortcut button to exit dialogue boxes
24	CH.+ / PGUP / CH.- / PGDN	CH+: PC previous page CH-: PC next page
25	VOL+ / VOL-	Increase/Decrease volume
26	FAV / SPACE	PC <sup>1</sup> [Space] button
27	F1-F12	Built-in computer F1 - F12 function button

<sup>1</sup> All computer-related function keys are not available without a slot-in computer.

## Inserting Remote Control Batteries

To insert batteries into the remote control:

1. Remove the cover on the rear of the remote control.
2. Insert two “AAA” batteries, ensuring the “+” symbol on the battery matches the “+” on the battery post.
3. Replace the cover by aligning it with the slot on the remote control and snapping the latch shut.

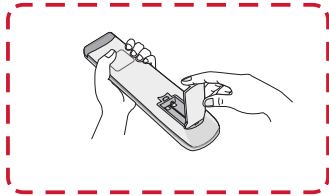

(1)

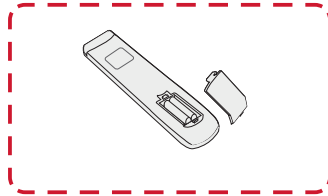

(2)

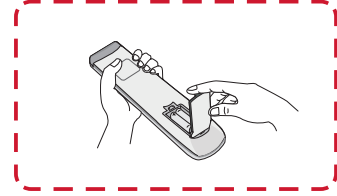

(3)

**WARNING:** There is a risk of explosion if batteries are replaced with the incorrect type.

### NOTE:

- It is recommended that you do not mix battery types.
- Always dispose of old batteries in an environmentally friendly way. Contact your local government for more information on how to dispose of batteries safely.

## Remote Control Receiver Range

The working range of the remote control is shown here. It has an effective range of 8 meters, 30° degrees left and right. Ensure there is nothing obstructing the remote control's signal to the receiver.

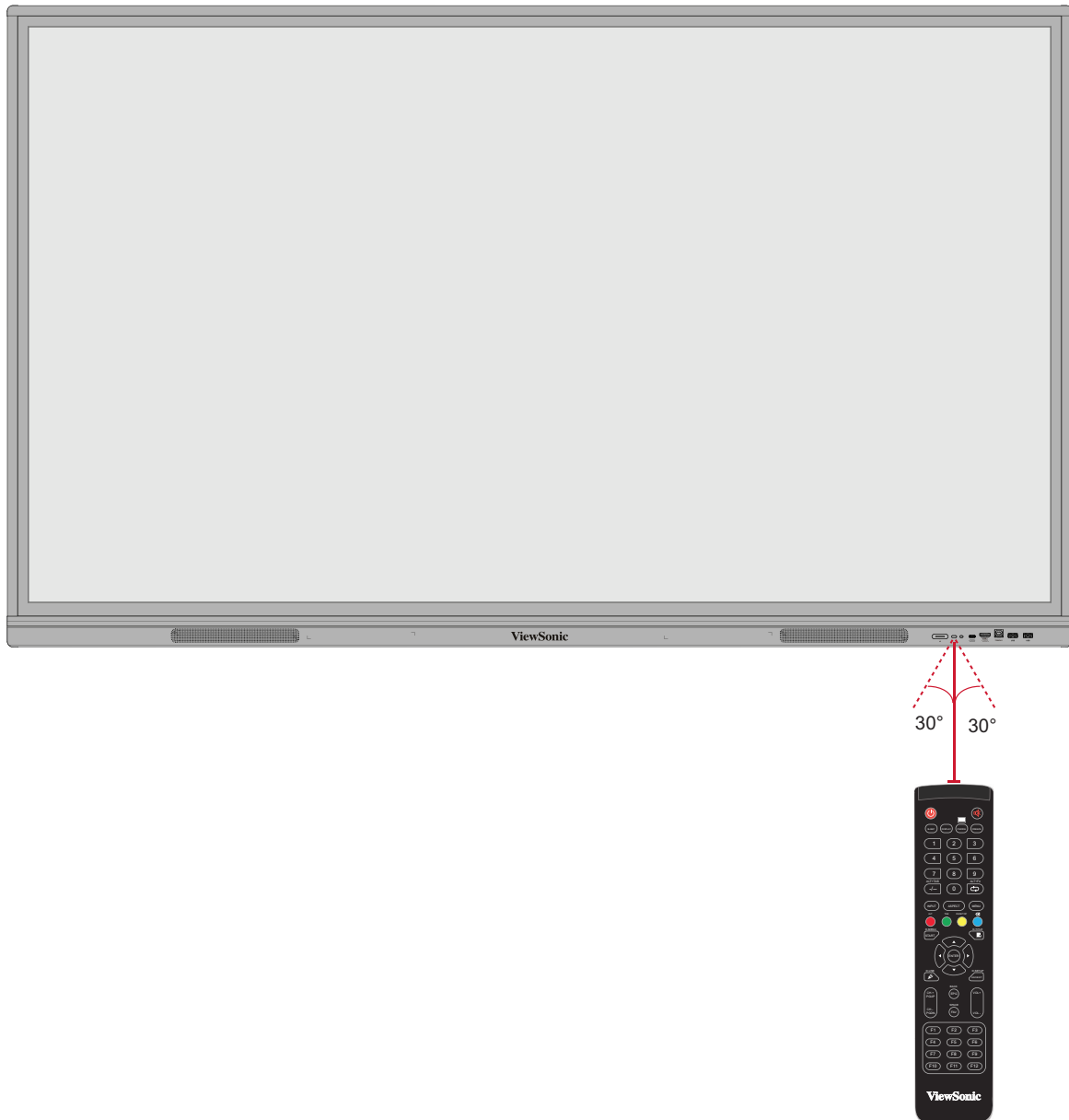

## Using Gestures

Touch gestures allow the user to use pre-determined commands without using a keyboard or mouse. Using gestures on the ViewBoard, the user can select/deselect objects, change the location of an object, access settings, erase digital ink, and much more.

### Select and Deselect an Object (Clicking)

Press and release the ViewBoard to select/deselect options or objects. This is like a single, standard left mouse click.

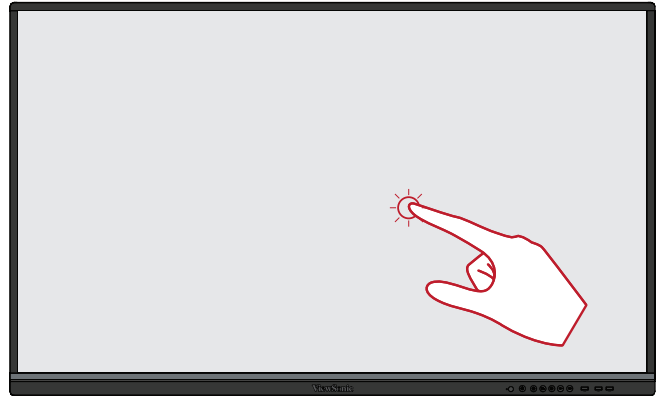

### Display Menu Options (Right-Clicking)

Press and hold the ViewBoard with your finger. This is like a single, standard right mouse click.

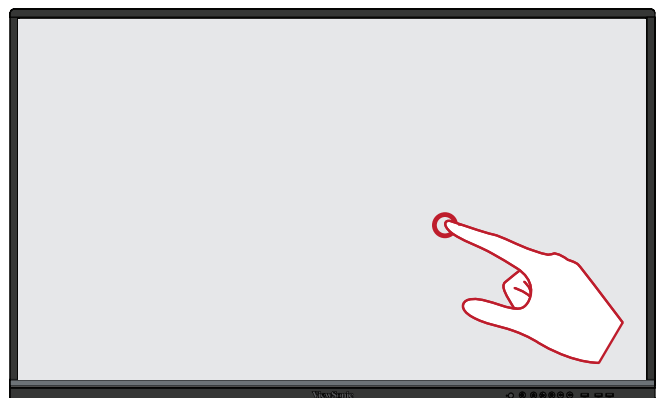

### Double-Clicking

Quickly press and release twice in the same location on the ViewBoard. This is like a double, standard left mouse click.

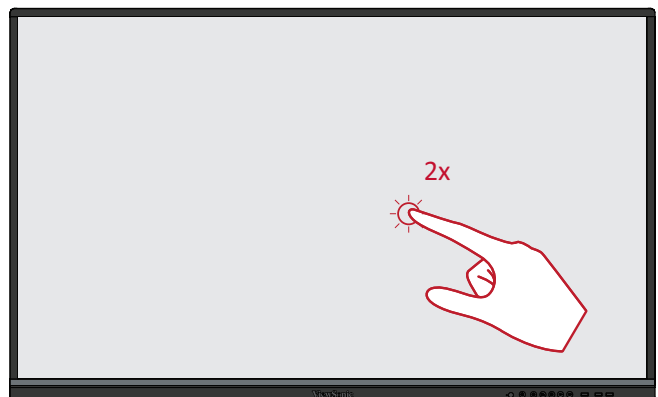

## Moving an Object

Press and hold the object on the ViewBoard and slowly drag it with your finger to your desired location.



## Erasing Digital Ink

Use your flattened hand, palm, or fist on the ViewBoard and move your hand across the area which you wish to erase.

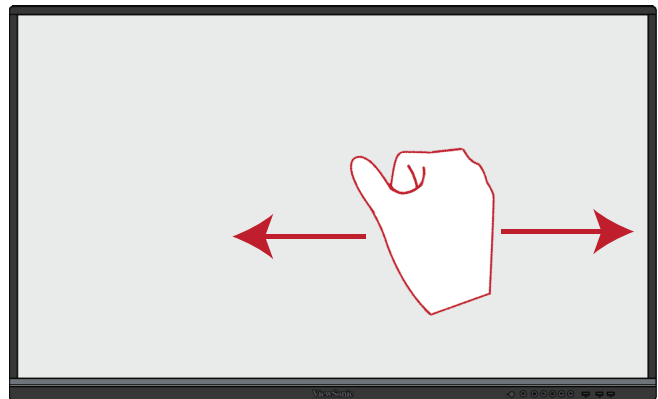

## Swipe Up for General Settings

Swipe up from the bottom of the ViewBoard to launch the General Settings.

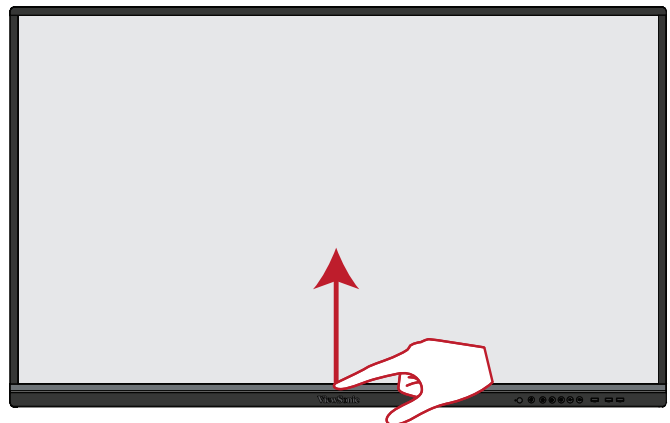

# Making Connections

## Connecting External Devices and Touch Connection

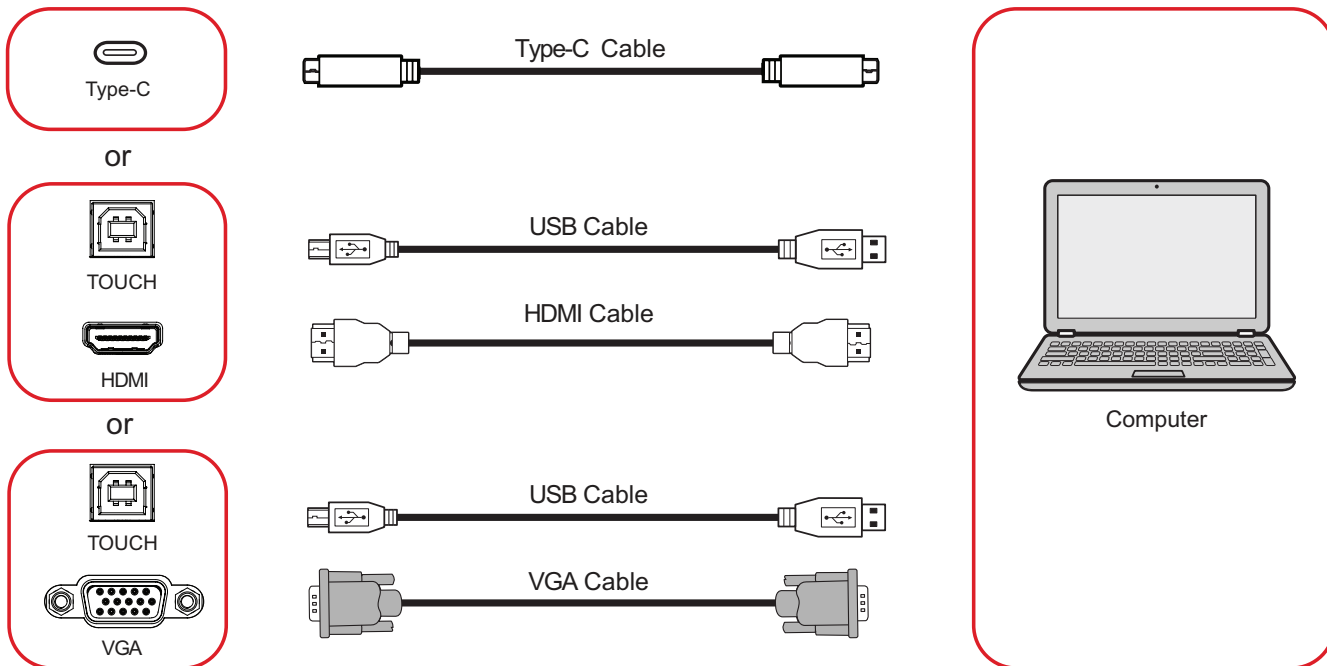

Your external device(s) can be connected in any of the following configurations:

### Type C Connection

To connect via Type C:

Connect a Type C cable from your external device to the **Type C** port on the ViewBoard.

### HDMI Connection

To connect via HDMI:

1. Connect an HDMI cable from your external device to the **HDMI 1/2/3** port on the ViewBoard.
2. Connect a USB cable to the external device from the **TOUCH** port of the ViewBoard.

**NOTE:** The **TOUCH 1** port is for the **HDMI 1** port. The **TOUCH 2** port is for the **HDMI 2** and **HDMI 3** ports.



## VGA Connection

To connect via VGA:

1. Connect a VGA cable from your external device to the **VGA** port on the ViewBoard.
2. Connect a USB cable to the external device from the **TOUCH 2** port of the ViewBoard.

**NOTE:** The **TOUCH 1** port is for the **HDMI 1** port. The **TOUCH 2** port is for the **HDMI 2, HDMI 3, and VGA** ports.

## RS-232 Connection

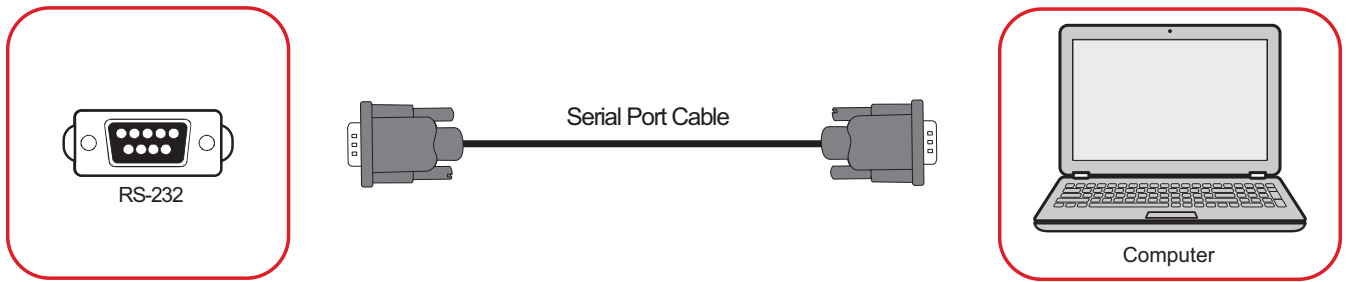

When you use a RS-232 serial port cable to connect your display to an external computer certain functions can be controlled remotely by the PC, including Power On/Off, Volume adjustment, Input select, Brightness, and more.

## USB and Networking Connections

Just like any PC, it is easy to connect various USB devices and other peripherals to your ViewBoard.

### USB Peripherals

Plug the USB device into a **USB** port.

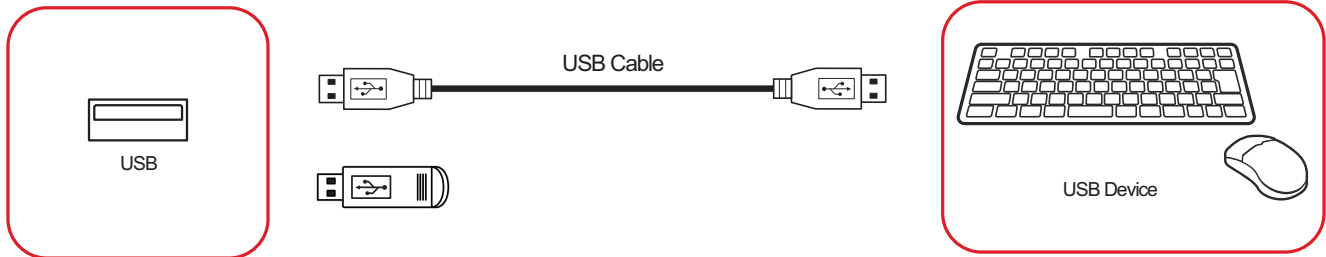

### Networking and Modem cables

Plug the network cable into a **LAN** port.

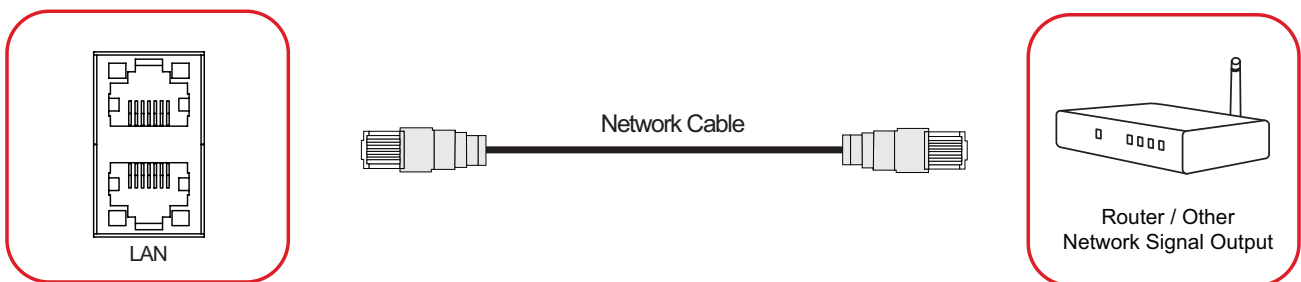

## Media Player Connection

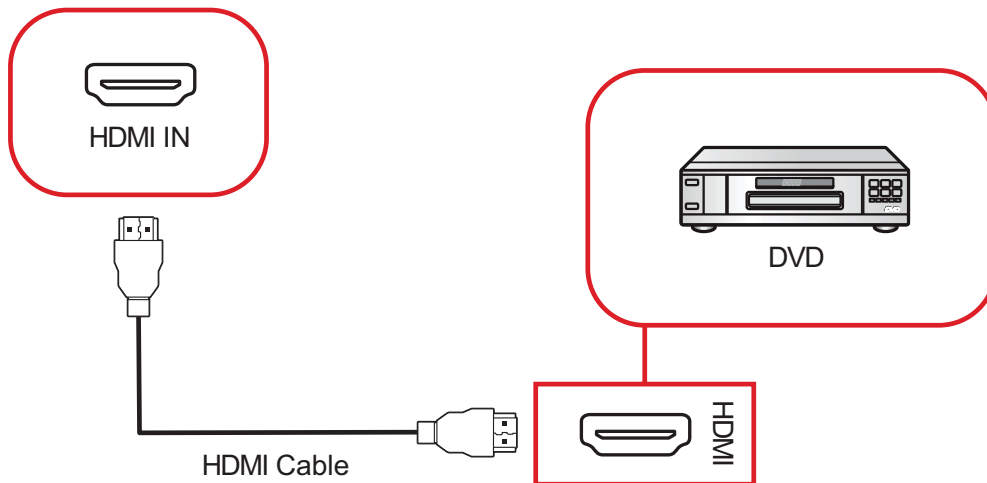

To connect to a media player:

1. Connect the HDMI cable to the **HDMI IN** port on your ViewBoard and peripheral device.
2. Plug in the power cord of your ViewBoard, and turn on the power supply switch.
3. Press the **Power** button on the right-hand side of the ViewBoard to turn the screen on.
4. Press the **INPUT** button on the remote control and switch to the "HDMI" input source.

## Audio Connection

The ViewBoard supports **Audio In**, **Audio Out**, and **SPDIF**.

### Audio In

To play audio from your external device through the ViewBoard's speakers, connect one end of an audio cable to your external device, and the other end to the ViewBoard's **AUDIO IN** port.

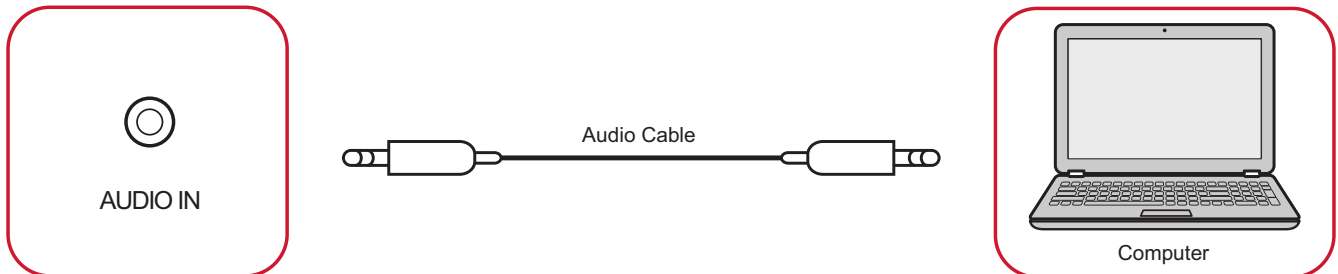

### Audio Out

To play audio from the ViewBoard through an external speaker, connect one end of an audio cable to the external speaker, and the other end to the ViewBoard's **AUDIO OUT** port.

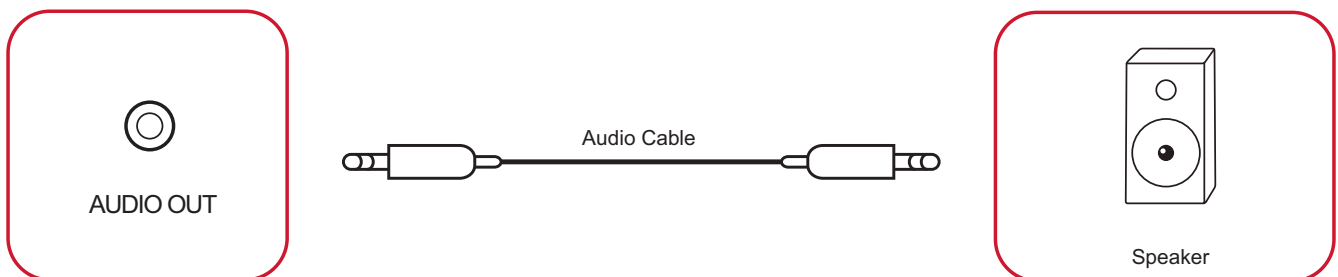

## SPDIF Connection

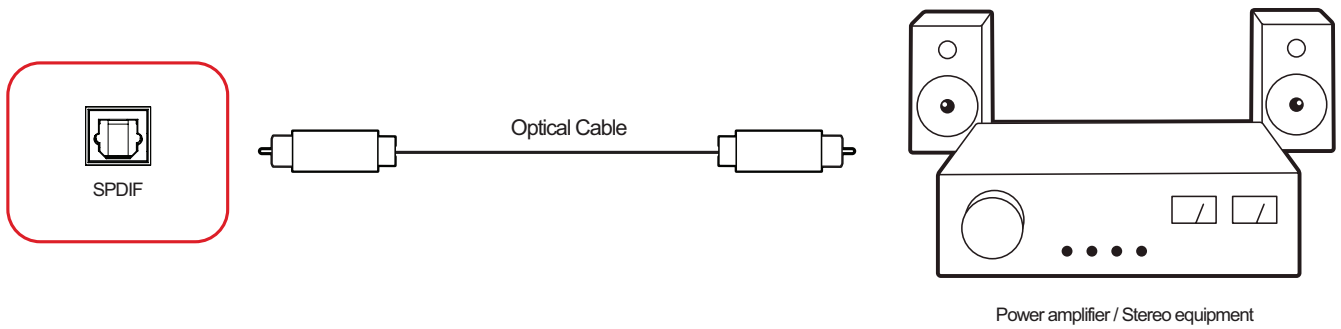

To connect to an external sound system:

1. Connect an optical cable from the **SPDIF** port to your sound system's optical connector.
2. Plug in the power cord of your ViewBoard, and turn on the rear-panel power supply switch.
3. Press the **Power** button on the right-hand side of the ViewBoard to turn the screen on.

## Video Output Connection

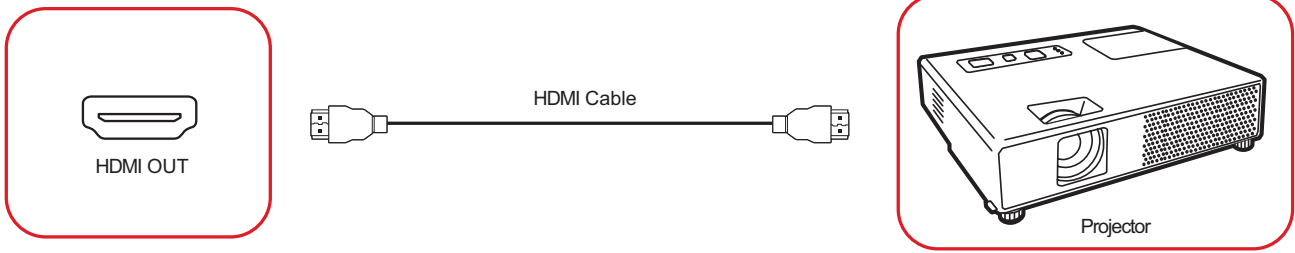

To output video via a display device:

1. Connect an HDMI cable to the **HDMI IN** port of your display device, and the other end to the **HDMI OUT** port of your ViewBoard.
2. Plug in the power cord of your ViewBoard, and turn on the power supply switch.
3. Press the **Power** button on the right-hand side of the ViewBoard to turn the screen on.
4. Press the **INPUT** button on the remote control and switch to the "HDMI IN" input source.

# Using Your ViewBoard

## Powering On/Off your ViewBoard

1. Ensure the power cord is connected, plugged into a power outlet, and the power switch is in the “On” position.



The AC Power input and switch are located at the bottom of the unit.

2. Press the **⏻ Power** button to turn on the ViewBoard.
3. To turn the ViewBoard off, press and hold the **⏻ Power** button.



# Initial Launch Setup

When you first turn on your ViewBoard, an initial setup wizard will launch.

## 1. Select your Language.

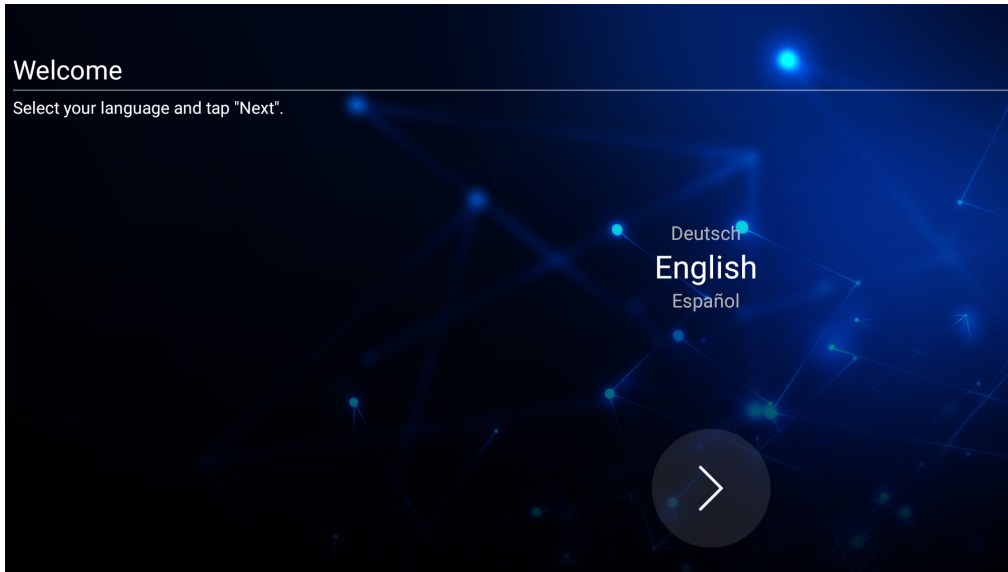

## 2. Setup and verify your LAN connection.

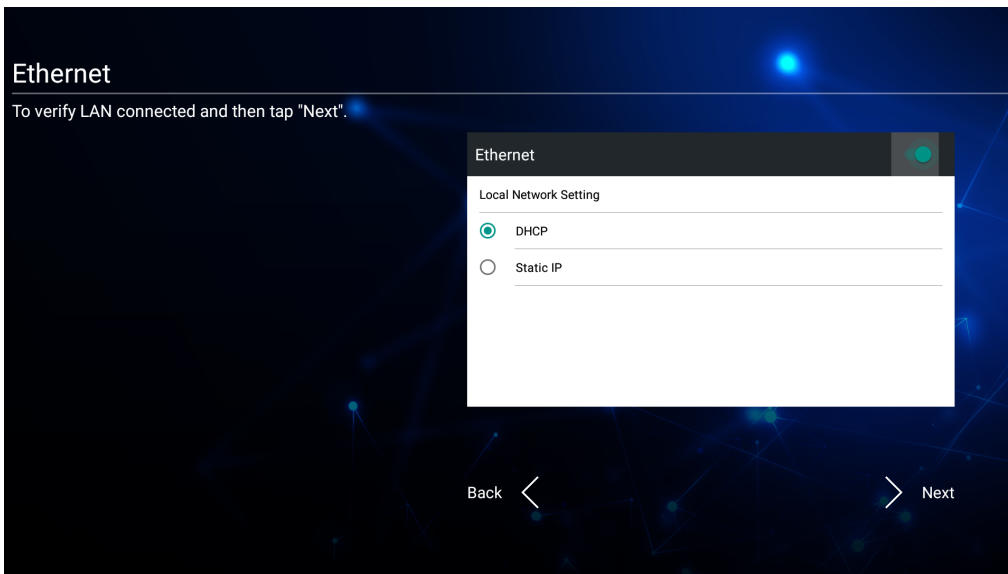

### 3. Select your Time Zone to set the Date and Time.

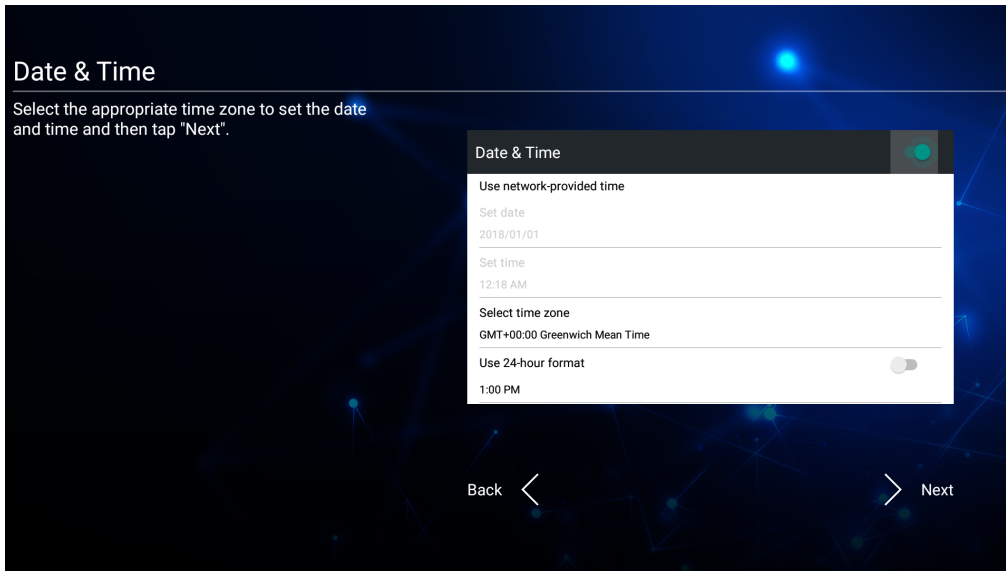

### 4. Select your preferred System Mode.

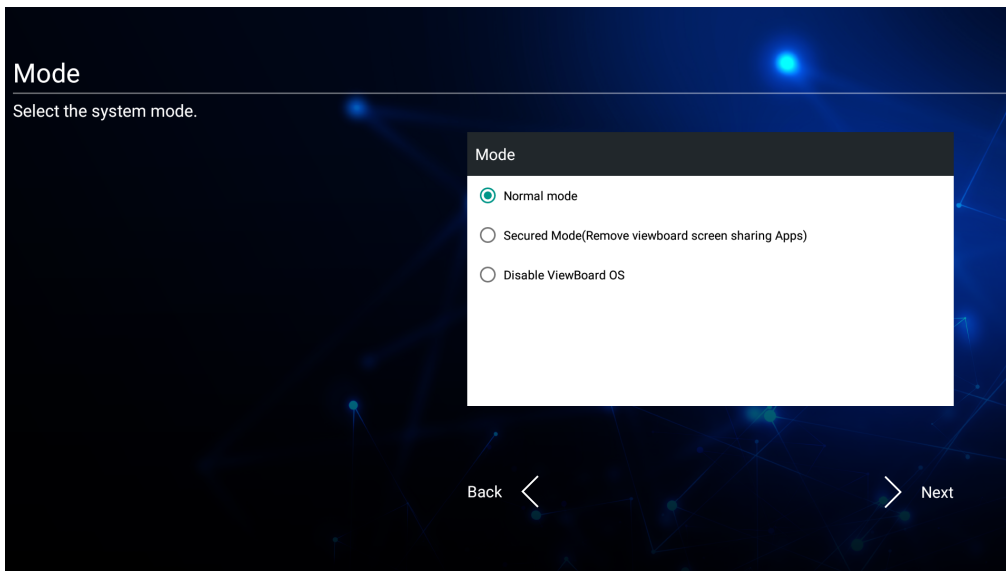

### 5. Accept or Decline the Privacy and Copyright Protection Terms.

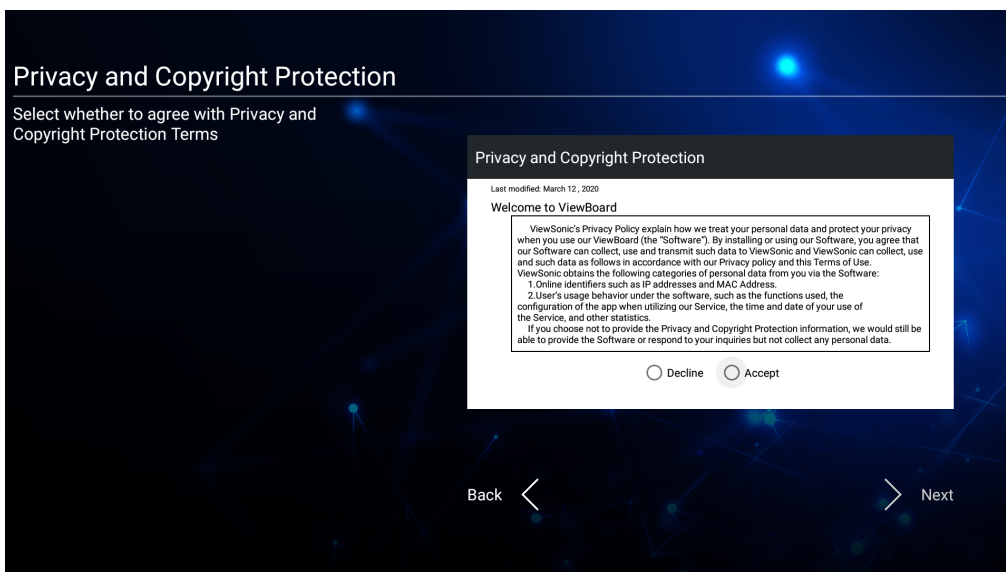

# Toolbar

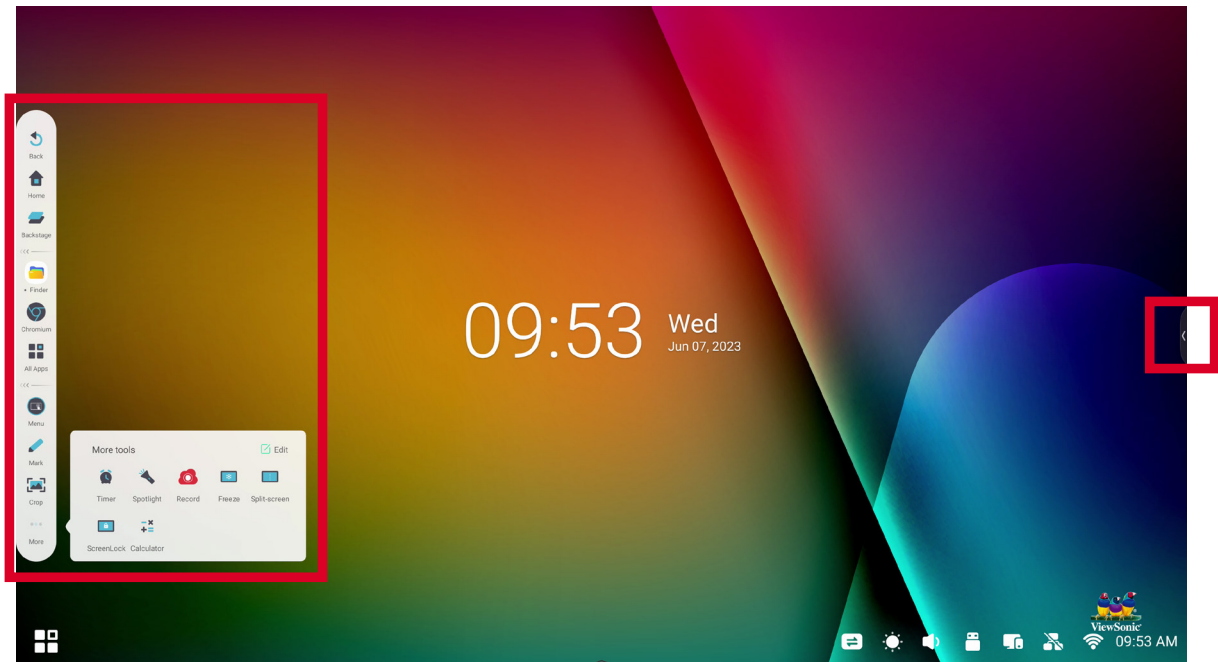

The Toolbar is where your applications and tools can be found. Trigger icons are on the edge of the launcher for quick access.





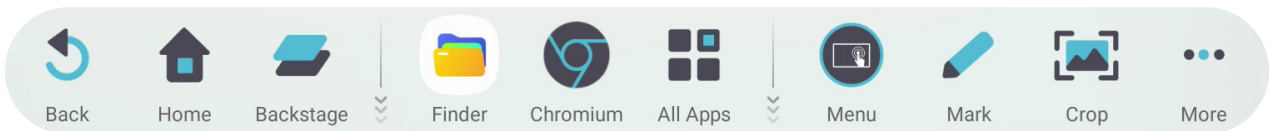

To launch an application or tool:

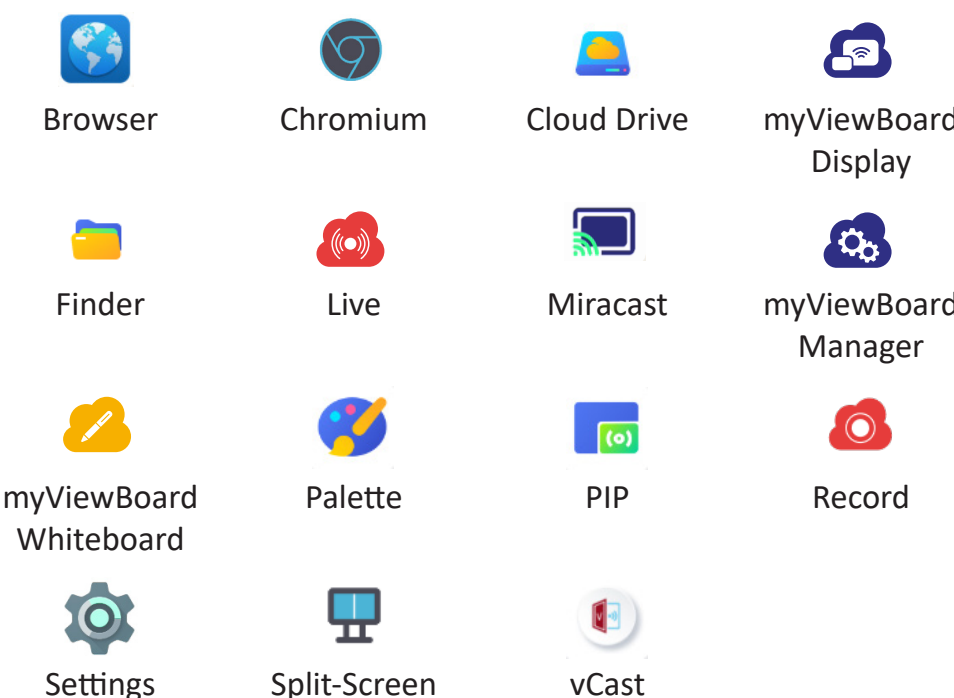

1. Tap a Toolbar trigger icon.
2. Tap on your desired application or tool icon.







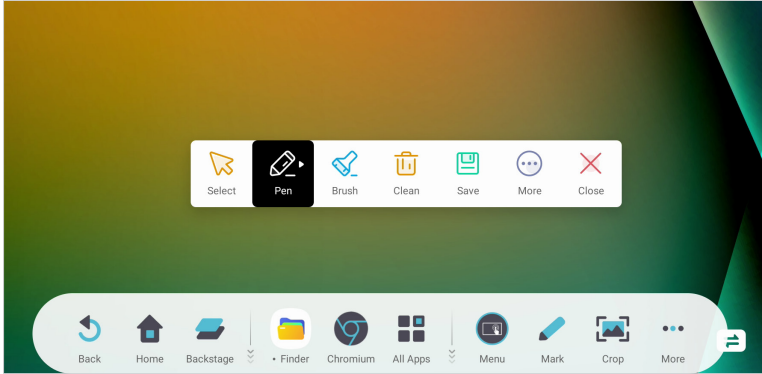

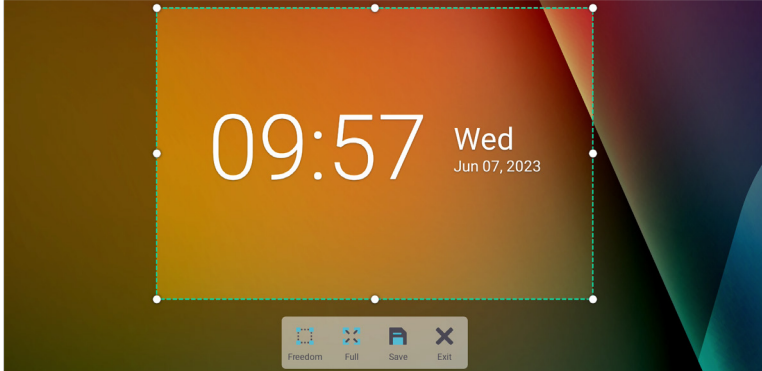
Icon	Description
 <b>Back</b>	Return to the previous operation screen. <b>NOTE:</b> Only for the Embedded Player source.
 <b>Home</b>	Return to the Home Screen of the Embedded Player.
 <b>Backstage</b>	Display all embedded applications that are currently open.

Icon	Description
	<p>View all installed applications.</p>  <p>Browser      Chromium      Cloud Drive      myViewBoard Display</p> <p>Finder      Live      Miracast      myViewBoard Manager</p> <p>myViewBoard Whiteboard      Palette      PIP      Record</p> <p>Settings      Split-Screen      vCast</p>
 <p><b>All Apps</b></p>	<p><u>Browser</u> Web browser for surfing the Internet.</p>
	<p><u>Chromium</u> Web browser for surfing the Internet.</p>
	<p><u>Cloud Drive</u> Store and retrieve files from your cloud storage service.</p>
	<p><u>myViewBoard Display</u> Wirelessly mirror screens to a larger display.</p>
	<p><u>Finder</u> Manage files and folders.</p>
	<p><u>Live</u> Stream whiteboarding sessions.</p>
	<p><u>Miracast</u> Miracast wirelessly streams content from Windows and Android devices to a ViewBoard.</p>

Icon	Description
 <p data-bbox="204 853 338 891"><b>All Apps</b></p>	<p data-bbox="395 219 730 253"><u>myViewBoard Manager</u></p> <p data-bbox="395 266 1267 300">Remotely manage multiple installations of ViewSonic devices.</p>
	<p data-bbox="395 367 772 400"><u>myViewBoard Whiteboard</u></p> <p data-bbox="395 414 900 448">A digital whiteboarding application.</p>
	<p data-bbox="395 515 497 548"><u>Palette</u></p> <p data-bbox="395 562 1043 595">Select a color and adjust the saturation levels.</p>
	<p data-bbox="395 651 443 685"><u>PIP</u></p> <p data-bbox="395 698 1382 777">Picture-in-Picture. Split the screen into two parts, a main window and an inset window. Users can specify the input source for each screen.</p>
	<p data-bbox="395 819 497 853"><u>Record</u></p> <p data-bbox="395 866 991 900">Record, view, and save on-screen content.</p>
	<p data-bbox="395 967 512 1001"><u>Settings</u></p> <p data-bbox="395 1014 783 1048">Access the System Settings.</p>
	<p data-bbox="395 1115 564 1149"><u>Split-Screen</u></p> <p data-bbox="395 1162 1342 1196">Split the screen to display two different applications on the display.</p>
	<p data-bbox="395 1252 475 1285"><u>vCast</u></p> <p data-bbox="395 1299 1350 1413">Working with ViewBoard Cast software, receive vCastSender laptop screens (Windows/Mac/Chrome) and mobile (iOS/Android) users' screens, photos, videos, annotations, and camera(s).</p>
 <p data-bbox="225 1561 320 1594"><b>Menu</b></p>	<p data-bbox="395 1503 794 1536">Access the General Settings.</p>

Icon	Description
 <p data-bbox="229 456 316 495"><b>Mark</b></p>	<p data-bbox="395 203 1267 237">Annotate the overlay of any input source with a pen or brush.</p> 
 <p data-bbox="233 920 312 958"><b>Crop</b></p>	<p data-bbox="395 663 1110 696">Take a screenshot of the current screen and resize.</p> 

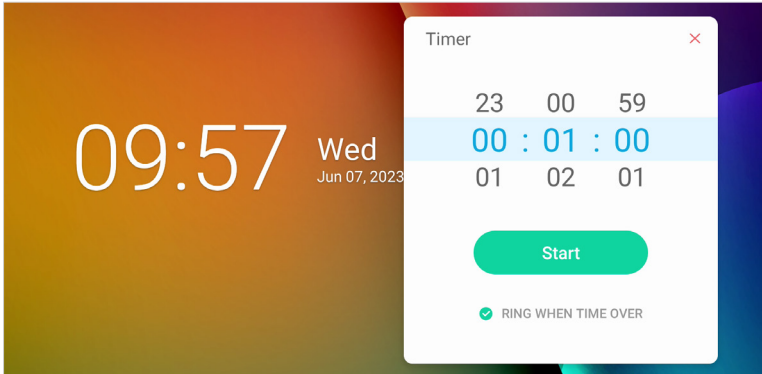
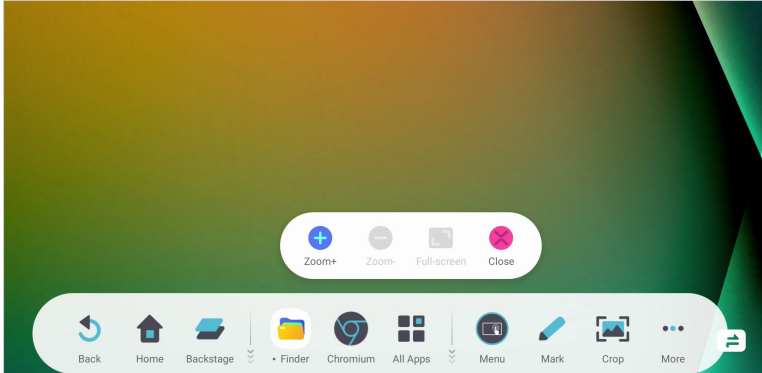
Icon	Description
	<p>View more applications within the toolbar.</p> <div style="display: flex; justify-content: space-around; text-align: center;"> <div> Timer</div> <div> Spotlight</div> <div> Record</div> <div> Freeze</div> </div> <div style="display: flex; justify-content: space-around; text-align: center; margin-top: 10px;"> <div> Split-Screen</div> <div> Screen Lock</div> <div> Calculator</div> </div>
<p>⋮</p> <p><b>More</b></p>	<p><u>Timer</u></p> <p>A countdown timer with an optional alarm setting. Touch and swipe to adjust the numeric values, then click Start. At any time, the countdown timer can be paused, resumed, or reset.</p> 
	<p><u>Spotlight</u></p> <p>Highlight the focus content zone. Tap the setting icon to adjust the spotlight size and alpha blending effect.</p>
	<p><u>Record</u></p> <p>Record, view, and save on-screen content.</p>
	<p><u>Freeze</u></p> <p>Convert the currently displayed content into a still image; then you can zoom in, zoom out, go back to full screen, and exit.</p> 

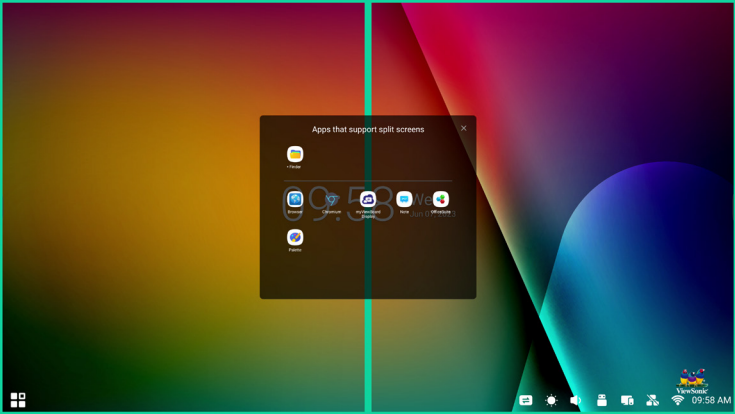
Icon	Description
<p style="text-align: center;">● ● ●</p> <p style="text-align: center;"><b>More</b></p>	<p><u>Split-Screen</u> Split the screen to display two different applications on the display.</p> 
	<p><u>Screen Lock</u> Lock the display's screen for added security.</p>
	<p><u>Calculator</u> Use for mathematical calculations.</p>



# Control Bar

Frequently used settings and tools can be accessed quickly through the Control Bar.

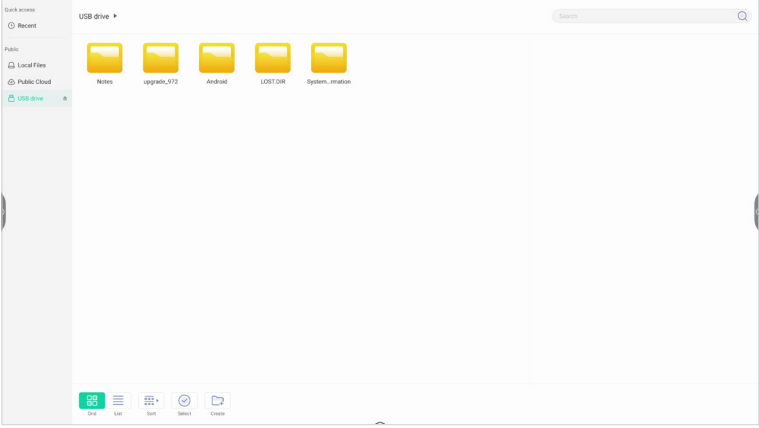
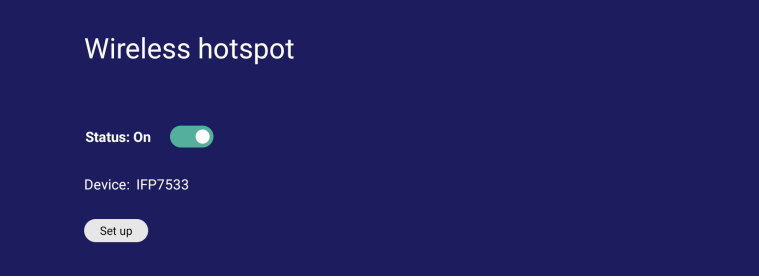
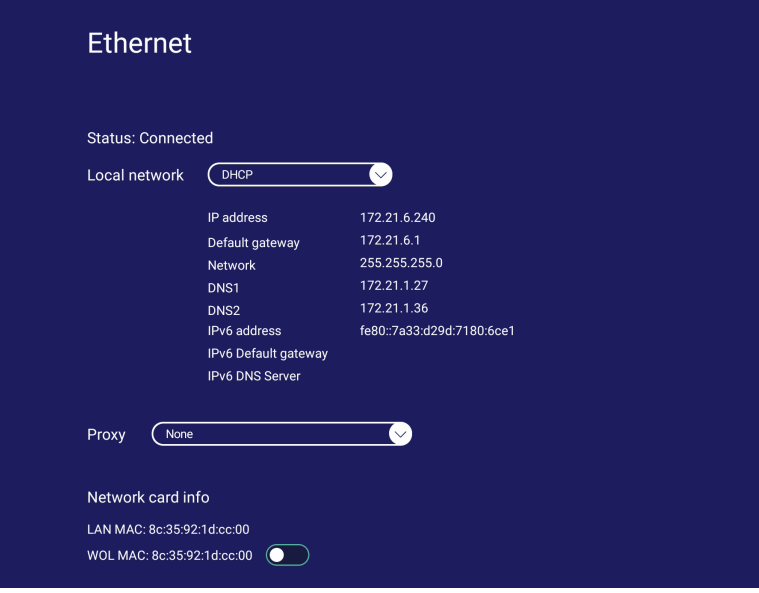

Item	Description
<p>1</p> <p><b>Input Source</b></p>	<p>Select the input source.</p> 
<p>2</p> <p><b>Brightness</b></p>	<p>Adjust the brightness level of the display.</p> 
<p>3</p> <p><b>Sound</b></p>	<p>Adjust the volume level of the display.</p> 

Item	Description
<p>4</p> <p>USB</p>	<p>If a USB storage device is connected, the USB icon will be visible. Clicking the icon will open the USB storage device's folder.</p> 
<p>5</p> <p>Hotspot</p>	<p>Shortcut to <b>Wireless Hotspot</b> settings. Enable or disable the hotspot function.</p> 
<p>6</p> <p>Ethernet</p>	<p>Shortcut to <b>Wireless &amp; Network LAN</b> settings. Enable or disable LAN connection.</p> 

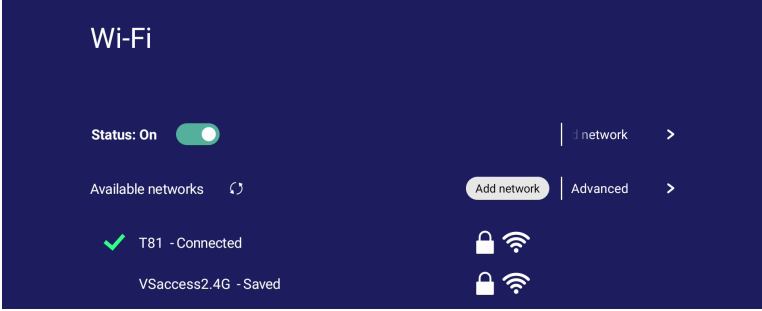
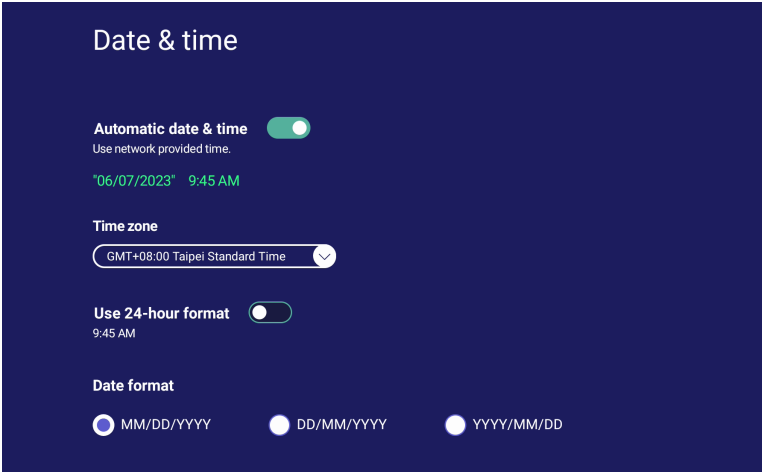
Item	Description
<p>7</p> <p><b>Wireless</b></p>	<p>Shortcut to <b>Wireless &amp; Network</b> Wi-Fi settings. Enable or disable Wi-Fi and connect to a wireless network.</p> 
<p>8</p> <p><b>Date &amp; Time</b></p>	<p>Shortcut to <b>Date &amp; Time</b> settings. Set the date and time of the display.</p> 

# On-Screen Display (OSD) Menu - General Settings

Access **Input**, **Display**, **Audio** and other general settings through the OSD Menu.

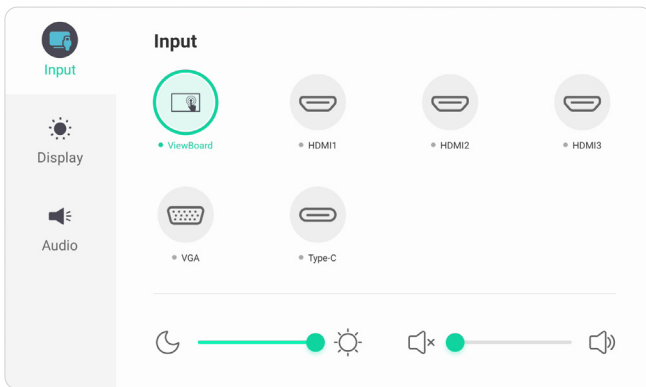

*Input Menu*

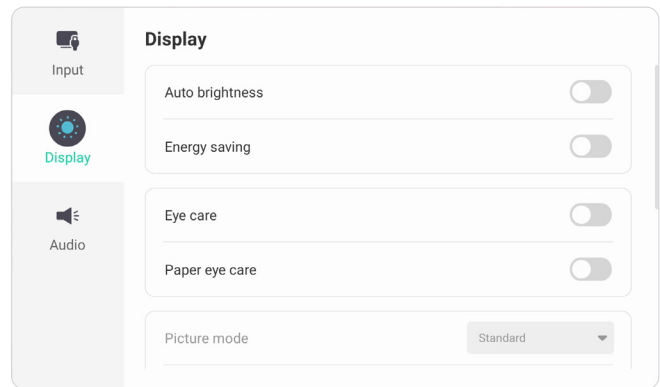

*Display Menu*

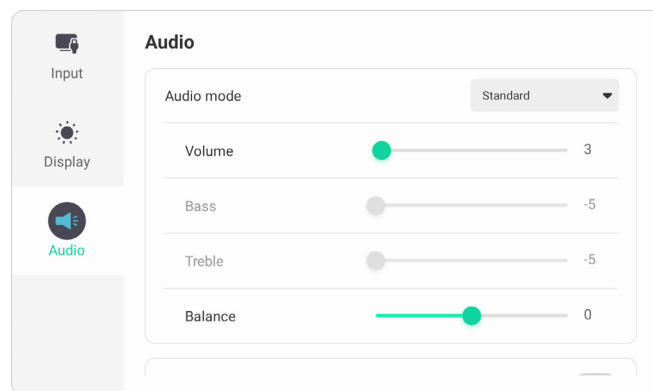

*Audio Menu*

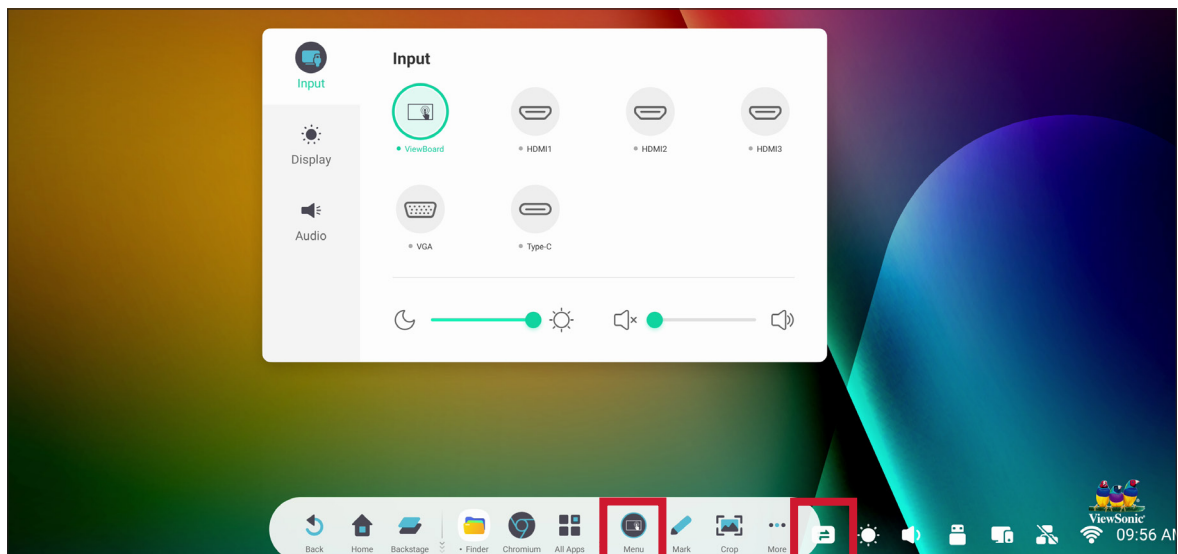

Open the OSD Menu by touching the **Menu** icon (  ) in the Toolbar or the **Input Source** icon (  ) of the Control Bar.

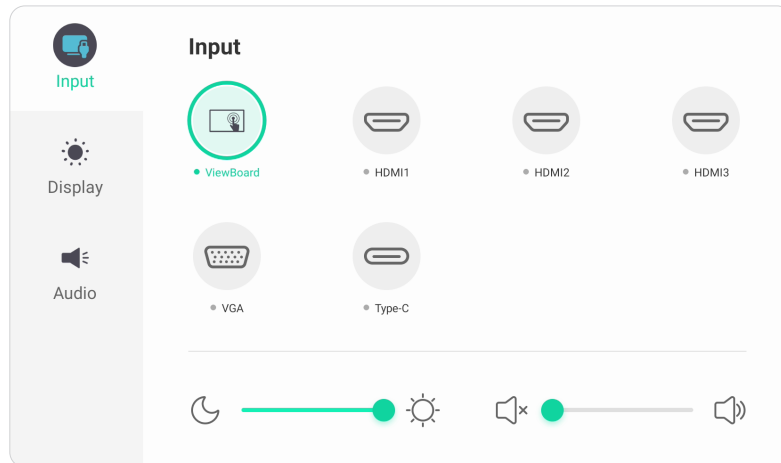

## Input Settings





To select an input source:

1. Press **INPUT** on the remote control or touch the **Menu** icon (  ) from the Toolbar or the **Input Source** icon (  ) of the Control Bar to display the **Input Settings** menu.
2. Press **▼/▲/◀/▶** on the remote control to select the input source you want.  
**NOTE:** The PC source will only be visible when a slot-in computer is installed.
3. Press **ENTER** on the remote control, or touch the input source.
4. Press **BACK** on the remote control, or touch a blank area outside of the menu to exit.



To adjust the brightness:

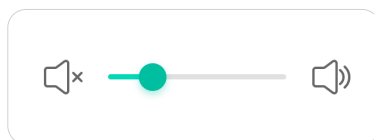

1. Press **INPUT** on the remote control or touch the **Menu** icon (  ) from the Toolbar or the **Input Source** icon (  ) of the Control Bar to display the **Input Settings** menu.
2. Touch and drag the brightness slider directly to adjust the backlight value.
3. Press **BACK** on the remote control, or touch a blank area outside of the menu to exit.

To adjust the volume:



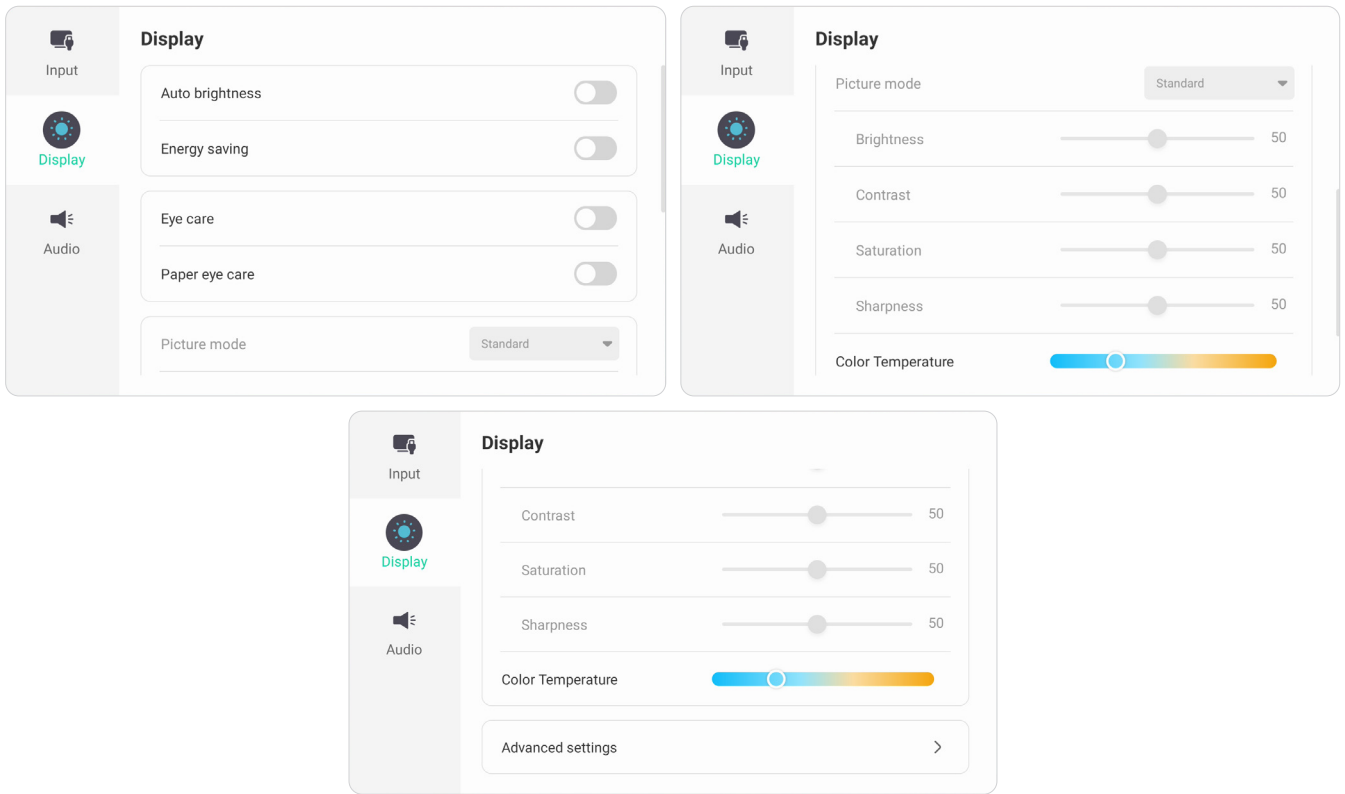

1. Press **INPUT** on the remote control or touch the **Menu** icon (  ) from the Toolbar or the **Input Source** icon (  ) of the Control Bar to display the **Input Settings** menu.
2. Touch and drag the volume slider directly to adjust the value, or press **VOL +/VOL -** on the remote control to adjust. Additionally, pressing **Mute** (  ) on the remote control will mute/unmute the volume.
3. Press **BACK** on the remote control, or touch a blank area outside of the menu to exit.

# Display Settings



To adjust the display settings:

1. Press **INPUT** on the remote control or touch the **Menu** icon (  ) from the Toolbar or the **Input Source** icon (  ) of the Control Bar to display the **Input Settings** menu. Then select the **Display** tab.
2. Press **▼/▲/◀/▶** on the remote control to select the menu option you want.
3. Press **ENTER** on the remote control to confirm or press **◀/▶** to adjust the menu option. Additionally, touch/adjust the menu option directly.
4. Press **BACK** on the remote control, or touch a blank area outside of the menu to exit.

## Display Settings - Menu Options

Item	Description										
<b>Auto Brightness</b>	Automatic brightness adjustment. Adjusts maximum brightness according to ambient light levels.										
<b>Energy Saving</b>	Enable to reduce power consumption.										
<b>Eye Care</b>	Adjusts the filter that blocks high-energy blue light for a more comfortable viewing experience.										
<b>Paper Eye Care</b>	When “Low Blue Light” is enabled, adjust the Transparency to lower the brightness and warm the color temperature.										
<b>Picture Mode</b>	Select a predefined picture setting.										
	<table border="1"> <thead> <tr> <th>Mode</th> <th>Description</th> </tr> </thead> <tbody> <tr> <td><b>Standard</b></td> <td>Default picture mode.</td> </tr> <tr> <td><b>Bright</b></td> <td>Maximizes the brightness of the display. This mode is suitable for environments where extra-high brightness is required (e.g., well-lit rooms).</td> </tr> <tr> <td><b>Soft</b></td> <td>A high brightness level with lower contrast level.</td> </tr> <tr> <td><b>Custom</b></td> <td>Customize the picture settings.</td> </tr> </tbody> </table>	Mode	Description	<b>Standard</b>	Default picture mode.	<b>Bright</b>	Maximizes the brightness of the display. This mode is suitable for environments where extra-high brightness is required (e.g., well-lit rooms).	<b>Soft</b>	A high brightness level with lower contrast level.	<b>Custom</b>	Customize the picture settings.
	Mode	Description									
	<b>Standard</b>	Default picture mode.									
	<b>Bright</b>	Maximizes the brightness of the display. This mode is suitable for environments where extra-high brightness is required (e.g., well-lit rooms).									
<b>Soft</b>	A high brightness level with lower contrast level.										
<b>Custom</b>	Customize the picture settings.										
<b>Brightness</b>	Adjusts background black levels of the screen image. The higher the value, the brighter the image. Lower values will result in a darker image.										
<b>Contrast</b>	Adjusts the difference between the image background (black level) and the foreground (white level). Use this to set the peak white level after you have previously adjusted the <b>Brightness</b> setting to suit your selected input and viewing environment.										
<b>Saturation</b>	The amount of color in a picture. Lower settings produce less saturated colors; in fact, a setting of “0” removes that color from the image entirely. If the saturation is too high though, that color will be overpowering and unrealistic.										
<b>Sharpness</b>	A high value results in a sharper picture; a low value softens the picture.										
<b>Color Temperature</b>	Adjust the color temperature value.										



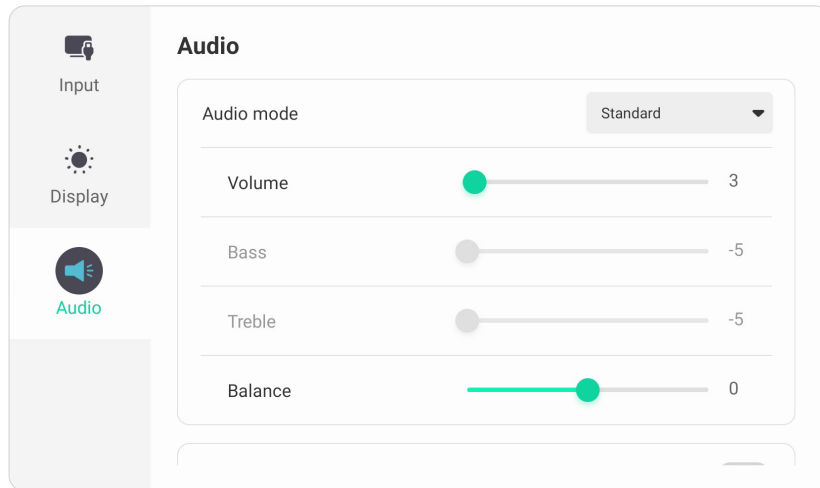

Item	Description														
<b>Advanced Settings</b>	<p><u>Color Space</u> Choose the color space to use for color output.</p> <table border="1" data-bbox="480 293 1401 824"> <thead> <tr> <th data-bbox="480 293 692 342">Mode</th> <th data-bbox="692 293 1401 342">Description</th> </tr> </thead> <tbody> <tr> <td data-bbox="480 342 692 392"><b>Standard</b></td> <td data-bbox="692 342 1401 392">Default color space standard.</td> </tr> <tr> <td data-bbox="480 392 692 477"><b>sRGB</b></td> <td data-bbox="692 392 1401 477">Precise color gamut and gamma of the sRGB standard.</td> </tr> <tr> <td data-bbox="480 477 692 562"><b>AdobeRGB</b></td> <td data-bbox="692 477 1401 562">Precise color gamut and gamma of the Adobe RGB standard.</td> </tr> <tr> <td data-bbox="480 562 692 647"><b>Display-P3</b></td> <td data-bbox="692 562 1401 647">Precise color gamut and gamma of the Display-P3 standard.</td> </tr> <tr> <td data-bbox="480 647 692 732"><b>DCI-P3</b></td> <td data-bbox="692 647 1401 732">Precise color gamut and gamma of the DCI-P3 standard.</td> </tr> <tr> <td data-bbox="480 732 692 824"><b>BT2020</b></td> <td data-bbox="692 732 1401 824">Precise color gamut and gamma of the BT2020 standard.</td> </tr> </tbody> </table>	Mode	Description	<b>Standard</b>	Default color space standard.	<b>sRGB</b>	Precise color gamut and gamma of the sRGB standard.	<b>AdobeRGB</b>	Precise color gamut and gamma of the Adobe RGB standard.	<b>Display-P3</b>	Precise color gamut and gamma of the Display-P3 standard.	<b>DCI-P3</b>	Precise color gamut and gamma of the DCI-P3 standard.	<b>BT2020</b>	Precise color gamut and gamma of the BT2020 standard.
	Mode	Description													
	<b>Standard</b>	Default color space standard.													
	<b>sRGB</b>	Precise color gamut and gamma of the sRGB standard.													
	<b>AdobeRGB</b>	Precise color gamut and gamma of the Adobe RGB standard.													
	<b>Display-P3</b>	Precise color gamut and gamma of the Display-P3 standard.													
	<b>DCI-P3</b>	Precise color gamut and gamma of the DCI-P3 standard.													
	<b>BT2020</b>	Precise color gamut and gamma of the BT2020 standard.													
	<p><u>HDMI Range</u> Select a suitable color range according to the color range setting of the connected output device.</p> <table border="1" data-bbox="480 994 1401 1191"> <thead> <tr> <th data-bbox="480 994 692 1043">Mode</th> <th data-bbox="692 994 1401 1043">Description</th> </tr> </thead> <tbody> <tr> <td data-bbox="480 1043 692 1093"><b>Auto</b></td> <td data-bbox="692 1043 1401 1093">Detect the range of the input signal automatically.</td> </tr> <tr> <td data-bbox="480 1093 692 1142"><b>Full</b></td> <td data-bbox="692 1093 1401 1142">Sets the color range from 0~255</td> </tr> <tr> <td data-bbox="480 1142 692 1191"><b>Limited</b></td> <td data-bbox="692 1142 1401 1191">Sets the color range from 16~235</td> </tr> </tbody> </table>	Mode	Description	<b>Auto</b>	Detect the range of the input signal automatically.	<b>Full</b>	Sets the color range from 0~255	<b>Limited</b>	Sets the color range from 16~235						
	Mode	Description													
<b>Auto</b>	Detect the range of the input signal automatically.														
<b>Full</b>	Sets the color range from 0~255														
<b>Limited</b>	Sets the color range from 16~235														
<p><u>Pixel Shift</u> Reduce the possibility of screen burn-in. This setting allows the user to program the time between movements of the picture in minutes.</p>															
<p><u>AI PQ</u> Automatically set the optimal resolution of the display.</p>															
<p><u>Dynamic Backlight (DCR)</u> Automatically detects the image signal and intelligently controls the backlight brightness and color to improve on the ability to make the black blacker in a dark scene, and make the white whiter in a bright environment.</p>															

## Audio Settings



To adjust the display settings:

1. Press **INPUT** on the remote control or touch the **Menu** icon (  ) from the Toolbar or the **Input Source** icon (  ) of the Control Bar to display the **Input Settings** menu. Then select the **Audio** tab.
2. Press **▼/▲/◀/▶** on the remote control to select the menu option you want.
3. Press **ENTER** on the remote control to confirm or press **◀/▶** to adjust the menu option. Additionally, touch/adjust the menu option directly.
4. Press **BACK** on the remote control, or touch a blank area outside of the menu to exit.

## Audio Settings - Menu Options

Item	Description										
<b>Audio Mode</b>	Select a predefined audio setting.										
	<table border="1"> <thead> <tr> <th data-bbox="480 304 691 360">Mode</th> <th data-bbox="691 304 1401 360">Description</th> </tr> </thead> <tbody> <tr> <td data-bbox="480 360 691 409"> <b>Standard</b> </td> <td data-bbox="691 360 1401 409">           Default audio mode.         </td> </tr> <tr> <td data-bbox="480 409 691 459"> <b>Meeting</b> </td> <td data-bbox="691 409 1401 459">           Ideal for meetings. Higher bass, lower treble levels.         </td> </tr> <tr> <td data-bbox="480 459 691 508"> <b>Class</b> </td> <td data-bbox="691 459 1401 508">           Ideal for the classroom. Low bass and treble levels.         </td> </tr> <tr> <td data-bbox="480 508 691 560"> <b>Custom</b> </td> <td data-bbox="691 508 1401 560">           Customize the audio settings.         </td> </tr> </tbody> </table>	Mode	Description	<b>Standard</b>	Default audio mode.	<b>Meeting</b>	Ideal for meetings. Higher bass, lower treble levels.	<b>Class</b>	Ideal for the classroom. Low bass and treble levels.	<b>Custom</b>	Customize the audio settings.
	Mode	Description									
	<b>Standard</b>	Default audio mode.									
	<b>Meeting</b>	Ideal for meetings. Higher bass, lower treble levels.									
<b>Class</b>	Ideal for the classroom. Low bass and treble levels.										
<b>Custom</b>	Customize the audio settings.										
<b>Volume</b>	Increase or decrease the display's volume level.										
<b>Bass</b>	Increase or decrease the bass level (lower-pitched sounds).										
<b>Treble</b>	Increase or decrease the treble level (higher-pitched sounds).										
<b>Balance</b>	Adjust the left/right speaker balance.										
<b>Mute</b>	Toggle mute On or Off.										

## Low Blue Light Filter and Eye Health

The Blue Light Filter blocks high-energy blue light for a more comfortable viewing experience.

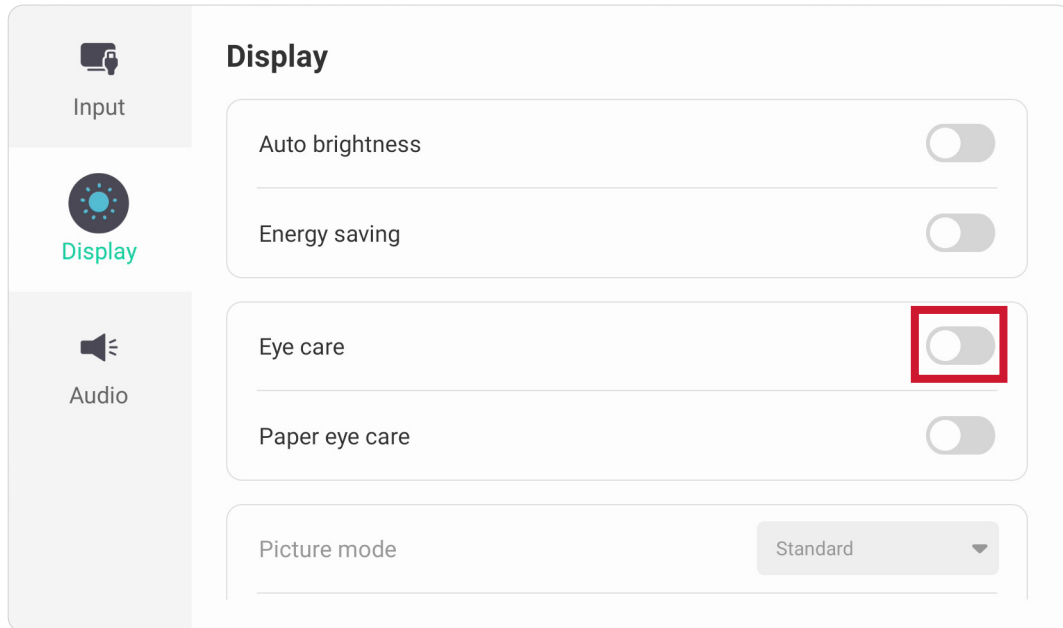

### Calculating Breaks

When viewing screens for extended periods, it is recommended to take periodic breaks from viewing. Short breaks of at least 10 minutes are recommended after one (1) hour of continuous viewing.

Taking shorter, more frequent breaks are generally more beneficial than longer, less frequent breaks.

### Focus Fatigue (20-20-20 Rule)

To reduce the risk of eye fatigue by constantly looking at the screen, look away from the screen at least every 20 minutes and gaze at a distant object (at least 20 feet away) for at least 20 seconds.

### Looking at Distant Objects

While taking breaks, users can further reduce eye strain and dryness by focusing on objects that are further away from them for 10-15 seconds, then gaze at something up close for 10-15 seconds. Repeat this up to 10 times. This exercise reduces the risk of your eyes' focusing ability to "lock up" after prolonged computer work.

## Eye and Neck Exercises

### Eye Exercises

Eye exercises can help minimize eye strain. Slowly roll your eyes to the left, right, up, and down. Repeat as many times as needed.

#### Exercises for the eyes

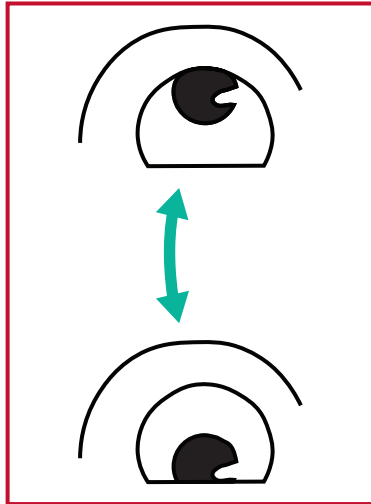

(1) Keep the body and the head upright. Move the eyes up to look at the ceiling, then turn down to look at the floor.

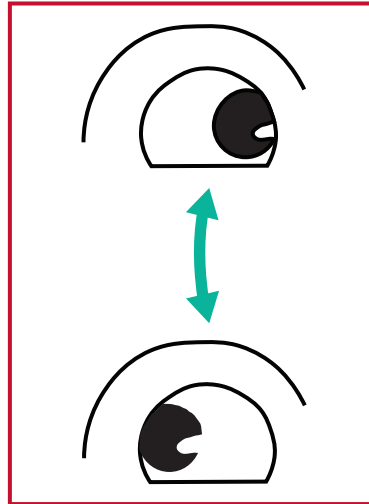

(2) Move the eyes left and right slowly to look at objects on the two sides.

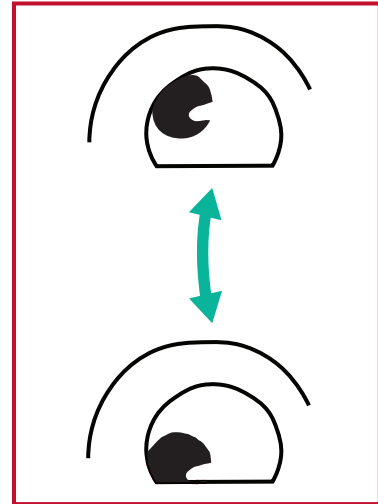

(3) Move the eyes to look at objects at the right upper direction and then right lower direction. Repeat for the left upper and left lower directions.

### Neck Exercises

Neck exercises can also help minimize eye strain. Relax your arms and let them hang at your sides, bend forward slightly to stretch the neck, turn your head to the right and to the left. Repeat as many times as needed.

## Settings - ViewBoard Input Source

The ViewBoard input source is the default source that is active when turning on the ViewBoard. Press **MENU** (☰) on the remote control or tap the setting icon (⚙️) next to the input source in the On-Screen Display (OSD) Menu's Input Settings to enter the **Settings** menu.

### Network & Internet

Check current network connection status, set up and manage Wi-Fi, Ethernet, Bluetooth, and VPN, and establish a Wireless hotspot.

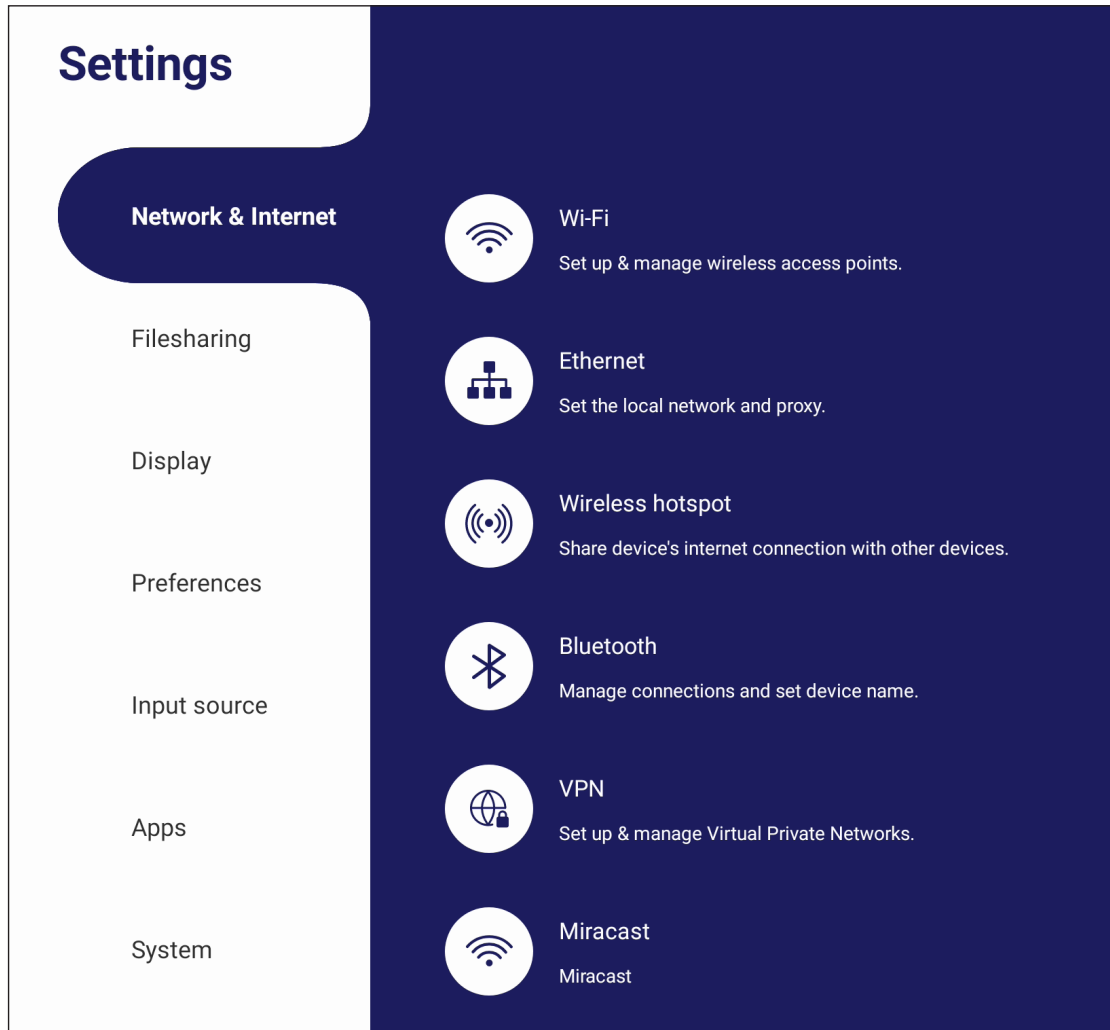

#### NOTE:

- Wi-Fi, Wireless Hotspot, and Bluetooth settings will appear when an optional Wi-Fi card (e.g., VB-WIFI-004) has been installed in the Wi-Fi slot.
- Ethernet will disable automatically when Wi-Fi is enabled. Wi-Fi will disable automatically when Ethernet is enabled. Wi-Fi will disable when Hotspot is enabled.
- The device cannot connect to the Internet when Wireless Hotspot is enabled.

## Wi-Fi

Setup and manage wireless access points.

- Tap the toggle button to turn Wi-Fi **On** or **Off**.

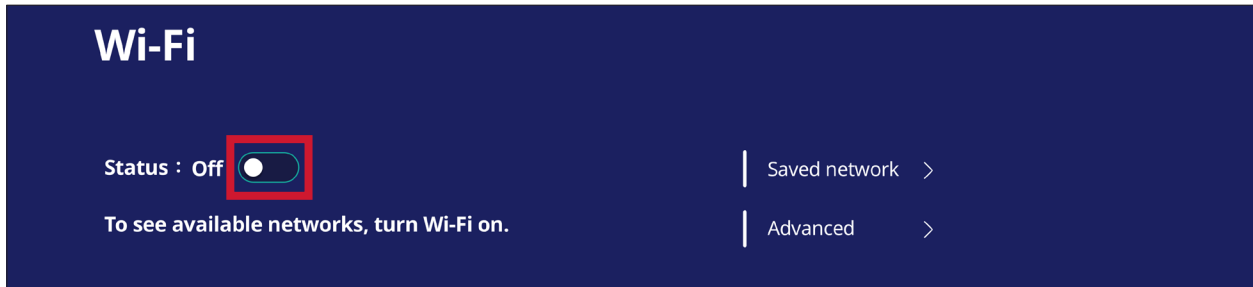

- Once **On**, you can: **Add a Network**, view **Saved Networks**, **Refresh** the network list, or view **Advanced** settings.

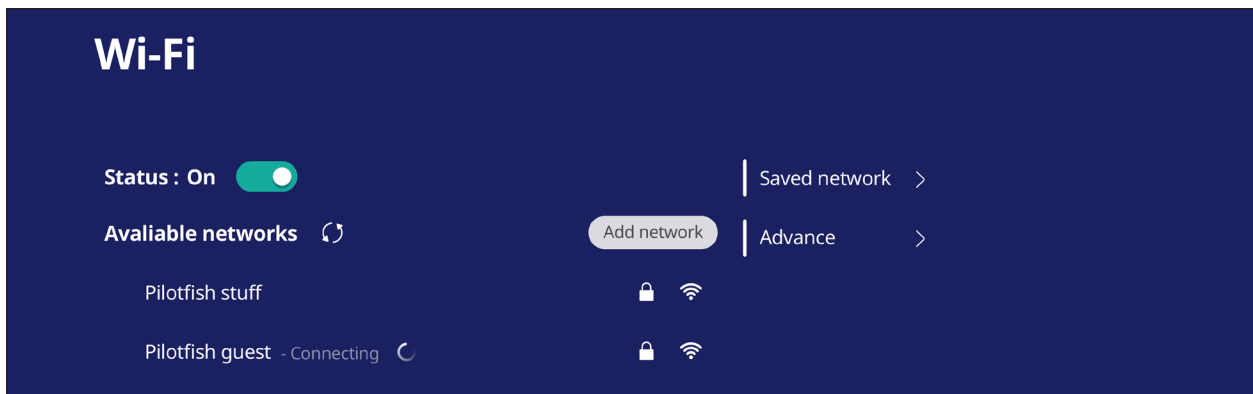

- In **Advanced** settings, you can toggle **Network notifications On** or **Off** and view **Network card info**.

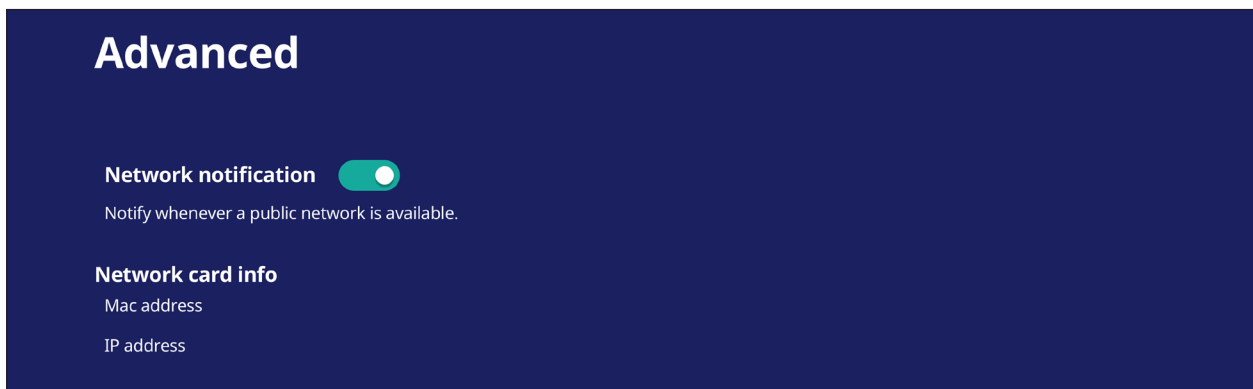

## Ethernet

Set the local network and proxy.

- Tap the drop down menu to connect/disconnect the Ethernet.

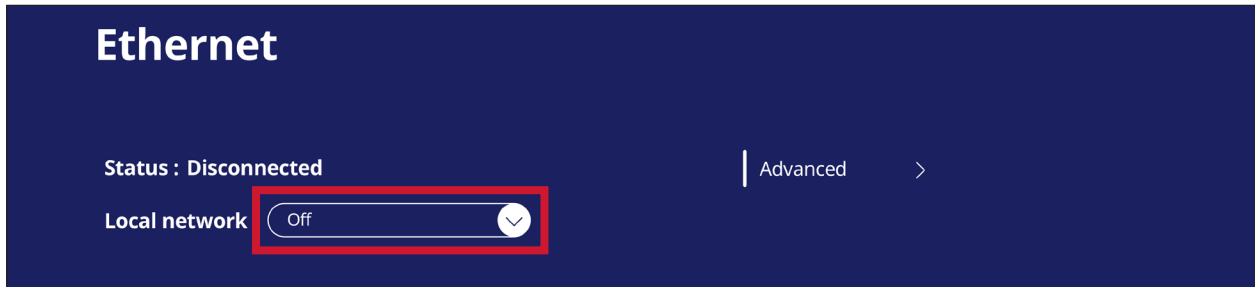

- You can adjust **Local network** and **Proxy** settings as well.

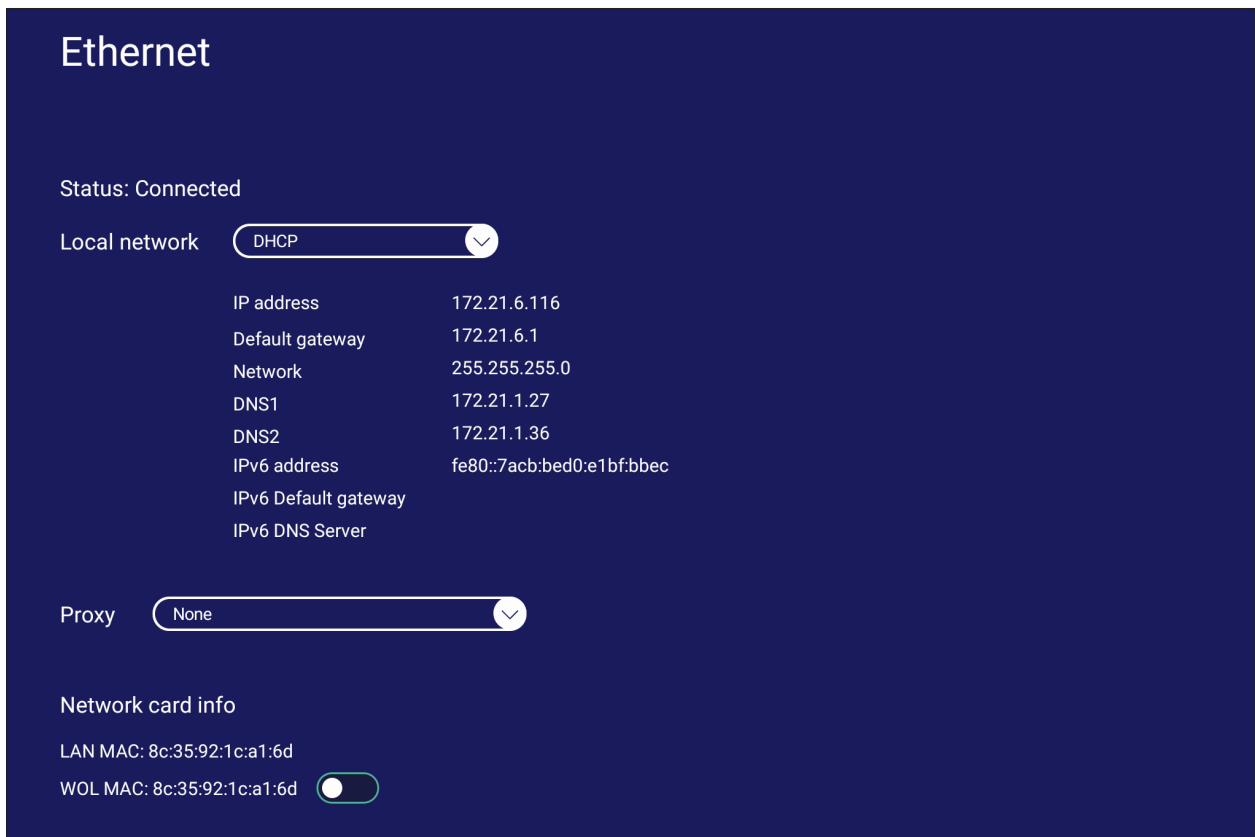



## Wireless Hotspot

Set and share my internet connection with other devices.

- Tap the toggle button to turn **Wireless hotspot On** or **Off**.

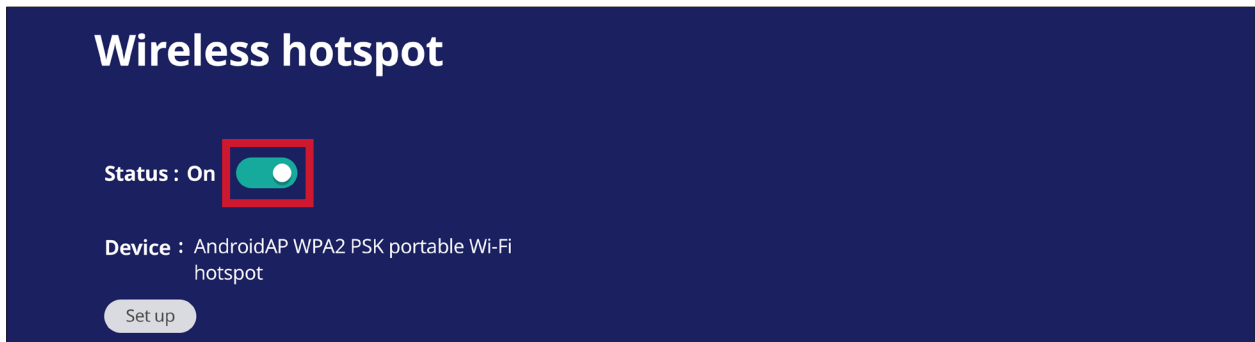

- Tap **Set up** to set the **Network name**, **Security**, and **Password**.

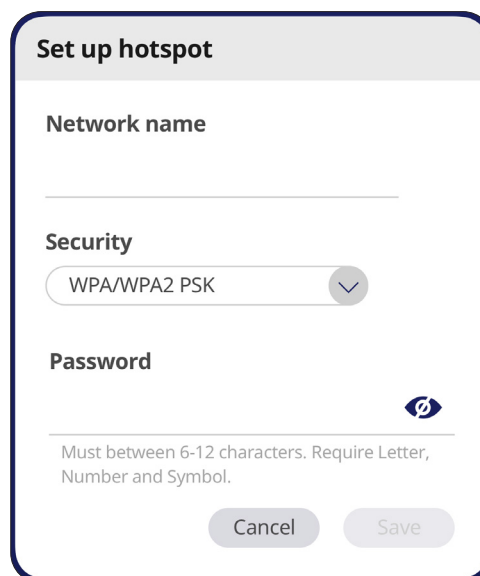
A screenshot of the 'Set up hotspot' dialog box. It has a title bar 'Set up hotspot'. Below the title bar, there are three sections: 'Network name' with an empty text input field; 'Security' with a dropdown menu showing 'WPA/WPA2 PSK'; and 'Password' with an empty text input field and a toggle icon for visibility. Below the password field, there is a note: 'Must between 6-12 characters. Require Letter, Number and Symbol.' At the bottom, there are 'Cancel' and 'Save' buttons.

## Bluetooth

Manage connections, set the device name and discoverability.

- Tap the toggle button to turn Bluetooth **On** or **Off**. Once **On**, users can select a listed device to pair and connect to, rename their device, remove a device, or receive files.

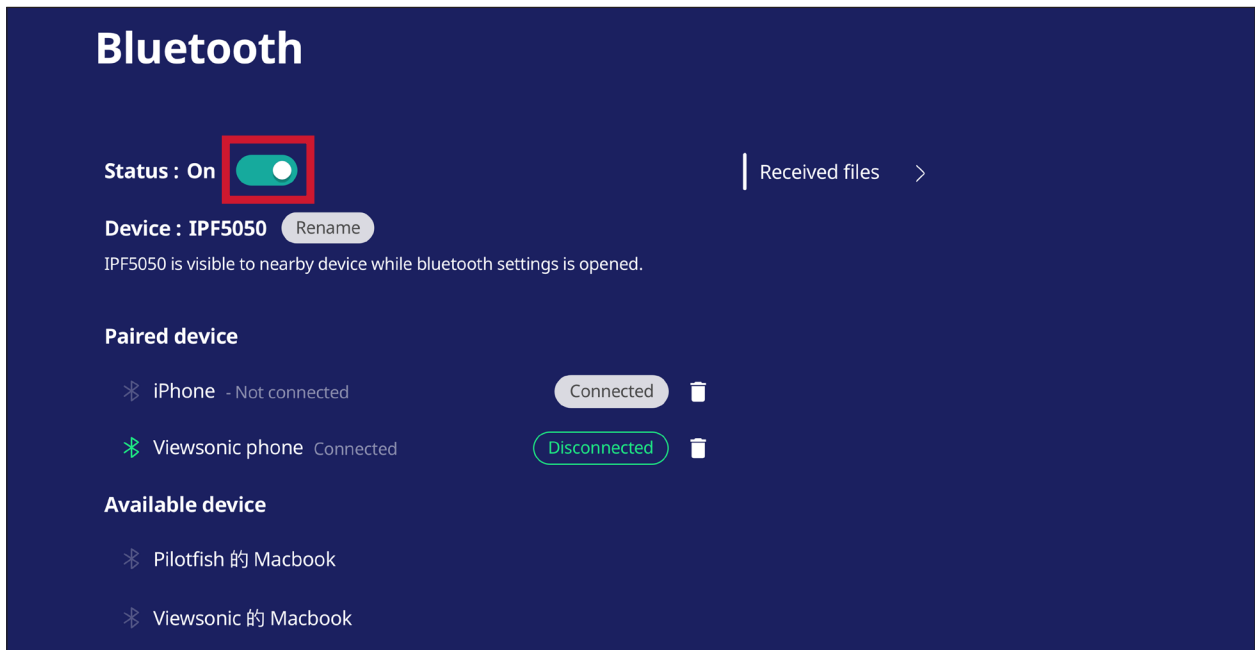

- Tap **Received files** to show all received files.

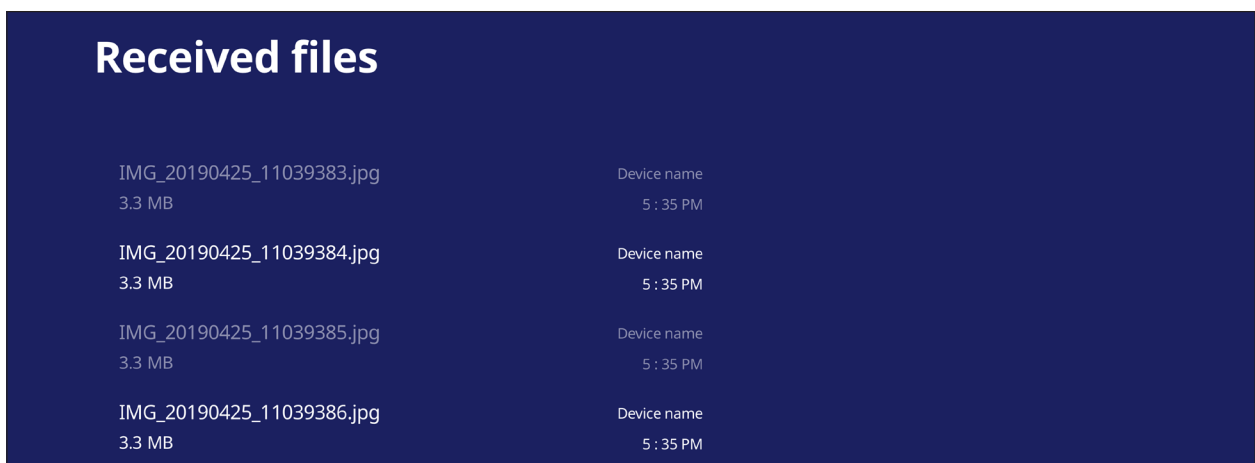

## VPN

Setup and manage Virtual Private Networks.

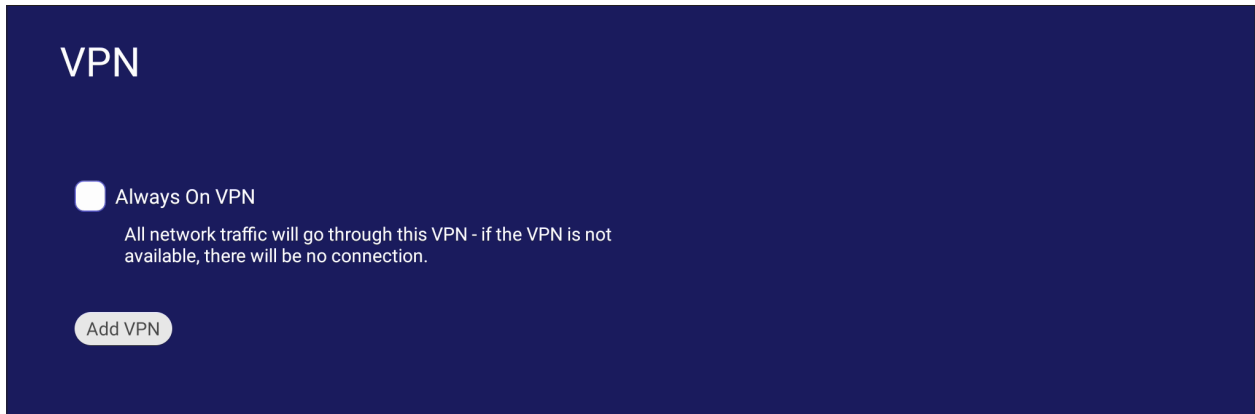

To create a VPN profile:

1. Go to: **Settings > Network & Internet > VPN** and tap **Add VPN**.

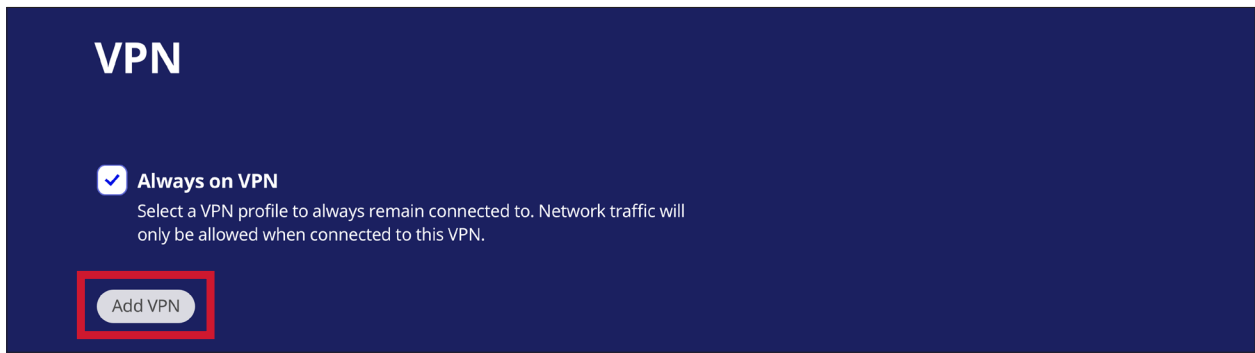

2. Key in the **Name**.

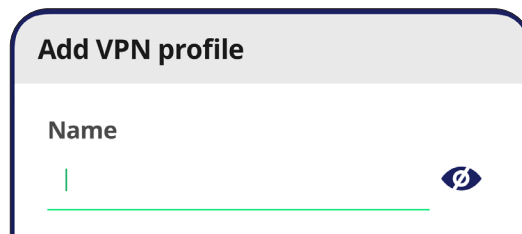

### 3. Select the VPN Type.

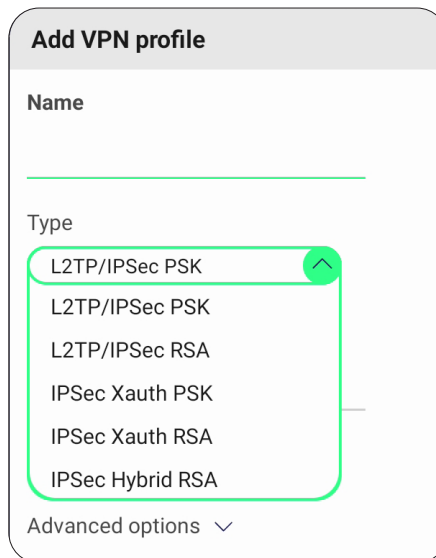

The screenshot shows the 'Add VPN profile' dialog box. The 'Name' field is empty. The 'Type' dropdown menu is open, showing a list of options: 'L2TP/IPSec PSK' (highlighted with a green border and an upward arrow), 'L2TP/IPSec PSK', 'L2TP/IPSec RSA', 'IPSec Xauth PSK', 'IPSec Xauth RSA', and 'IPSec Hybrid RSA'. Below the dropdown is an 'Advanced options' section with a downward arrow.

### 4. Choose to enable/disable PPP encryption (MPPE) and/or show Advanced options.

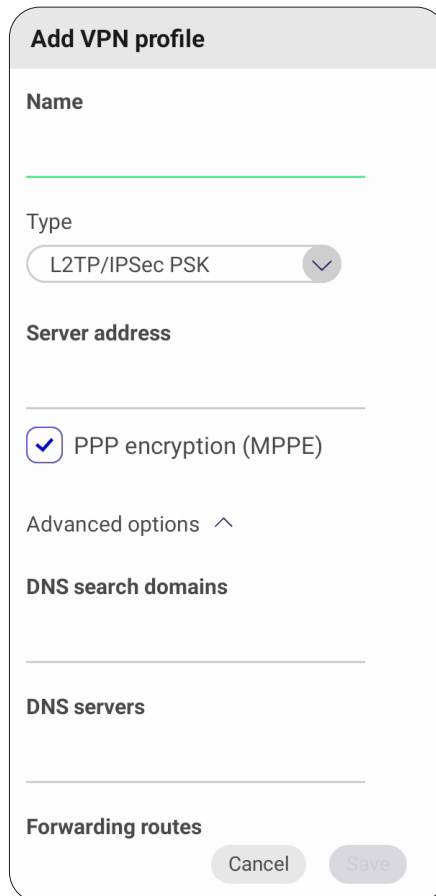

The screenshot shows the 'Add VPN profile' dialog box. The 'Name' field is empty. The 'Type' dropdown menu is closed, showing 'L2TP/IPSec PSK'. The 'Server address' field is empty. The 'PPP encryption (MPPE)' checkbox is checked. Below it is an 'Advanced options' section with an upward arrow. The 'DNS search domains' and 'DNS servers' fields are empty. The 'Forwarding routes' section is empty. At the bottom right are 'Cancel' and 'Save' buttons.

## Miracast

Enable/disable Miracast. Miracast allows for wireless sharing of multimedia and screens of connected devices.



## File Sharing

### SAMBA

The SAMBA Service provides file sharing via LAN. When the SAMBA Service is enabled, the user can explore the ViewBoard file system with a PC or mobile equipment.

1. Go to: **Settings > File Sharing > SAMBA.**

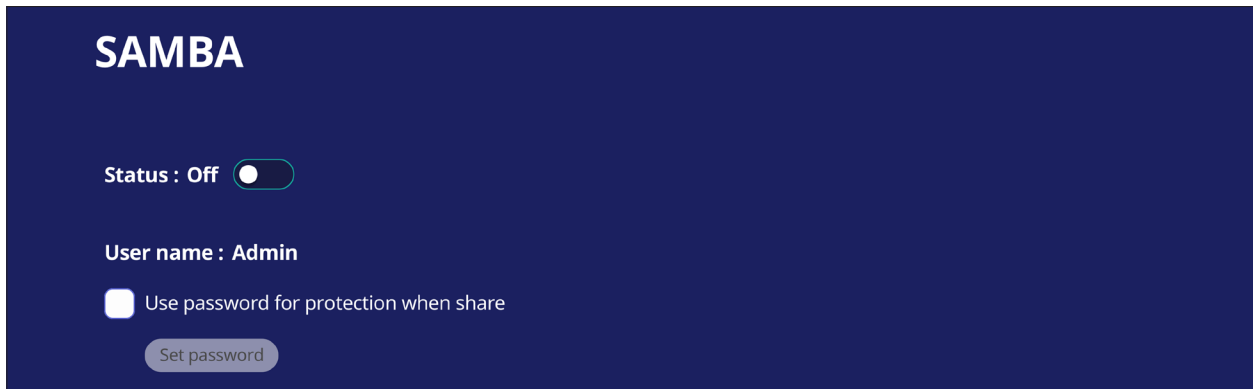

2. Tap the toggle button to enable the SAMBA Service, then set a password if needed.

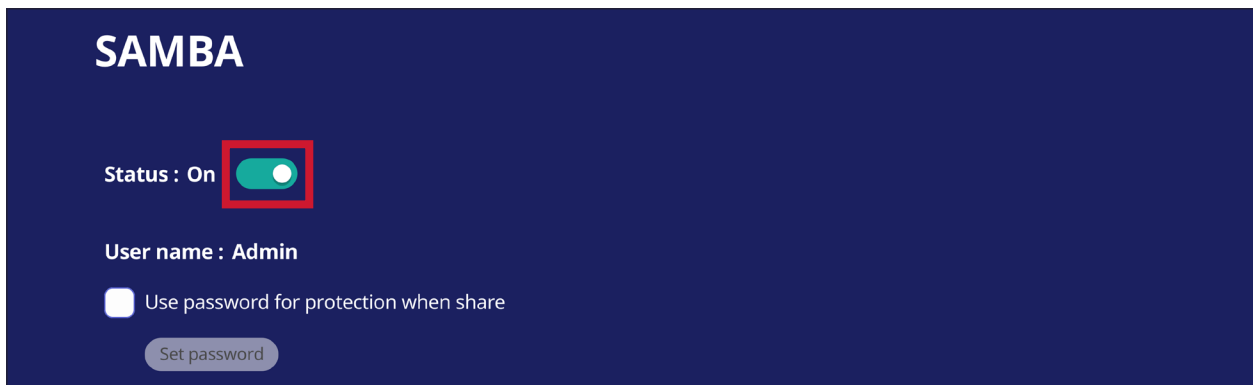

3. Ensure the ViewBoard and client equipment are connected to the same network.
4. Log in to the ViewBoard with the client equipment. Input the ViewBoard's IP address.

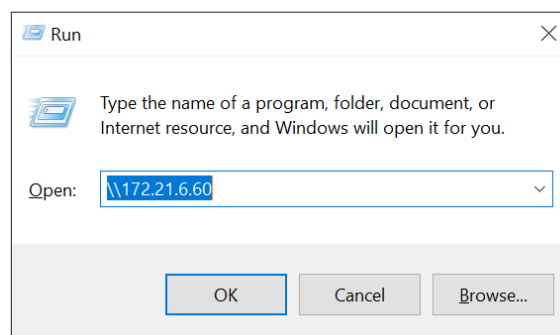

5. Key in the user name and password, then select **OK** (if applicable).

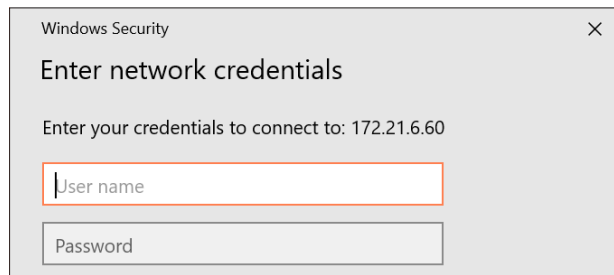

6. After a successful log in, the ViewBoard files will be available.

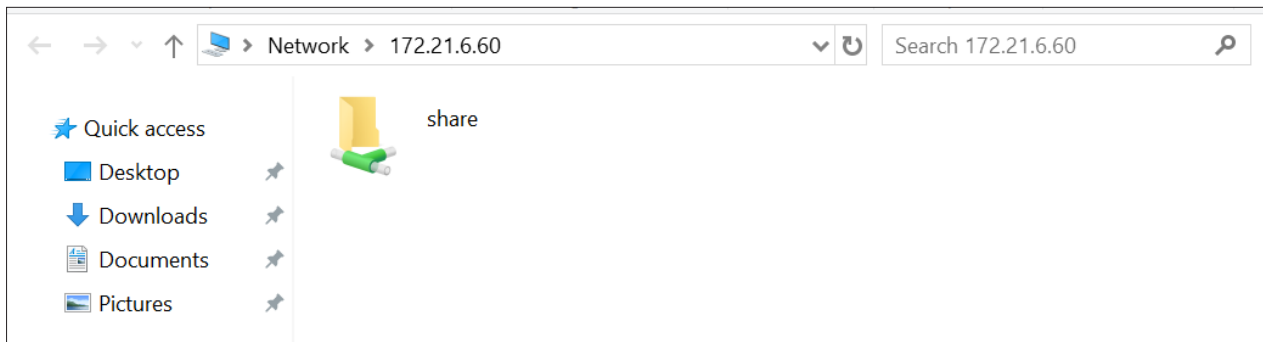

## Display

Adjust the Wallpaper, Theme, Display ID, Protection, and HDMI Out settings.

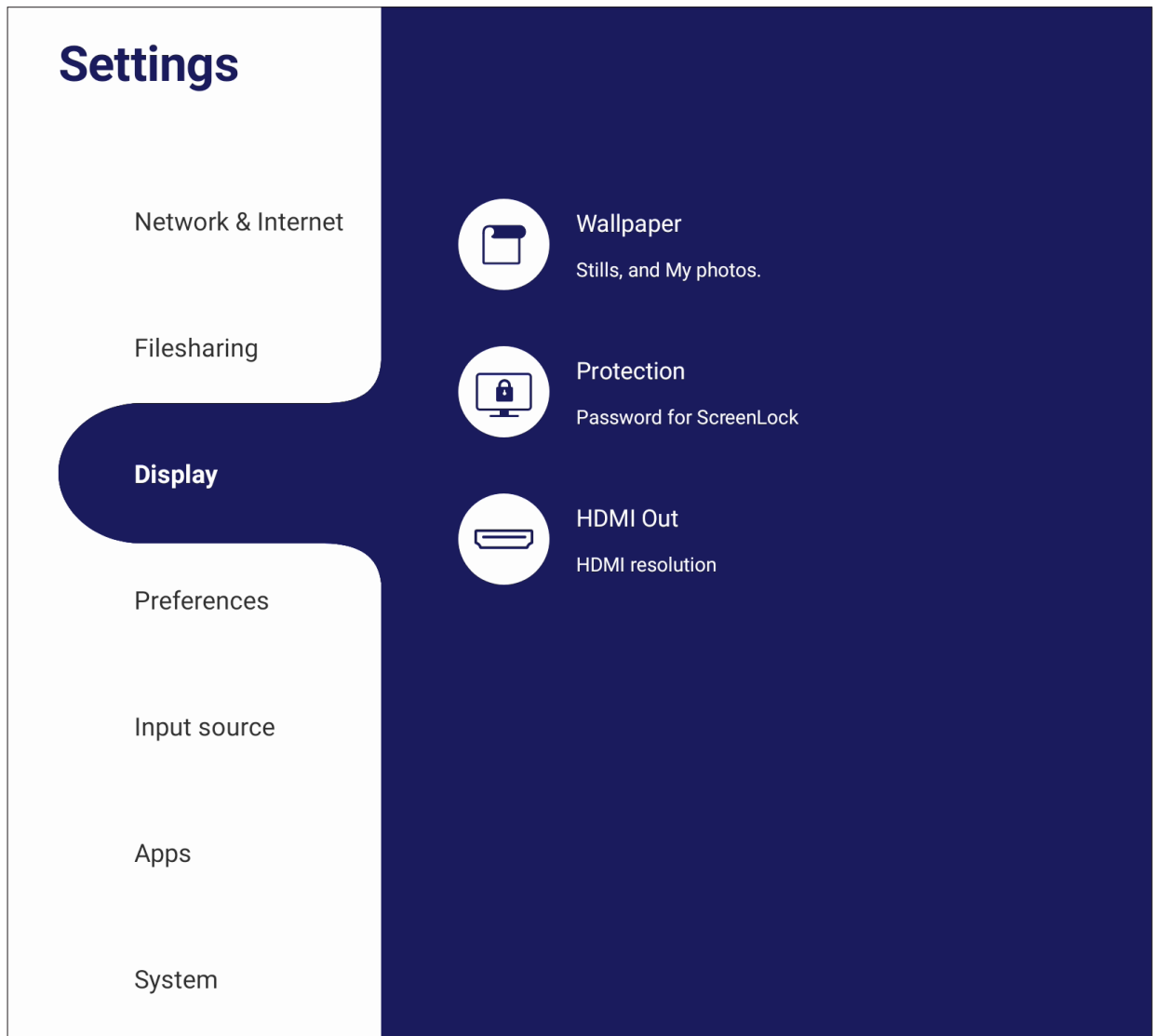



## Wallpaper

Users can change their wallpaper with default images (both still and live), or use their own by tapping **My Photo** and selecting the image file.

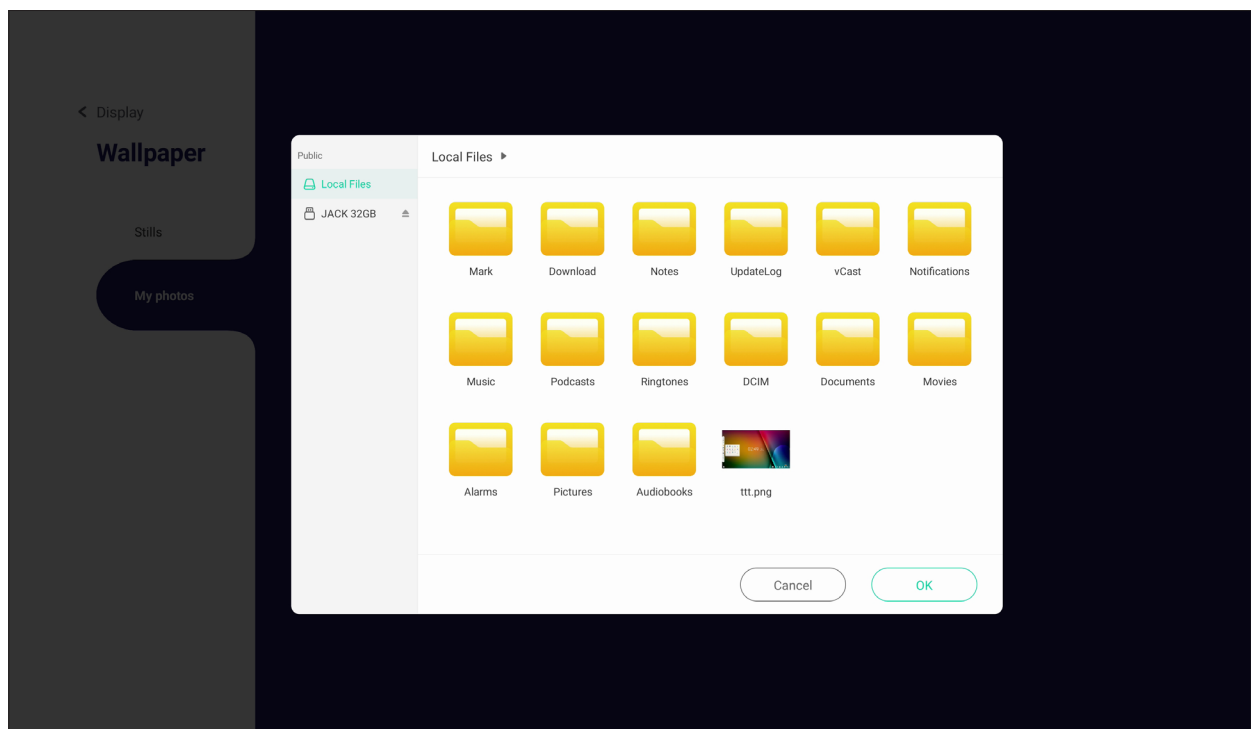

## Protection

Toggle **HDCP & Copyright** On/Off, and set a **Password for Screen Lock**.

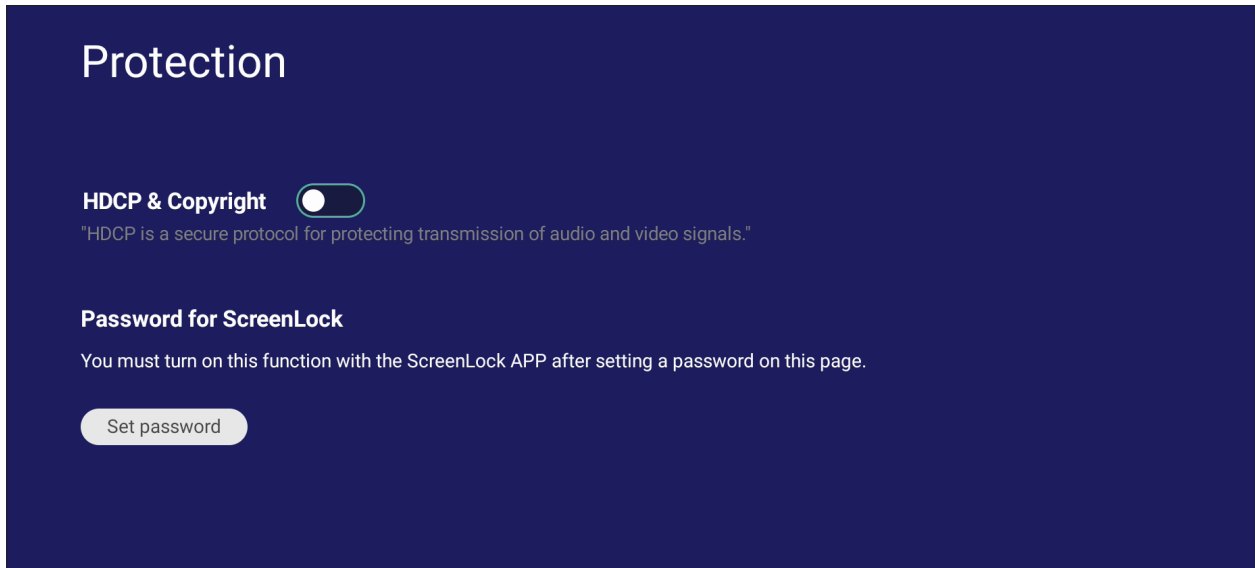

- To set up a password for screen lock, tap **Set Password** and enter the desired password.

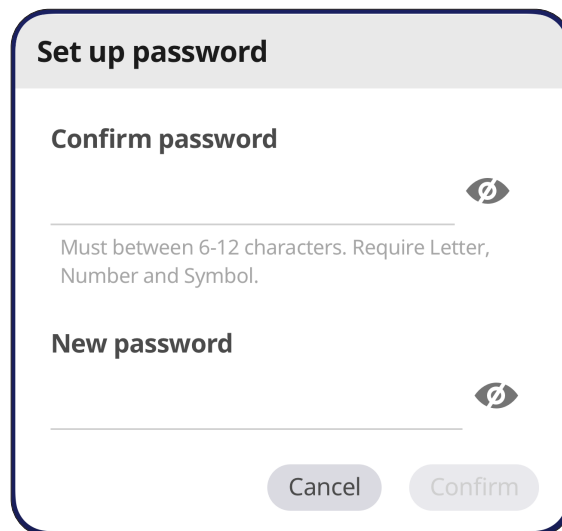
A screenshot of a 'Set up password' dialog box. The dialog has a light gray header with the title 'Set up password'. Below the header, there are two input fields. The first is labeled 'Confirm password' and has a small eye icon to its right. Below this field, a small gray text reads: 'Must between 6-12 characters. Require Letter, Number and Symbol.' The second input field is labeled 'New password' and also has a small eye icon to its right. At the bottom of the dialog, there are two buttons: 'Cancel' and 'Confirm'.

## HDMI Out

Adjust the HDMI Out Resolution setting, enable video output, and mute/unmute the display speaker when connected via HDMI Out.

**NOTE:** The disable ViewBoard speakers option box is unchecked by default.

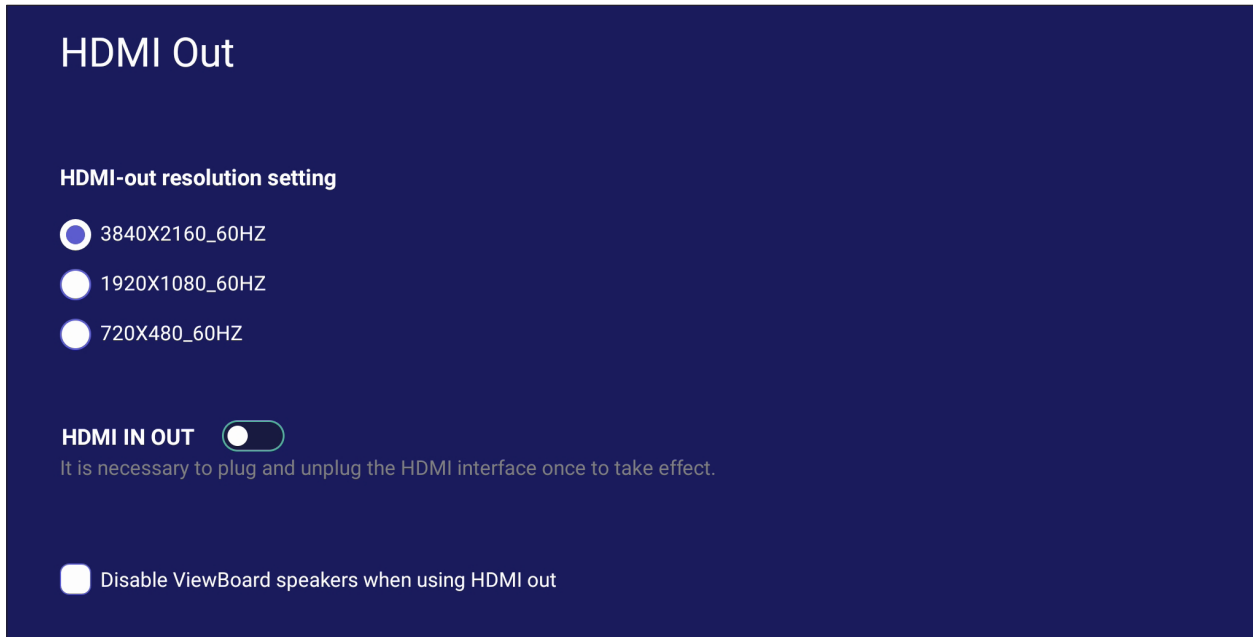

## Preference

View and adjust **Touch, Language, Keyboard & Input, Date & Time, Boot Mode & Advanced, Start up & Shut down, and Toolbar** settings.

**Settings**

- Network & Internet
- Filesharing
- Display
- Preferences**
- Input source
- Apps
- System

**Touch**  
Touch sounds and Windows Ink.

**Language**  
Select your preferred language.

**Keyboard & input method**  
Virtual and current keyboard.

**Date & time**  
Set time zone and format

**Boot mode & Advanced settings**   
Set the Boot mode, password for ViewBoard settings, and local file

**Startup & shutdown**  
Select input, standby mode and boot schedule.

**Toolbar settings**  
Toolbar settings

## Touch

Adjust **Touch Settings** and toggle **Touch Sounds** and **Windows Ink On/Off**.



## Language

Adjust and choose the preferred language from the available languages.

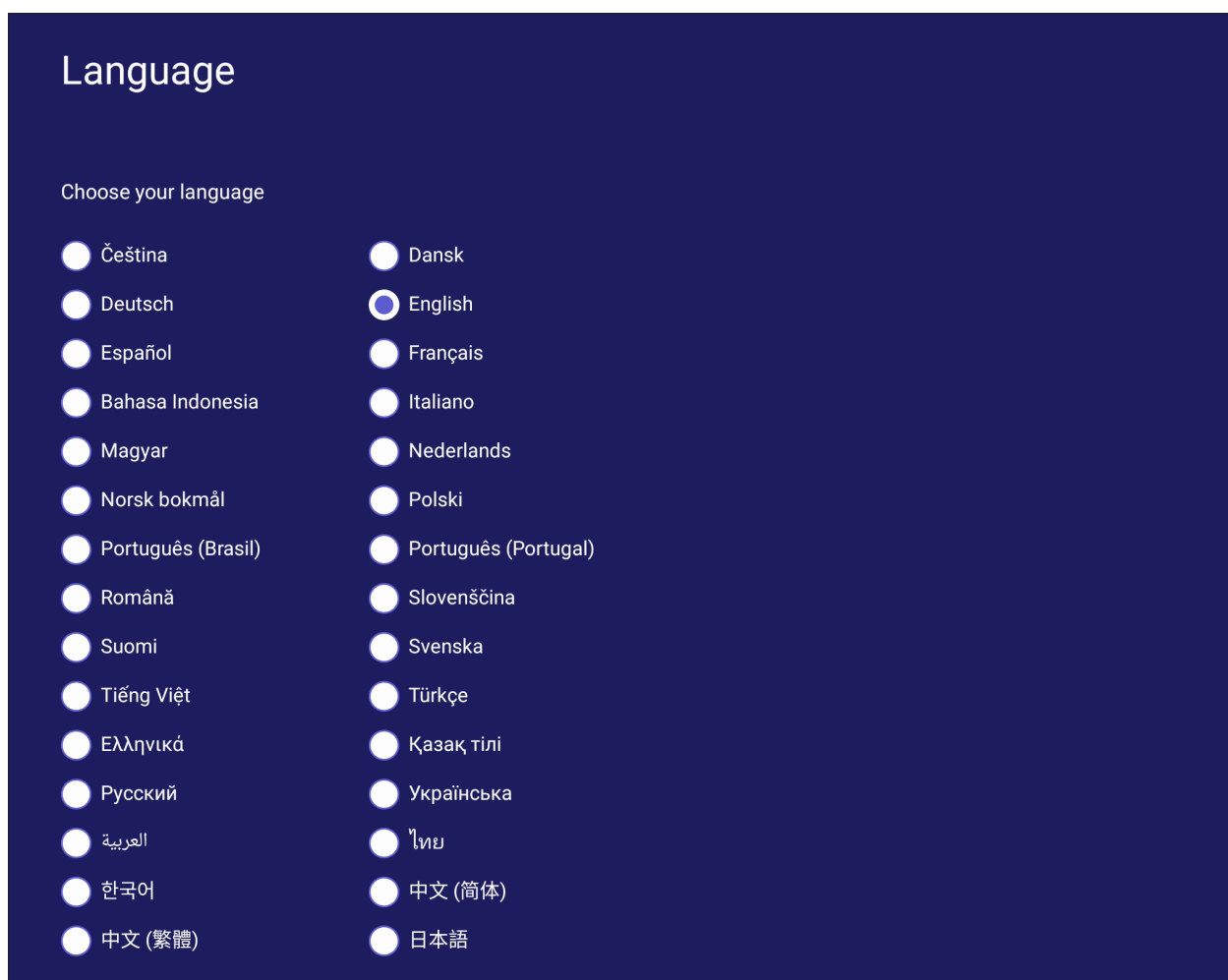

## Keyboard & Input Method

Enable/disable the visual keyboard and/or change the default input method.



- Tap on **Settings** to adjust the advanced keyboard settings.

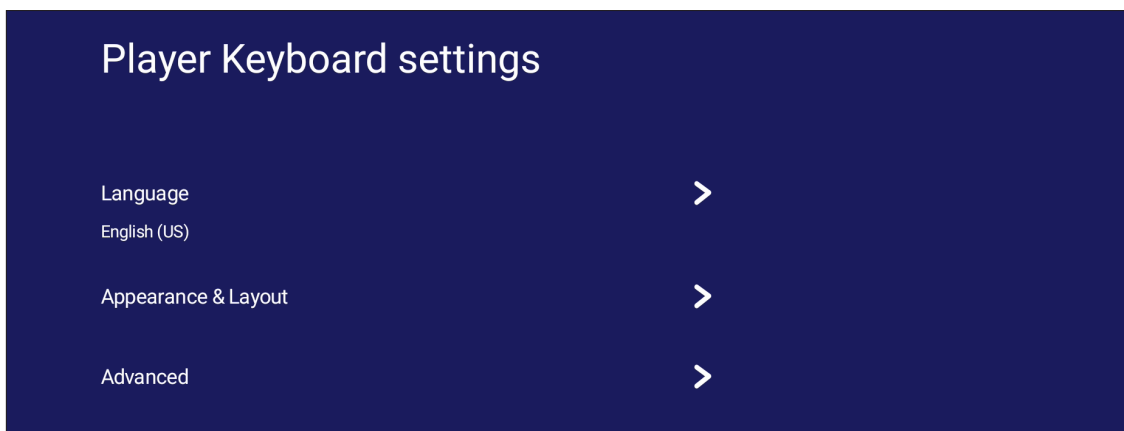
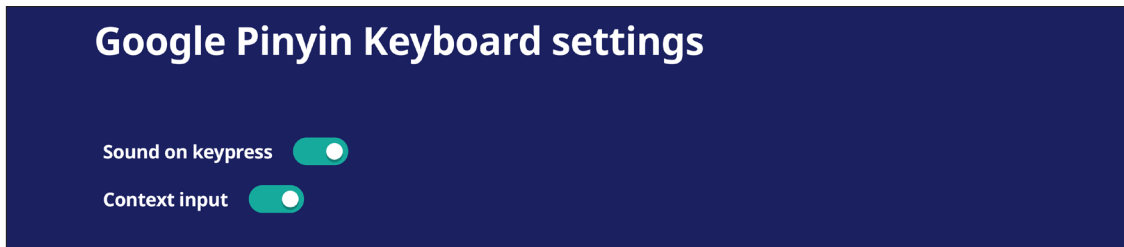

## Date & Time

Set the system time and format.

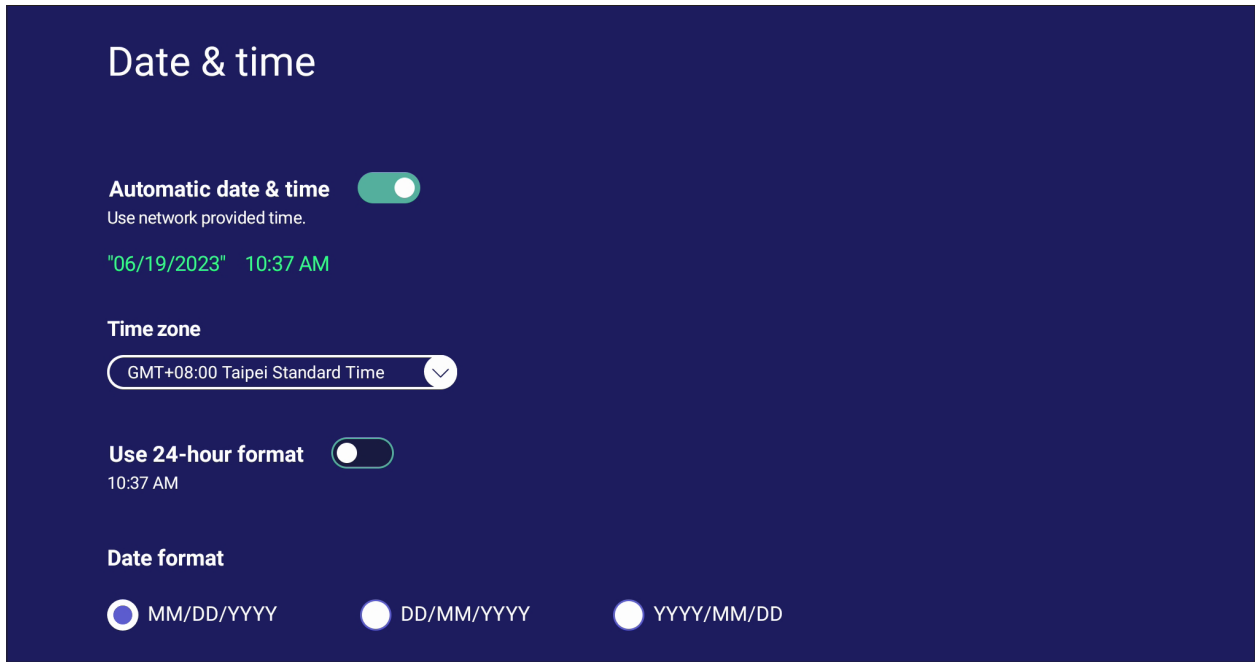

Item	Description
<b>Automatic Date &amp; Time</b>	When enabled, the ViewBoard will automatically synchronize the date and time via the Internet.
<b>Time Zone</b>	Select the appropriate time zone.
<b>Time Format</b>	Choose from 12-hour or 24-hour time format. Simply toggle 24-hour format On/Off.
<b>Date Format</b>	Select from the available date formats.

# Boot Mode

Adjust the preferred boot up mode and set/reset a password.

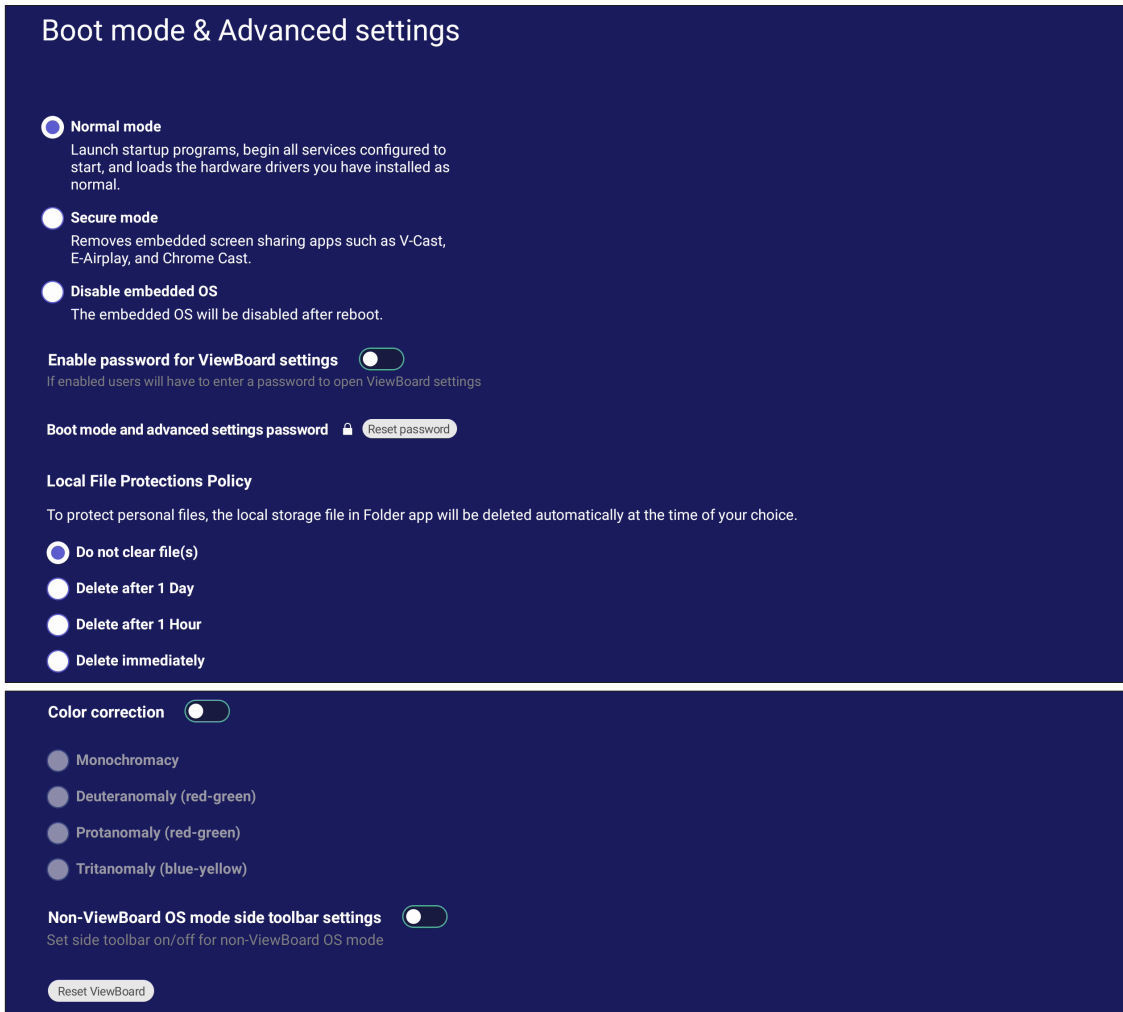

Item	Description
<b>Normal Mode</b>	The embedded screen sharing Apps will run normally.
<b>Secured Mode</b>	The embedded screen sharing Apps will be removed.
<b>Disable Embedded OS</b>	The system will automatically reboot, and then the Embedded OS will not appear.
<b>ViewBoard Settings Access Password</b>	Toggle to lock/unlock the ViewBoard Settings.
<b>Password for Protection</b>	Modify the Boot mode and ViewBoard Settings entry password.
<b>Local File Protection Policy</b>	Choose how long to keep local storage files in the Folder application.
<b>Color Correction</b>	Color correct the ViewBoard display screen.
<b>Non-ViewBoard OS Mode Side Toolbar Setting</b>	Enable the side toolbar for non-ViewBoard OS.
<b>Reset ViewBoard</b>	Reset the ViewBoard to its factory default settings.



# Startup & Shutdown

Set the **Startup Input**, **Standby Mode**, **EnergyStar Mode**, **Black Screen After Startup**, **Power off Reminder** timer and **Schedule** settings.

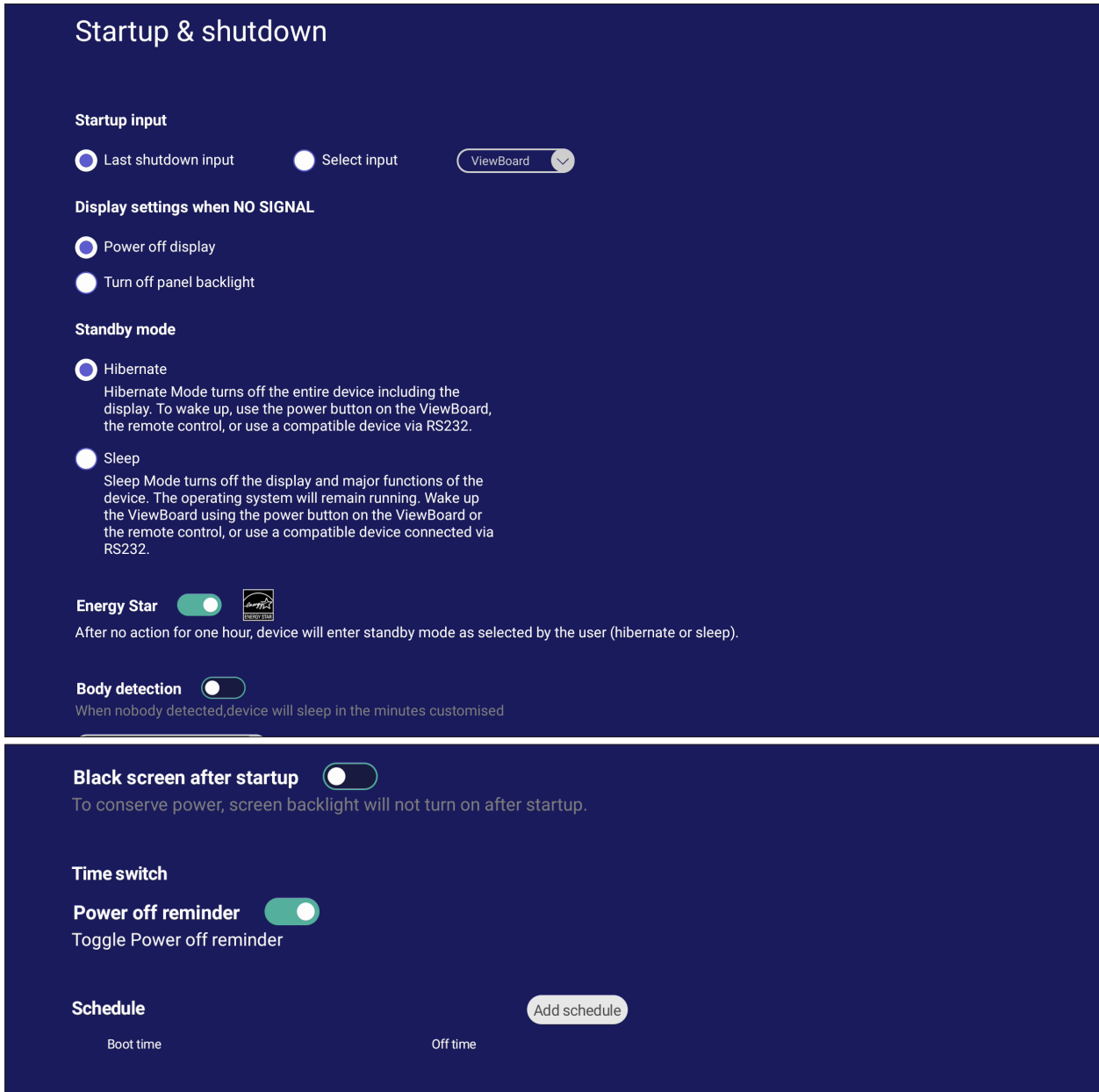

Item	Description
<b>Startup Input</b>	Adjust the Startup Input preference.
<b>Display Setting when No Signal</b>	Decide what happens to the display when there is no signal for HDMI, PC, or VGA sources.
<b>Standby Mode</b>	Decide what happens when you press the Power button while the ViewBoard is On.
<b>Energy Star</b>	Enable to automatically initiate Sleep Mode when the screen is idle for one hour.
<b>Body Detection</b>	If no body is detected, the display will enter sleep mode based on the minutes set.

<b>Item</b>	<b>Description</b>
<b>Black Screen After Startup</b>	When enabled, the ViewBoard will turn off the backlight automatically after booting up.
<b>Time Switch Power Off Reminder</b>	When enabled, the ViewBoard will turn off without any reminder after the scheduled off time.
<b>Schedule</b>	Schedule a Boot and Shut off time.

## Toolbar Setting

Adjust the Side toolbar settings.

### Toolbar settings

**Side toolbar settings**

- Show side toolbar
- Hide side toolbar
- Disable in all input port sources

## Input Source

Adjust the input source names and settings, as well as the side toolbar settings.

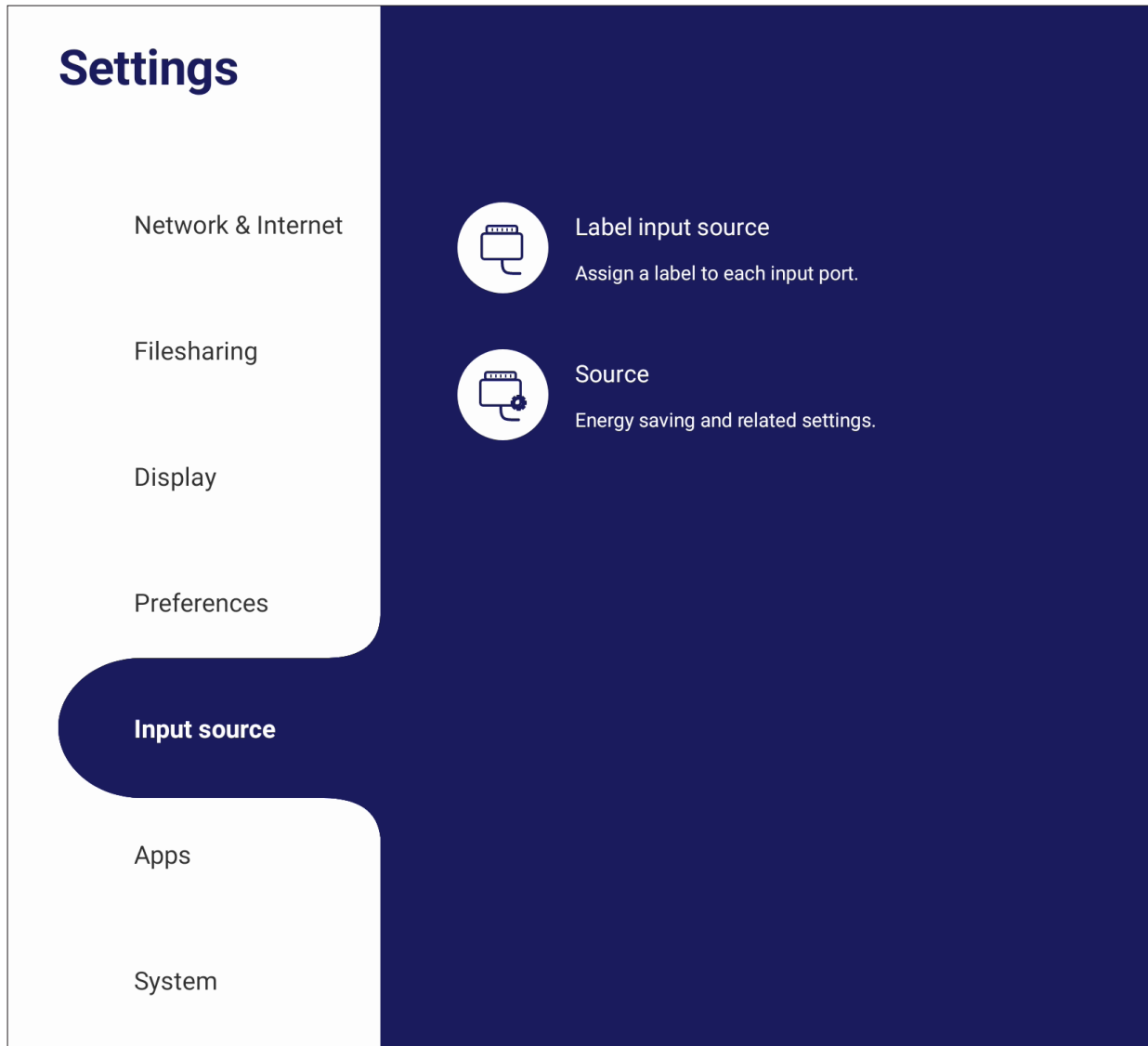

## Label Input Source

Set labels for each input source that will be easily recognized when displayed.

Label input source

Add a label to help you recognize input ports easier.

Source	Label	
ViewBoard	<input type="text" value="ViewBoard"/>	
HDMI1	<input type="text" value="HDMI1"/>	<input checked="" type="checkbox"/>
HDMI2	<input type="text" value="HDMI2"/>	<input checked="" type="checkbox"/>
HDMI3	<input type="text" value="HDMI3"/>	<input checked="" type="checkbox"/>
Type-C	<input type="text" value="Type-C"/>	<input checked="" type="checkbox"/>
VGA	<input type="text" value="VGA"/>	<input checked="" type="checkbox"/>

## Source

Toggle Wake up by active source, Signal auto search, and HDMI CEC and select Input port auto switch.

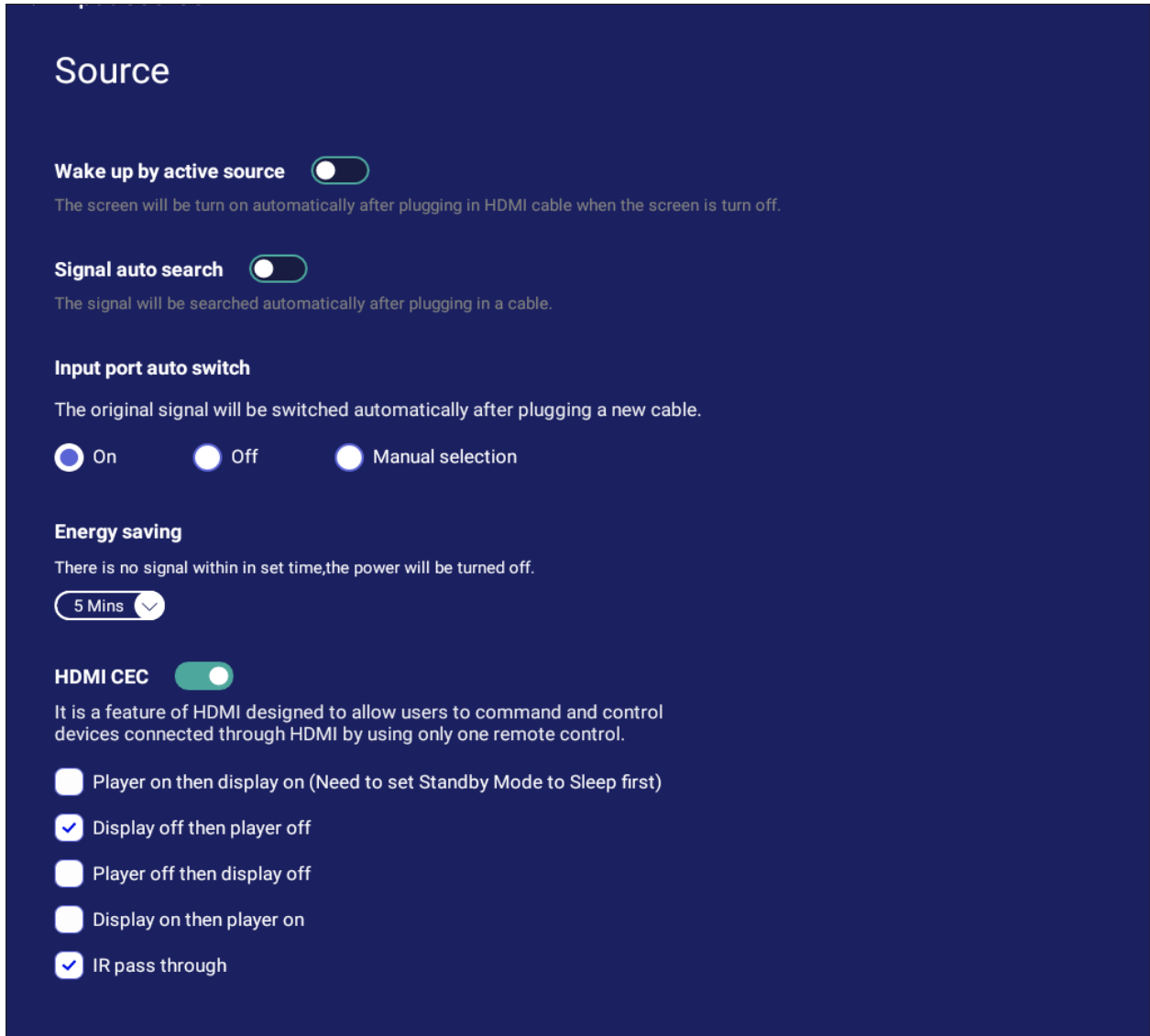

Item	Description
<b>Wake up by Active Source</b>	The screen will turn on automatically after plugging in an HDMI cable when the screen is off.
<b>Signal Auto Search</b>	When enabled, if the current source does not have a signal, the ViewBoard will automatically search for an input source.
<b>Input Port Auto Switch</b>	The original signal will automatically switch to a new cable after it's plugged in.
<b>Energy Saving</b>	Set a time period to power off if no signal is detected.
<b>HDMI CEC</b>	Enable/disable HDMI CEC functions.

## Apps

The user can view application information and force stop, uninstall, move to USB storage, clear data, clear cache, and clear defaults.

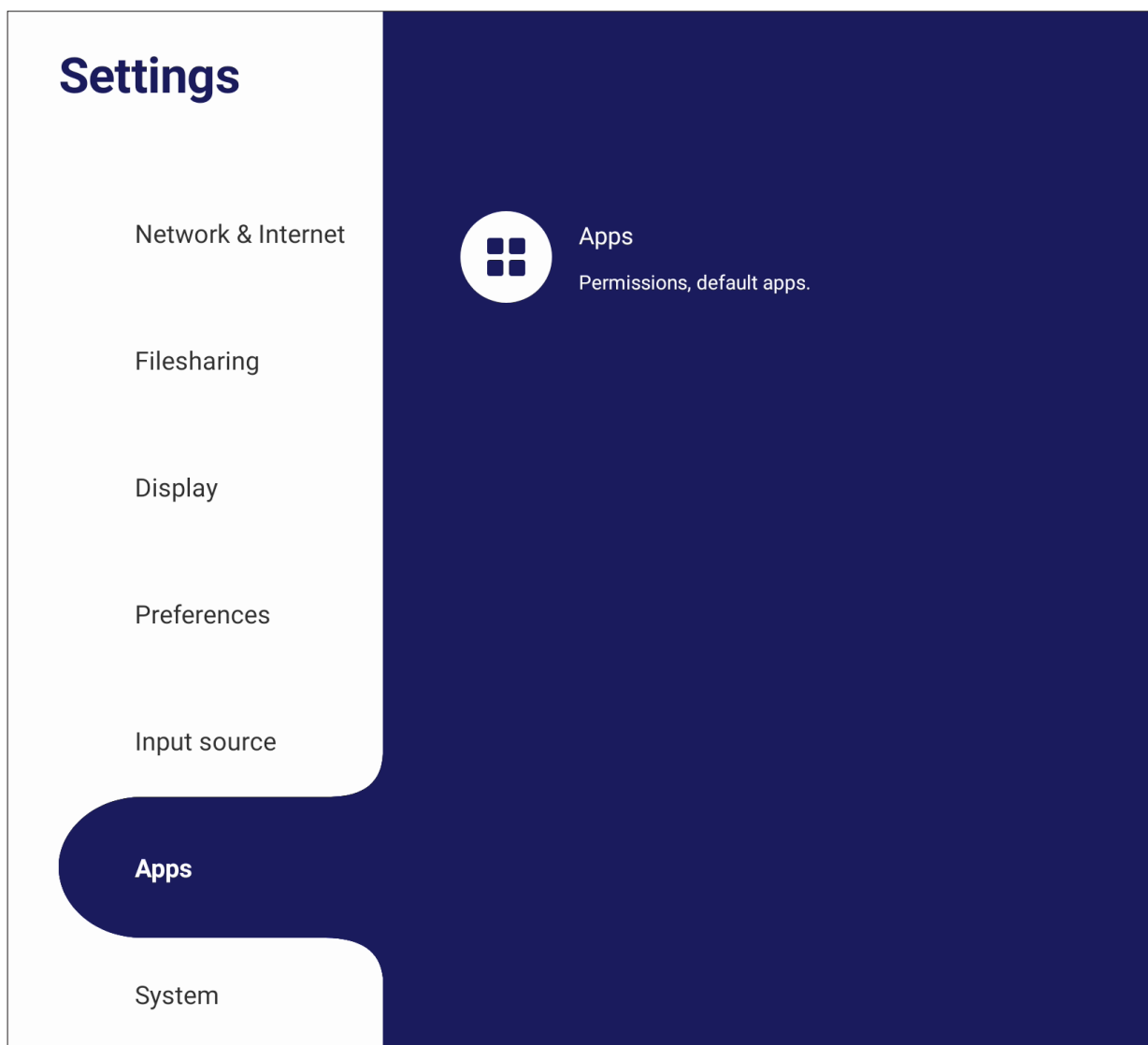

### NOTE:

- Pre-loaded apps cannot be uninstalled.
- Not all apps support the move to USB storage feature.
- Not all apps support Clear Defaults.

## Apps

View any running or installed applications. Tap on them for more detailed information and options.

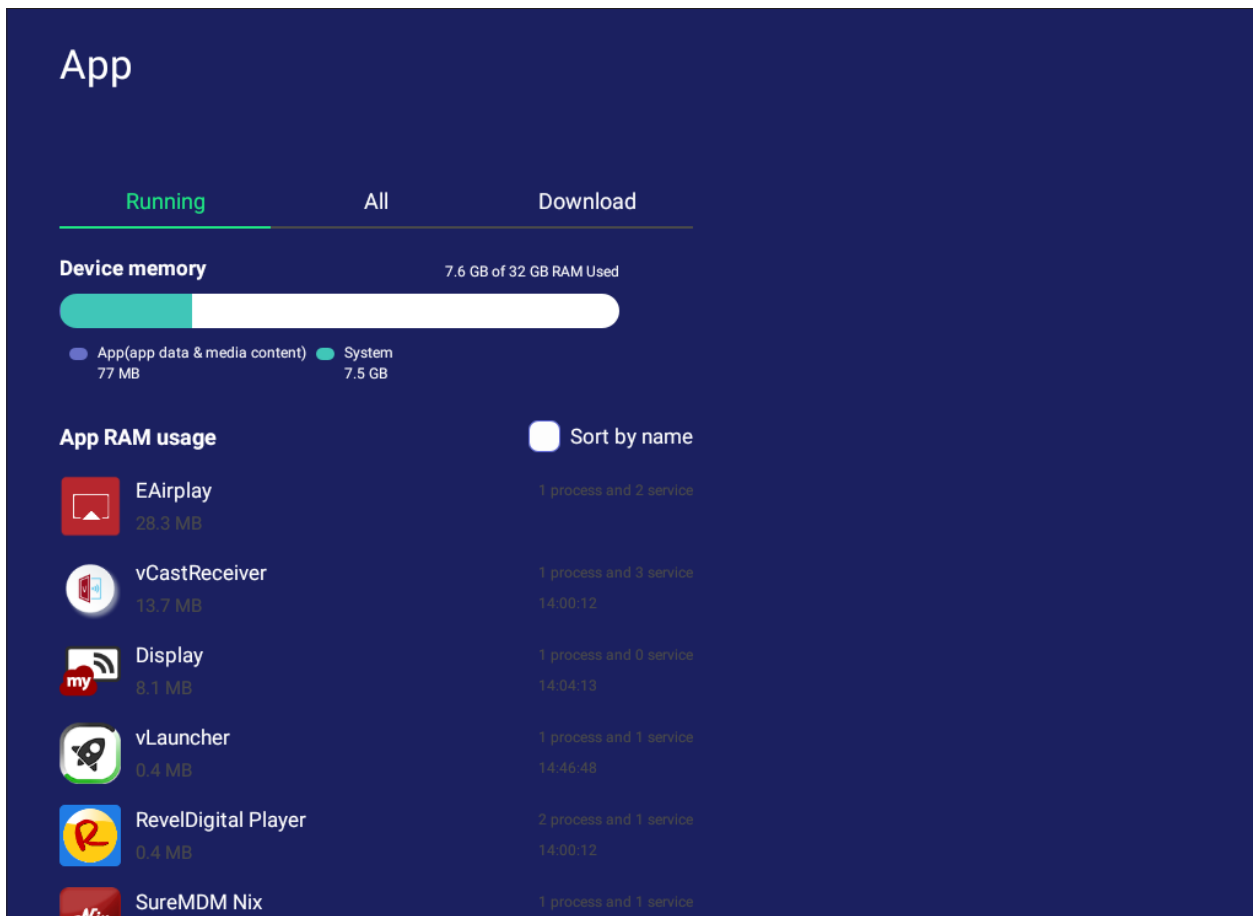

- By tapping on a running application, you can see more information, stop, or report the application.

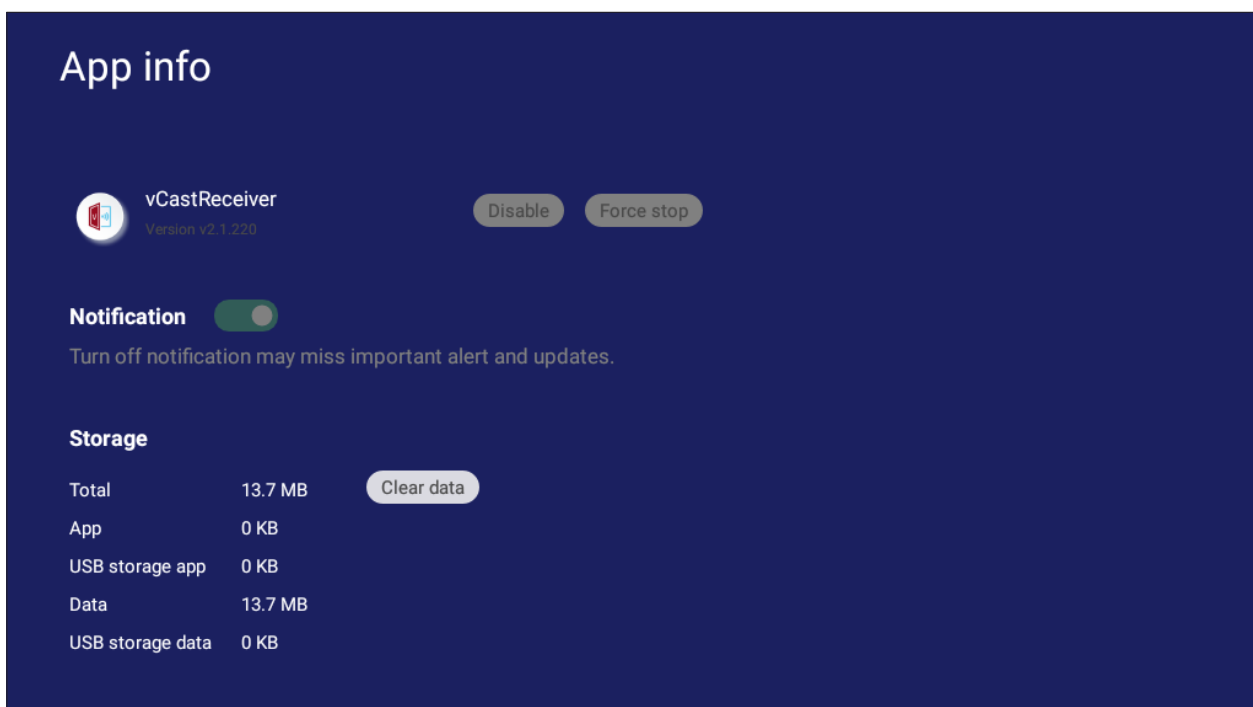



- Selecting **All**, **Download**, or **USB storage** will list all installed applications.

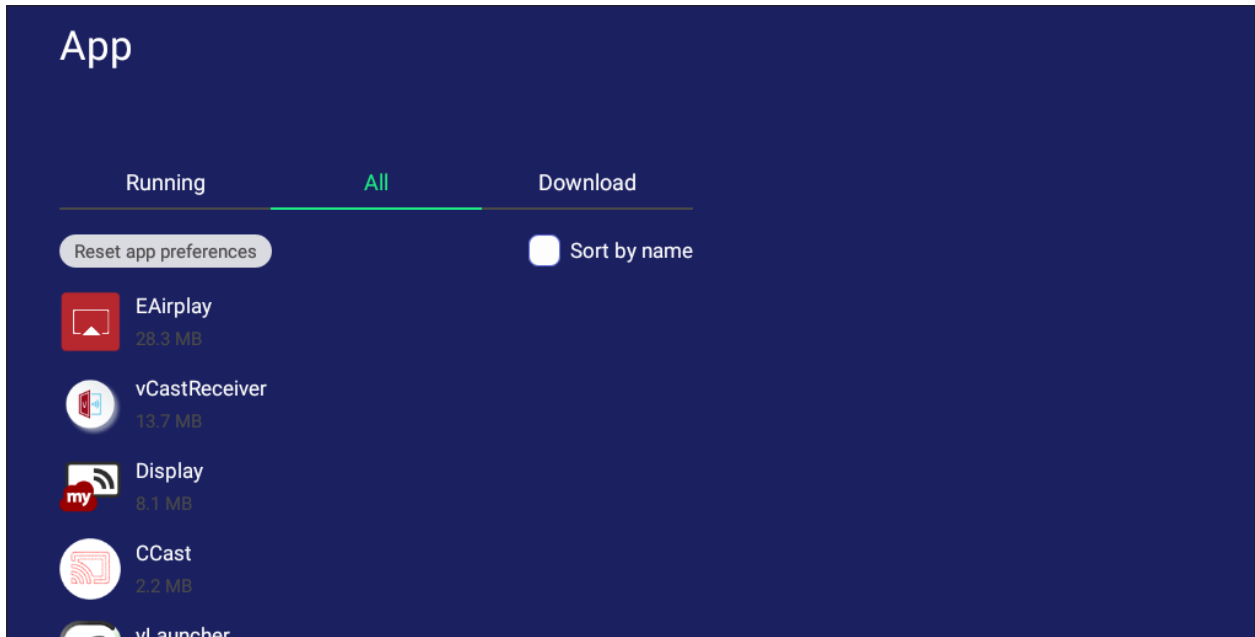

- Tapping on any application will display further information and options.

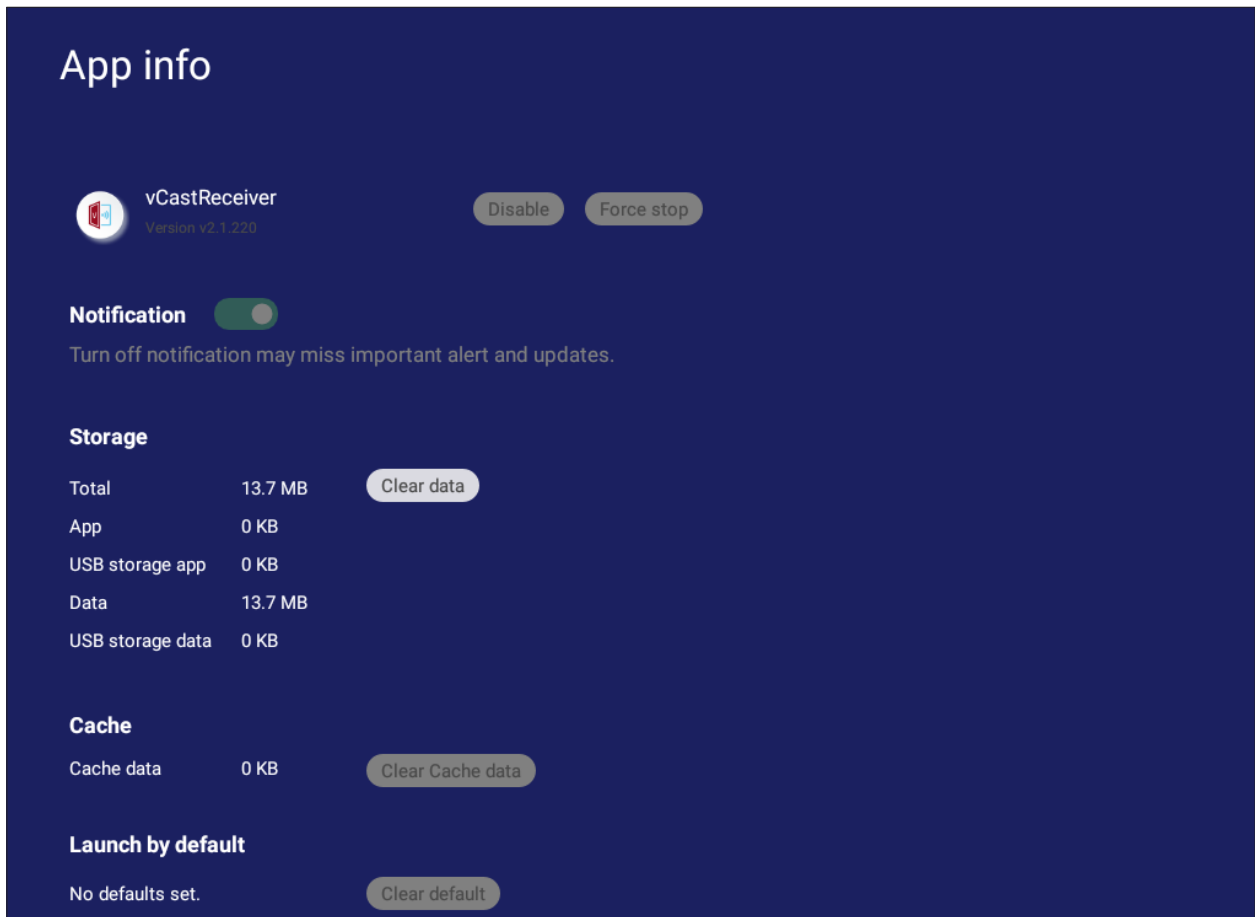

## System

View and adjust **Clone to USB**, **Display ID**, **Security**, **System Update**, and **About device** settings.



## Clone to USB

Copy settings to an external USB drive.

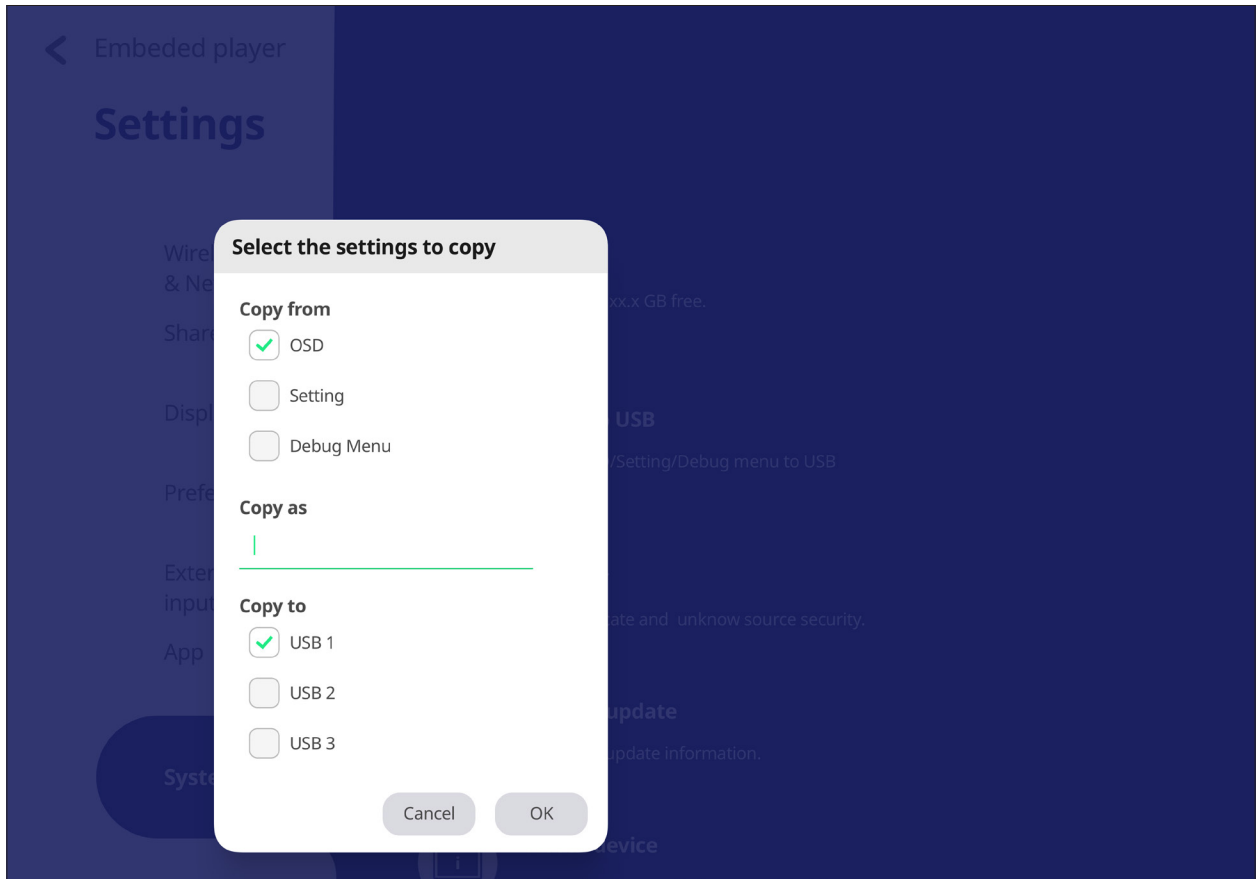

## Display ID

Assign a number to remote control the display by RS-232/LAN.

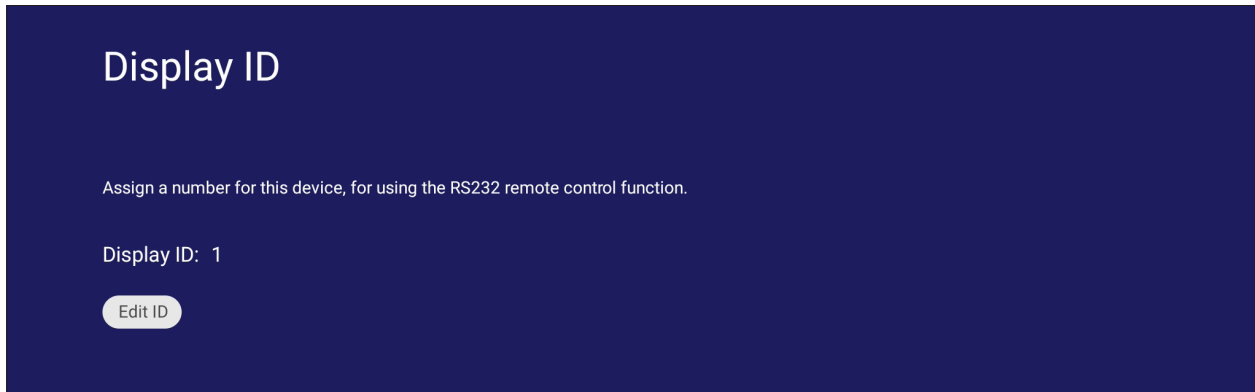

- To assign or change the Display ID, tap **Change** and input a number.

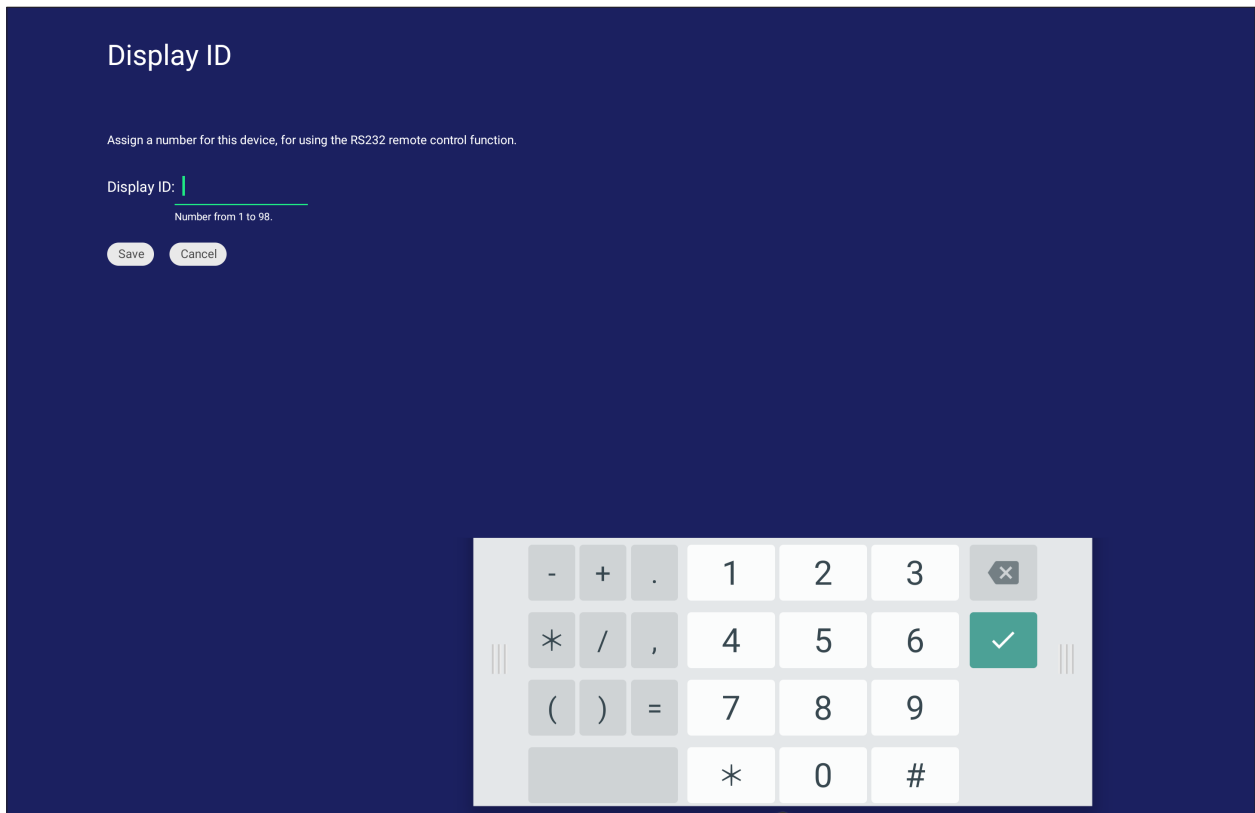

**NOTE:** The Display ID is for RS-232 users, and the range is 01~99.

## Security

Review **Certificate**, **Trusted Credential** storage, and **Unknown sources** install settings.

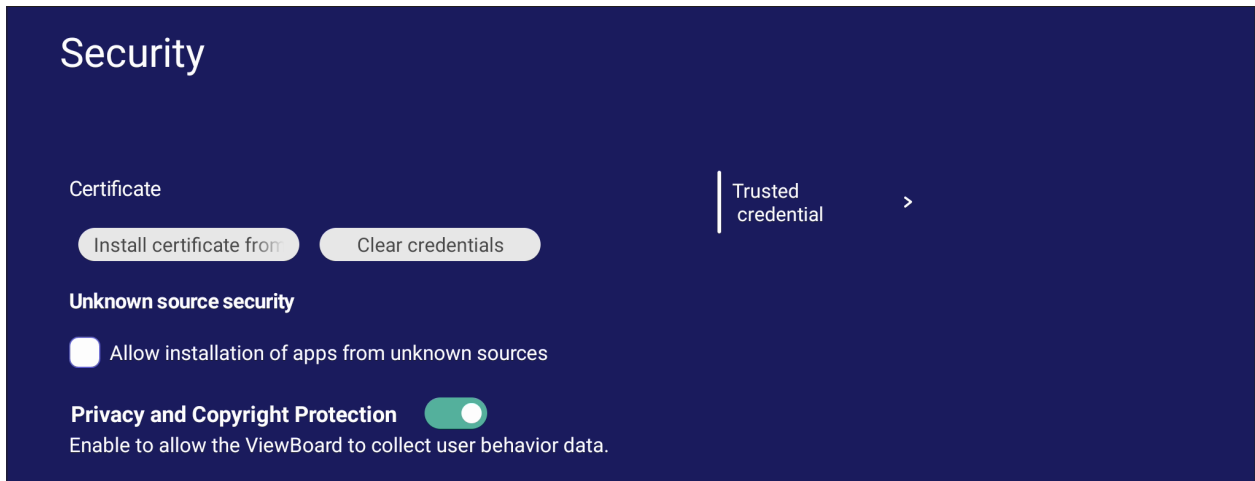

- Tap on **Install certificate from storage** to add additional certificates.

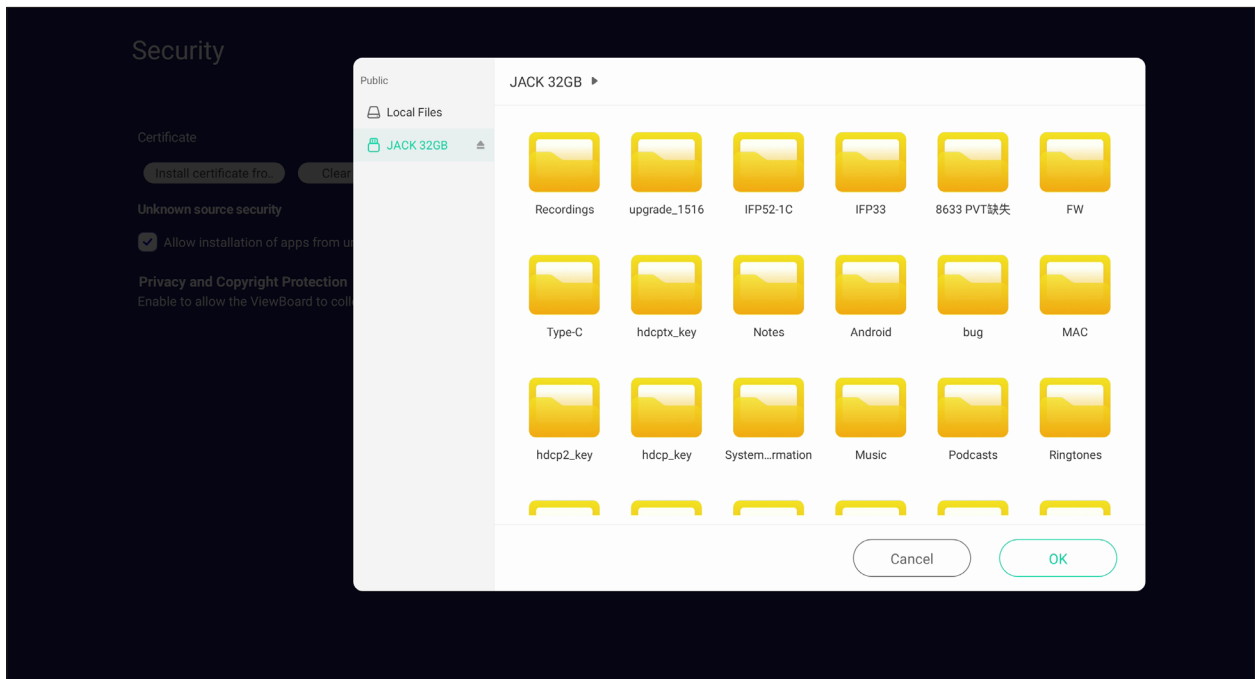

- Selecting **Clear Credentials** will remove all manually installed credentials.

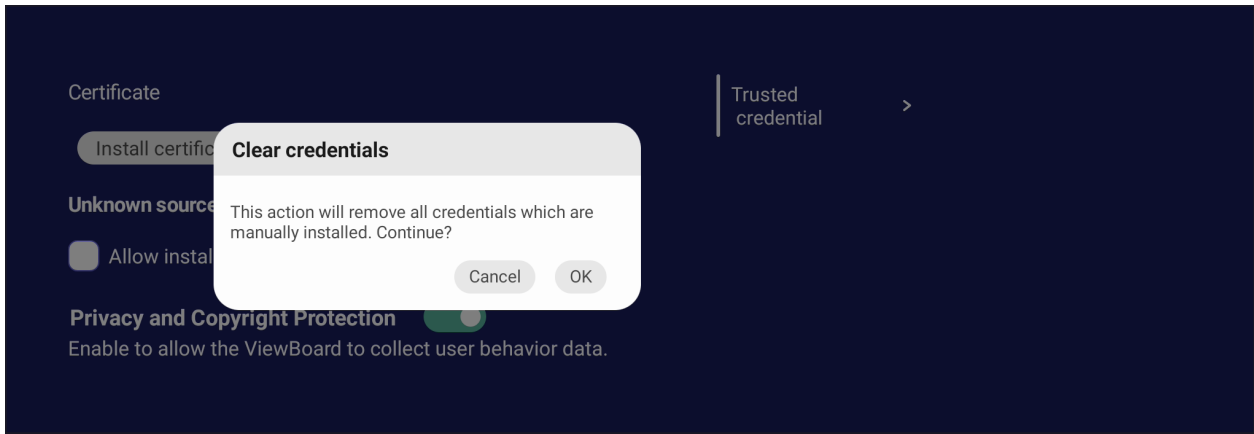

**NOTE:** Pre-loaded credentials cannot be cleared.

- Under **Trusted Credentials** view and edit all trusted and installed CA certificates.

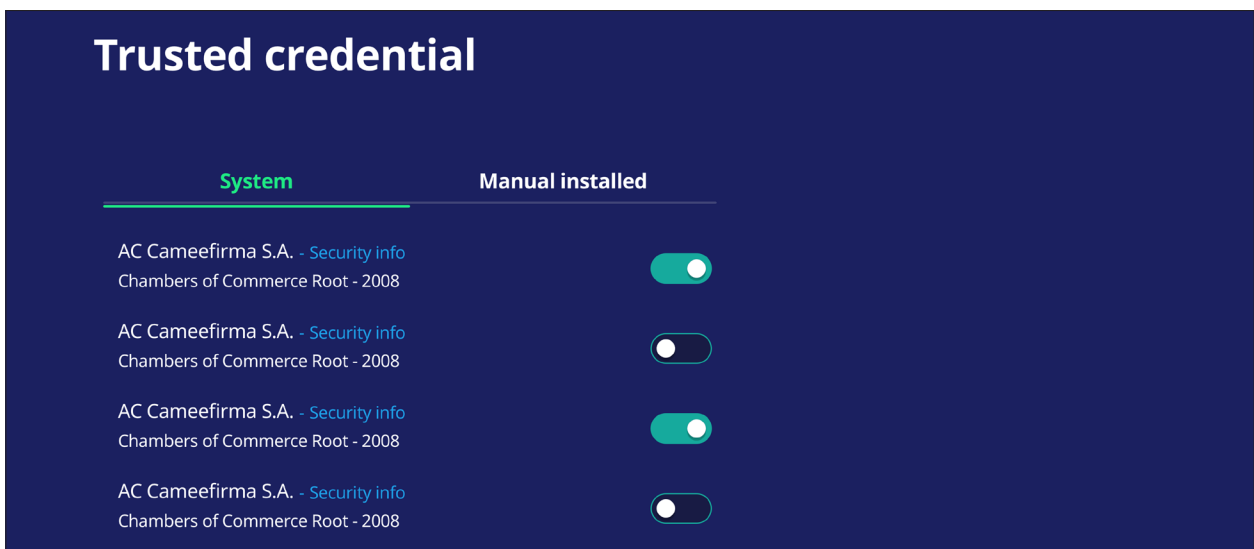

- Tapping on a credential will provide more detailed information.

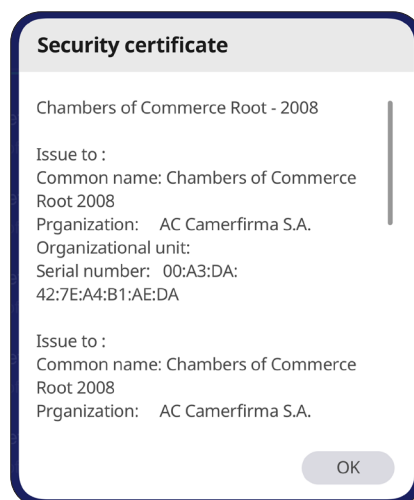

- Allow the installation of applications from unknown sources by selecting the box under **Unknown source security**.

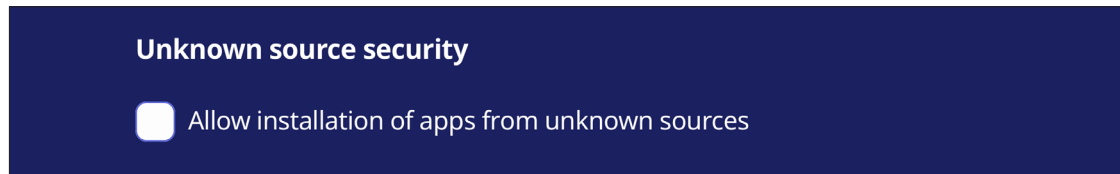

**NOTE:** Applications from unknown sources may not be compatible or work properly.

## System Update

The ViewBoard automatically searches for software updates whenever connected to the Internet (OTA). With just one click, users can update their version of ViewBoard software.

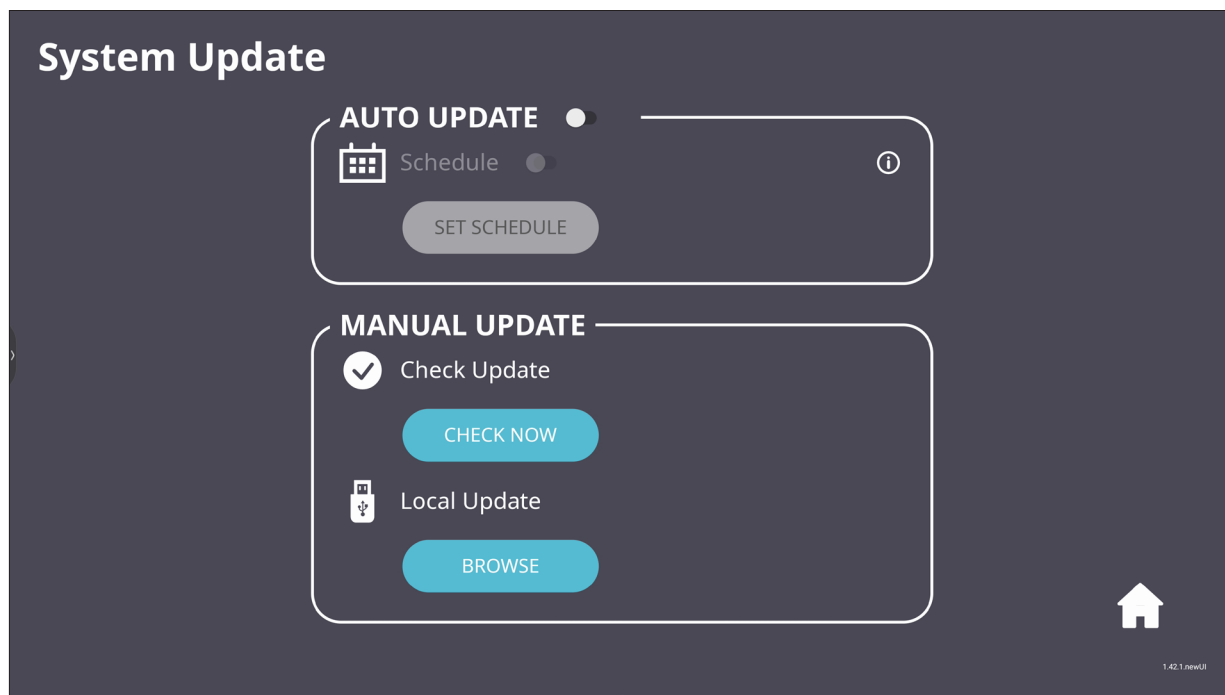

Item	Description
<b>Auto Update</b>	When the display is off, the system will automatically check for a new version. If a new version is found, the system will automatically update. After the update is complete, the system will turn off.
<b>Schedule</b>	Set the update time.
<b>Manual Update</b>	Update the software manually.



## About Device

Display Embedded Player information, **Legal information**, and **Asset Tagging**.

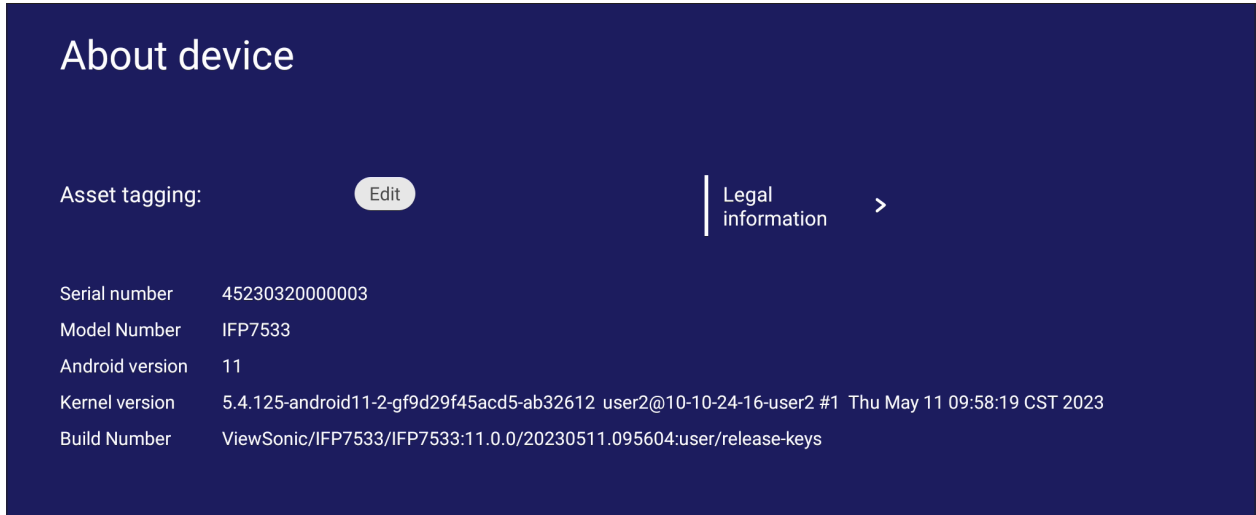

- By selecting **Edit**, the asset information can be adjusted.

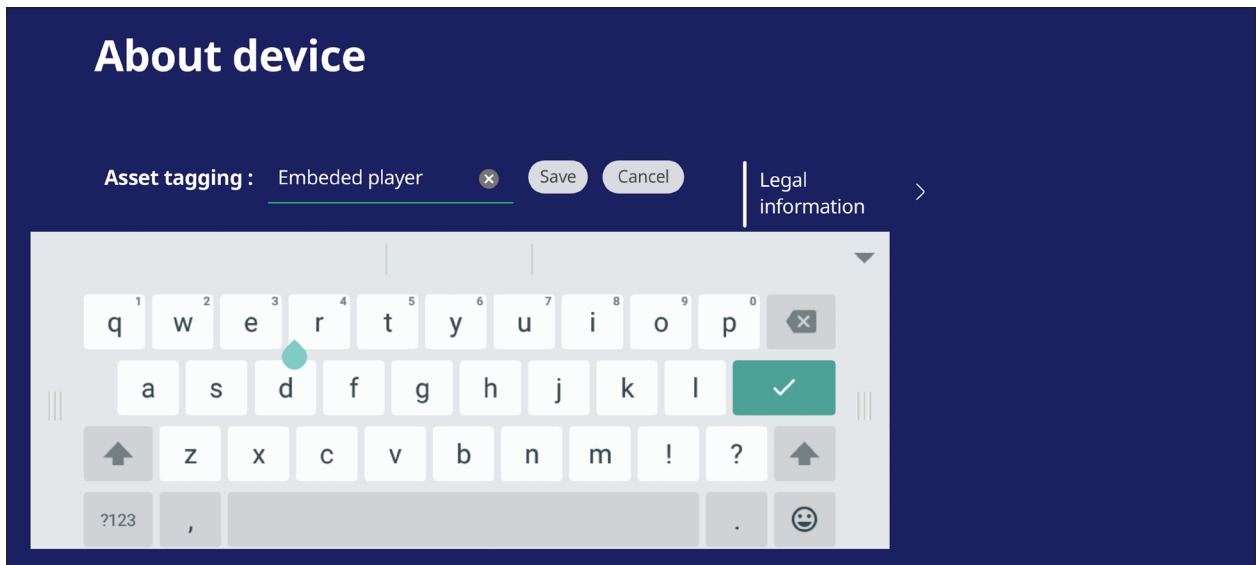

- Tap on **Legal information** to check open source licenses.



# Pre-installed Applications and Settings

## myViewBoard Display

Wirelessly mirror screens to a larger display.

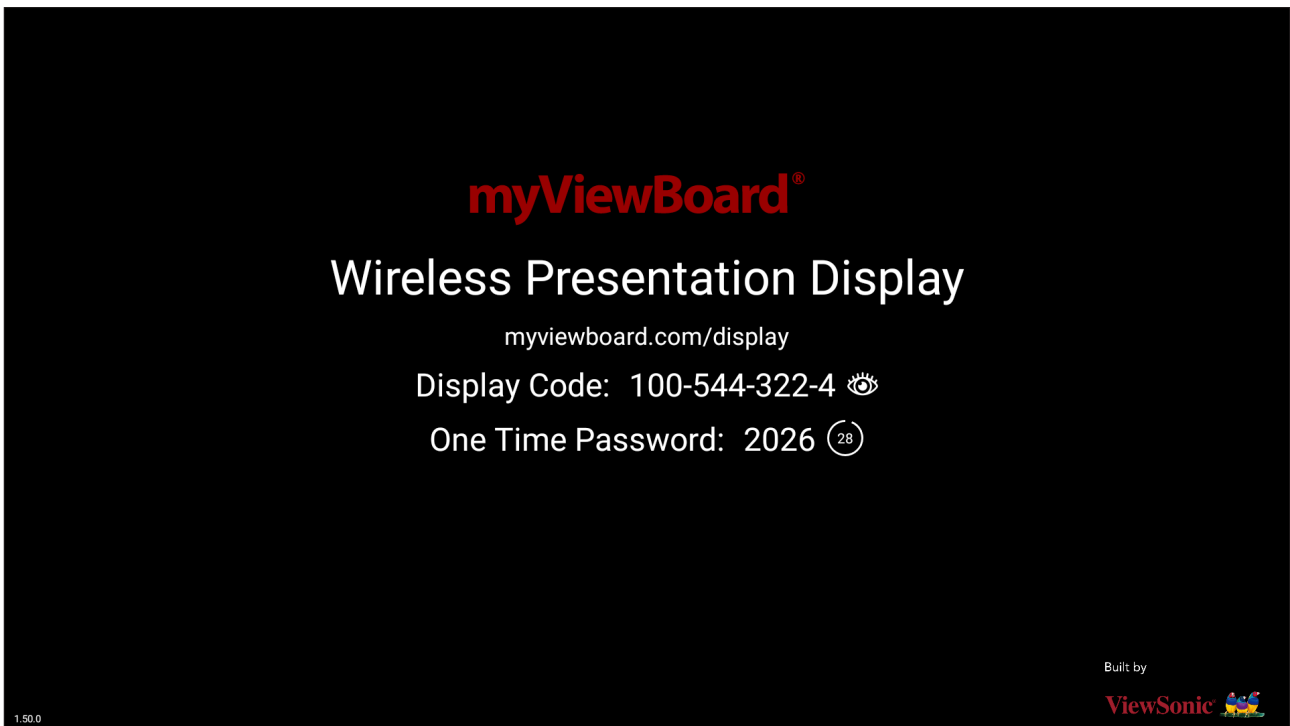

To share a screen to a ViewBoard with myViewBoard Display:

1. Open myViewBoard Display on the ViewBoard you want to share your screen to.
2. On the device you want to share the screen from, go to: <https://myviewboard.com/display>.
3. Enter the **Display Code** and **One Time Password** for the ViewBoard you wish to share to.

**NOTE:** Note that the password refreshes every 30 seconds.

# myViewBoard Live

Stream whiteboarding sessions.

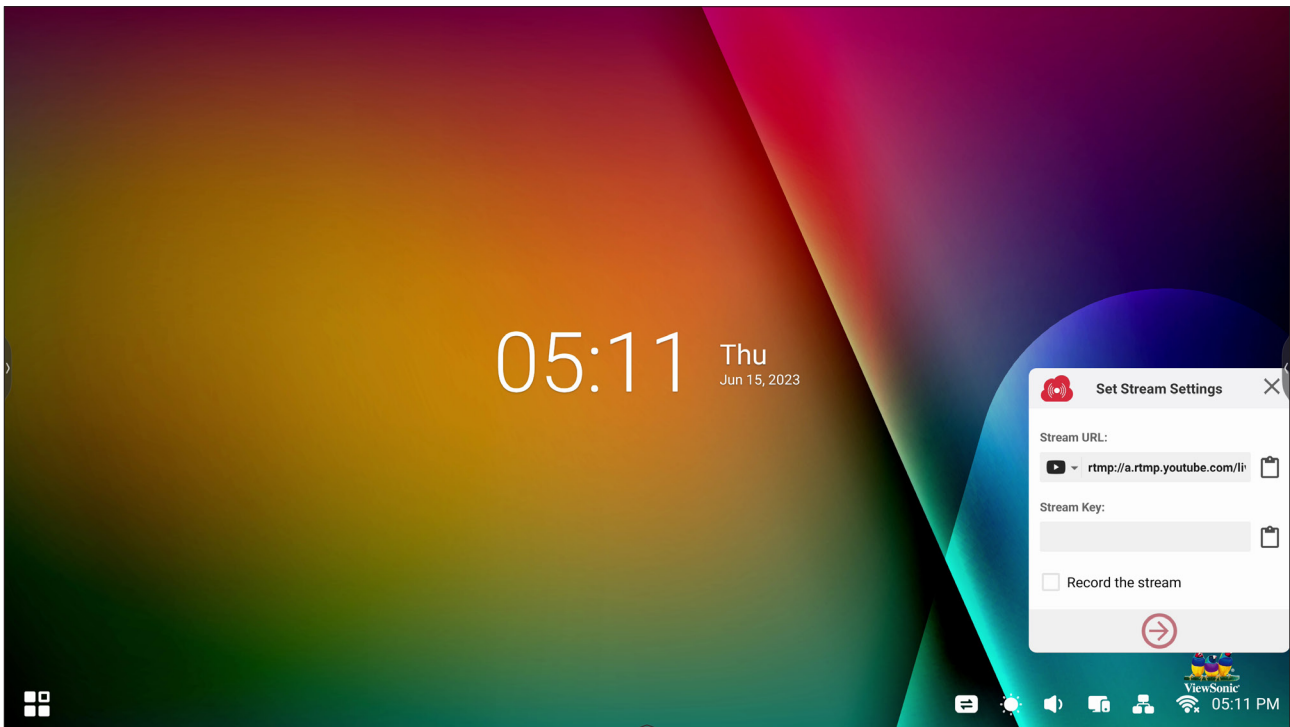

A **Stream URL** and a **Stream Key** are needed to begin live streaming. The **Stream URL** is automatically shown after selecting the streaming service in myViewBoard Live.

**NOTE:** The **Stream Key** will come from the streaming service chosen.

On myViewBoard Live:

1. Launch myViewBoard Live.
2. Input the required information.
3. Select the **Record the stream** checkbox to record a copy of the stream to the ViewBoard (if applicable).
4. Tap the arrow icon to start the stream.

On the dashboard of the chosen streaming service:

1. Verify that it is able to successfully receive the stream.
2. To stop the stream, locate and click the 'End Stream' button on the chosen service's dashboard.

**NOTE:** To learn more about myViewBoard Live, visit: [https://wiki.myviewboard.com/MyViewBoard\\_Live](https://wiki.myviewboard.com/MyViewBoard_Live).

# myViewBoard Manager

Remotely manage multiple installations of ViewSonic devices.

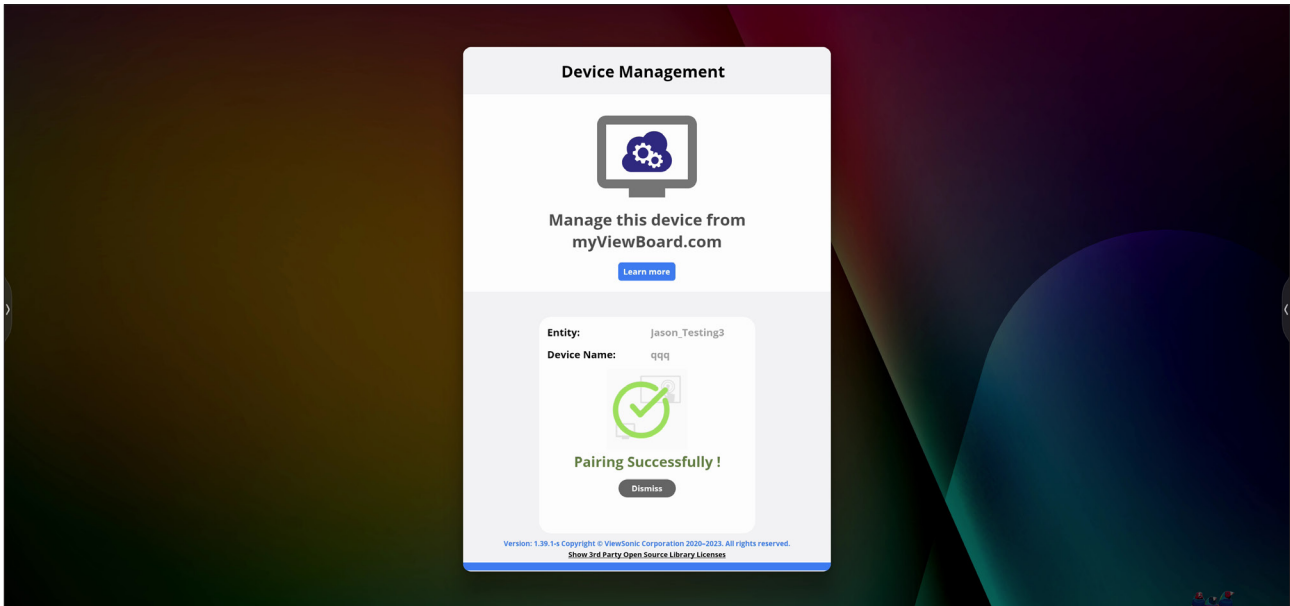

Once devices are set up and have myViewBoard Manager installed, they can be added to the entity and managed remotely from the Manager web application.

**NOTE:** Only available to Entity Admins from myviewboard.com after signing in.

## Add a Device

On the device to manage:

1. Download and install myViewBoard Manager.
2. Open myViewBoard Manager and note the 6-digit PIN displayed.

In the myViewBoard Manager web application on myviewboard.com:

1. Click **Add Device**.
2. Input the 6-digit PIN obtained earlier.
3. Name the device (if applicable).
4. Click **Add**.

**NOTE:** To learn more about myViewBoard Manager, visit: [https://wiki.myviewboard.com/MyViewBoard\\_Manager](https://wiki.myviewboard.com/MyViewBoard_Manager).

# myViewBoard Record

Capture everything that is displayed on screen in a video format.

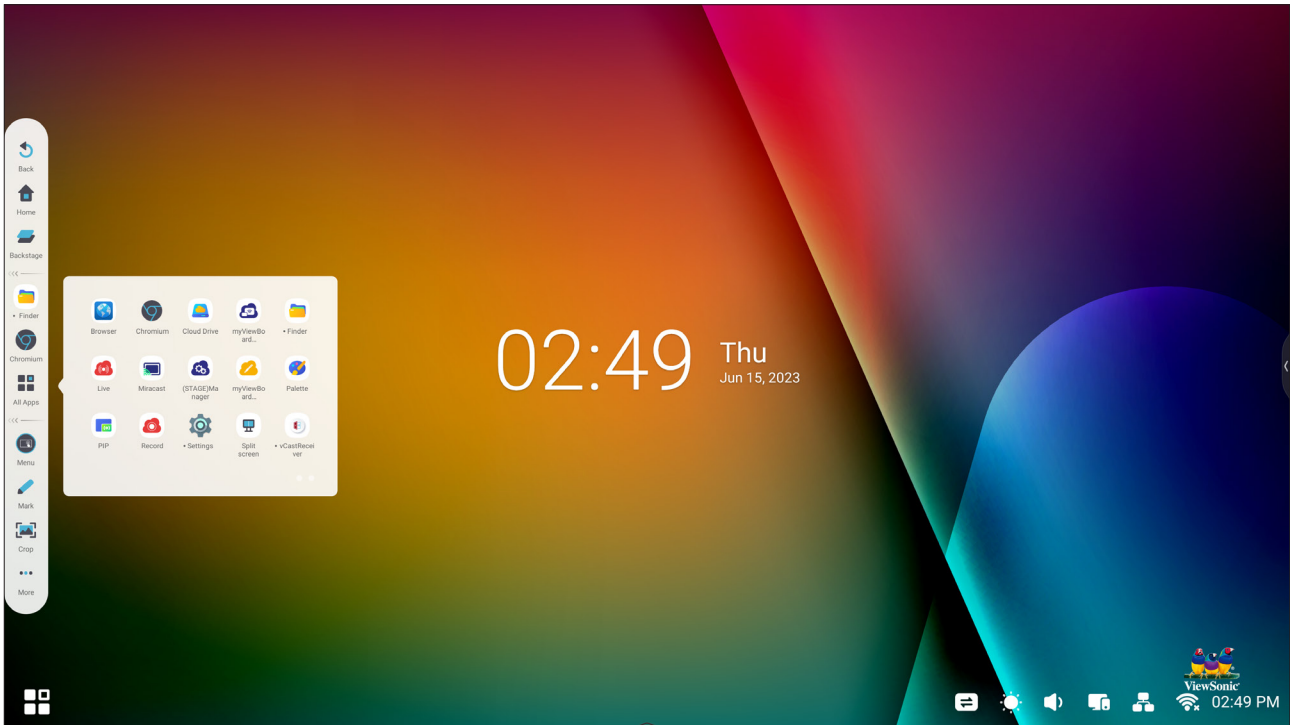

To launch the screen recording application:

1. Select the myViewBoard Record icon in the application drawer.
2. Select the preferred recording configurations.

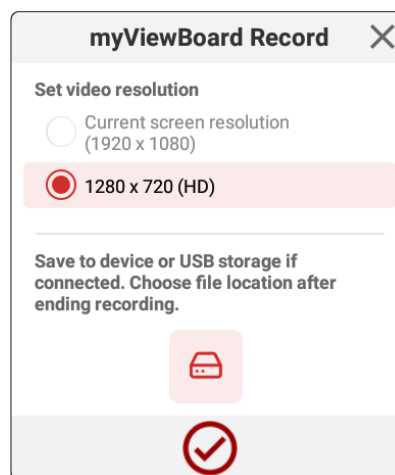

3. Tap the check mark and a three (3) second countdown will begin. Screen recording will begin immediately after the countdown.
4. After stopping the recording, you will be able to preview the video, save it, or discard it.

# myViewBoard Whiteboard

A digital whiteboarding application.



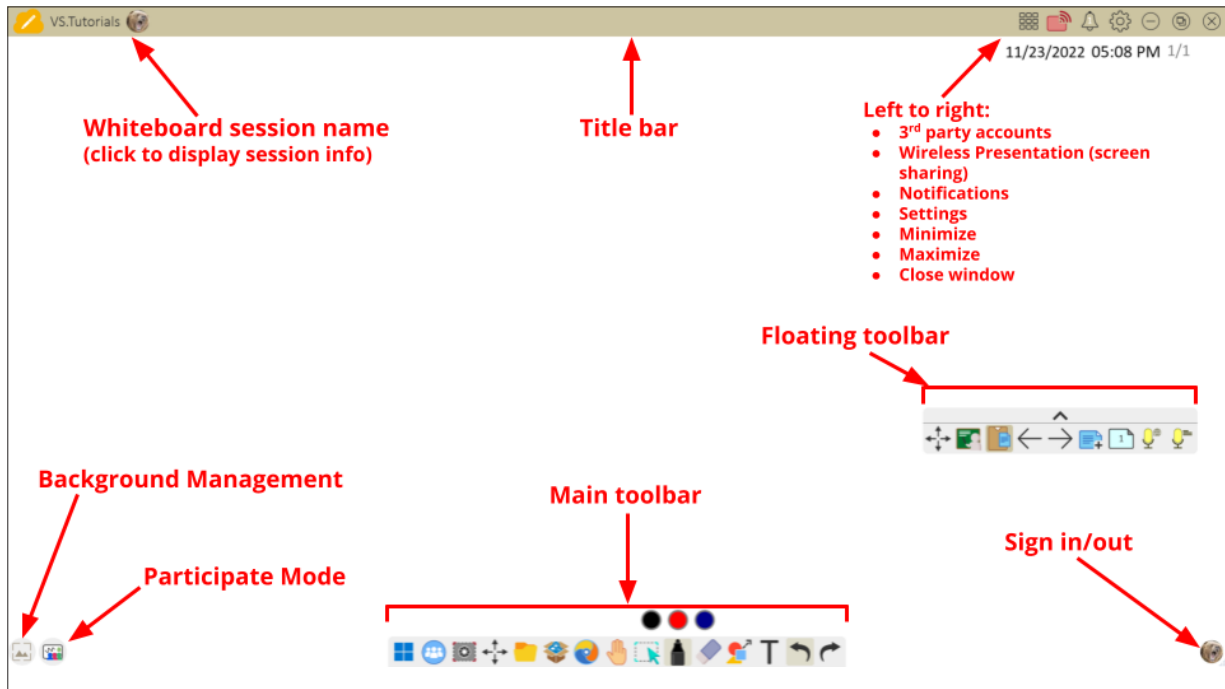









**NOTE:** To learn more about myViewBoard Whiteboard, visit: [https://wiki.myviewboard.com/Whiteboard\\_for\\_Android](https://wiki.myviewboard.com/Whiteboard_for_Android).









## Floating Toolbar

Item	Description
	<b>Move</b> Move the Floating Toolbar.
	<b>Present Mode</b> Switch between presentation and preparation modes.
	<b>Paste from Clipboard</b> Insert the current clipboard content onto the canvas.
	<b>Previous Page</b> Go to the previous page (if the canvas has multiple pages).
	<b>Next Page</b> Go to the next page (if the canvas has multiple pages).
	<b>New Page</b> Add a new canvas.
	<b>Pages in Whiteboard</b> Create, select, rearrange, copy and delete pages.

## Main Toolbar

	Item	Description
	<b>Screen Capture</b>	Screenshot, video, and audio recording.
	<b>Move</b>	Select and hold to move the toolbar to the left side, right side, or bottom of the screen.
	<b>File</b>	Open, save, export, and print whiteboard files.
	<b>Magic Box</b>	Import resources (image, video, audio, etc.) to the whiteboard.
	<b>Embedded Browser</b>	Open the built-in browser to access internet resources, which can be dragged onto the canvas.
	<b>Infinite Canvas</b>	Drag to move the canvas. Use two hands to zoom in/zoom out. Select again for an overview.
	<b>Selection</b>	Select objects, text, and other elements on the canvas.
	<b>Pen</b>	Writing tools and customization options.
	<b>Eraser</b>	Erase objects or clear the page.
	<b>Shapes and Lines</b>	Draw shapes, arrows, and add tables.
	<b>Text and Handwriting</b>	Add a text box.
	<b>Undo</b>	Undo the previous action.
	<b>Redo</b>	Redo the previous action.

## Background Management

Item		Description
	<b>Sign In</b>	Sign in to a myViewBoard account.
	<b>Background Management</b>	Change the canvas background.
	<b>FollowMe Setting</b>	Display custom images uploaded to a cloud storage account.
	<b>Color Palette</b>	Choose from solid or gradient colors as the background.
	<b>Pre-installed</b>	Choose backgrounds that come pre-installed with Whiteboard.
	<b>myViewBoard Originals</b>	Display original content created by myViewBoard.
	<b>Local Hard Drive</b>	Use images from the local hard drive.



## vCast

Working with ViewBoard® Cast software (vCast, vCast Pro, and vCastSender), the vCast application will allow the ViewBoard to receive laptop screens (Windows/Mac/Chrome) and mobile (iOS/Android) users' screens, photos, videos, annotations, and camera(s) that are using the vCastSender application.

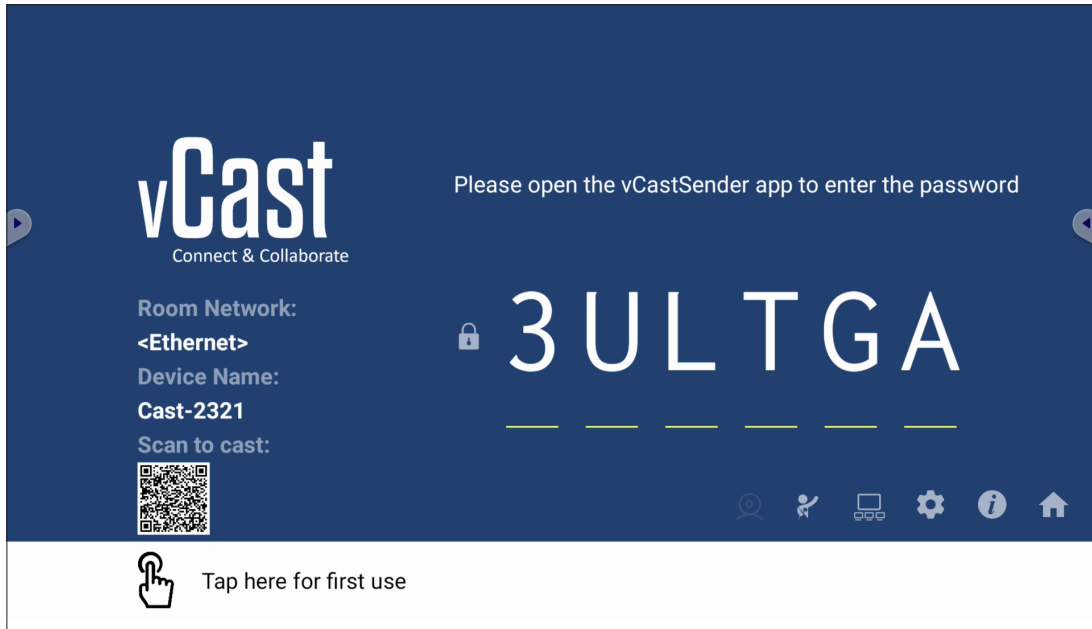

## Network Information

- ViewBoard® Cast software, laptops, and mobile devices can connect to both the same subnet and cross subnet by entering the on-screen PIN code.
- Connected devices will show up under **Device List** on the same subnet connection.
- If the device does not show up under **Device List**, users will need to key-in the on-screen PIN code.
- **Ports:**
  - » TCP 56789, 25123, 8121 & 8000 (Controlling message port & client device audio transfer)
  - » TCP 8600 (BYOM)
  - » TCP 53000 (Request share screen)
  - » TCP 52020 (Reverse control)
  - » TCP 52025 (Reverse control for ViewBoard Cast Button)
  - » TCP 52030 (Status sync)
  - » UDP 48689, 25123 (Device searching and broadcast & client device audio transfer)
  - » UDP 5353 (Multicast search device protocol)
- **Port and DNS for Activation:**
  - » Port: 443
  - » DNS: <https://vcastactivate.viewsonic.com>
- **OTA Service**
  - » Server Port: TCP 443
  - » Server FQDN Name: <https://vcastupdate.viewsonic.com>

## Display Group Settings

To adjust the Display Group Settings, select the Display Group icon (🖥️) located in the lower-right corner of the screen.

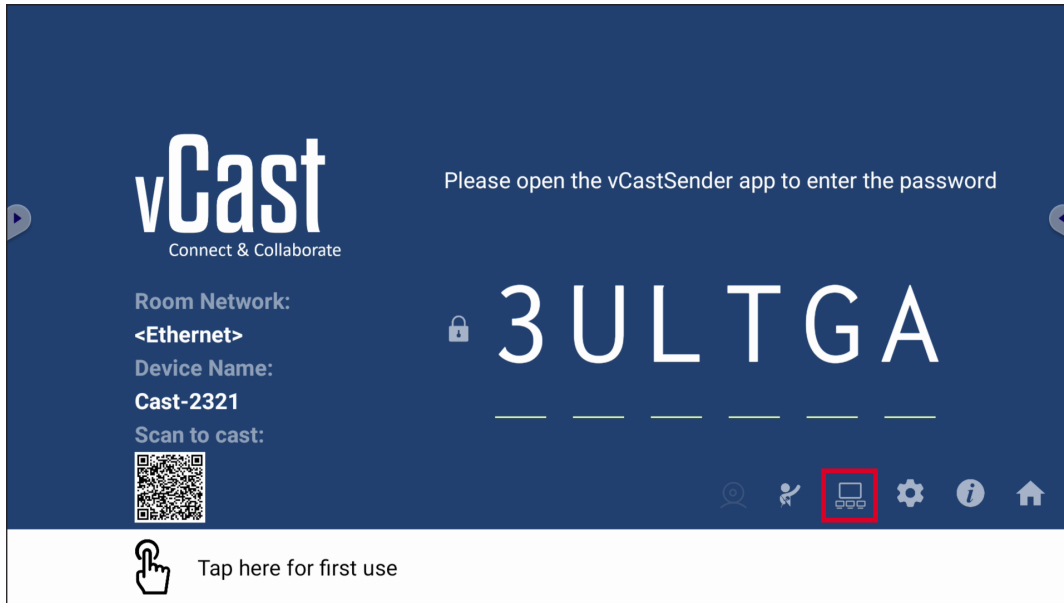

1. Toggle the “Turn On/Off Display Group” ON to enable the Display Group feature.

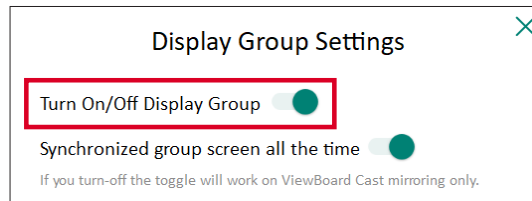

**NOTE:** Other preinstalled ViewBoard Cast devices in the same network will be listed.

2. Select the devices you want to join the display group and select **OK** to save the settings.

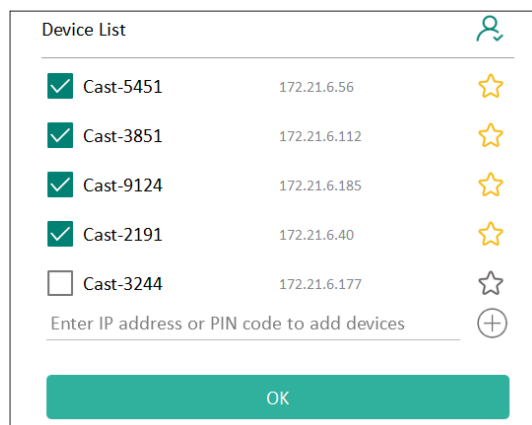

**NOTE:**

- If the devices you want to group are not listed, you can enter their respective IP address or connecting PIN code.
- The Display Group maximum device limit is six devices.

3. If you frequently connect to the same device, you can select the Star icon (★) next to the device to add it to your frequently connected devices list, “My List of Devices in Group”, for easier Display Group setup and management.

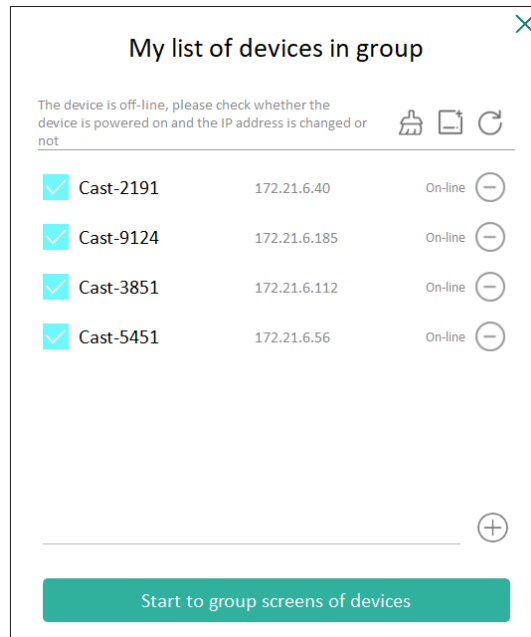

## Synchronized Group Screen All the Time

When the “Synchronized group screen all the time” function is toggled ON, it will display a synchronized group screen continuously. If it is toggled OFF, it will work on vCast mirroring only.

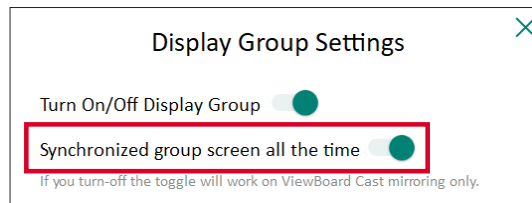

**NOTE:** Select the devices to group first, then toggle the “Synchronized group screen all the time” function ON to avoid interruption.

## Share a Screen to the Display Group (One to Many Casting)

After confirming the above settings, you can share your screen to the main display, then the grouped client devices will be synced up to your screen.



## Moderator Mode

Moderator Mode allows the moderator to take control of the devices connected to the ViewBoard or display. To enter Moderator Mode, select the Moderator Mode icon (👤) located in the lower-right corner of the screen.

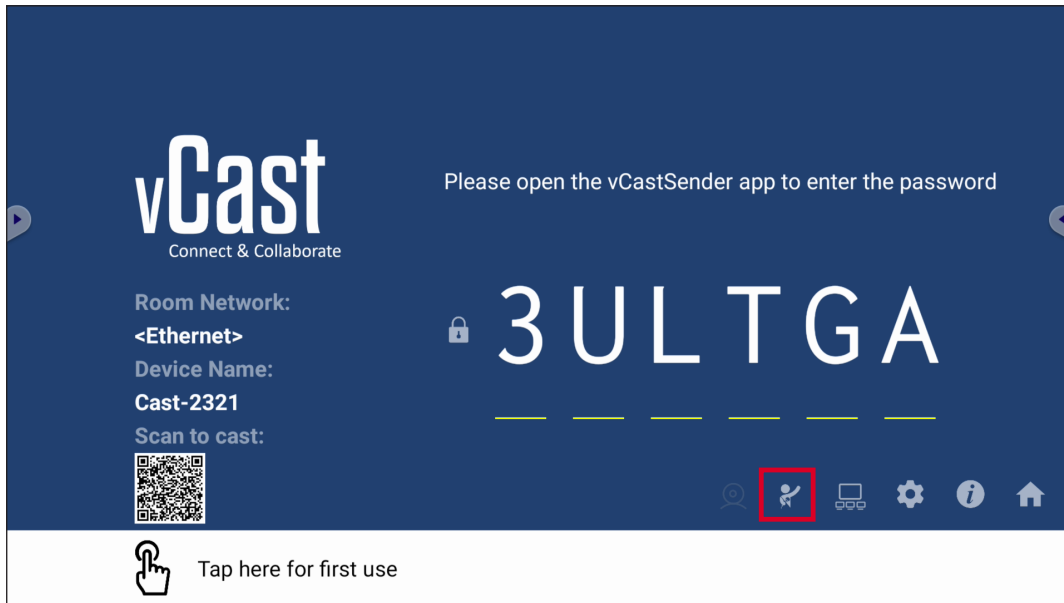

When enabled, the moderator can view a list of all connected screens in the left floating window and can preview each participant's screen and then select any of participant's screen and cast to the ViewBoard's or display's main screen for presentation. The moderator can also control each participant's screen, annotate on the ViewBoard or display, and remove unwanted participants by selecting the close icon (X).

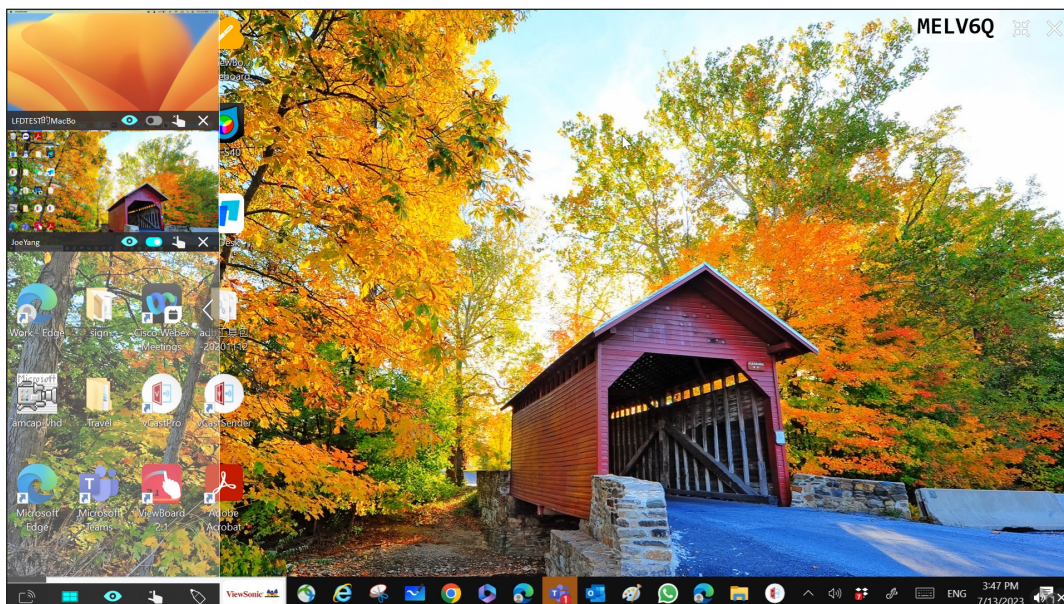

## Broadcast

When enabled, the ViewBoard's screen will be broadcasted to all of the participant's connected screens simultaneously. The participants can only view the presentation contents until the moderator disables the Broadcast function.

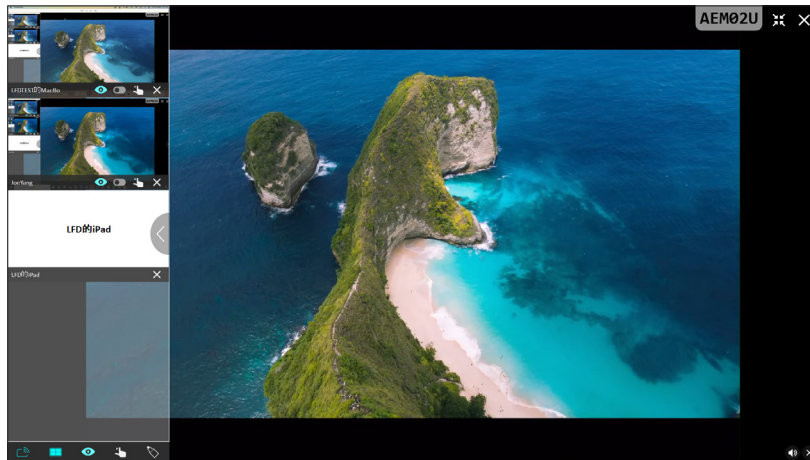

## Multiple Screen Sharing

By default, vCast is set to allow multiple screen sharing, but can also be set to single screen sharing. To do this, the moderator can select the Multiple Screen Sharing icon to switch to single screen sharing.

## Preview Screen

By default, vCast is set to let the moderator preview the participant's screen contents prior to sharing to the ViewBoard. Selecting the Preview Screen icon, the Moderator can switch to see the participant's name only.

## Touch

By default, participants can use touch for collaboration after connecting. The moderator can enable/disable the touch function of a participant by selecting the Touch icon in their window.

### NOTE:

- Moderator Mode is supported on all vCastSender and AirPlay devices, but mobile devices are limited to a "preview" function. Additionally, mobile Android devices cannot cast sound out.
- When you cast your Windows/Mac/Chrome screen to a ViewBoard or display, the selected full screen unit will not be broadcasted back to your device to avoid repetitive screen casting.
- The active presenter can touch each of the participant's screens to remotely control casting devices.
- The number of multi-screen presenters on-screen depends on your Windows CPU processor performance and router specifications.

## Casting from Windows, MacBook, and Chrome Devices

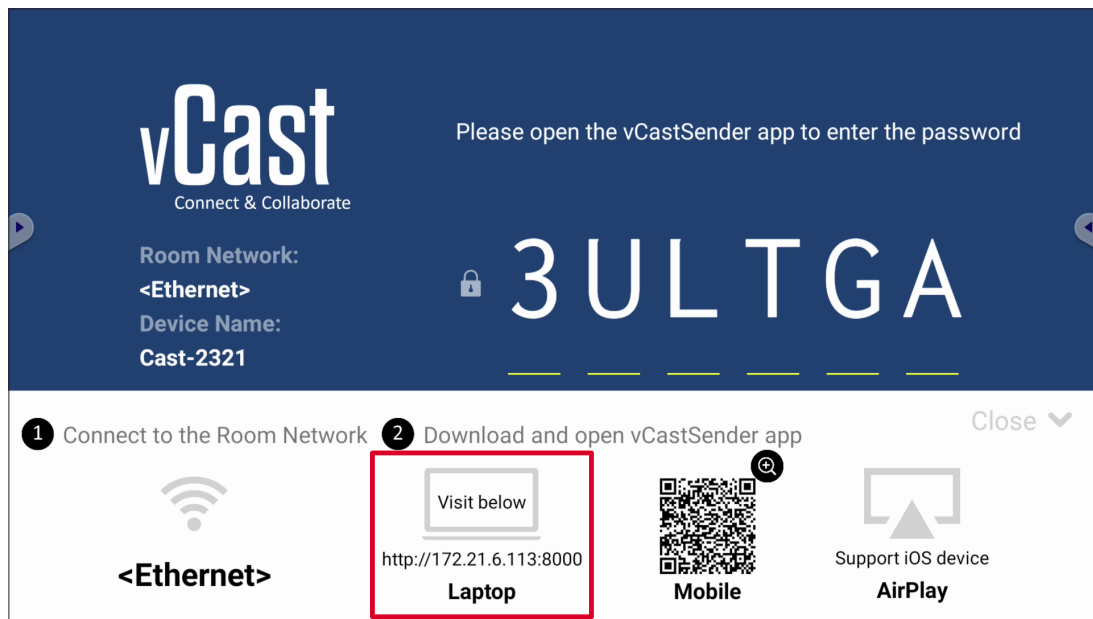

1. Ensure the client device (e.g., laptop) is connected to the same network as the ViewBoard.

**NOTE:** The network name can be found under **Room Network**.

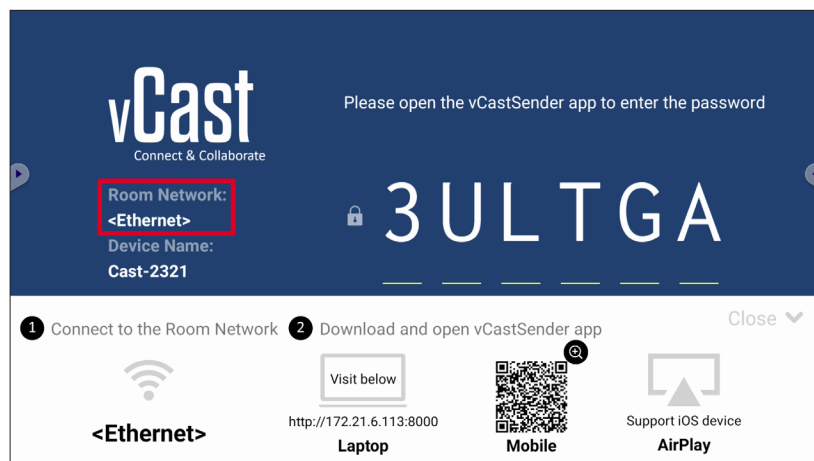

2. On the client device, visit the address that is shown on the ViewBoard to download and install the vCastSender application.
3. After installing, launch the vCastSender application.



4. To connect to the ViewBoard, input the PIN code and click OK.

**NOTE:** The PIN code can be found as highlighted below:

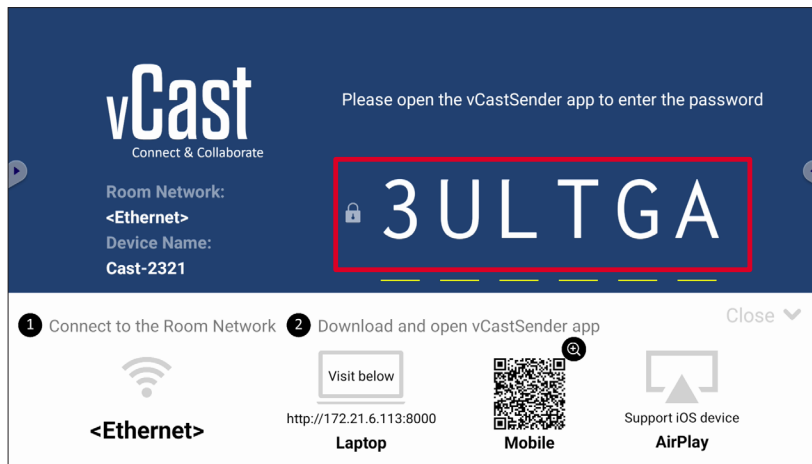

5. Additionally, you can connect to the ViewBoard by clicking **Device List** then the **Device Name** listed.

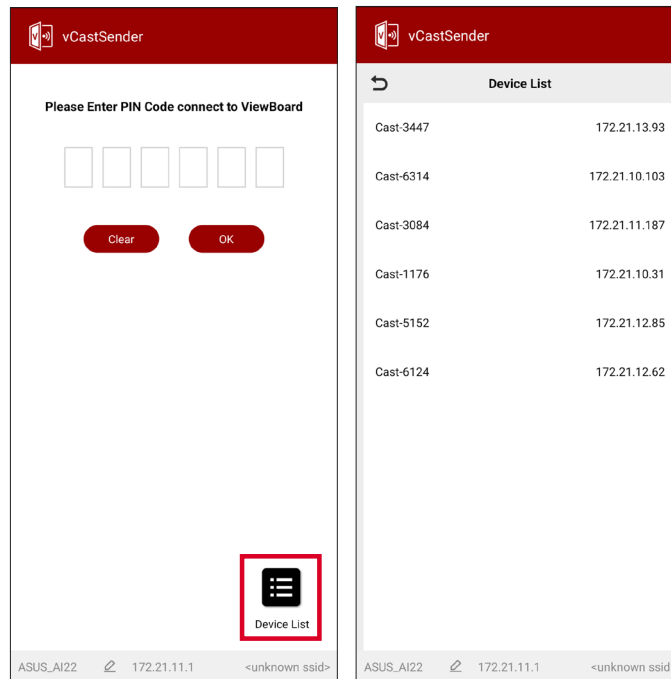

**NOTE:** The **Device Name** can be found as highlighted below:

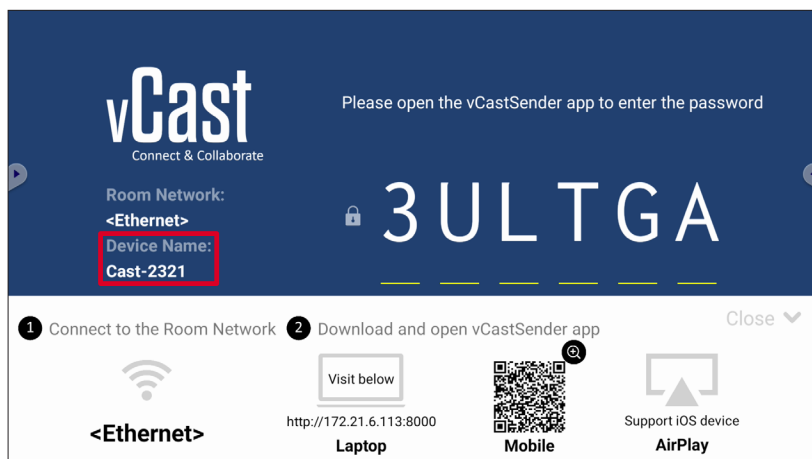

# Casting from Android Devices

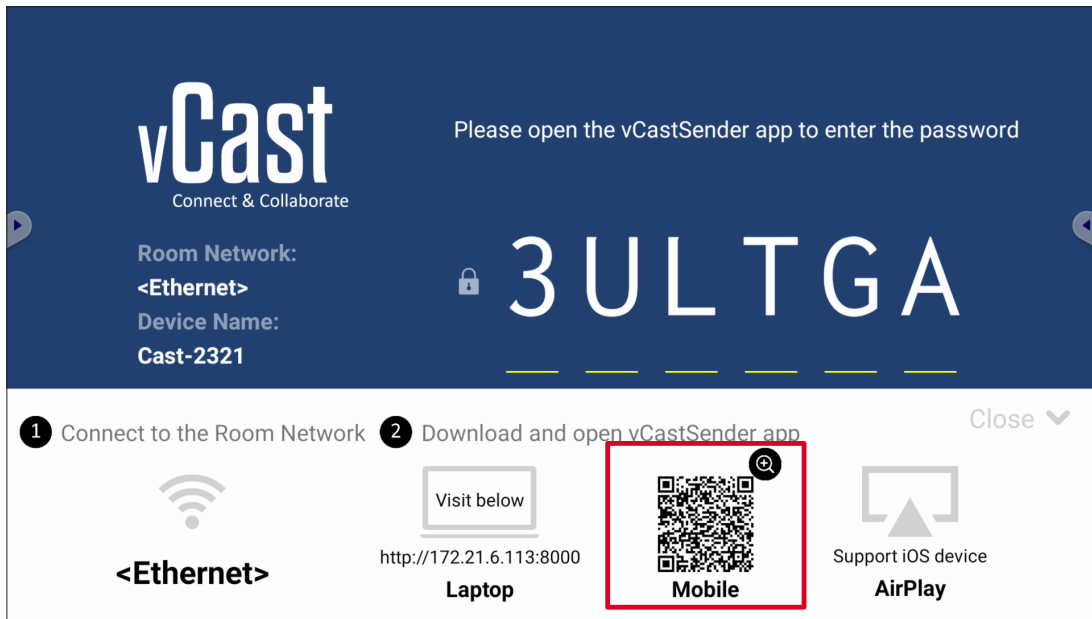

1. Ensure the client device (e.g., Android phone or tablet) is connected to the same network as the ViewBoard.

**NOTE:** The network name can be found under **Room Network**.

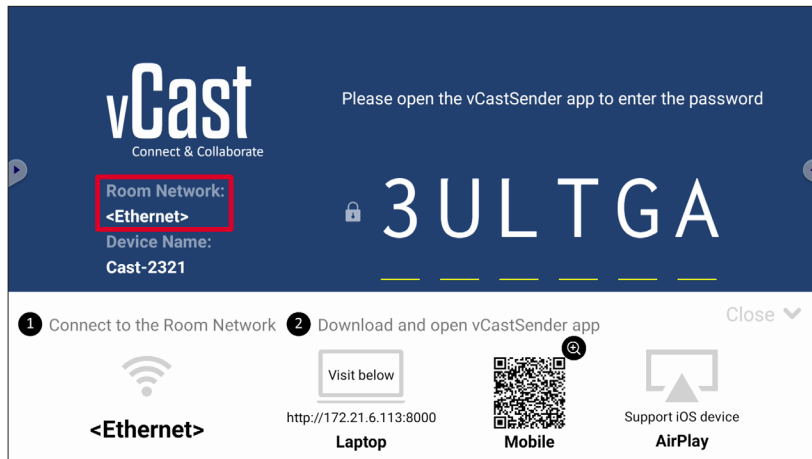

2. On the Android client device, scan the QR code shown on the ViewBoard to directly download the vCastSender application, or download the application from the Google Play Store.

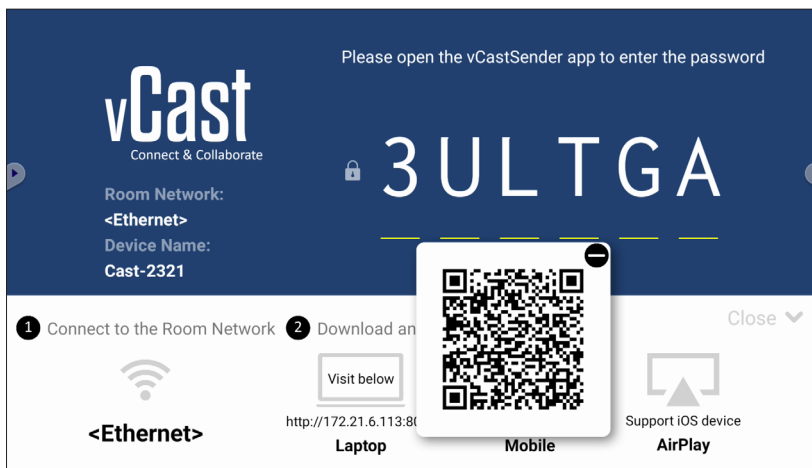

3. After installing, launch the vCastSender application.

4. To connect to the ViewBoard, input the PIN code and select **OK**.

**NOTE:** The **PIN code** can be found as highlighted below:

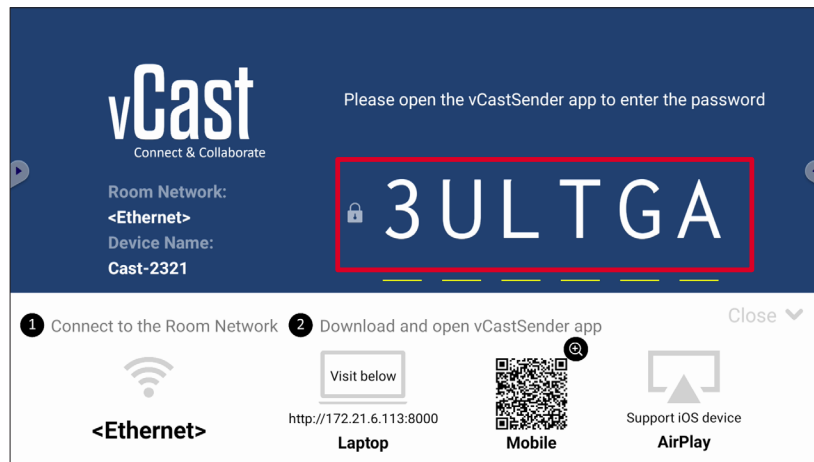

5. You can also connect to the ViewBoard by selecting **Device List** then the **Device Name** listed.

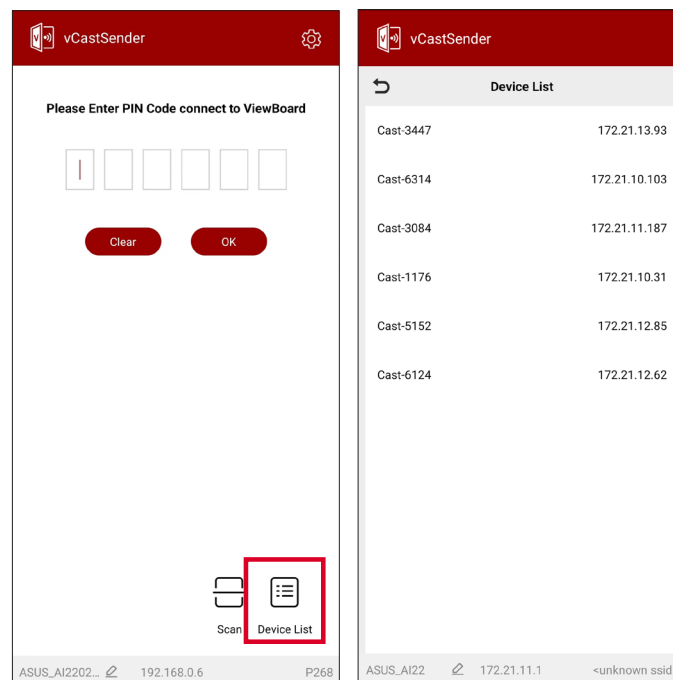

**NOTE:** The **Device Name** can be found as highlighted below:

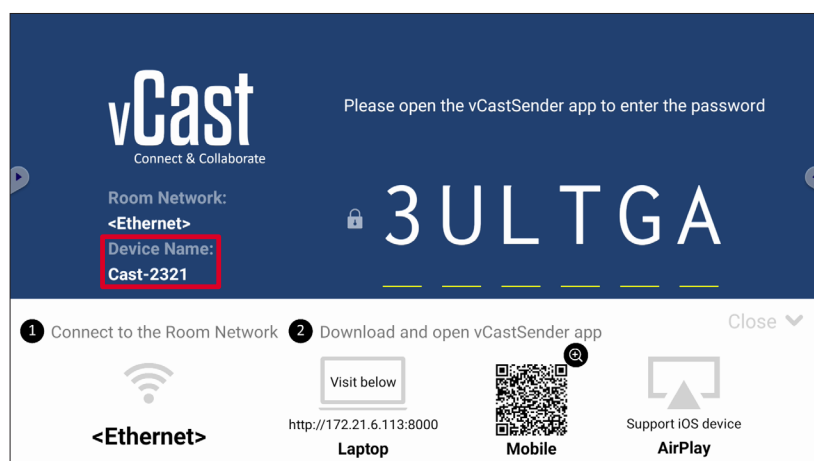

6. Additionally, you can connect to the ViewBoard or by selecting **Scan** then placing the on-screen QR code into the box to automatically connect.

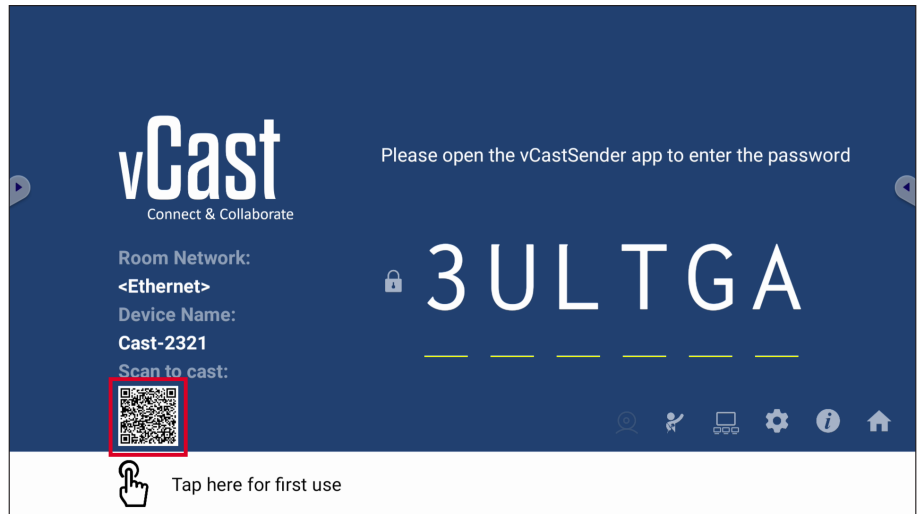
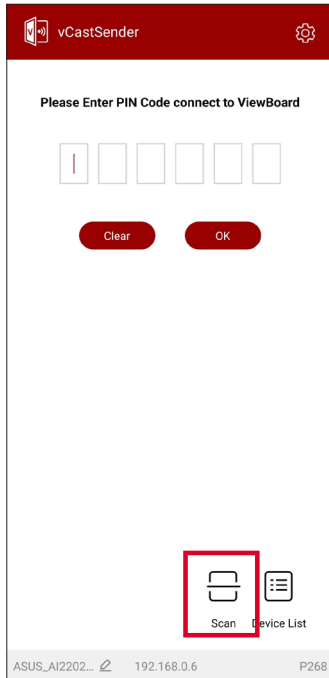

## Casting from Apple iOS Devices

Apple AirPlay® is compatible with vCast for screen mirroring and content streaming under the same subnet environment only. An “AirPlay Password” will be generated on-screen for connection when using AirPlay to cast to a ViewBoard.

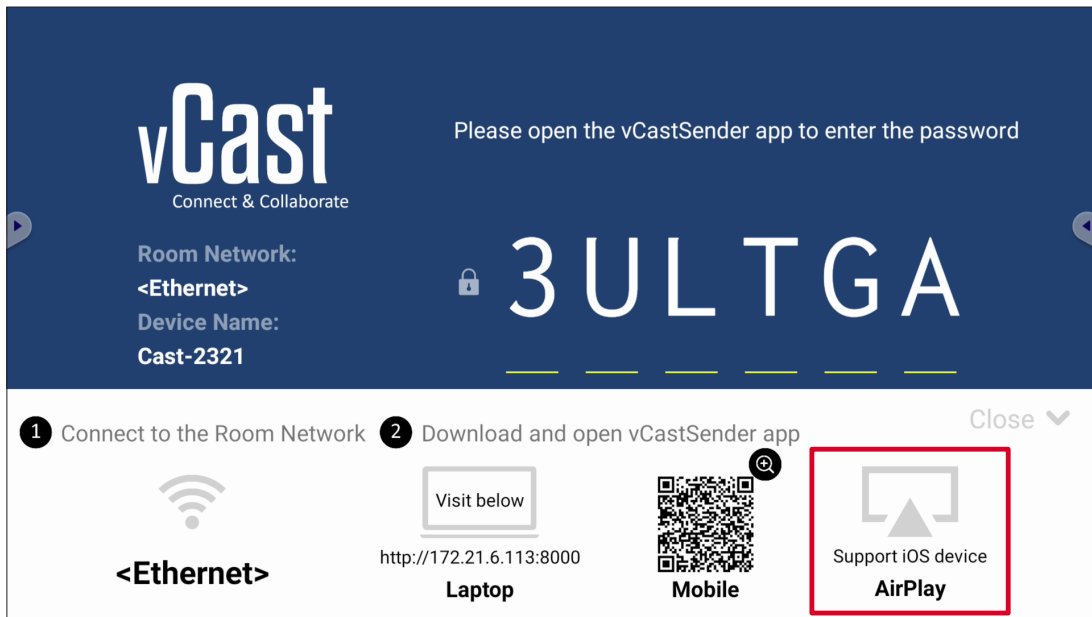

1. Ensure the client device (e.g., iPhone or iPad) is connected to the same network as the ViewBoard.

**NOTE:** The network name can be found under **Room Network**.

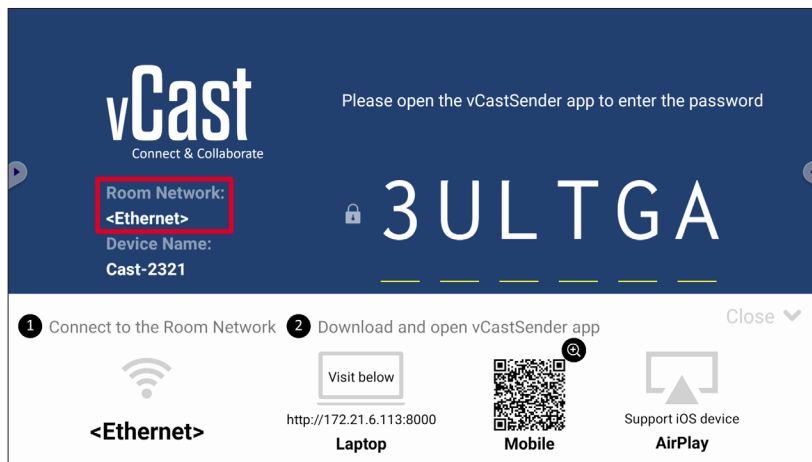

2. On the iOS client device, directly open AirPlay and select the **Device Name** of the ViewBoard to connect.

**NOTE:** The **Device Name** can be found as highlighted below:

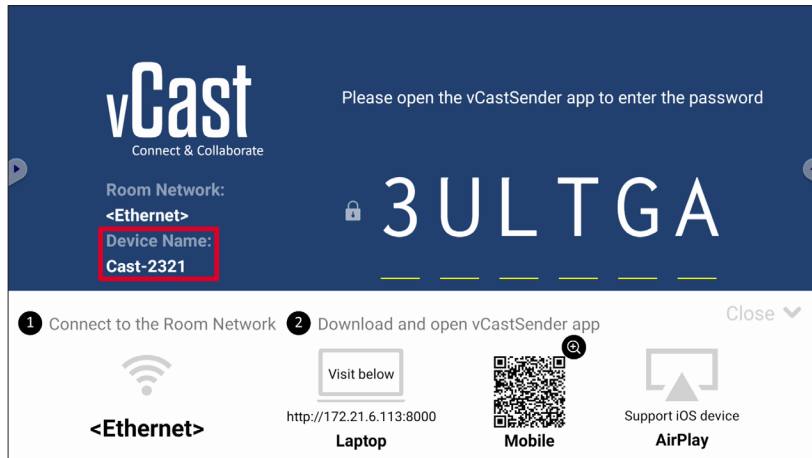

3. Input the generated on-screen **AirPlay Password** on the client device to connect.

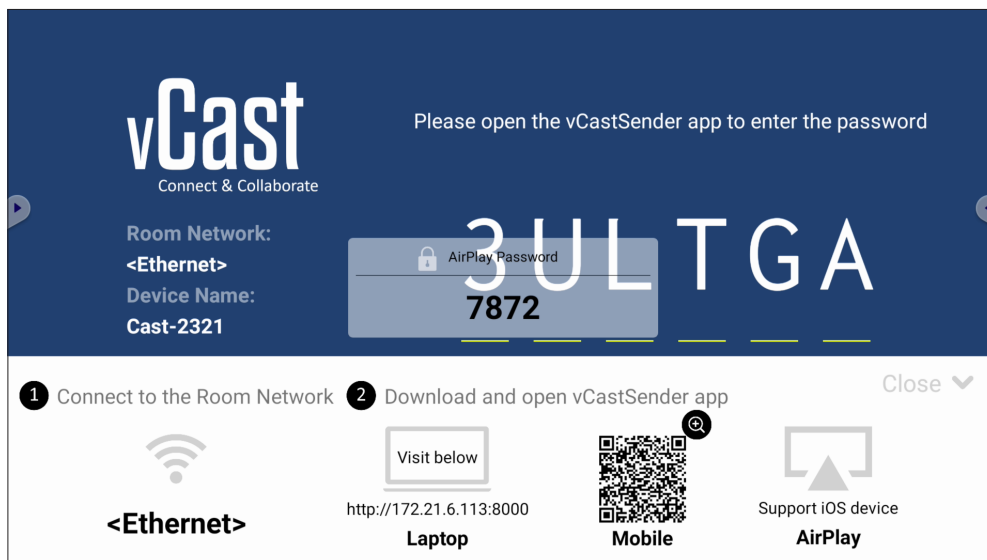

**NOTE:** In a cross subnet environment, please download and connect with the vCastSender iOS application from the Apple App Store.



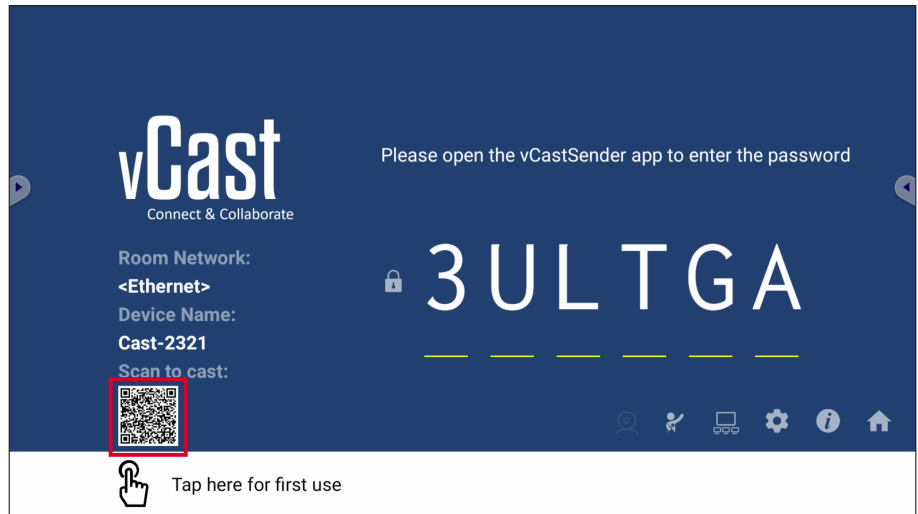
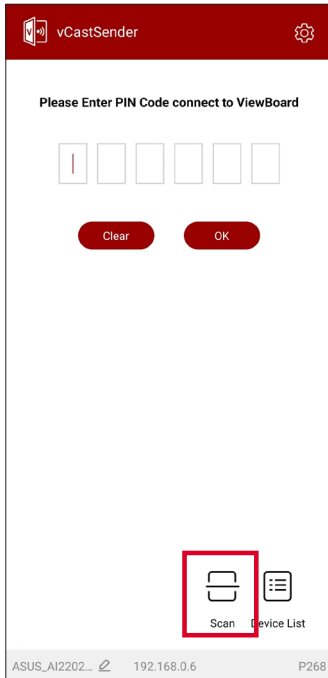



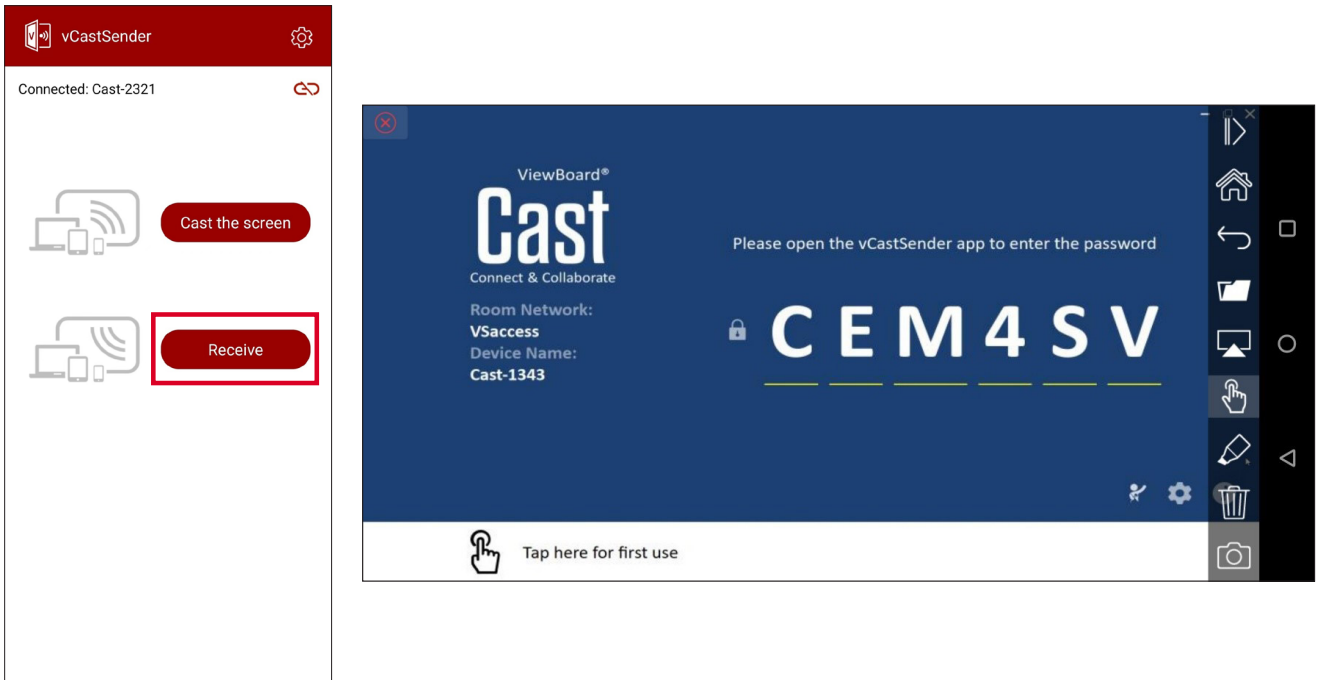

4. You can also connect to the ViewBoard by selecting **Scan** then placing the on-screen QR code into the box to automatically connect.



## Connecting to a ViewBoard from a Mobile Device

Once connected select **Receive**. The ViewBoard will appear on the mobile device with an on-screen toolbar. Users can interact with the ViewBoard with annotations, file sharing, etc.



Item	Description
	<b>Toggle</b> Hide or display the toolbar.
	<b>Home</b> Return to the Home interface.
	<b>Return</b> Return to the previous operation.
	<b>Folder</b> View or open the mobile device's files.
	<b>Share</b> Cast the mobile device's screen to the connected ViewBoard or display.
	<b>Touch</b> Remotely control the connected ViewBoard or display.
	<b>Annotate</b> Make annotations, and adjust the pen color.
	<b>Clear</b> Clear everything on screen.
	<b>Camera</b> Send camera images to the connected ViewBoard or display.



## Casting with Chromecast

vCast supports native Chromecast screen sharing via the Chrome browser casting when the Chromecast feature is enabled.

**NOTE:** Chromecast does not support password protection or multiple-screen casting.

1. Ensure the client device (e.g., laptop) is connected to the same network as the ViewBoard.

**NOTE:** The network name can be found under **Room Network**.

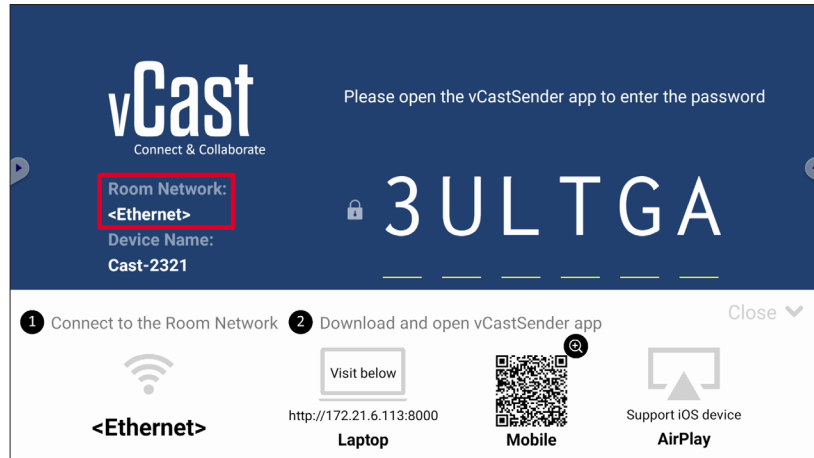

2. Ensure the **Chromecast Enable** checkbox is selected in the vCast settings.

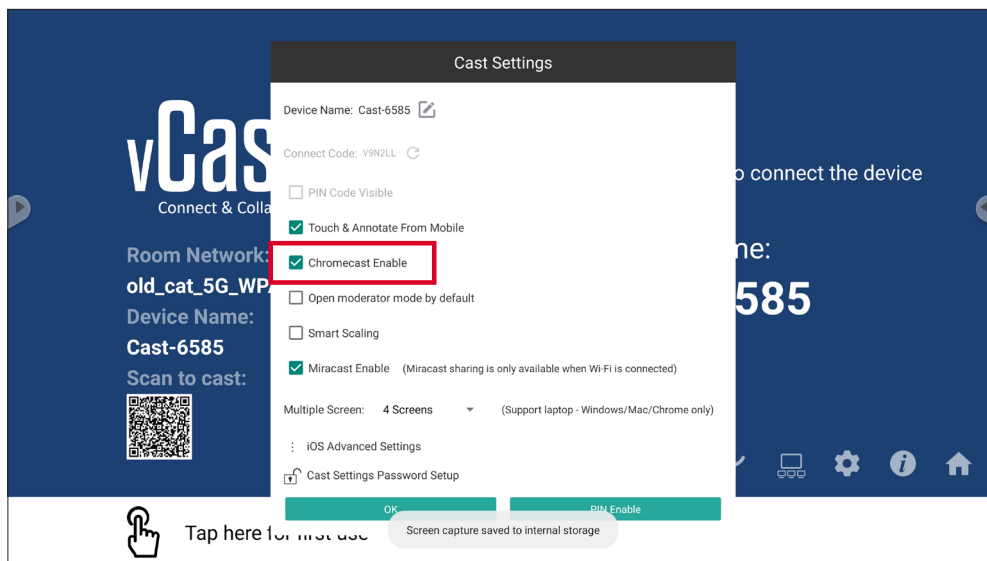

3. In the Chrome browser, go to: **Settings > Save and share > Cast...** > Select the screen to cast to.

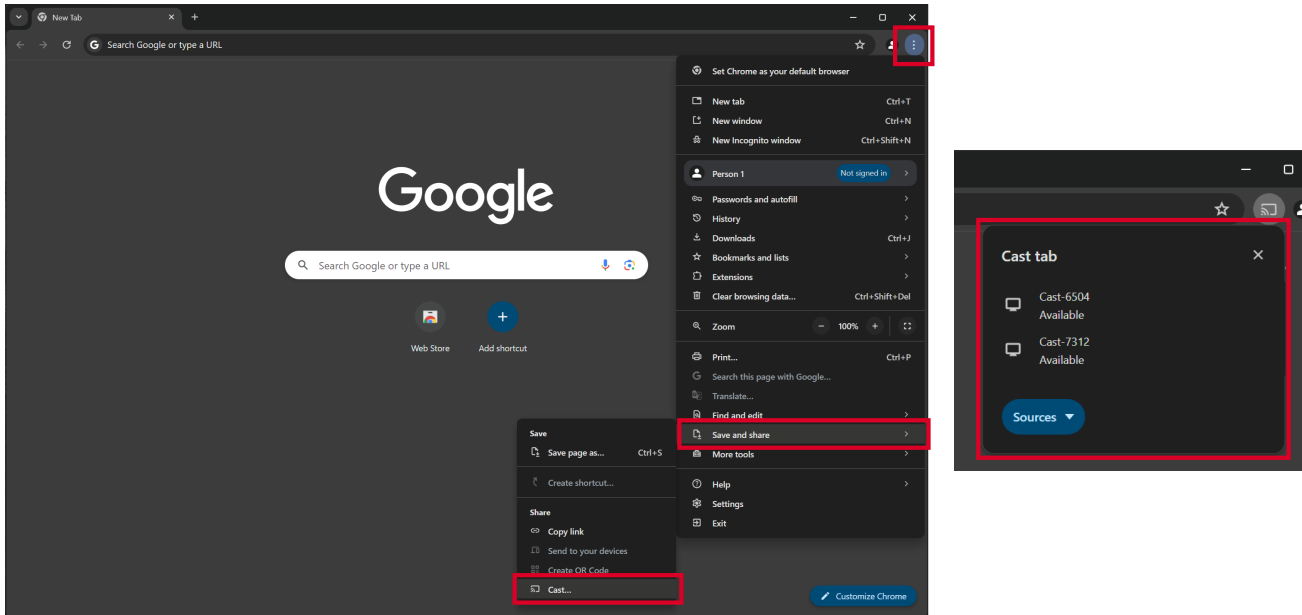

## Casting with Miracast

vCast supports native Miracast to cast content from Windows and Android devices to a ViewBoard when the Miracast feature is enabled.

### NOTE:

- Miracast does not support password protection or multiple-screen casting.
- Miracast sharing is only available over Wi-Fi.
- Miracast will automatically turn off after being idle for one hour.

1. Ensure the client device (e.g., laptop) is connected to the same network as the ViewBoard.

**NOTE:** The network name can be found under **Room Network**.

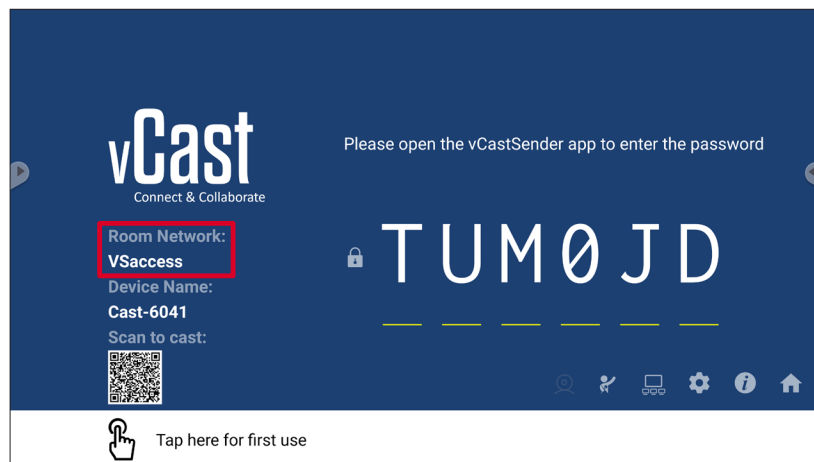

2. Ensure the **Miracast Enable** checkbox is selected in the vCast settings.

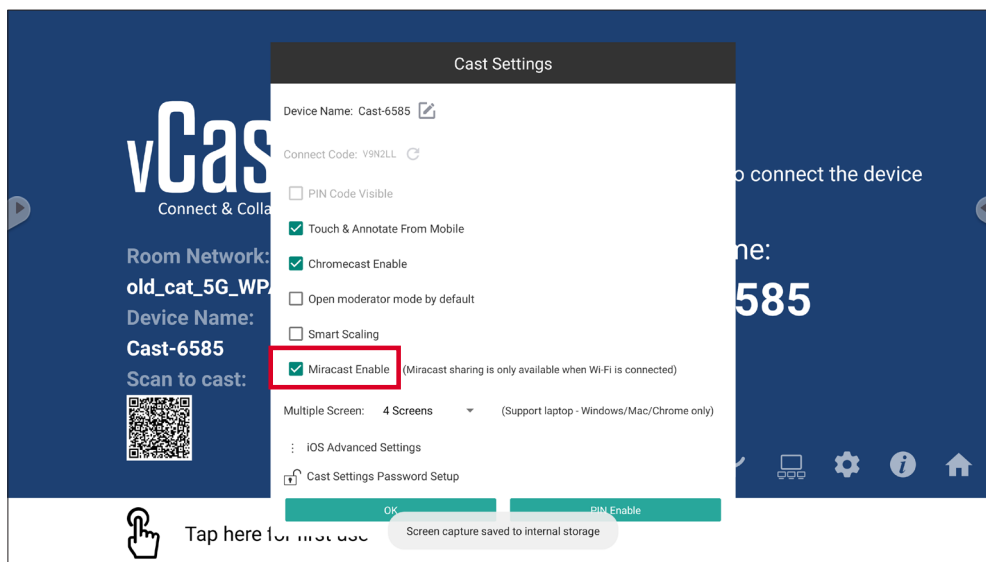

**3.** Please follow the below steps to cast:

For Windows devices:

**1.** On the Windows device, press Win + K and select the display to cast to.

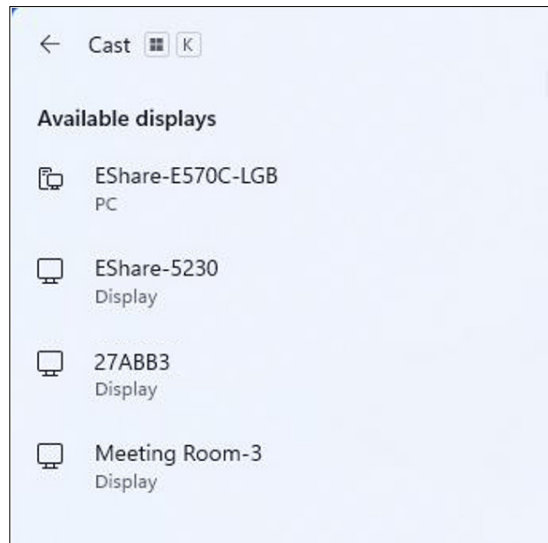

**2.** Select the checkbox “Allow mouse, keyboard, touch, and pen input from the device” to enable the touch feedback feature.

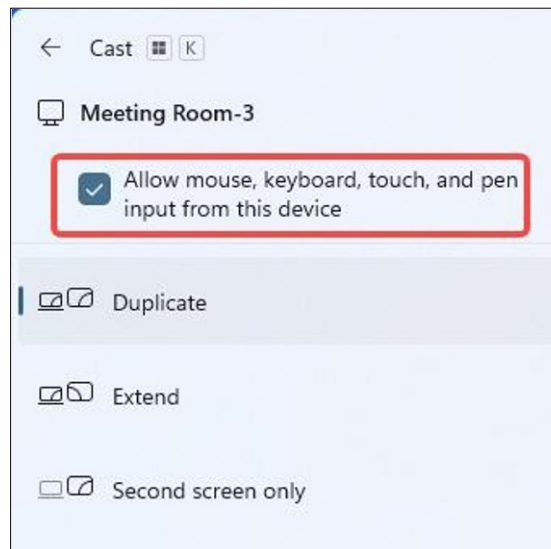

For Android devices:

On the Android device, directly select Cast/Smart View/Wireless Projection then select the display to cast to.

# Other Default Applications

## Chromium

Web browser for surfing the Internet.

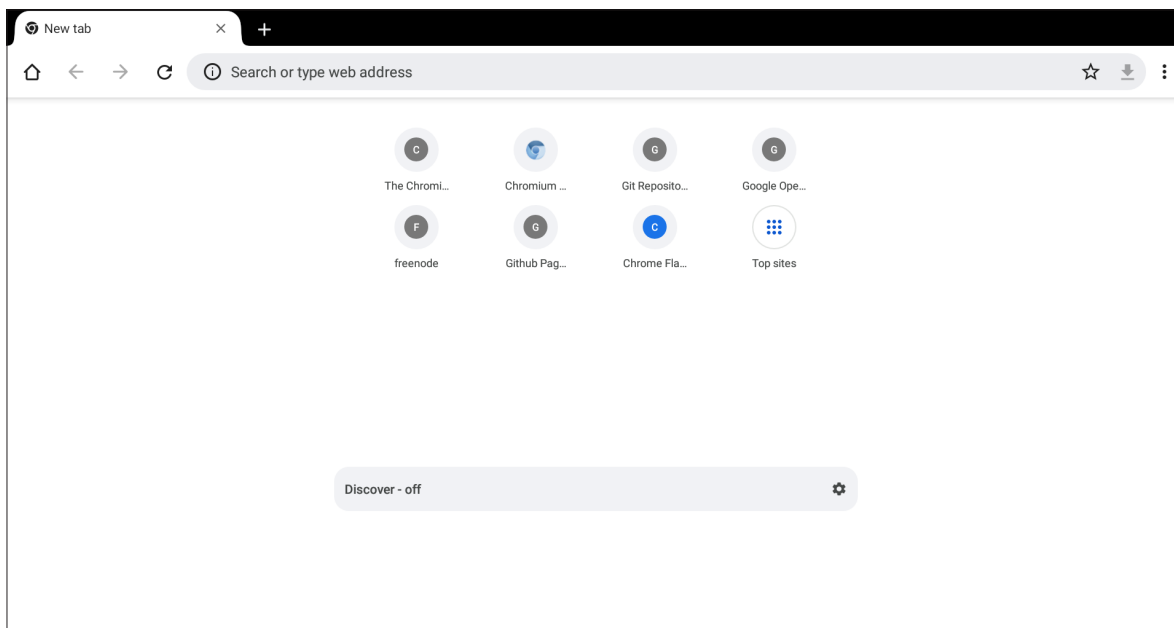



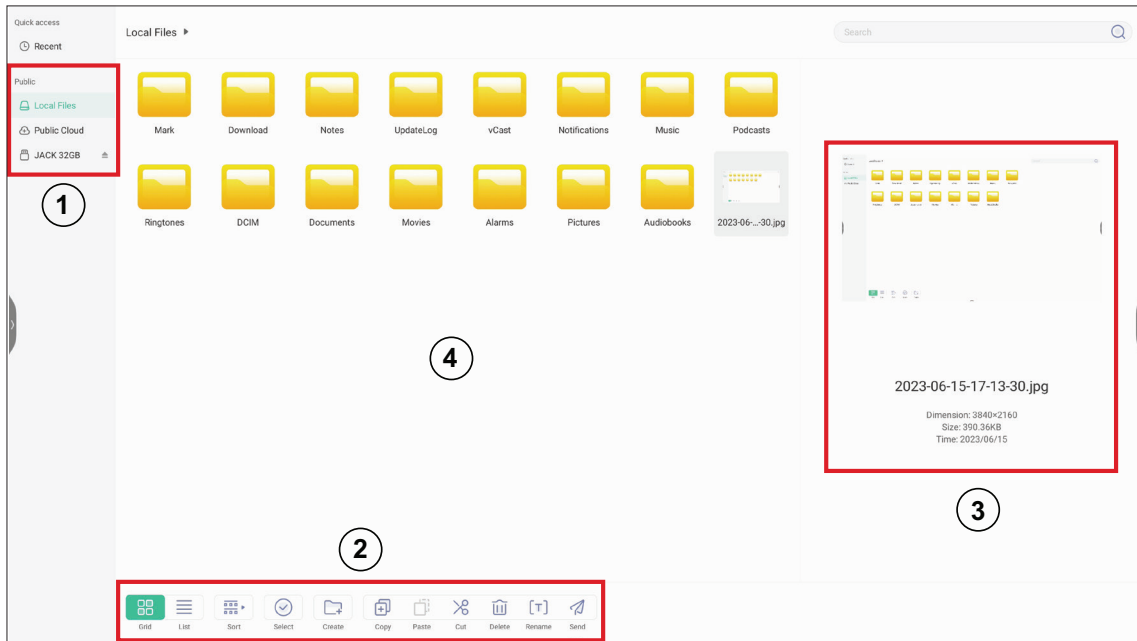







# Folders



## 1. Storage Device Display

Select the appropriate storage device.

## 2. Icons

Item	Description
	<b>Grid</b> Display files by thumbnail view
	<b>List</b> Display files by list view
	<b>Sort</b> Sort the files
	<b>Select</b> Select a file
	<b>Create</b> Create a new folder
	<b>Copy</b> Copy a file
	<b>Paste</b> Paste a file
	<b>Cut</b> Cut a file
	<b>Delete</b> Delete a file
	<b>Rename</b> Rename a file
	<b>Send</b> Share a file

### **3. File Information**

Preview the file, show the file's name, size, resolution, and creation date.

### **4. Main Display Area**

Display files of corresponding type.

# OfficeSuite

Create, edit, and view Documents, Spreadsheets, Presentations, and PDFs.

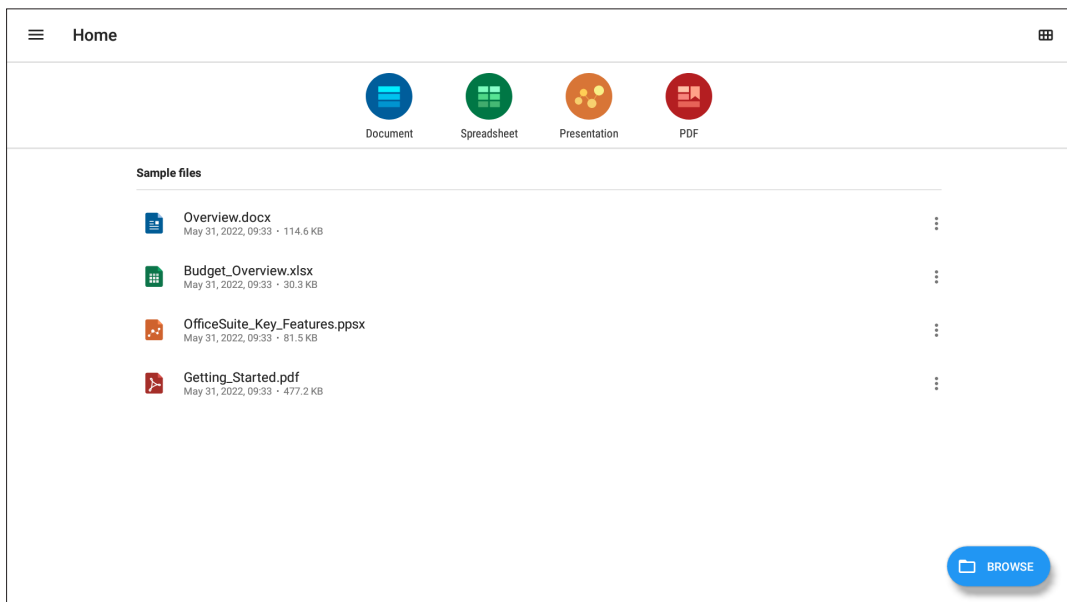



## PIP (Picture-in-Picture)

Split the screen into two parts, a main window and an inset window.

**NOTE:** PIP only works between an Android application (browser, media player, vCast) and an external source.

- To open PIP, select: **All Apps > PIP.**

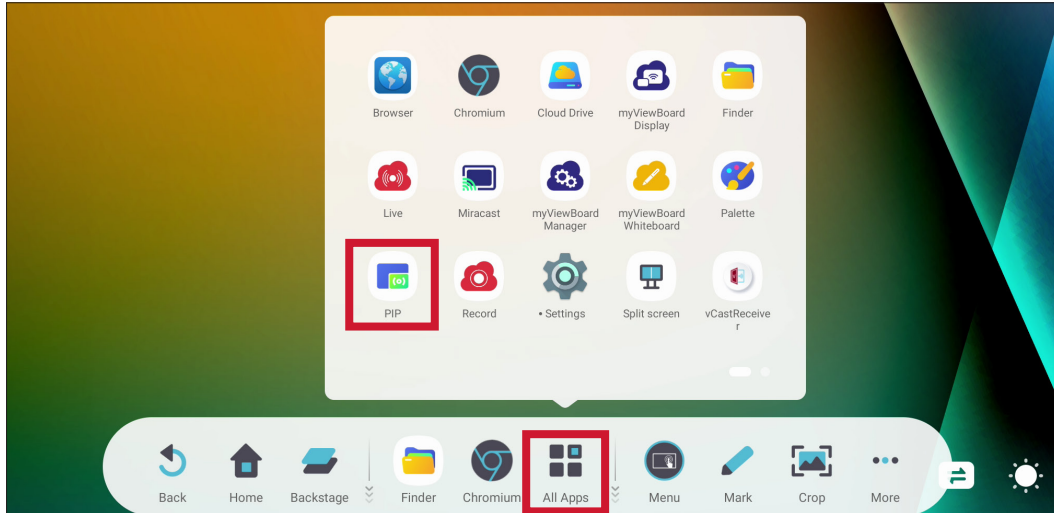

- To change the position of the inset window, select, hold and drag the window to the preferred location.

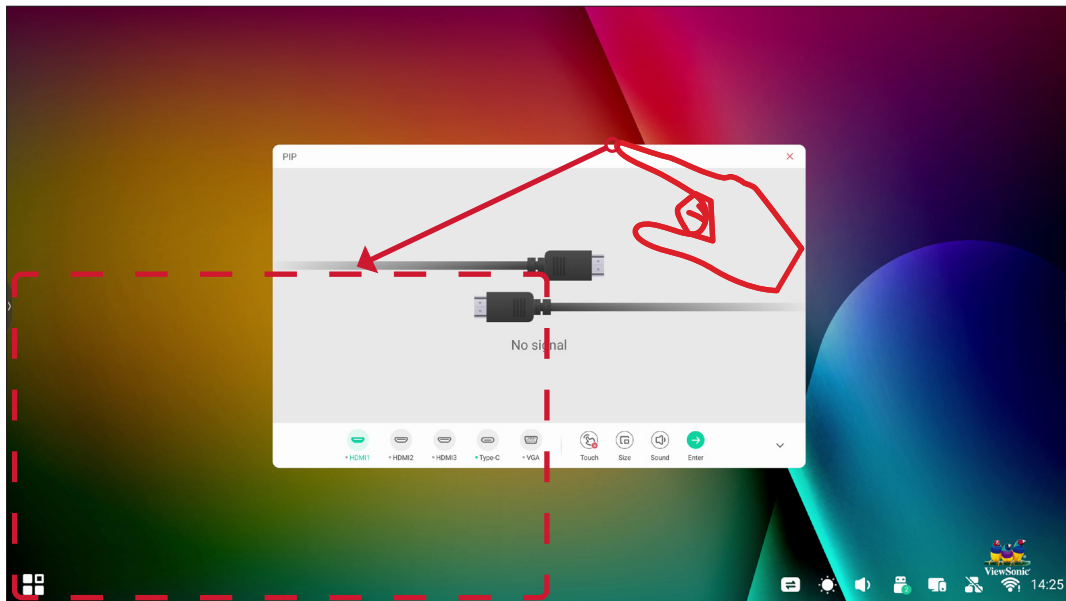

- To adjust the size of the inset window, select **Size.**

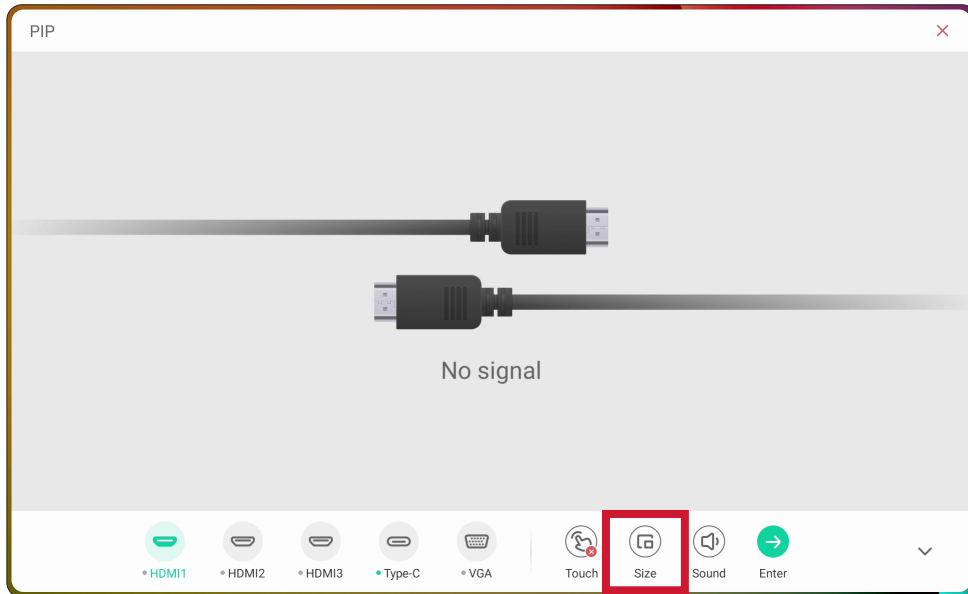

- To change PIP input source select **HDMI 1**, **HDMI 2**, **HDMI 3**, **Type C**, or **VGA**.

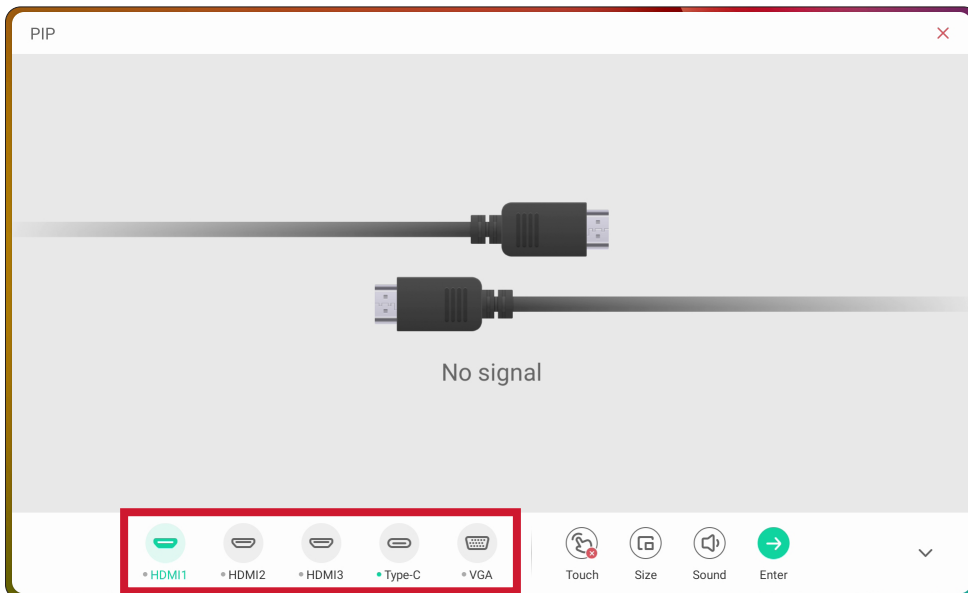

- For touch control of the connected external device, select **Touch**.

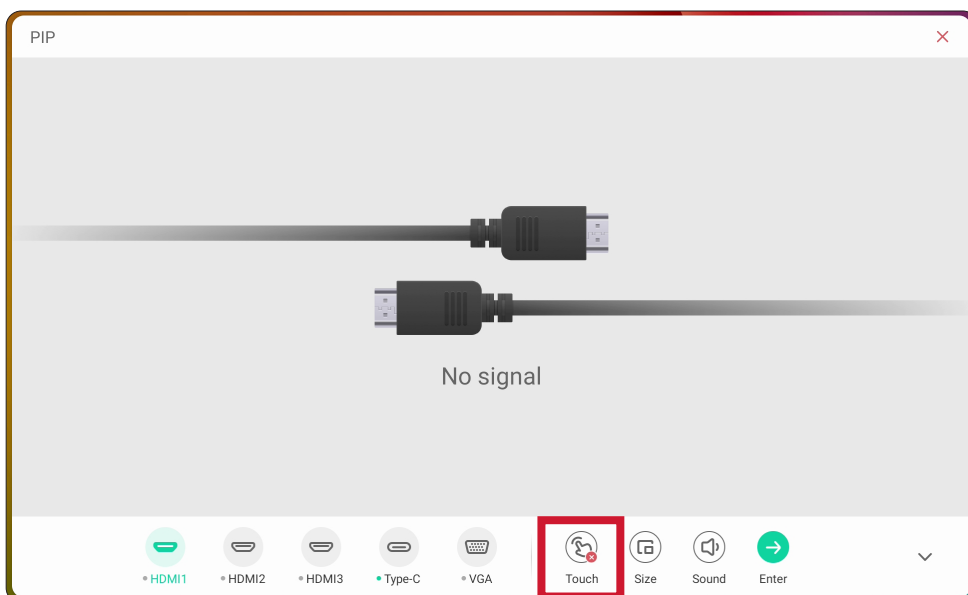

- To control the connected external device's volume, select **Sound**.

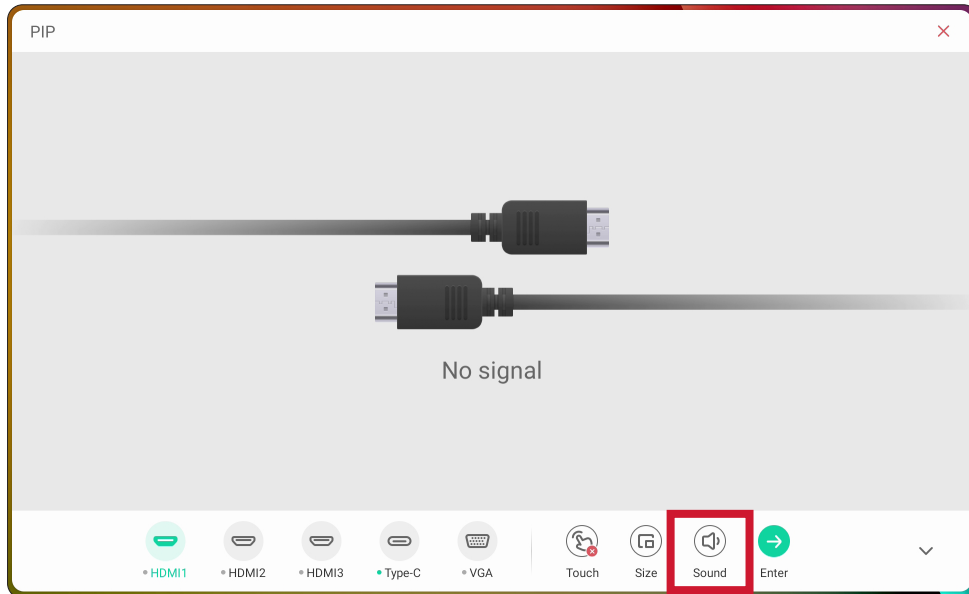

- Select **Enter** to switch to the PIP input source.

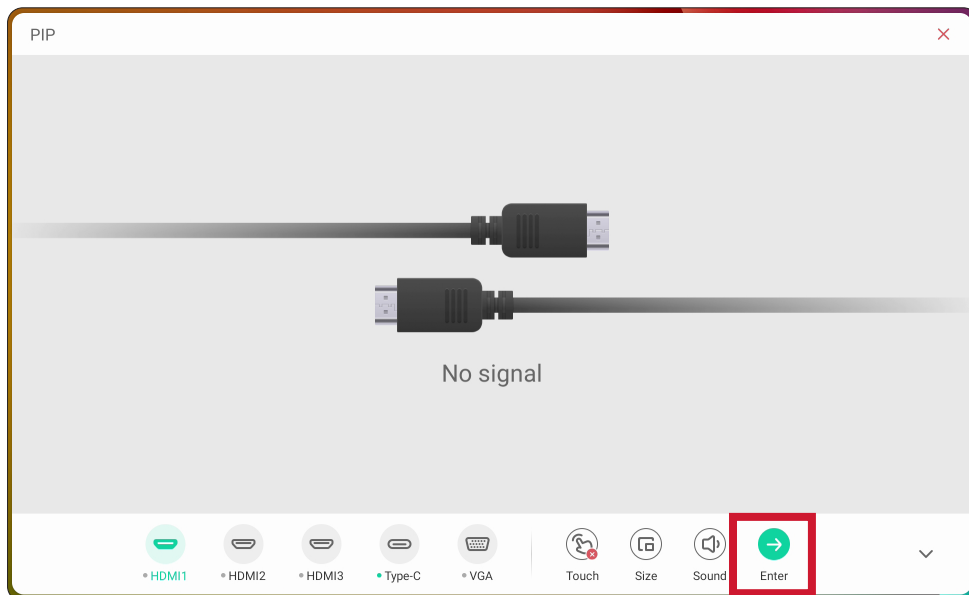

## Screen Lock

Set a screen lock password and enable screen lock.

**NOTE:** If the user forgets the password, use the remote control and press **INPUT-0-2-1-4** to restore the password to default.

To set a screen lock password:

**1.** Go to: **Settings > Display > Password for screen lock**, or select the Screen Lock icon in the applications list.

**NOTE:** If you select the Screen Lock icon and no password has been set, the below prompt will appear:

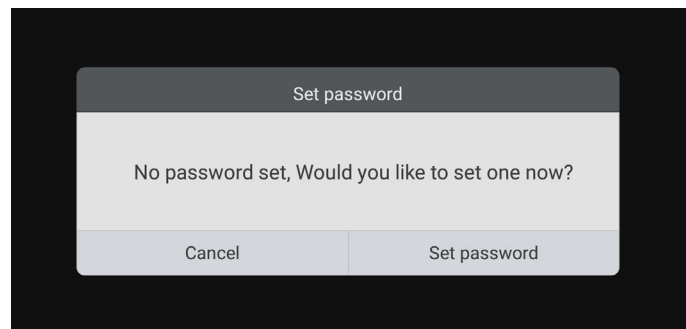

**2.** Select **Set Password**, and input a new four (4) digit password. Then select **OK**.

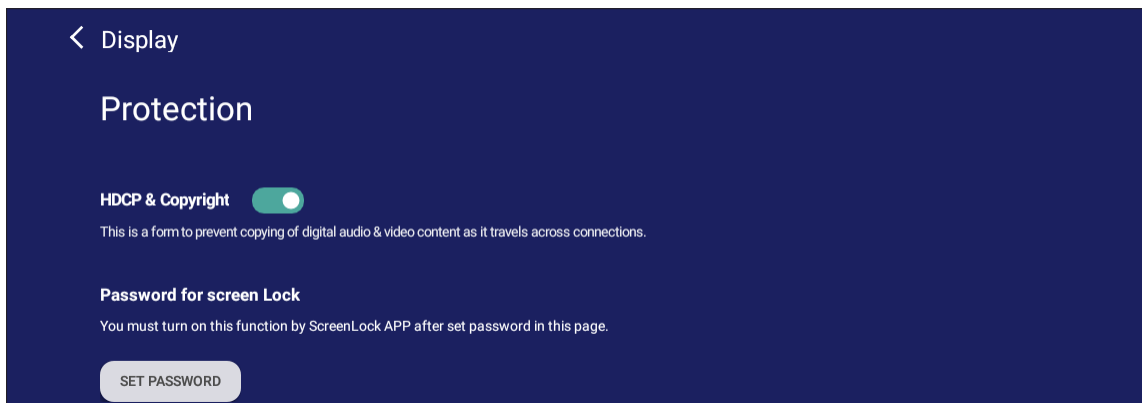

**3.** Now when selecting the Screen Lock icon, the screen will be locked.

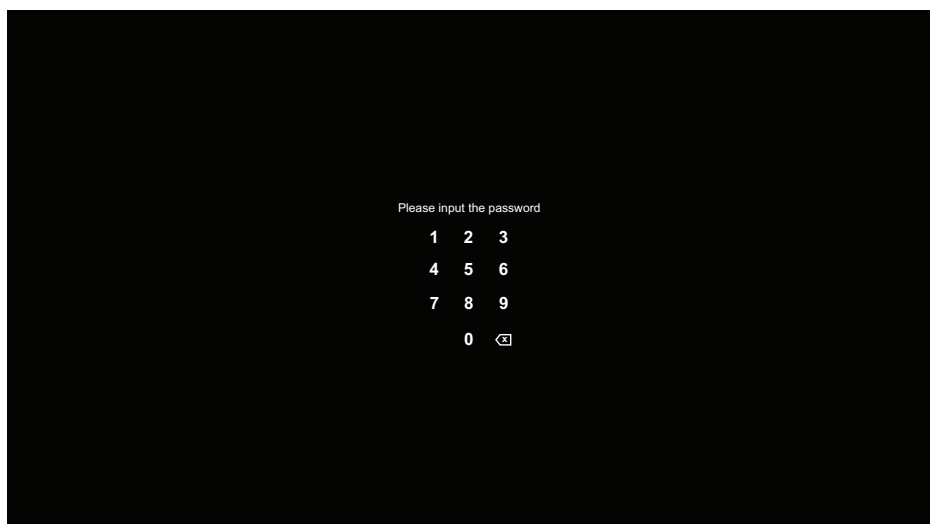

## vSweeper

Clear unnecessary data and unwanted files.

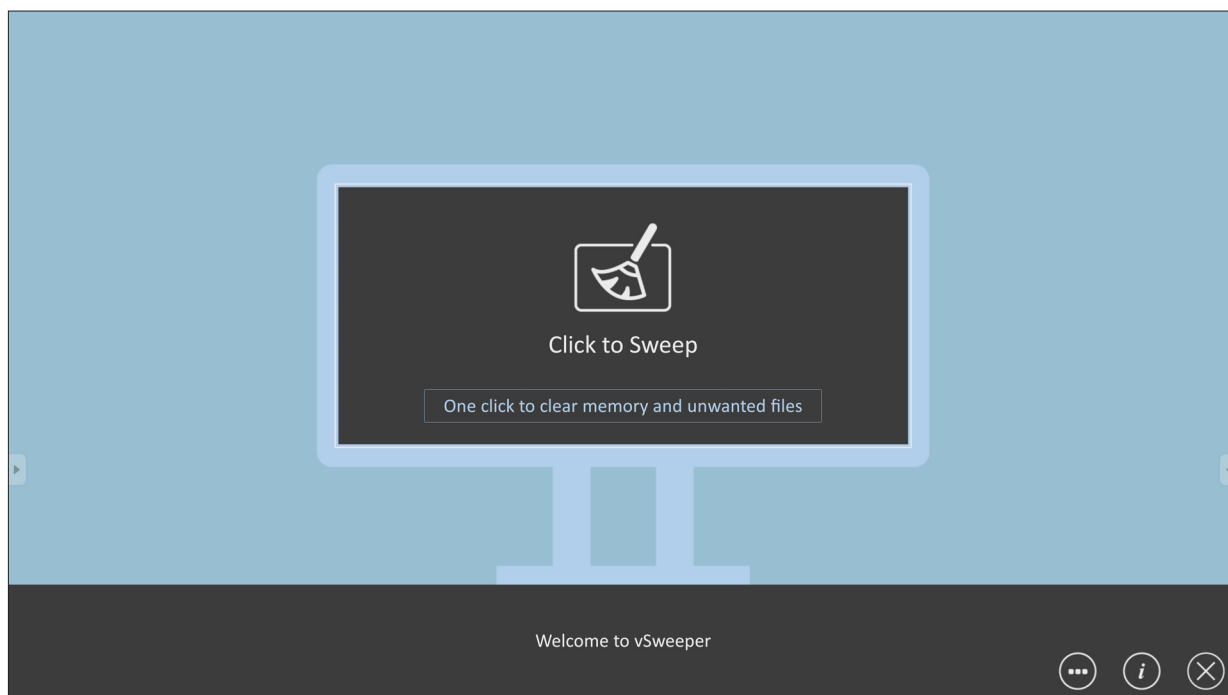

Advanced Settings can also be customized to the user's needs.

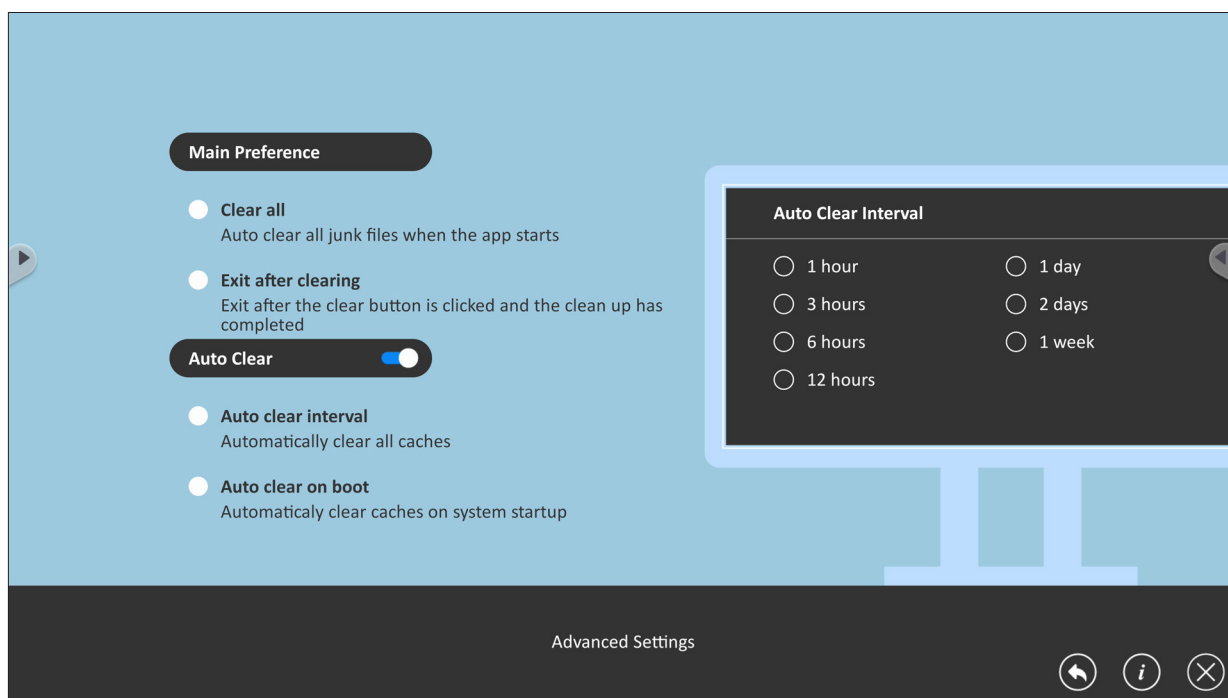

# RS-232 Protocol

This document describes the hardware interface spec and software protocols of RS-232 interface communication between ViewSonic LFD and PC or other control units with RS-232 protocol.

The protocol contains three command sections:

- Set-Function
- Get-Function
- Remote control pass-through mode

**NOTE:** Below, “PC” represents all the control units that can send or receive the RS-232 protocol command.

## Description

### RS-232 Hardware Specification

ViewSonic LFD communication port on the rear side:

1. Connector type: DSUB 9-Pin Male (or 3.5 mm barrel connector)
2. Use of crossover (null modem) cable for connection
3. Pin Assignment:

Female DSUB 9-Pin

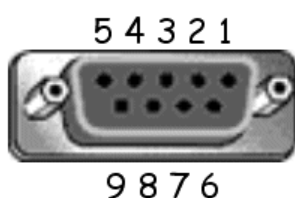

Male DSUB 9-Pin

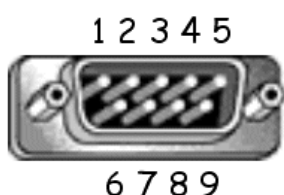

3.5 mm barrel connector (alternative for limited space)



Pin #	Signal	Remark
1	NC	
2	RXD	Input to Display
3	TXD	Output from Display
4	NC	
5	GND	
6	NC	
7	NC	
8	NC	
9	NC	Provide +5V/2A power for external specific dongle *3.0
frame	GND	

Item	Signal	Remark
Tip	TXD	Output from Display
Ring	RXD	Input to Display
Sleeve	GND	

## LAN Hardware Specification

ViewSonic LFD communication port on the rear side:

1. Connector type: 8P8C RJ45
2. Pin Assignment:

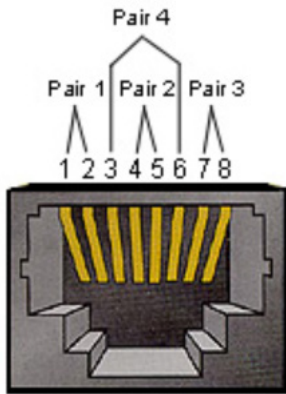

Pin #	Signal	Remark
1	TX+	Output from Display
2	TX-	Output from Display
3	RX+	Input to Display
4	BI_D3+	For 1G case
5	BI_D3-	For 1G case
6	RX-	Input to Display
7	BI_D4+	For 1G case
8	BI_D4-	For 1G case
frame	GND	

## RS232 Communication Setting

- Baud Rate Select: 9600bps (fixed)
- Data bits: 8 bits (fixed)
- Parity: None (fixed)
- Stop Bits: 1(fixed)

## LAN Communication Setting

- Type: Ethernet
- Protocol: TCP/IP
- Port: 5000 (fixed)
- Cross subnet: No
- Logon Credentials: No

## Command Message Reference

PC sends to LFD command packet followed by "CR". Every time PC sends control command to Display, the Display shall respond as follows:

1. If the message is received correctly it will send "+" (02Bh) followed by "CR" (00Dh)
2. If the message is received incorrectly it will send "-" (02Dh) followed by "CR" (00Dh)

# Protocol

## Set-Function Listing

The PC can control the Display for specific actions. The Set-Function command allows you to control the Display behavior at a remote site through the RS-232 port. The Set-Function packet format consists of 9 bytes.

### Set-Function Description:

- Length:** Total Byte of Message excluding "CR"
- LFD ID** Identification for each of Display (01~98; default is 01)  
ID "99" means to apply the set command for all connected displays. Under such circumstances, only ID#1 display has to reply.  
The LFD ID can be set via the OSD menu for each Display.
- Command Type** Identify command type,  
"s" (0x73h): Set Command  
"+" (0x2Bh): Valid command Reply  
"- " (0x2Dh): Invalid command Reply
- Command:** Function command code: One byte ASCII code.
- Value[1~3]:** Three bytes ASCII that defines the value.
- CR** 0x0D

### Set-Function Format

#### Send: (Command Type="s")

Name	Length	ID	Command Type	Command	Value1	Value2	Value3	CR
Byte Count	1 Byte	2 Byte	1 Byte	1 Byte	1 Byte	1 Byte	1 Byte	1 Byte
Bytes order	1	2~3	4	5	6	7	8	9

#### Reply: (Command Type="+" or "-")

Name	Length	ID	Command Type	CR
Byte Count	1 Byte	2 Byte	1 Byte	1 Byte
Bytes order	1	2~3	4	5

**NOTE:** When PC applies command to all displays (ID=99), only the #1 set needs to reply by the name of ID=1.



**Example 1: Set Brightness as 76 for Display (#02) and this command is valid**

**Send (Hex Format)**

Name	Length	ID	Command Type	Command	Value1	Value2	Value3	CR
Hex	0x38	0x30 0x32	0x73	0x24	0x30	0x37	0x36	0x0D

**Reply (Hex Format)**

Name	Length	ID	Command Type	CR
Hex	0x34	0x30 0x32	0x2B	0x0D

**Example 2: Set Brightness as 75 for Display (#02) and this command is NOT valid**

**Send (Hex Format)**

Name	Length	ID	Command Type	Command	Value1	Value2	Value3	CR
Hex	0x38	0x30 0x32	0x73	0x24	0x30	0x37	0x35	0x0D

**Reply (Hex Format)**

Name	Length	ID	Command Type	CR
Hex	0x34	0x30 0x32	0x2D	0x0D

## Set-Function Table

### A. Basic Function

Set Function	Length	ID	Command		Value Range	Comments	
			Type (ASCII)	Code (ASCII) Code (Hex)			
Power on/ off (standby)	8		s	!	21	000: STBY 001: ON	1. The Power-on via LAN control may work only under specific mode. To see display UG for details. *3.1.1 2. "WOL by MAC address" may available as alternative.*3.2.1
Input Select	8		s	"	22	000: TV 001: AV 002: S-Video 003: YPbPr 004: HDMI1 014: HDMI2 024: HDMI3 034: HDMI4  005: DVI 006: VGA1 016: VGA2 026: VGA3  007: Slot-in PC (OPS/SDM)/HDBT  008: Internal memory 009: DP  00A: Embedded/ Main (Android)	1. No need for USB 2. For the case of two more same sources, the 2nd digital is used to indicate the extension. 3. The HEX of 00A is 30 30 41.
Brightness	8		s	\$	24	000 ~ 100 900: Bright down (-1) 901: Bright up (+1) *3.1.1	
Backlight*3.2.0	8		A	B	42	000 ~ 100	1. For Android platform whose main mode is controlled by backlight and the other sources are controlled by brightness. 2. Derived from Color calibration. *3.2.0
Power lock	8		s	4	34	000: Unlock 001: Lock	*See note in details
Volume	8		s	5	35	000 ~ 100 900: Volume down(-1) 901:Volume up(+1)	
Mute	8		s	6	36	000: OFF 001: ON (mute)	

Set Function	Length	ID	Command	Command	Value Range	Comments
Button lock	8		s	8	38	000: Unlock 001: Lock *See note in details
Menu lock	8		s	>	3E	000: Unlock 001: Lock *See note in details
Number *3.1.1	8		s	@	40	000~009
Key Pad *3.1.1	8		s	A	41	000: UP 001: DOWN 002: LEFT 003: RIGHT 004: ENTER 005: INPUT 006: MENU/(EXIT) 007: EXIT
Remote Control	8		s	B	42	000: Disable 001: Enable 002: Pass through <b>Disable:</b> RCU will be no function <b>Enabled:</b> RCU controls normally <b>Pass through:</b> Display will bypass the RC code to connected device via the RS232 port, but not react itself.
Restore default	8		s	~	7E	000 Recover to factory setting

**NOTE:**

**1. Behavior at Lock Modes**

<b>Lock Mode</b>	<b>Behavior</b>
Button Lock	<ol style="list-style-type: none"><li>1. Lock all buttons on the front panel and RCU, except for "Power"</li><li>2. All the SET functions should be workable via RS-232, even the ones with according hot key in RCU like Mute,...etc.</li></ol>
MENU Lock	<ol style="list-style-type: none"><li>1. Lock "MENU" key of front panel and RCU</li><li>2. The Factory and Hospitality modes should not be blocked for the model using MENU-combined key to enter these two modes. Alternative approach will be indicated separately if any limitation by model.</li></ol>
POWER Lock	<ol style="list-style-type: none"><li>1. Lock "POWER" key on the front and RCU.</li><li>2. The SET_POWER on/off should be workable via RS-232, but does not mean the POWER lock will be released under this case.</li><li>3. Can not be unlocked by reset in OSD setting</li><li>4. Will auto AC power-on in power-lock</li><li>5. Under power-lock, the set will not enter power saving when no PC signal and neither not turn off when no other video signals after 15 minutes.</li></ol>
Remote control disable	Lock the RCU keys, but keep the front panel buttons workable.

**2. Wake-on-LAN by MAC address as alternative for SET Power on**  
(Length=126 Bytes)

<b>6 Bytes</b>	<b>6 Bytes (#1)</b>	<b>6 Bytes (#2)</b>	<b>...</b>	<b>6 Bytes (#16)</b>	<b>24 Bytes</b>
0xFF FF ... FF	MAC address	MAC address	...	MAC address	0x00 00 ... 00

## B. Optional Function

Set Function	Length	ID	Command		Value Range (Three ASCII bytes)	Comments
			Type (ASCII)	Code (ASCII) Code (Hex)		
Contrast	8		s	# 23	000 ~ 100	
Sharpness	8		s	% 25	000 ~ 100	
Color	8		s	& 26	000 ~ 100	
Tint	8		s	' 27	000 ~ 100	
Backlight On_Off	8		s	( 29	000: Off 001: On	
Color mode	8		s	) 29	000: Normal 001: Warm 002: Cold 003: Personal	
Surround sound	8		s	- 2D	000: OFF 001: ON	
Bass	8		s	. 2E	000 ~ 100	
Treble	8		s	/ 2F	000 ~ 100	
Balance	8		s	0 30	000 ~ 100	050 is central
Picture Size	8		s	1 31	000: FULL (16:9) 001: NORMAL (4:3) 002: REAL (1:1) *3.1.0	
OSD language	8		s	2 32	000: English 001: French 002: Spanish	Could be extended for more supported languages by model
PIP-Mode	8		s	9 39	000: OFF 001: PIP(POP) 002: PBP	
PIP-Sound select	8		s	: 3A	000: Main 001: Sub	
PIP-Position	8		s	; 3B	000: Up 001: Down 002: Left 003: Right	
PIP-Input	8		s	7 37 *2.9	000: TV 001: AV 002: S-Video 003: YPbPr 004: HDMI1 014: HDMI2 024: HDMI3 034: HDMI4  005: DVI 006: VGA1 016: VGA2 026: VGA3  007: Slot-in PC (OPS/SDM)/HDBT 008: Internal memory 009: DP  00A: Embedded/Main (Android)	Value range is same as SET-Input select

Set Function	Length	ID	Command	Command	Value Range	Comments
Tiling-Mode	8		s	P	50	000: OFF 001: ON  (for video wall)
Tiling-Compensation	8		s	Q	51	000: OFF 001: ON  (for video wall) Bezel width compensation
Tiling-H by V Monitors	8		s	R	52	01x~09x: H 0x1~0x9: V  (for video wall) 1. 2nd digital for H monitors 2. 3rd digital for V monitors
Tiling-Position	8		s	S	53	001~025  (for Video wall) Copy the screen of Position# to identified display
Date: Year	8		s	V	56	Y17~Y99  Last 2 digits (20)17~(20)99
Date: Month	8		s	V	56	M01~M12  2 digits
Date: Day	8		s	V	56	D01~D31  2 digits
Time: Hour	8		s	W	57	H00~H23  24-hr format. 2 digits.
Time: Min	8		s	W	57	M00~M59  2 digits
Time: Sec	8		s	W	57	S00~S59  2 digits

**NOTE:**

**1. Tiling definition of H Monitors, V Monitors, and Position**

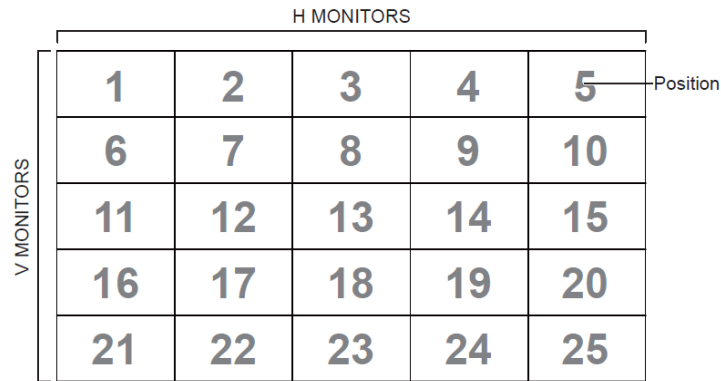

**2. Set Date example**

Date: 2017-3/15

Send: 0x 38 30 31 73 56 59 31 37 0D ("Y17")

Send: 0x 38 30 31 73 56 4D 30 33 0D ("M03")

Send: 0x 38 30 31 73 56 44 31 35 0D ("D15")

**3. Set Time example**

Time: 16:27:59

Send: 0x 38 30 31 73 57 48 31 36 0D ("H16")

Send: 0x 38 30 31 73 57 4D 32 37 0D ("M27")

Send: 0x 38 30 31 73 57 53 35 39 0D ("S59")

## Get-Function Listing

The PC can interrogate the LFD for specific information. The Get-Function packet format consists of 9 bytes which is similar to the Set-Function packet structure. Note that the “Value” byte is always = 000.

### Get-Function Description:

- Length:** Total Byte of Message excluding “CR”.
- TV/DS ID** Identification for each of TV/DS (01~98; default is 01).
- Command Type** Identify command type,  
 “g” (0x67h) : Get Command  
 “r” (0x72h) : Valid command Reply  
 “-” (0x2Dh) : Invalid command Reply
- Command:** Function command code: One byte ASCII code.
- Value[1~3]:** Three bytes ASCII that defines the value.
- CR** 0x0D

### Get-Function Format

#### Send: (Command Type=“g”)

Name	Length	ID	Command Type	Command	Value1	Value2	Value3	CR
Byte Count	1 Byte	2 Byte	1 Byte	1 Byte	1 Byte	1 Byte	1 Byte	1 Byte
Bytes order	1	2~3	4	5	6	7	8	9

#### Reply: (Command Type=“r” or “-”)

*If the Command is valid, Command Type = “r”*

Name	Length	ID	Command Type	Command	Value1	Value2	Value3	CR
Byte Count	1 Byte	2 Byte	1 Byte	1 Byte	1 Byte	1 Byte	1 Byte	1 Byte
Bytes order	1	2~3	4	5	6	7	8	9

**If the Command is NOT valid, Command Type = “-”**

Name	Length	ID	Command Type	CR
Byte Count	1 Byte	2 Byte	1 Byte	1 Byte
Bytes order	1	2~3	4	5



**Example 1: Get Brightness from TV-05 and this command is valid. The Brightness value is 67.**

**Send (Hex Format)**

Name	Length	ID	Command Type	Command	Value1	Value2	Value3	CR
Hex	0x38	0x30 0x35	0x67	0x62	0x30	0x30	0x30	0x0D

**Reply (Hex Format)**

Name	Length	ID	Command Type	Command	Value1	Value2	Value3	CR
Hex	0x38	0x30 0x35	0x72	0x62	0x30	0x36	0x37	0x0D

**Example 2: Get Color from Display (#05), but the Color command is not supported by this model.**

**Send (Hex Format)**

Name	Length	ID	Command Type	Command	Value1	Value2	Value3	CR
Hex	0x38	0x30 0x35	0x67	0x26	0x30	0x30	0x30	0x0D

**Reply (Hex Format)**

Name	Length	ID	Command Type	CR
Hex	0x34	0x30 0x35	0x2D	0x0D

# Get-Function Table

## A. Basic Function

Get Function	Length	ID	Command		Response Range (Three ASCII bytes)	Comments
			Type (ASCII)	Code (ASCII) Code (Hex)		
Get-Brightness	8		g	b 62	000 ~ 100	
Get-Backlight <sup>*3.2.0</sup>	8		a	B 42	000 ~ 100	1. For Android platform whose main mode is controlled by backlight and the other sources are controlled by brightness. 2. Derived from Color calibration. <sup>*3.2.0</sup>
Get-Volume	8		g	f 66	000 ~ 100	
Get-Mute	8		g	g 67	000: Off 001: On (muted)	
Get-Input select	8		g	j 6A	000~ 100~	1. 1st digit for signal detection: 0 means "no signal"; 1 means "signal detected" 2. 2nd & 3rd digit: See Set-function table
Get-Power status: ON/ STBY	8		g	l 6C	001: ON 000: STBY	
Get-Remote control	S		g	n 6E	000: Disable 001: Enable 002: Pass through	Get RCU mode status
Get-Power lock	8		g	o 6F	000: Unlock 001: Lock	
Get-Button lock	8		g	p 70	000: Unlock 001: Lock	
Get-Menu lock	8		g	l 6C	000: Unlock 001: Lock	
Get-ACK	8		g	z 7A	000	This command is used to test the communication link
Get-Thermal	8		g	0 30	000~100: 0~+100 deg C -01~-99: -1~-99 deg C	
Get-Operation time <sup>*3.2.0</sup>	8		g	1 31	000	1. Accumulated hours in 6-digit integer (000,001~999,999) <sup>*3.2.0</sup> 2. Can not be reset when FW update and Factory initiation <sup>*3.2.2</sup> 3. Reply in new 32-byte format <sup>*3.2.0</sup>
Get-Device name	8		g	4 34	000	Reply in new 32-byte format <sup>*3.2.0</sup>

Get Function	Length	ID	Command	Command		Response Range	Comments
Get-MAC address	8		g	5	35	000	(for the model with LAN) Reply in new 32-byte format*3.2.0
Get-IP address *3.2.0	8		g	6	36	000	(for the model with LAN) Reply in new 32-byte format*3.2.0
Get-Serial number *3.2.0	8		g	7	37	000	Reply in new 32-byte format *3.2.0
Get-FW version *3.2.0	8		g	8	38	000	Reply in new 32-byte format *3.2.0

**NOTE:**

**1. Get Operation Hour example**

Assumed the accumulated operation hour is 123,456 hrs

Send: 0x 38 30 31 67 31 30 30 30 0D (Get Operation hour)

Reply: 0x 32 30 31 72 31 31 32 33 34 35 36 00 00 ... 00 00 0D

**2. Get Device Name example**

Assumed the device name is CDE-5500

Send: 0x 38 30 31 67 34 30 30 30 0D (Get Device Name)

Reply: 0x 32 30 31 72 34 43 44 45 2D 35 35 30 30 00 00 ... 00 00 0D

Assumed the device name is "NMP-302#1"

Send: 0x 38 30 31 67 34 30 30 30 0D (Get Device Name)

Reply: 0x 32 30 31 72 34 4E 4D 50 2D 33 30 32 23 31 00 00 ...00 00 0D

**3. Get MAC address example**

Assumed the MAC address is 00:11:22:aa:bb:cc

Send: 0x 38 30 31 67 35 30 30 30 0D (Get MAC add)

Reply: 0x 32 30 31 72 35 30 30 31 31 32 32 61 61 62 62 63 63 00 00...00 00 0D

**4. Get IP address example**

Assumed the IP address is 192.168.100.2

Send: 0x 38 30 31 67 36 30 30 30 0D (Get IP address)

Reply: 0x 32 30 31 72 36 31 39 32 2E 31 36 38 2E 31 30 30 2E 32 00 00...00 00 0D

**5. Get Serial number example**

Assumed the Serial number is ABC180212345

Send: 0x 38 30 31 67 37 30 30 30 0D (Get Serial number)

Reply: 0x 32 30 31 72 37 41 42 43 31 38 30 32 31 32 33 34 35 00 00...00 00 0D

**6. Get FW version example**

Assumed the FW version is 3.02.001

Send: 0x 38 30 31 67 38 30 30 30 0D (Get FW version)

Reply: 0x 32 30 31 72 38 33 2E 30 32 2E 30 30 31 00 00...00 00 0D

## B. Optional Function

Get Function	Length	ID	Command		Response Range (Three ASCII bytes)	Comments
			Type (ASCII)	Code (ASCII) Code (Hex)		
Get-Contrast	8		g	a 61	000 ~ 100	
Get-Sharpness	8		g	c 63	000 ~ 100	
Get-Color	8		g	d 64	000 ~ 100	
Get-Tint	8		g	e 65	000 ~ 100	
Get-Backlight On_Off	8		g	h 68	000: Off 001: On	
Get-PIP mode	8		g	t 74	000: OFF 001: PIP (POP) 002: PBP	
Get-PIP input	8		g	u 75	000 ~	See Set-input select
Get-Tiling Mode	8		g	v 76	000: OFF 001: ON	(for Video wall)
Get-Tiling Compensation	8		g	w 77	000: OFF 001: ON	(for Video wall) Bezel width compensation
Get-Tiling H by V monitors	8		g	x 78	01x~09x: H monitors 0x1~0x9: V monitors	(for Video wall) 1. 2nd digital for H monitors 2. 3rd digital for V monitors
Get-Tiling position	8		g	y 79	000: OFF 001~025	(for Video wall) Copy the screen of Position# to identified display
Get-Date: Year	8		g	2 32	Y00~Y00	Last 2 digits (20)17~(20)99
Get-Date: Month	8		g	2 32	M00~M00	2 digits
Get-Date: Day	8		g	2 32	D00~M00	2 digits
Get-Time: Hour	8		g	3 33	H00~H00	24-hr format. 2 digits
Get-Time: Min	8		g	3 33	M00~M00	2 digits
Get-Time: Sec	8		g	3 33	S00~S00	2 digits

**NOTE:**

**1. Get Date example**

Assumed the current date of display#01 as below:

Date: 2017-3/15

Send: 0x 38 30 31 67 32 59 30 30 0D (Get Date:Year)

Reply: 0x 38 30 31 72 32 59 31 37 0D ("Y17")

Send: 0x 38 30 31 67 32 4D 30 30 0D (Get Date:Month)

Reply: 0x 38 30 31 72 32 4D 30 33 0D ("M03")

Send: 0x 38 30 31 67 32 44 30 30 0D (Get Date:Day)

Reply: 0x 38 30 31 72 32 44 31 35 0D ("D15")

**2. Get Time example**

Assumed the current time of display#01 as below:

Time: 16:27:59

Send: 0x 38 30 31 67 33 48 30 30 0D (Get Time:Hour)

Reply: 0x 38 30 31 72 33 48 31 36 0D ("H16")

Send: 0x 38 30 31 67 33 4D 30 30 0D (Get Time:Min)

Reply: 0x 38 30 31 72 33 4D 32 37 0D ("M27")

Send: 0x 38 30 31 67 33 53 30 30 0D (Get Time:Sec)

Reply: 0x 38 30 31 72 33 53 35 39 0D ("S59")

**3. Get RS232 Version example**

Assumed the version is 3.0.1

Send: 0x 38 30 31 67 36 30 30 30 0D (Get RS232 version)

Reply: 0x 38 30 31 72 36 33 30 31 0D ("301")

### **C. Auto Reply \*3.2.1**

The display will send out the updated data/status automatically without getting a query from the host whenever the following data/status is changed by the user through any of the available ways like: remote control unit, front keys, or touch screen.

- Power On/Off
- Input Select
- Brightness
- Backlight
- Volume
- Mute On/Off

## Remote Control Pass-through Mode

When the PC sets the Display to Remote Control Pass through mode, the Display will send a 7-byte packet (followed by “CR”) in response to remote control unit (RCU) button activation. In this mode the remote control shall have no effect on the Display function. For example: “Volume+” will not change the volume of the Display, but instead only sends the “Volume+” code to the PC over the RS-232 port.

### IR Pass Through-Function format

Reply: (Command Type=“p”)

Name	Length	ID	Command Type	RCU Code1 (MSB)	RCU Code2 (LSB)	CR
Byte Count	1 Byte	2 Byte	1 Byte	1 Byte	1 Byte	1 Byte
Bytes order	1	2~3	4	5	6	7

### Example 1: Remote Control Pass-through when “VOL+” key is pressed for Display (#5)

Send (Hex Format)

Name	Length	ID	Command Type	RCU Code1 (MSB)	RCU Code2 (LSB)	CR
Hex	0x36	0x30 0x35	0x70	0x31	0x30	0x0D

Key	Code (HEX)	Basic *3.1.1	Optional *3.1.1
1	01	V	
2	02	V	
3	03	V	
4	04	V	
5	05	V	
6	06	V	
7	07	V	
8	08	V	
9	09	V	
0	0A	V	
-	0B		V
RECALL (LAST)	0C		V
INFO (DISPLAY)	0D		V
	0E		
ASPECT (ZOOM, SIZE)	0F		V
VOLUME UP (+)	10	V	



Key	Code (HEX)	Basic *3.1.1	Optional *3.1.1
VOLUME DOWN (-)	11	V	
MUTE	12	V	
CHANNEL/PAGE UP (+)/ BRIGHTNESS+	13		V
CHANNEL/PAGE DOWN (-)/ BRIGHTNESS-	14		V
POWER	15	V	
SOURCES (INPUTS)	16	V	
	17		
	18		
SLEEP	19		V
MENU	1A	V	
UP	1B	V	
DOWN	1C	V	
LEFT (-)	1D	V	
RIGHT (+)	1E	V	
OK (ENTER, SET)	1F	V	
EXIT	20	V	
	21		
	22		
	23		
	24		
	25		
	26		
	27		
	28		
	29		
	2A		
	2B		
RED ■ (F1)	2C		
GREEN ■ (F2)	2D		
YELLOW ■ (F3)	2E		
BLUE ■ (F4)	2F		

**NOTE:**

- 1.** This IR-pass-through code is different from the RCU key code.
- 2.** Special control sequence for POWER key under IR-pass through mode.
  - 2-1.** When Display is OFF and receives the IR POWER code: Display will turn itself on, then forward the POWER code to the host via RS-232.
  - 2-2.** When Display is ON and receives the IR POWER code: Display will forward the POWER code to the host via RS-232, then turn off itself.
  - 2-3.** When SET-POWER LOCK is enabled, the Display will not respond to POWER key pressing.
- 3.** The VOLUME UP and VOLUME DOWN code will repeatedly output when you press and hold the keys.

# Appendix

## Specifications

Item	Category	Specifications		
Model		IFP6533	IFP7533	IFP8633
Screen	Size	64.5"	74.5"	85.6"
	Display Area (mm)	1428.48(H) x 803.52(V)	1649.66(H) x 927.94(V)	1913.04(H) x 1083.96(V)
	Surface Treatment	Anti-Glare (Haze 25%), Hard Coating (3H)		
	Brightness	350 nits (Typical)		
	Native Resolution	3840 x 2160 (UHD)		
Input Signal		3 x HDMI (v. 2.0, HDCP 2.2) 1 x VGA 1 x Audio In (3.5 mm) 1 x RS-232 1 x USB Type C (DP v. 1.2; PD 65W; 10M/100M Ethernet) 1 x USB Type A (2.0) 4 x USB Type A (3.0)		
Output Signal		1 x HDMI 1 x Audio Out 1 x SPDIF 2 x USB Type B (for touch)		
Network	LAN	10M/100M/1000M (for Embedded Player) 10M/100M/1000M (for Slot-in PC)		
	Wi-Fi	1 x Wi-Fi Slot		
PC Slot		1 x 80-pin OPS		
Speaker Output		2 x 16W (Speaker)		
RS-232		RS-232 Communication		
Power	Voltage	100V-240V AC 50/60Hz		
Operating Conditions	Temperature	32° F to 104° F (0° C to 40° C)		
	Humidity	20%~80% non-condensing		
	Altitude	≤ 3,000 m		

Item	Category	Specifications		
Storage Conditions	Temperature	-4° F to 140° F (-20° C to 60° C)		
	Humidity	10%~90% non-condensing		
	Altitude	≤ 3,000 m		
Dimensions	Physical (mm)	1488.3 x 896.6 x 85.3	1709.4 x 1020.2 x 85.5	1957 x 1059.9 x 97.4
	Physical (in)	58.59" x 35.29" x 3.36"	67.29" x 40.16" x 3.36"	77.04" x 41.72" x 3.83"
Weight	Physical (kg)	34.95 kg	47.3 kg	58.55 kg
	Physical (lbs)	77.1 lbs.	104.3 lbs.	129.1 lbs.
Power Consumption	On (Typical)	132W	156W	182W
	Off	< 0.5W	< 0.5W	< 0.5W

**NOTE:** Product specifications are subject to change without notice.

# Display Modes

## VGA Mode

Resolution	Refresh Rate (@)
640 x 480	60Hz, 72Hz, 75Hz
720 x 400	70Hz
800 x 600	56Hz, 60Hz, 72Hz, 75Hz
832 x 624	75Hz
1024 x 768	60Hz, 70Hz, 75Hz
1152 x 864	60Hz, 75Hz
1152 x 870	75Hz
1280 x 768	60Hz, 75Hz
1280 x 960	60Hz
1280 x 1024	60Hz, 75Hz
1360 x 768	60Hz
1366 x 768	60Hz
1440 x 900	60Hz, 75Hz
1400 x 1050	60Hz, 75Hz
1600 x 1200	60Hz
1680 x 1050	60Hz
1920 x 1080	60Hz
1920 x 1200	60Hz

## HDMI Mode

Resolution	Refresh Rate (@)
640 x 480	60Hz, 72Hz
720 x 400	70Hz
800 x 600	60Hz, 72Hz
1024x768	60Hz, 70Hz, 75Hz
1280x800	60Hz
1280x1024	60Hz
1360x768	60Hz
1440x900	60Hz
1680x1050	60Hz
1920x1080	60Hz
3840x2160	30Hz, 60Hz
480i	60Hz
480p	59Hz, 60Hz
576i	50Hz
720p	50Hz, 60Hz
576p	50Hz
1080i	50Hz, 60Hz
1080p	50Hz, 60Hz

## Troubleshooting

This section describes some common problems that you may experience when using the ViewBoard.

Problem or Issue	Possible Solutions
Remote Control is not working	<ol style="list-style-type: none"><li>1. Check whether something is obstructing the display's remote control receiver.</li><li>2. Check whether the batteries in the remote control are installed correctly.</li><li>3. Check whether the batteries need to be replaced.</li></ol>
The unit turns off unexpectedly	<ol style="list-style-type: none"><li>1. Check whether Sleep mode is enabled.</li><li>2. Check if there is a power outage in your area.</li><li>3. Turn on the display and see if the problem is with the signal and control system.</li></ol>

### PC Mode

Problem or Issue	Possible Solutions
No PC signal	<ol style="list-style-type: none"><li>1. Check the display settings.</li><li>2. Check the display resolution.</li><li>3. Adjust the Hs &amp; Vs (synchronization) settings using the OSD menu.</li></ol>
Background streaking	<ol style="list-style-type: none"><li>1. Choose auto adjust.</li><li>2. Adjust clock and phase.</li></ol>
Unsupported format	<ol style="list-style-type: none"><li>1. Choose auto adjust.</li><li>2. Adjust clock and phase settings.</li></ol>

## Touch Function

Problem or Issue	Possible Solutions
Touch function does not work	<ol style="list-style-type: none"><li>1. Check that drivers are installed correctly.</li><li>2. Reinstall driver(s).</li><li>3. Check setup and align it.</li><li>4. Check whether the touch pen is working properly.</li></ol>

## Video Not Working Properly

Problem or Issue	Possible Solutions
No picture/ No sound	<ol style="list-style-type: none"><li>1. Check the Power status.</li><li>2. Check the signal cable.</li><li>3. Check that the internal PC is installed correctly.</li></ol>
Picture is unclear or cuts in and out	<ol style="list-style-type: none"><li>1. Check the signal cable.</li><li>2. Check if other electronics are interrupting the signal.</li></ol>
Poor picture	<ol style="list-style-type: none"><li>1. Adjust chroma, brightness, and contrast settings in the menu.</li><li>2. Check the signal cable.</li></ol>

## Audio Not Working Properly

Problem or Issue	Possible Solutions
No sound	<ol style="list-style-type: none"><li>1. Press the Mute/Unmute button.</li><li>2. Adjust the volume.</li><li>3. Check the audio cable.</li></ol>
One speaker only	<ol style="list-style-type: none"><li>1. Adjust the sound balance in the menu.</li><li>2. Check the sound control panel settings of the computer.</li><li>3. Check the audio cable.</li></ol>

# Maintenance

## General Precautions

- Make sure the device is turned off and the power cable is unplugged from the power outlet.
- Never spray or pour any liquid directly onto the screen or case.
- Handle the device with care, as a darker-colored device, if scuffed, may show marks more clearly than a lighter-colored device.
- Do not use the system continuously for long periods of time.

## Cleaning the Screen

- Wipe the screen with a clean, soft, lint-free cloth. This removes dust and other particles.
- If the screen is still not clean, apply a small amount of non-ammonia, non-alcohol based glass cleaner onto a clean, soft, lint-free cloth; then wipe the screen.

## Cleaning the Case

- Use a soft, dry cloth.
- If the case is still not clean, apply a small amount of non-ammonia, non-alcohol based, mild non-abrasive detergent onto a clean, soft, lint-free cloth, then wipe the surface.

## Disclaimer

- ViewSonic® does not recommend the use of any ammonia or alcohol-based cleaners on the display screen or case. Some chemical cleaners have been reported to damage the screen and/or case of the device.
- ViewSonic® will not be liable for damage resulting from use of any ammonia or alcohol-based cleaners.

**NOTE:** If condensation appears between the glass and the panel, keep the display turned on until the moisture disappears.



# Regulatory and Service Information

## Compliance Information

This section addresses all connected requirements and statements regarding regulations. Confirmed corresponding applications shall refer to nameplate labels and relevant markings on the unit.

### FCC Compliance Statement

This device complies with part 15 of FCC Rules. Operation is subject to the following two conditions: (1) this device may not cause harmful interference, and (2) this device must accept any interference received, including interference that may cause undesired operation. This equipment has been tested and found to comply with the limits for a Class B digital device, pursuant to part 15 of the FCC Rules.

These limits are designed to provide reasonable protection against harmful interference in a residential installation. This equipment generates, uses, and can radiate radio frequency energy, and if not installed and used in accordance with the instructions, may cause harmful interference to radio communications. However, there is no guarantee that interference will not occur in a particular installation. If this equipment does cause harmful interference to radio or television reception, which can be determined by turning the equipment off and on, the user is encouraged to try to correct the interference by one or more of the following measures:

- Reorient or relocate the receiving antenna.
- Increase the separation between the equipment and receiver.
- Connect the equipment into an outlet on a circuit different from that to which the receiver is connected.
- Consult the dealer or an experienced radio/TV technician for help.

**Warning:** You are cautioned that changes or modifications not expressly approved by the party responsible for compliance could void your authority to operate the equipment.

### Industry Canada Statement

CAN ICES-003(B) / NMB-003(B)

### CE Conformity for European Countries



The device complies with the EMC Directive 2014/30/EU and Low Voltage Directive 2014/35/EU.

**The following information is only for EU-member states:**

The mark shown to the right is in compliance with the Waste Electrical and Electronic Equipment Directive 2012/19/EU (WEEE). The mark indicates the requirement NOT to dispose of the equipment as unsorted municipal waste, but use the return and collection systems according to local law.



**Declaration of RoHS2 Compliance**

This product has been designed and manufactured in compliance with Directive 2011/65/EU of the European Parliament and the Council on restriction of the use of certain hazardous substances in electrical and electronic equipment (RoHS2 Directive) and is deemed to comply with the maximum concentration values issued by the European Technical Adaptation Committee (TAC) as shown below:

Substance	Proposed Maximum Concentration	Actual Concentration
Lead (Pb)	0.1%	< 0.1%
Mercury (Hg)	0.1%	< 0.1%
Cadmium (Cd)	0.01%	< 0.01%
Hexavalent Chromium (Cr6 <sup>+</sup> )	0.1%	< 0.1%
Polybrominated biphenyls (PBB)	0.1%	< 0.1%
Polybrominated diphenyl ethers (PBDE)	0.1%	< 0.1%
Bis (2-ethylhexyl) phthalate (DEHP)	0.1%	< 0.1%
Butyl benzyl phthalate (BBP)	0.1%	< 0.1%
Dibutyl phthalate (DBP)	0.1%	< 0.1%
Diisobutyl phthalate (DIBP)	0.1%	< 0.1%

**Certain components of products as stated above are exempted under the Annex III of the RoHS2 Directives as noted below:**

- Copper alloy containing up to 4% lead by weight.
- Lead in high melting temperature type solders (i.e. lead-based alloys containing 85% by weight or more lead).
- Electrical and electronic components containing lead in a glass or ceramic other than dielectric ceramic in capacitors, e.g. piezoelectronic devices, or in a glass or ceramic matrix compound.
- Lead in dielectric ceramic in capacitors for a rated voltage of 125V AC or 250V DC or higher.

## ENERGY STAR Statement

ENERGY STAR is a U.S. Environmental Protection Agency voluntary program that helps businesses and individuals save money and protect our climate through superior energy efficiency. Products that earn the ENERGY STAR prevent greenhouse gas emissions by meeting strict energy efficiency criteria or requirements set by the U.S. Environmental Protection Agency.

As an ENERGY STAR Partner, ViewSonic is determined to meet the Energy star Guidelines and mark all certified models with the ENERGY STAR logo.

The following logo appears on all ENERGY STAR-certified models:



**NOTE:** The power management features significantly reduce energy consumption when the product is not in use. Power management allows the device to automatically enter a low power “sleep” mode after a defined period of inactivity. And the power management features also enter Sleep Mode or Off Mode within 5 minutes of being disconnected from a host computer. Please note any change in energy settings will increase energy consumption.

## Indian Restriction of Hazardous Substances

Restriction on Hazardous Substances statement (India). This product complies with the “India E-waste Rule 2011” and prohibits use of lead, mercury, hexavalent chromium, polybrominated biphenyls or polybrominated diphenyl ethers in concentrations exceeding 0.1 weight % and 0.01 weight % for cadmium, except for the exemptions set in Schedule 2 of the Rule.

## Product Disposal at End of Product Life

ViewSonic® respects the environment and is committed to working and living green. Thank you for being part of Smarter, Greener Computing. Please visit the ViewSonic® website to learn more.

### USA & Canada:

<https://www.viewsonic.com/us/go-green-with-viewsonic>

### Europe:

<https://www.viewsonic.com/eu/environmental-social-governance/recycle>

### Taiwan:

<https://recycle.moenv.gov.tw/>

**For EU users, please contact us for any safety/accident issue experienced with this product:**

ViewSonic Europe Limited



Haaksbergweg 75  
1101 BR Amsterdam  
Netherlands



+31 (0) 650608655



[EPREL@viewsoniceurope.com](mailto:EPREL@viewsoniceurope.com)



<https://www.viewsonic.com/eu/>

## Copyright Information

Copyright© ViewSonic® Corporation, 2023. All rights reserved.

Macintosh and Power Macintosh are registered trademarks of Apple Inc.

Microsoft, Windows, and the Windows logo are registered trademarks of Microsoft Corporation in the United States and other countries.

ViewSonic® and the three birds logo are registered trademarks of ViewSonic® Corporation.

VESA is a registered trademark of the Video Electronics Standards Association. DPMS, DisplayPort, and DDC are trademarks of VESA.

ENERGY STAR® is a registered trademark of the U.S. Environmental Protection Agency (EPA).

As an ENERGY STAR® partner, ViewSonic® Corporation has determined that this product meets the ENERGY STAR® guidelines for energy efficiency.

**Disclaimer:** ViewSonic® Corporation shall not be liable for technical or editorial errors or omissions contained herein; nor for incidental or consequential damages resulting from furnishing this material, or the performance or use of this product.

In the interest of continuing product improvement, ViewSonic® Corporation reserves the right to change product specifications without notice. Information in this document may change without notice.

No part of this document may be copied, reproduced, or transmitted by any means, for any purpose without prior written permission from ViewSonic® Corporation.

## Customer Service

For technical support or product service, see the table below or contact your reseller.

**NOTE:** You will need the product's serial number.

Country/ Region	Website	Country/ Region	Website
<b>Asia Pacific &amp; Africa</b>			
Australia	<a href="http://www.viewsonic.com/au/">www.viewsonic.com/au/</a>	Bangladesh	<a href="http://www.viewsonic.com/bd/">www.viewsonic.com/bd/</a>
中国 (China)	<a href="http://www.viewsonic.com.cn">www.viewsonic.com.cn</a>	香港 (繁體中文)	<a href="http://www.viewsonic.com/hk/">www.viewsonic.com/hk/</a>
Hong Kong (English)	<a href="http://www.viewsonic.com/hk-en/">www.viewsonic.com/hk-en/</a>	India	<a href="http://www.viewsonic.com/in/">www.viewsonic.com/in/</a>
Indonesia	<a href="http://www.viewsonic.com/id/">www.viewsonic.com/id/</a>	Israel	<a href="http://www.viewsonic.com/il/">www.viewsonic.com/il/</a>
日本 (Japan)	<a href="http://www.viewsonic.com/jp/">www.viewsonic.com/jp/</a>	Korea	<a href="http://www.viewsonic.com/kr/">www.viewsonic.com/kr/</a>
Malaysia	<a href="http://www.viewsonic.com/my/">www.viewsonic.com/my/</a>	Middle East	<a href="http://www.viewsonic.com/me/">www.viewsonic.com/me/</a>
Myanmar	<a href="http://www.viewsonic.com/mm/">www.viewsonic.com/mm/</a>	Nepal	<a href="http://www.viewsonic.com/np/">www.viewsonic.com/np/</a>
New Zealand	<a href="http://www.viewsonic.com/nz/">www.viewsonic.com/nz/</a>	Pakistan	<a href="http://www.viewsonic.com/pk/">www.viewsonic.com/pk/</a>
Philippines	<a href="http://www.viewsonic.com/ph/">www.viewsonic.com/ph/</a>	Singapore	<a href="http://www.viewsonic.com/sg/">www.viewsonic.com/sg/</a>
臺灣 (Taiwan)	<a href="http://www.viewsonic.com/tw/">www.viewsonic.com/tw/</a>	ประเทศไทย	<a href="http://www.viewsonic.com/th/">www.viewsonic.com/th/</a>
Việt Nam	<a href="http://www.viewsonic.com/vn/">www.viewsonic.com/vn/</a>	South Africa & Mauritius	<a href="http://www.viewsonic.com/za/">www.viewsonic.com/za/</a>
<b>Americas</b>			
United States	<a href="http://www.viewsonic.com/us">www.viewsonic.com/us</a>	Canada	<a href="http://www.viewsonic.com/us">www.viewsonic.com/us</a>
Latin America	<a href="http://www.viewsonic.com/la">www.viewsonic.com/la</a>		
<b>Europe</b>			
Europe	<a href="http://www.viewsonic.com/eu/">www.viewsonic.com/eu/</a>	France	<a href="http://www.viewsonic.com/fr/">www.viewsonic.com/fr/</a>
Deutschland	<a href="http://www.viewsonic.com/de/">www.viewsonic.com/de/</a>	Қазақстан	<a href="http://www.viewsonic.com/kz/">www.viewsonic.com/kz/</a>
Россия	<a href="http://www.viewsonic.com/ru/">www.viewsonic.com/ru/</a>	España	<a href="http://www.viewsonic.com/es/">www.viewsonic.com/es/</a>
Türkiye	<a href="http://www.viewsonic.com/tr/">www.viewsonic.com/tr/</a>	Україна	<a href="http://www.viewsonic.com/ua/">www.viewsonic.com/ua/</a>
United Kingdom	<a href="http://www.viewsonic.com/uk/">www.viewsonic.com/uk/</a>		

## Limited Warranty

### ViewSonic® Smart White Board

#### What the warranty covers:

ViewSonic® warrants its products to be free from defects in material and workmanship during the warranty period. If a product proves to be defective in material or workmanship during the warranty period, ViewSonic® will, at its sole option, and as your sole remedy, repair or replace the product with a similar product. Replacement Product or parts may include remanufactured or refurbished parts or components. The repair or replacement unit or parts or components will be covered by the balance of the time remaining on the customer's original limited warranty and the warranty period will not be extended. ViewSonic® provides no warranty for any third-party software whether included with the product or installed by the customer, installation of any unauthorized hardware parts or components (e.g. Projector Lamps). (Please refer to: "What the warranty excludes and does not cover" section).

#### Who the warranty protects:

This warranty is valid only for the first consumer purchaser.

#### What the warranty excludes and does not cover:

- Any product on which the serial number has been defaced, modified, or removed.
- Damage, deterioration, or malfunction resulting from:
  - » Accident, misuse, neglect, fire, water, lightning, or other acts of nature, unauthorized product modification, or failure to follow instructions supplied with the product.
  - » Repair or attempted repair by anyone not authorized by ViewSonic®.
  - » Damage to or loss of any programs, data, or removable storage media.
  - » Normal wear and tear.
  - » Removal or installation of the product.
- Software or data loss occurring during repair or replacement.
- Any damage of the product due to shipment.
- Causes external to the product, such as electric power fluctuations or failure.
- Use of supplies or parts not meeting ViewSonic's specifications.
- Failure of owner to perform periodic product maintenance as stated in the User Guide.

- Any other cause which does not relate to a product defect.
- Damage caused by static (non-moving) images displayed for lengthy periods of time (also referred to as image burn-in).
- Software - Any third-party software included with the product or installed by the customer.
- Hardware/Accessories/Parts/Components – Installation of any unauthorized hardware, accessories, consumable parts or components (e.g. Projector Lamps).
- Damage to, or abuse of, the coating on the surface of the display through inappropriate cleaning as described in the product User Guide.
- Removal, installation, and set-up service charges, including wall-mounting of the product.

### **How to get service:**

- For information about receiving service under warranty, contact ViewSonic® Customer Support (Please refer to the “Customer Service” page). You will need to provide your product’s serial number.
- To obtain warranty service, you will be required to provide: (a) the original dated sales slip, (b) your name, (c) your address, (d) a description of the problem, and (e) the serial number of the product.
- Take or ship the product, freight prepaid, in the original container to an authorized ViewSonic® service center or ViewSonic®.
- For additional information or the name of the nearest ViewSonic® service center, contact ViewSonic®.

### **Limitation of implied warranties:**

There are no warranties, express or implied, which extend beyond the description contained herein including the implied warranty of merchantability and fitness for a particular purpose.



**Exclusion of damages:**

ViewSonic's liability is limited to the cost of repair or replacement of the product. ViewSonic® shall not be liable for:

- Damage to other property caused by any defects in the product, damages based upon inconvenience, loss of use of the product, loss of time, loss of profits, loss of business opportunity, loss of goodwill, interference with business relationships, or other commercial loss, even if advised of the possibility of such damages.
- Any other damages, whether incidental, consequential or otherwise.
- Any claim against the customer by any other party.
- Repair or attempted repair by anyone not authorized by ViewSonic®.

**Effect of state law:**

This warranty gives you specific legal rights, and you may also have other rights which vary from state to state. Some states do not allow limitations on implied warranties and/or do not allow the exclusion of incidental or consequential damages, so the above limitations and exclusions may not apply to you.

**Sales outside the U.S.A. and Canada:**

For warranty information and service on ViewSonic® products sold outside of the U.S.A. and Canada, contact ViewSonic® or your local ViewSonic® dealer.

The warranty period for this product in mainland China (Hong Kong, Macao, and Taiwan Excluded) is subject to the terms and conditions of the Maintenance Guarantee Card.

For users in Europe and Russia, full details of warranty provided can be found at: <http://www.viewsonic.com/eu/> under "Support/Warranty Information".

## **Mexico Limited Warranty**

### ViewSonic® Smart White Board

#### **What the warranty covers:**

ViewSonic® warrants its products to be free from defects in material and workmanship, under normal use, during the warranty period. If a product proves to be defective in material or workmanship during the warranty period, ViewSonic® will, at its sole option, repair or replace the product with a like product. Replacement product or parts may include remanufactured or refurbished parts or components & accessories.

#### **Who the warranty protects:**

This warranty is valid only for the first consumer purchaser.

#### **What the warranty excludes and does not cover:**

- Any product on which the serial number has been defaced, modified or removed.
- Damage, deterioration, or malfunction resulting from:
  - » Accident, misuse, neglect, fire, water, lightning, or other acts of nature, unauthorized product modification, unauthorized attempted repair, or failure to follow instructions supplied with the product.
  - » Causes external to the product, such as electrical power fluctuations or failure.
  - » Use of supplies or parts not meeting ViewSonic®'s specifications.
  - » Normal wear and tear.
  - » Any other cause which does not relate to a product defect.
- Any product exhibiting a condition commonly known as “image burn-in” which results when a static image is displayed on the product for an extended period of time.
- Removal, installation, insurance, and set-up service charges.

**How to get service:**

For information about receiving service under warranty, contact ViewSonic® Customer Support (Please refer to the attached “Customer Service” page). You will need to provide your product’s serial number, so please record the product information in the space provided below on your purchase for your future use. Please retain your receipt of proof of purchase to support your warranty claim.

**For Your Records**

Product Name: \_\_\_\_\_ Model Number: \_\_\_\_\_  
Document Number: \_\_\_\_\_ Serial Number: \_\_\_\_\_  
Purchase Date: \_\_\_\_\_ Extended Warranty Purchase? \_\_\_\_\_(Y/N)  
If so, what date does warranty expire? \_\_\_\_\_

- To obtain warranty service, you will be required to provide (a) the original dated sales slip, (b) your name, (c) your address, (d) a description of the problem, and (e) the serial number of the product.
- Take or ship the product, in the original container packaging, to an authorized ViewSonic® service center.
- Round trip transportation costs for in-warranty products will be paid by ViewSonic®.

**Limitation of implied warranties:**

There are no warranties, express or implied, which extend beyond the description contained herein including the implied warranty of merchantability and fitness for a particular purpose.

**Exclusion of damages:**

ViewSonic®’s liability is limited to the cost of repair or replacement of the product. ViewSonic® shall not be liable for:

- Damage to other property caused by any defects in the product, damages based upon inconvenience, loss of use of the product, loss of time, loss of profits, loss of business opportunity, loss of goodwill, interference with business relationships, or other commercial loss, even if advised of the possibility of such damages.
- Any other damages, whether incidental, consequential or otherwise.
- Any claim against the customer by any other party.
- Repair or attempted repair by anyone not authorized by ViewSonic®.

Contact Information for Sales & Authorized Service (Centro Autorizado de Servicio) within Mexico:	
<b>Name, address, of manufacturer and importers:</b> México, Av. de la Palma #8 Piso 2 Despacho 203, Corporativo Interpalmas, Col. San Fernando Huixquilucan, Estado de México Tel: (55) 3605-1099 <a href="http://www.viewsonic.com/la/soporte/index.htm">http://www.viewsonic.com/la/soporte/index.htm</a>	
NÚMERO GRATIS DE ASISTENCIA TÉCNICA PARA TODO MÉXICO: 001.866.823.2004	
<b>Hermosillo:</b> Distribuciones y Servicios Computacionales SA de CV. Calle Juarez 284 local 2 Col. Bugambilias C.P: 83140 Tel: 01-66-22-14-9005 E-Mail: <a href="mailto:disc2@hmo.megared.net.mx">disc2@hmo.megared.net.mx</a>	<b>Villahermosa:</b> Compumantenimientos Garantizados, S.A. de C.V. AV. GREGORIO MENDEZ #1504 COL, FLORIDA C.P. 86040 Tel: 01 (993) 3 52 00 47 / 3522074 / 3 52 20 09 E-Mail: <a href="mailto:compumantenimientos@prodigy.net.mx">compumantenimientos@prodigy.net.mx</a>
<b>Puebla, Pue. (Matriz):</b> RENTA Y DATOS, S.A. DE C.V. Domicilio: 29 SUR 721 COL. LA PAZ 72160 PUEBLA, PUE. Tel: 01(52).222.891.55.77 CON 10 LINEAS E-Mail: <a href="mailto:datos@puebla.megared.net.mx">datos@puebla.megared.net.mx</a>	<b>Veracruz, Ver.:</b> CONEXION Y DESARROLLO, S.A DE C.V. Av. Americas # 419 ENTRE PINZÓN Y ALVARADO Fracc. Reforma C.P. 91919 Tel: 01-22-91-00-31-67 E-Mail: <a href="mailto:gacosta@qplus.com.mx">gacosta@qplus.com.mx</a>
<b>Chihuahua:</b> Soluciones Globales en Computación C. Magisterio # 3321 Col. Magisterial Chihuahua, Chih. Tel: 4136954 E-Mail: <a href="mailto:Cefeo@soluglobales.com">Cefeo@soluglobales.com</a>	<b>Cuernavaca:</b> Compusupport de Cuernavaca SA de CV Francisco Leyva # 178 Col. Miguel Hidalgo C.P. 62040, Cuernavaca Morelos Tel: 01 777 3180579 / 01 777 3124014 E-Mail: <a href="mailto:aquevedo@compusupportcva.com">aquevedo@compusupportcva.com</a>
<b>Distrito Federal:</b> QPLUS, S.A. de C.V. Av. Coyoacán 931 Col. Del Valle 03100, México, D.F. Tel: 01(52)55-50-00-27-35 E-Mail : <a href="mailto:gacosta@qplus.com.mx">gacosta@qplus.com.mx</a>	<b>Guadalajara, Jal.:</b> SERVICRECE, S.A. de C.V. Av. Niños Héroes # 2281 Col. Arcos Sur, Sector Juárez 44170, Guadalajara, Jalisco Tel: 01(52)33-36-15-15-43 E-Mail: <a href="mailto:mmiranda@servicrece.com">mmiranda@servicrece.com</a>
<b>Guerrero Acapulco:</b> GS Computación (Grupo Sesicomp) Progreso #6-A, Colo Centro 39300 Acapulco, Guerrero Tel: 744-48-32627	<b>Monterrey:</b> Global Product Services Mar Caribe # 1987, Esquina con Golfo Pérsico Fracc. Bernardo Reyes, CP 64280 Monterrey N.L. México Tel: 8129-5103 E-Mail: <a href="mailto:aydeem@gps1.com.mx">aydeem@gps1.com.mx</a>
<b>MERIDA:</b> ELECTROSER Av Reforma No. 403Gx39 y 41 Mérida, Yucatán, México CP97000 Tel: (52) 999-925-1916 E-Mail: <a href="mailto:rrrb@sureste.com">rrrb@sureste.com</a>	<b>Oaxaca, Oax.:</b> CENTRO DE DISTRIBUCION Y SERVICIO, S.A. de C.V. Murguía # 708 P.A., Col. Centro, 68000, Oaxaca Tel: 01(52)95-15-15-22-22 Fax: 01(52)95-15-13-67-00 E-Mail: <a href="mailto:gpotai2001@hotmail.com">gpotai2001@hotmail.com</a>
<b>Tijuana:</b> STD Av Ferrocarril Sonora #3780 L-C Col 20 de Noviembr Tijuana, Mexico	<b>FOR USA SUPPORT:</b> ViewSonic® Corporation 381 Brea Canyon Road, Walnut, CA. 91789 USA Tel: 800-688-6688 E-Mail: <a href="http://www.viewsonic.com">http://www.viewsonic.com</a>



**ViewSonic®**