



Digital Projector User Manual

Portable Series | GP100/GP100A

V 1.05

Product support

You are strongly recommended to upgrade the product to the latest firmware version and refer to the most up-to-date user manual to make best use of the product.

This document aims to provide the most updated and accurate information to customers, and thus all contents may be modified from time to time without prior notice. Please visit the website for the latest version of this document and other product information. Available files vary by model.

1. Make sure your computer is connected to the Internet.
2. Visit the local website from Support.BenQ.com. The website layout and content may vary by region/country. Look for the following regularly to get the most up-to-date information.
 - User manual and related document
 - Firmware and application
 - Frequently asked questions

Servicing

- If misuse or other accident occurs, contact qualified service personnel for servicing.
- Contact your place of purchase or visit the local website from Support.BenQ.com for more support.



Support.BenQ.com

Q&A index

Start with the topics you are interested in:

Setup

How do I set up the projector and turn it on?

Choosing a location	25
Powering on and initial setup	30

Image adjustment

How do I adjust the focus of the projected image?

Adjusting the projection angle	35
Fine-tuning the image clarity	36

How to fit the projected image to the screen?

Keystone	37
Corner Fit	38

Usage

How to start a game with my projector?

Setting to start a game quickly	40
---------------------------------	----

How to watch streaming videos with my projector?

Watching streaming videos	41
---------------------------	----

How to project wirelessly?

Wireless projection	44
---------------------	----

How do I play music via the projector?

Making your projector a wireless speaker	46
--	----

How to play multimedia files on my USB flash drive?

Playing multimedia files from a USB flash drive	49
---	----

Table of Contents

Product support	2
Servicing	2
Q&A index.....	3
Safety instructions.....	8
Package contents.....	13
Introduction	14
Projector overview	14
Overview	14
I/O ports.....	16
Keypad	17
Dimensions.....	18
Projector connections	19
Wireless connection (via ATV dongle).....	19
Wired connection (HDMI port)	19
Wired connection (USB-A port)	19
Wired connection (USB-C port)	19
Remote control (projector remote control only)	22
Remote control effective range	23
Turning remote control backlight on/off	24
Installation	25
Choosing a location	25
Obtaining a preferred image size	27
Projection dimensions.....	27
Installing the ATV dongle	28
Power supply	29
Getting started	30
Powering on and initial setup	30
LED indicator	31
Working with Eye Protection	32

Power menu options	32
Shutting down the projector	33
Upgrading your projector	34
Adjusting the projected image	35
Optimizing the projected image automatically (Smart Auto Settings)	35
Adjusting the projection angle	35
Fine-tuning the image clarity	36
Fitting the image to your screen.....	37
Keystone	37
Corner Fit	38
Zooming an image	38
Changing the input source.....	39
Enhancing gaming experience.....	40
Setting to start a game quickly	40
Charging your console easily during gaming (selected devices only)	40
Watching streaming videos.....	41
ATV home screen.....	41
Choosing a proper picture mode for video streaming.....	42
Customizing a picture mode	42
Choosing a proper sound mode for video streaming.....	42
Customizing a sound mode	43
Projection.....	44
Wireless projection	44
Wired projection.....	44
Playing music by your projector	46
Making your projector a wireless speaker.....	46
Turning the screen off during music playback.....	47
Connect the projector to external Bluetooth Speaker / headphone.....	47

Playing multimedia files from a USB flash drive.....	49
Power delivery to a USB-C device	50
Menu navigation	51
Brightness	52
Picture Mode	52
Sound Mode	53
Picture	54
Power Mode	55
Smart Auto Settings	56
Sound	57
Installation	57
System	59
Maintenance	61
Care of the projector	61
Cleaning the lens.....	61
Storing the projector	61
Transporting the projector	62
Light source information	62
Extending LED life	62
Troubleshooting	63
Specifications	66
Projector specifications	66
Timing chart.....	68
Video timings	70
Supported file formats	71
Appendix.....	72
Working with a tripod (purchased separately)	72
Pairing with a new remote control.....	73
Copyright & disclaimer	74
Copyright	74

Disclaimer	74
Warranty.....	75
Statement regarding hyperlinks and third-party websites	75
BenQ ecoFACTS	76

Safety instructions

Your projector is designed and tested to meet the latest standards for safety of information technology equipment. However, to ensure safe use of this product, it is important that you follow the instructions mentioned in this manual and marked on the product.

1. Please read this user manual before you operate your projector.
Keep this manual in a safe place for future reference.

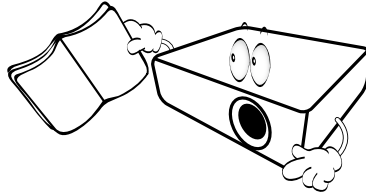

2. Always place the projector on a level, horizontal surface during operation.
 - Do not place the projector on an unstable cart, stand, or table as it may fall and be damaged.
 - Do not place inflammables near the projector.
Do not use if tilted at an angle of more than 10 degrees left to right, nor at angle of more than 15 degrees front to back.

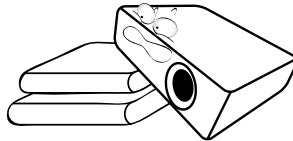

3. Do not store the projector on end vertically. Doing so may cause the projector to fall over, causing injury or resulting in damage.

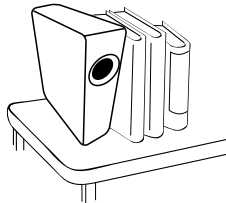

4. Do not place this projector in any of the following environments.
 - Space that is poorly ventilated or confined. Allow at least 50 cm clearance from walls and free flow of air around the projector.
 - Locations where temperatures may become excessively high, such as the inside of a car with all windows rolled up.
 - Locations where excessive humidity, dust, or cigarette smoke may

contaminate optical components, shorten the projector's lifespan and darken the screen.

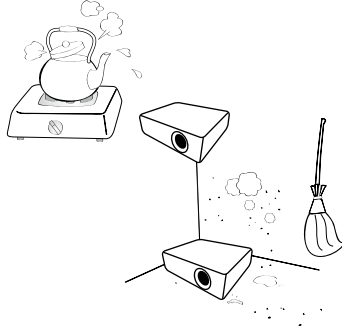

- Locations near fire alarms.
- Locations with an ambient temperature above 40°C /104°F
- Locations where the altitudes are higher than 2000 m (6562 feet).

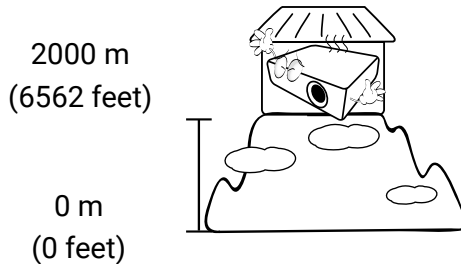

5. Do not block the vents holes while the projector is on (even in power-saving mode).
 - Do not cover the projector with any item.
 - Do not place the projector on a blanket, bedding or any other soft surface.

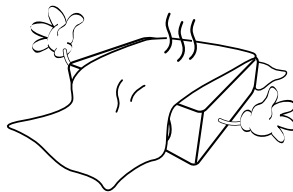

6. In areas where the mains power supply voltage may fluctuate by ± 10 volts, it is recommended that you connect the projector through a power stabilizer, surge protector or uninterruptible power supply (UPS) as appropriate to your situation.

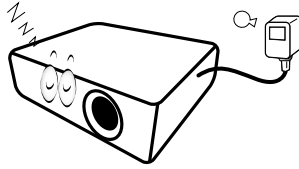

7. Do not step on the projector or place any objects upon it.

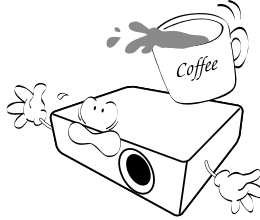

8. Do not place liquids near or on the projector. Liquids spilled into the projector will void your warranty. If the projector does become wet, disconnect it from the power point and call BenQ to have the projector repaired.

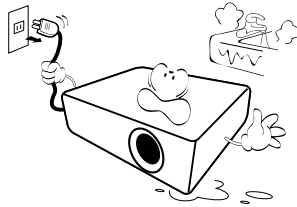

9. Do not look straight into the projector lens during operation. It may harm your sight.

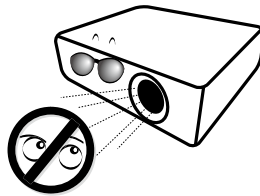

10. Do not operate the projector LED beyond the rated LED life. Excessive operation of LEDs beyond the rated life could cause LEDs to break on rare occasions.

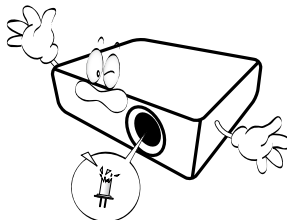

11. Do not attempt to disassemble this projector. There are dangerous high voltages inside which may cause death if you should come into contact with live parts.

Under no circumstances should you ever undo or remove any other covers. Refer servicing only to suitably qualified professional service personnel.

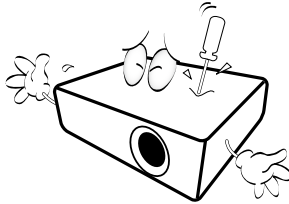

Warning

- Please keep the original packing for possible future shipment.
- If you need to pack your projector after use, adjust the projection lens to an appropriate position, put the lens cushion around the lens, and fit the lens cushion and projector cushion together to prevent damage during transportation.

12. When you think service or repair is required, take the projector only to a suitably qualified technician.

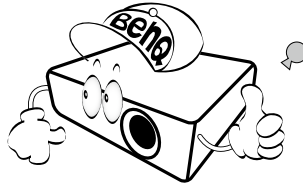

Moisture condensation

Never operate the projector immediately after moving it from a cold location to a hot location. When the projector is exposed to such a change in temperature, moisture may condense on the crucial internal parts. To prevent the projector from possible damage, do not use the projector for at least 2 hours when there is a sudden change in temperature.

Avoid volatile liquids

Do not use volatile liquids, such as insecticide or certain types of cleaner, near the projector. Do not have rubber or plastic products touching the projector for a long time. They will leave marks on the finish. If cleaning with a chemically treated cloth, be sure to follow the cleaning product's safety instructions.

Disposal

This product contains the following materials which are harmful to human bodies and environment.

- Lead, which is contained in solder.

To dispose of the product, consult your local environment authorities for regulations.

Note

- The illustrations and the images shown in this document are for your reference.
- The actual content may vary by the product supplied for your region.

Package contents

Carefully unpack and verify that you have all of the items shown below. Some of the items may not be available depending on your region of purchase. If any of these items are missing, please contact your place of purchase.

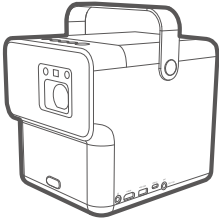

GP100/GP100A



ATV dongle (QS02)

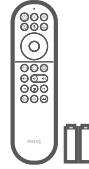

Projector's remote control
(With two AAA batteries)



Quick Start Guide



Screwdriver

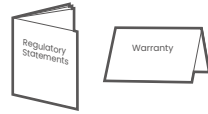

Regulatory statements
& warranty card
(Varies by region)

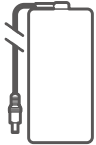

Power adapter



Power cord
(Varies by region)



QR code for
support website

Note

- LED life results will vary depending on environmental conditions and usage. Actual product's features and specifications are subject to change without notice.
- LED replacement is not user-serviceable. When it is needed, please contact the service center.
- Some of the accessories may vary from region to region.
- The warranty card is only supplied in some specific regions. Please consult your dealer for detailed information.
- Use original accessories to ensure compatibility.
- Power cord plug type may change based on regional requirements.

Introduction

Projector overview

Overview

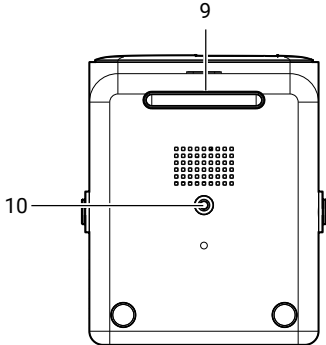
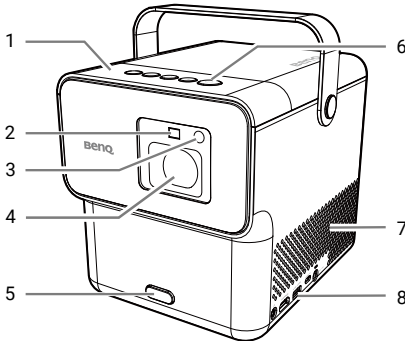

No.	Descriptions
1.	Top cover
2.	Time of Flight (ToF) sensor for auto focus, auto keystone, and eye protection
3.	IR remote sensor
4.	Projection lens
5.	Button of adjustable kickstand
6.	Keypad See "Keypad" on page 17 for details.
7.	Vent (air inlet)
8.	I/O ports See "I/O ports" on page 16 for details.
9.	Adjustable kickstand

No.	Descriptions
10.	Tripod screw hole Used to attach a tripod plate to mount the projector on a tripod. See "Working with a tripod (purchased separately)" on page 72 for details.

I/O ports

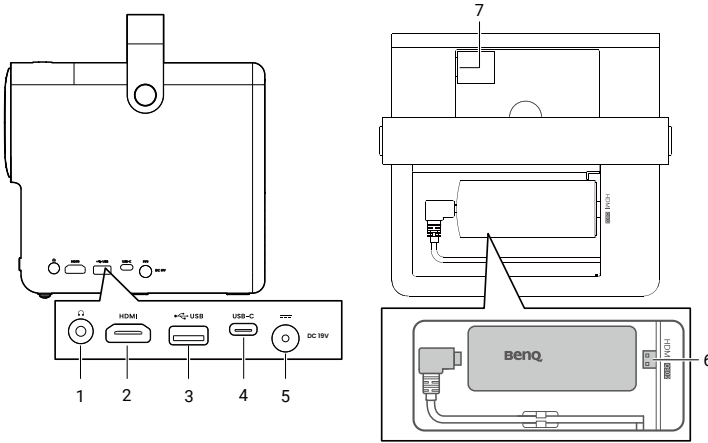

No.	Descriptions
1.	3.5" audio output jack
	HDMI port (Version 2.0b) featuring ARC
2.	<ul style="list-style-type: none">• "Wired connection (HDMI port)" on page 19• "Playing music via a speaker with ARC" on page 47
	USB-A port
3.	<ul style="list-style-type: none">• "Playing multimedia files from a USB flash drive" on page 49• Power supply. See "Specifications" on page 66.
	USB-C port
4.	<ul style="list-style-type: none">• "Wired projection" on page 44• "Power supply" on page 29• "Power delivery to a USB-C device" on page 50
	Note Media reading is not supported.
5.	Power adapter port
6.	Internal HDMI port (exclusively for QS02)
7.	USB-A port (for firmware upgrade)

Keypad

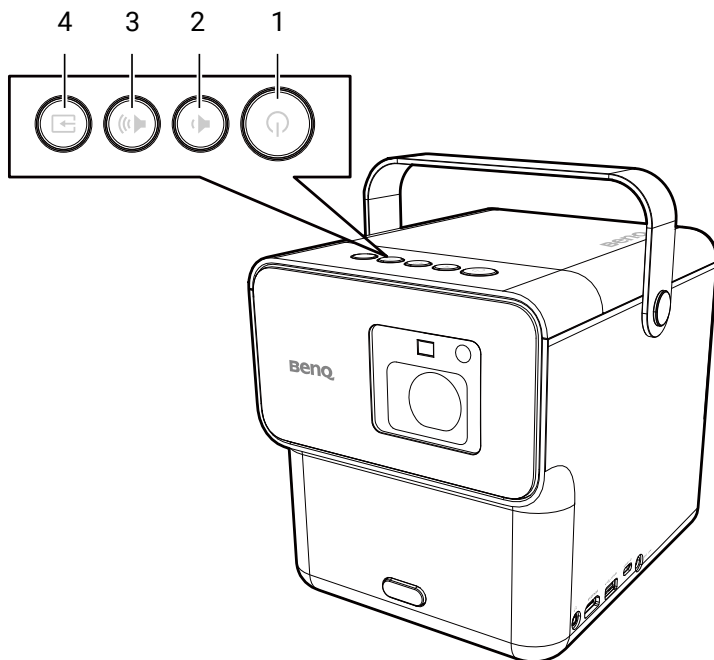

No.	Descriptions
1.	Power key/LED indicator
2.	Volume - key
3.	Volume + key
4.	Input key

Dimensions

169(W) x 213.5(D) x 193(H) mm (without leather hand strap)

180(W) x 213.5 (D) x 250(H) mm (with leather hand strap)

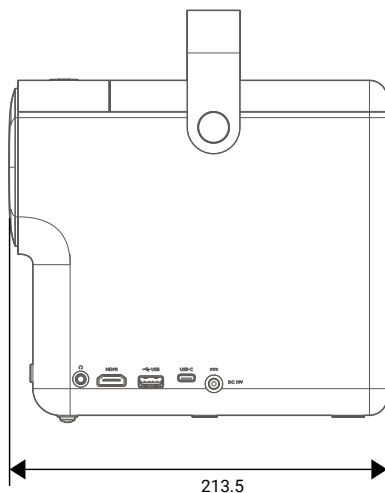
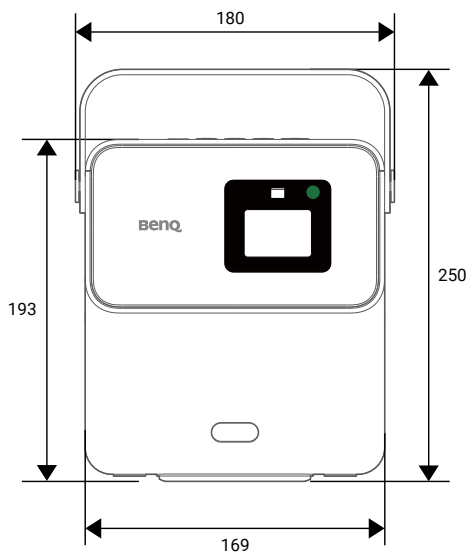

Projector connections

You can connect your device to the projector in various ways to project video content.

Wireless connection (via ATV dongle)

- Smartphone, tablet, laptop/PC (see ["Wireless projection" on page 44](#)).
- Bluetooth devices (speakers, headphone, mouse, etc.)

Before making any wireless connections, be sure to:

- Install the provided ATV dongle for wireless connection.
- Place the projector within range of the wireless AP you plan to connect it to.

Wired connection (HDMI port)

- A/V device.
- Smartphone, tablet, laptop/PC.
- Supports speakers that are ARC-compatible. (See ["Playing music via a speaker with ARC" on page 47](#))

Wired connection (USB-A port)

- USB-A flash drive (See ["Playing multimedia files from a USB flash drive" on page 49](#))

Wired connection (USB-C port)

- Smartphone, tablet, laptop/PC (See ["Wired projection" on page 44](#) for details.)
- Power bank (See ["Power supply" on page 29](#) and ["Power delivery to a USB-C device" on page 50](#) for details.)

Before making any wired connections, be sure to use the correct cable for each source and that it is plugged in securely. Connection with USB-C cables/devices certified by USB-IF may increase compatibility.

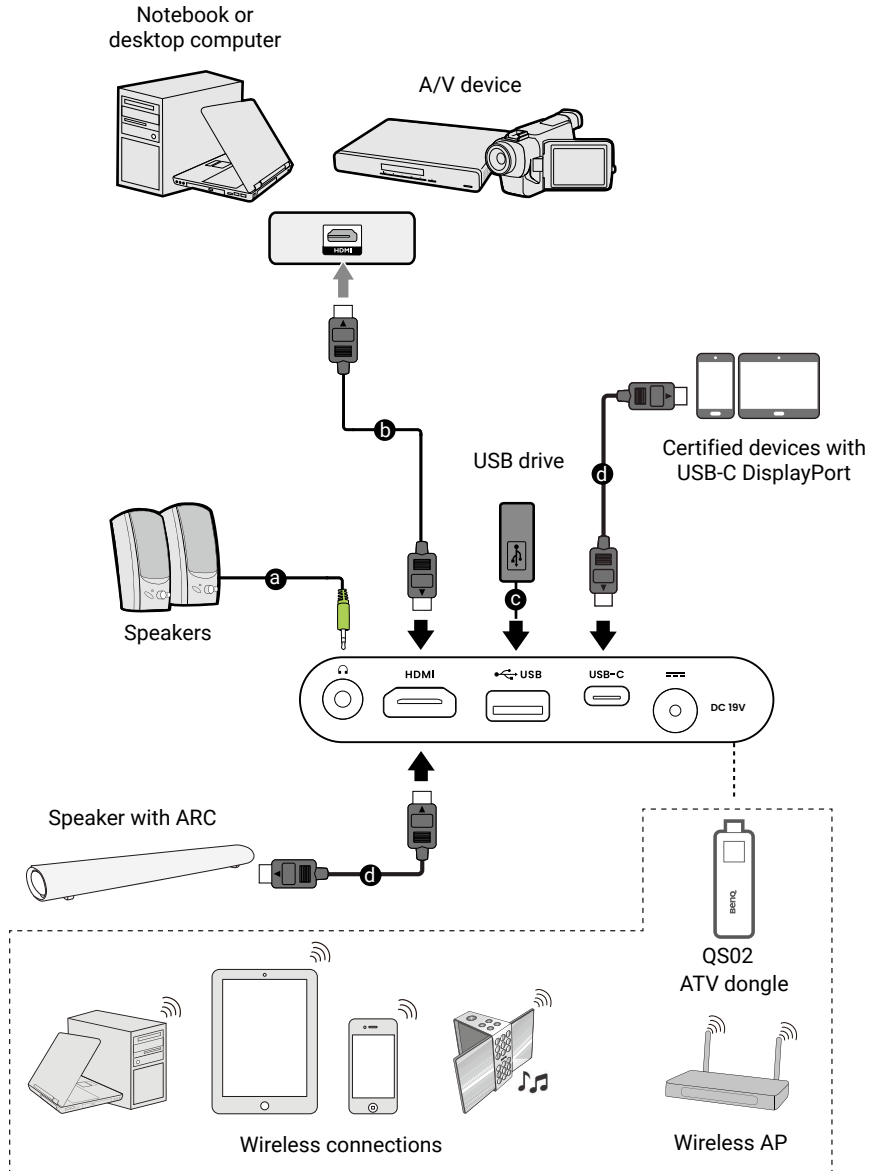

No.	Descriptions	No.	Descriptions
a.	Audio cable	c.	USB flash drive for media reader
b.	HDMI cable	d.	Certified USB-C Cable

Note

- In the connections above, some cables may not be included with the projector (see [“Package contents” on page 13](#)). They are commercially available from electronics stores.
- The connection illustrations are for reference only.
- If the selected video image is not displayed after the projector is turned on and the correct video source has been selected, check that the video source device is turned on and operating correctly. Also check that the signal cables have been connected correctly.
- The built-in speaker(s) will be muted when the AUDIO OUT jack is connected.
- The illustration above is for reference only.

Remote control (projector remote control only)

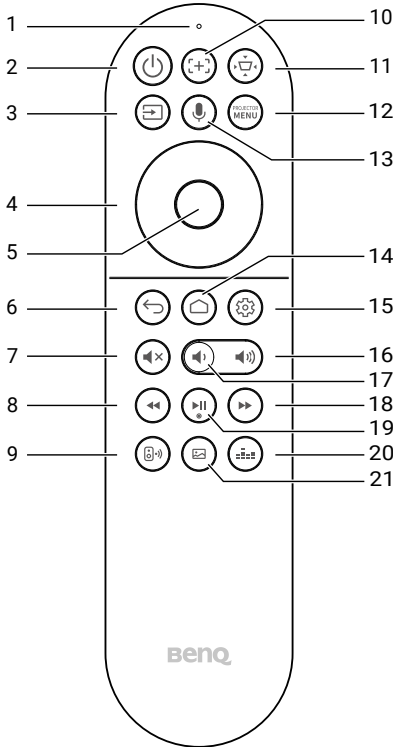

No.	Descriptions
1.	Microphone
2.	Power
3.	Source
4.	Arrow keys
5.	OK

No.	Descriptions
6.	Back
7.	Mute
8.	Rewind
9.	Wireless speaker mode
10.	Focus
11.	Geometry setting: keystone and corner fit
12.	PROJECTOR MENU Projector menu
13.	Voice Search
14.	Android TV home screen
15.	Android TV Settings
16.	Volume up
17.	Volume down
18.	Fast forward
19.	Play/Pause
20.	Sound mode
21.	Picture mode

Remote control effective range

The projector has one IR remote control sensor located at the front of the projector with a range of 8 meters (~26 feet) at an angle of 30 degrees (left and right) and 30 degrees (up and down). Prior to remote control pairing process during the setup wizard (see "[Powering on and initial setup](#)" on [page 30](#)), the remote control can only be used either by pointing it directly at the IR sensor or by reflecting the IR signal off of a wall/screen, making sure that there are no obstacles between the remote control and the IR sensor on the projector.

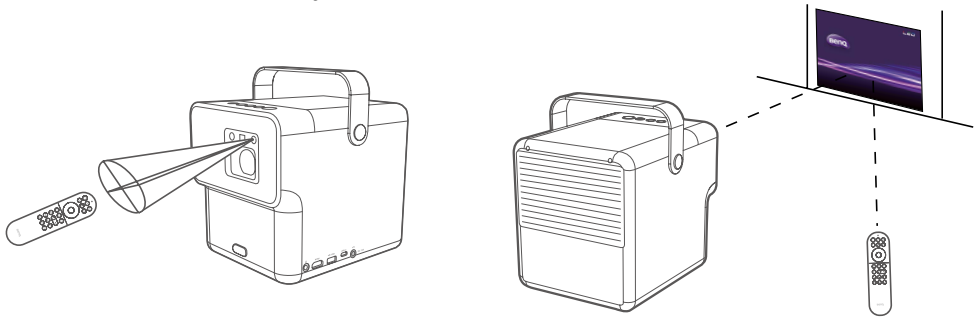



Once the remote control has been paired to the ATV dongle installed in the projector, you will be able to use it at any angle within a range of 8 meters (~26 feet).

Note

Voice search functionality on the remote control is only available after the remote control has been paired to the projector during the setup wizard process. See "[Powering on and initial setup](#)" on [page 30](#) for more details.

Turning remote control backlight on/off

With the remote control backlight, you can see the buttons when they are pressed in the dark.

Press and hold the Mute button  and Volume up button  on the remote control to turn the backlight function on/off. To save battery power, you can turn off the backlight.

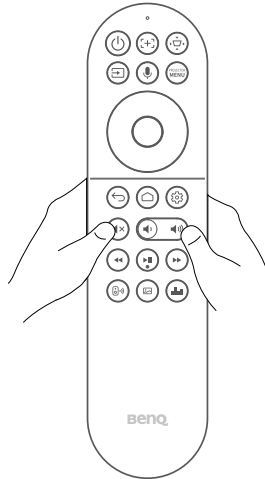

Installation

Choosing a location

Before choosing an installation location for your projector, take the following factors into consideration:

- Size and position of your screen
- Electrical outlet location
- Location and distance between the projector and the rest of your equipment
- Location and distance between the projector and the wireless access point

You can install your projector in the following ways:

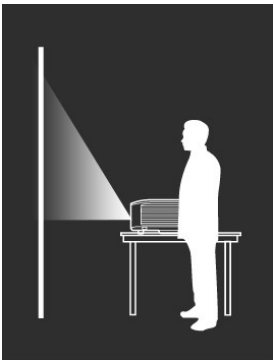
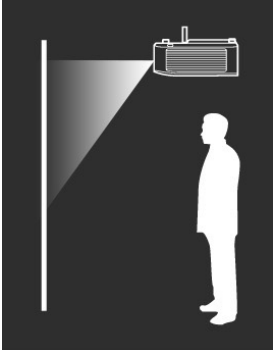
<ul style="list-style-type: none">• Front Table Select this location with the projector placed near the floor in front of the screen. This is the most common way to position the projector for quick setup and portability. Turn on the projector and select the following settings in the projector's settings menu. See "Installation" on page 57 for more details: Installation > Projector Position > Front Table	 A silhouette of a person stands on the right, looking at a vertical screen on the left. A projector sits on a table in front of the screen, projecting a beam of light onto the screen.
<ul style="list-style-type: none">• Front Ceiling Select this location with the projector elevated near the ceiling in front of the screen. Turn on the projector and select the following settings in the projector's settings menu. See "Installation" on page 57 for more details: Installation > Projector Position > Front Ceiling <p>Note</p> <p>The projector does not feature ceiling mount components/equipment. When choosing to use a ceiling location, you must place it on an elevated and even shelf purchased separately. Make sure the shelf is stable enough to support the projector's weight. Secure the shelf properly and keep the projector from falling.</p>	 A silhouette of a person stands on the right, looking at a vertical screen on the left. A projector is mounted on a shelf or ceiling near the top of the screen, projecting a beam of light onto the screen.

- **Rear Table**

Select this location with the projector placed near the floor behind the screen.

Turn on the projector and select the following settings in the projector's settings menu. See "[Installation](#)" on page 57 for more details:

Installation > Projector Position > Rear Table

Note

A special rear projection screen is required.

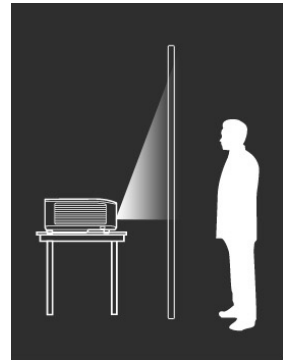

- **Rear Ceiling**

Select this location with the projector elevated from the ceiling behind the screen.

Turn on the projector and select the following settings in the projector's settings menu. See "[Installation](#)" on page 57 for more details:

Installation > Projector Position > Rear Ceiling

Note

- A special rear projection screen is required.
- The projector does not feature ceiling mount components/equipment. When choosing to use a ceiling location, you must place it on an elevated and even shelf purchased separately. Make sure the shelf is stable enough to support the projector's weight. Secure the shelf properly and keep the projector from falling.

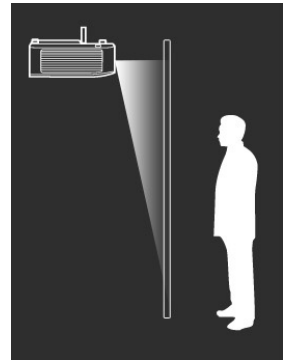

Obtaining a preferred image size

The distance from the projector lens to the screen, the zoom setting, and the video format each factors in the projected image size.

Projection dimensions

The screen aspect ratio is 16:9 and the projected picture is in a 16:9 aspect ratio.

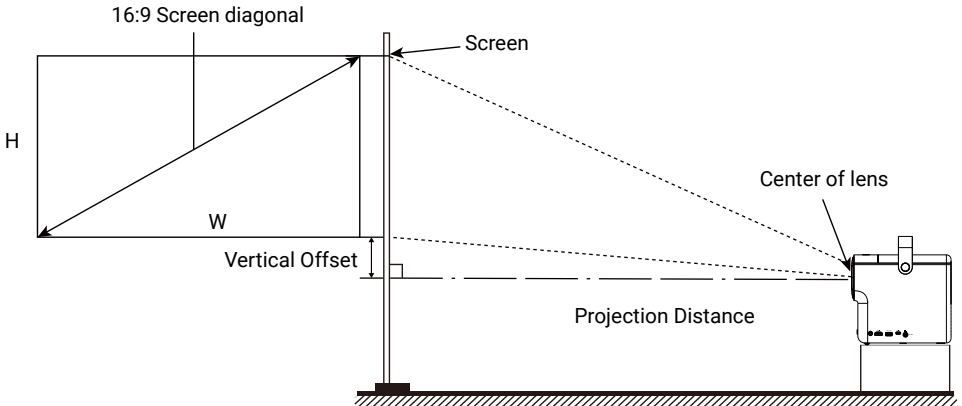

Screen size		W (mm)	H (mm)	Distance from screen (mm)
Inch	mm			
60	1524	1328	747	1590
70	1778	1550	872	1860
80	2032	1771	996	2130
90	2286	1992	1121	2390
100	2540	2214	1245	2660
110	2794	2435	1370	2930
120	3048	2657	1494	3200

For example, if you are using a 120-inch screen, the recommended projection distance is 3200 mm.

If your measured projection distance is 2660 mm, the projected screen size is 100-inch.

Note

All measurements are approximate and may vary from the actual sizes.

BenQ recommends that if you intend to permanently install the projector, you should physically test the projection size and distance using the actual projector in situ before you permanently install it, so as to make allowance for this projector's optical characteristics. This will help you determine the exact mounting position so that it best suits your installation location.

Installing the ATV dongle

1. Remove the cap from the provided ATV dongle.
2. Place the projector on a flat and stable surface covered by a protective sheet with its top cover facing up.
3. Use the supplied screwdriver to release 2 screws counterclockwise as illustrated. Simply loose the screws and the cover can be detached. Do not remove the screws.
4. Remove the top cover from the projector.

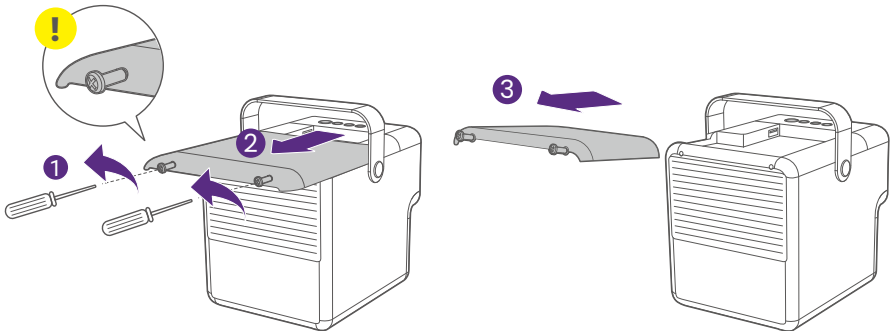

5. Connect the power cable to the port on the side of the dongle (1) and then insert the dongle into the designated HDMI port (2) as illustrated until you hear the clack.

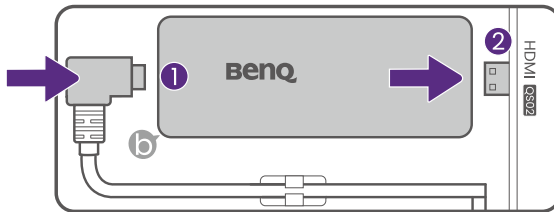

6. Re-install the top cover onto the projector. Use the supplied screwdriver to fix two screws clockwise as illustrated.

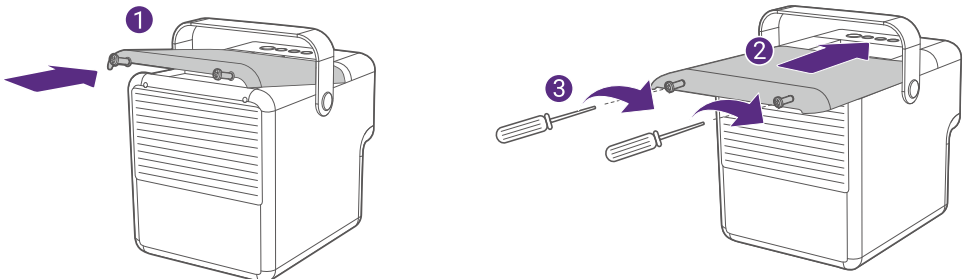

Power supply

Supply power to your projector by one of the following methods.

- (Recommended) Via the provided DC power adapter. The **Power Mode** is switched to **Normal** or the previous mode you set.
- Via a power bank or power adapter with USB-C connector or USB-C cable that are certified by USB-IF. See PD in information in "[Specifications](#)" on page 66 for details. Depending on the power voltage, the projector's **Power Mode** as well as the picture brightness are switched automatically. See "[Power Mode](#)" on page 55 for more information.

Note

- The USB-C port is able to provide power to the connected devices. See "[Power delivery to a USB-C device](#)" on page 50 for more information.
- The USB-A port is able to provide power to the connected devices. See "[Specifications](#)" on page 66 for details.
- Please only use the supplied power adapter to avoid possible dangers such as electric shock and fire.
- Availability of options under **Power Mode** vary by the power voltage supplied to your projector. To have all options available, use the supplied DC power adapter and power cord.

Getting started

Powering on and initial setup

1. Choose a preferred location and image size as instructed in "[Choosing a location](#)" on page 25. Make sure the ATV dongle has been installed. See "[Installing the ATV dongle](#)" on page 28 for more details.
2. Install remote control batteries.
Before you can begin to use the remote control, you must install the supplied batteries into the remote control.
 - Slide the battery cover outwards.
 - Insert the batteries in the orientation shown below.
 - Slide the battery cover back onto the remote control.

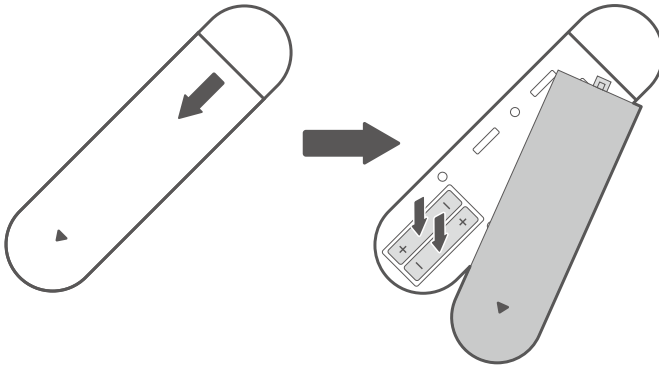

Note

Avoid leaving the remote control and batteries in an excessively hot or humid environment like the kitchen, bathroom, sauna, sunroom or in a closed car.

3. Connect power to the projector.
Press and hold the power button  on the projector or the remote control for 1 second. The power LED will flash green slowly.

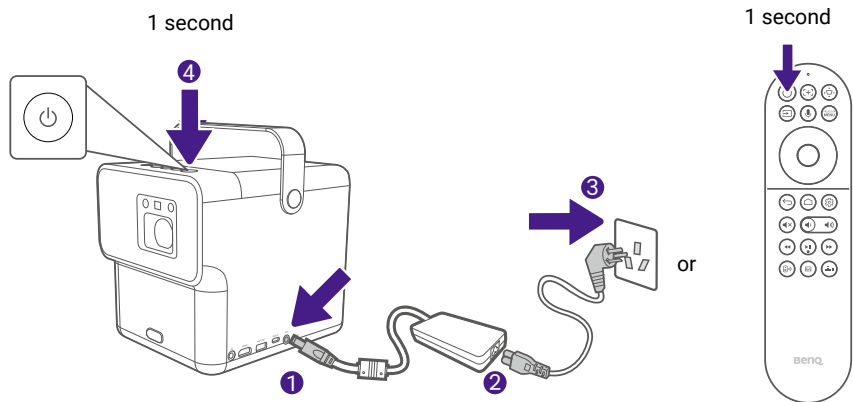

Note

- When supplying power directly to the projector via the supplied power adapter, please use the supplied power cable to avoid possible dangers such as electric shock and fire.
- Prior to pairing the remote control to your projector you must ensure that your remote control is in range of the projector's IR sensor. See "[Remote control effective range](#)" on page 23 for more details.

4. Power on the projector and follow the on-screen instructions to complete the initial setup. When you're prompted to set up your remote, select "**Not now**" to proceed. You can refer to QS02 user manual from Support.BenQ.com for more information.
5. Check if an updated firmware is available to your product. Refer to "[Upgrading your projector](#)" on page 34.
6. Go for a preferred scenario.
 - "[Enhancing gaming experience](#)" on page 40
 - "[Watching streaming videos](#)" on page 41
 - "[Projection](#)" on page 44
 - "[Playing music by your projector](#)" on page 46

LED indicator

Scenario	LED status	Power status
Turning on/off	Flashing green	Turning on/off properly
Powered-on	Solid green	Working properly
	Solid yellow	In power saving or audio-only mode
Powered-off	Solid red	Powered-off

Working with Eye Protection

This function reduces the screen brightness when an object is within 3.2 meters in front of the projection lens. You can choose to blank the screen if desired.

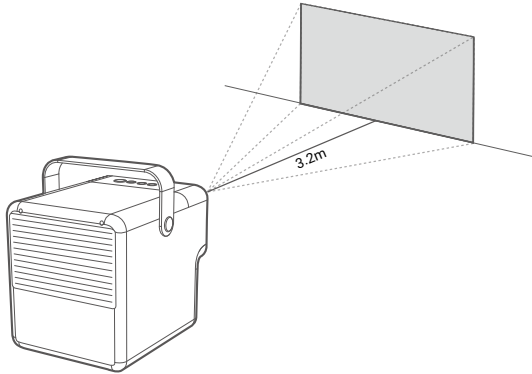

Note

- This function is not designed for side projection and may not work properly when the projection angle is over 20 degrees. Turn off eye protection function if desired.
- Eye protection function may be triggered for a few seconds when moving the projector.

Power menu options

Press the  button on the remote control or projector to bring up the power menu.

Item	Description
Power Off	Sets to power off the projector.
Audio-Only Mode	Sets to turns off the screen while the music playback continues. See "Turning the screen off during music playback" on page 47 for more information.
Power Saving	Sets the projector and the ATV dongle to power saving mode when they are not in use. To disable Power Saving mode, press the  button.

Shutting down the projector

Press and hold the power button  on the projector or remote control for over 3 seconds and the projector will shut down. Wait until the LED turns solid red. The fans may continue to run in order to cool the system. If the projector will not be used for an extended period, unplug the power cable from the power outlet and remove the batteries from the remote control.

Note

Short pressing the power button on the projector or remote control will trigger a shutdown confirmation box. Under this condition, press the power button again to shut down the projector.

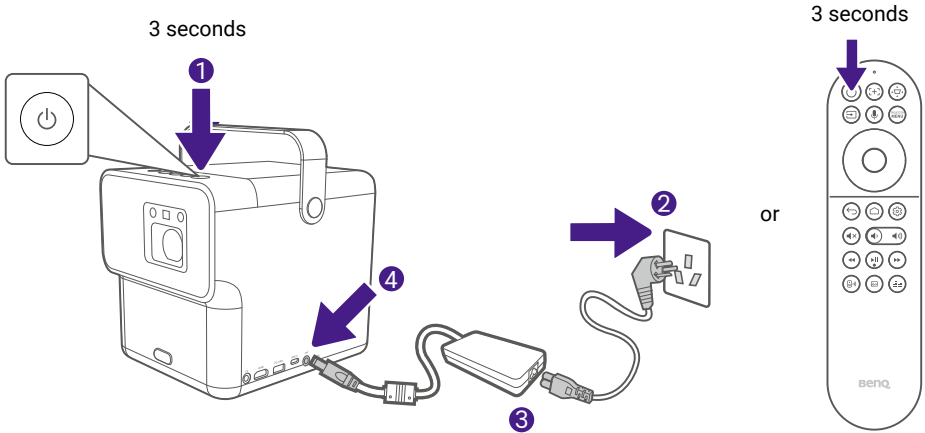

Upgrading your projector

It is suggested that you update the projector with the latest version of the firmware to optimize the user experience.

How-to video



[Firmware upgrade](#)

1. Visit Support.BenQ.com and download the new firmware files (if available) of your projector. Save the firmware files to a USB flash drive in FAT32 disk format. You should download the latest user manual for reference as well.
2. Keep stable power supply to the projector via power adapter. Do not power off the projector.
3. Connect the USB flash drive to the USB port exclusively for projector firmware upgrade. You should remove the projector cover to access the USB port.
4. Go to **System > System Update > USB Update** on your projector to start the upgrade. Wait until you are instructed to complete the initial setup. The upgrade is complete.

Note

Check if there are updated firmware files and user manual of QS02 ATV dongle from Support.BenQ.com. Find out the updates from the upgrade notice. If a new firmware version is available, you are recommended to upgrade the dongle for best performance.

Adjusting the projected image

Optimizing the projected image automatically (Smart Auto Settings)

As the projector is portable/movable, you might want to move the projector to a desired place to meet your scenario. With **Smart Auto Settings**, you don't need to go through each picture setting manually for adjustment.

1. To optimize the projected image quickly and automatically, go to **Smart Auto Settings** on your projector.
2. Set **Auto Focus** and **Auto 2D Keystone** settings to **On**. The effective distance from the projection lens to the screen is 3.2 meters.

Adjusting the projection angle

The button of adjustable kickstand allows you to adjust the projection angle.

To adjust the projection angle:

1. Lift the front of the projector and press the button of adjustable kickstand.
2. Adjust the appropriate projection height and place the projector horizontally.

To retract the adjustable kickstand, press the button, then slowly lower the projector.

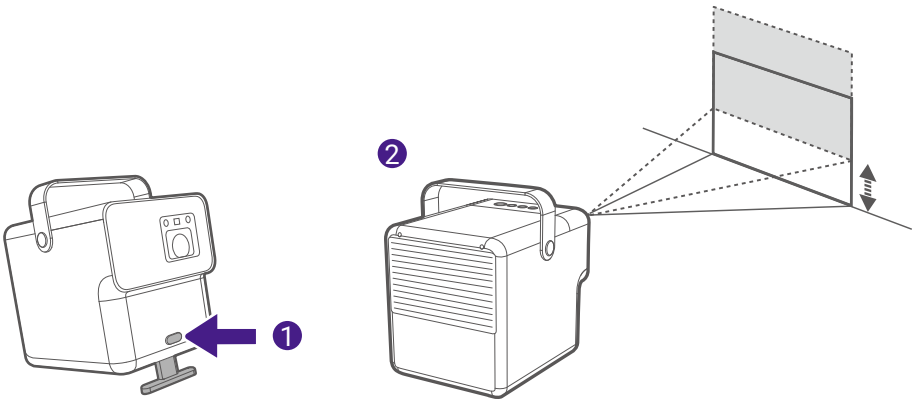

Note

- The maximum angle of adjustment is 12 degrees.
- If the screen and the projector are not perpendicular to each other, the projected image becomes trapezoidal. To correct this, see "[Keystone](#)" on page 37 for details.
- When the projector is on, DO NOT place down the projector with its back vents facing down as this will block the vents.

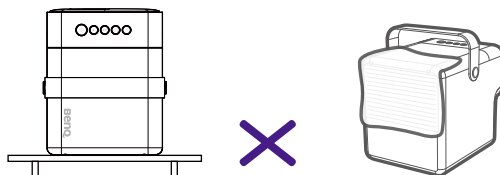

Fine-tuning the image clarity

To sharpen the picture, adjust the focus. The effective distance from the projection lens to the screen is 3.2 meters for auto focus.

- **Realtime auto focus:** when the projector is moved or the projection distance is changed, the function will be performed automatically.
- **Auto focus:** press the focus button **[+]** on the remote control or go to **Smart Auto Settings** or **Installation** > **Focus Settings** > **Auto Focus**. A focus guide is displayed and the focus is adjusted automatically. When the focus is completed, press **[↵]** to leave.
- **Manual focus:** press the focus button **[+]** on the remote control and the projector will automatically focus the image first. Press the left **[◀]** or right **[▶]** buttons on the remote control to manually adjust the focus. When the focus is completed, press **[↵]** to leave. Follow the on-screen instructions to save the current focus setting for future use.

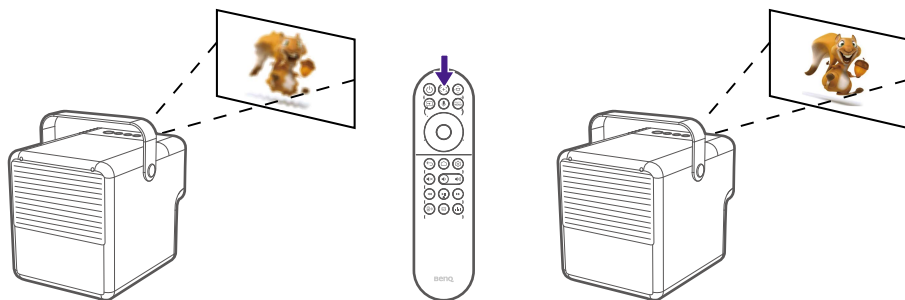

Note

Do not look into the lens while the light is on. The strong light from the lens may cause damage to your eyes.

Fitting the image to your screen

You are provided with several ways to adjust the image and to fit the screen clearly. Depending on the layout of your room, choose one that fits your need. The effect is up to the last adjustment you made.

Keystone

The keystone effect refers to the situation where the projected image is noticeably wider at the top / bottom / left / right. It occurs when the projector is not perpendicular to the screen. The screen automatically performs keystone correction as the projector moves.

- **Auto 2D Keystone:** Available from **Smart Auto Settings** or **Installation > Geometry Setting**. When the projector is moved or the projection angle is changed, the function will be performed automatically. The effective distance from the projection lens to the screen is 3.2 meters.
- **Manual Keystone:** Available from  button on the remote control or from **Installation > Geometry Setting**. Simply follow the on-screen instructions to make adjustments.

When you are done making the adjustments, press  to save your changes and return to the previous menu.

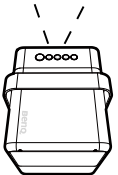
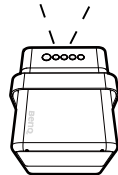
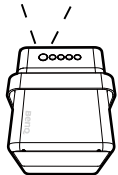
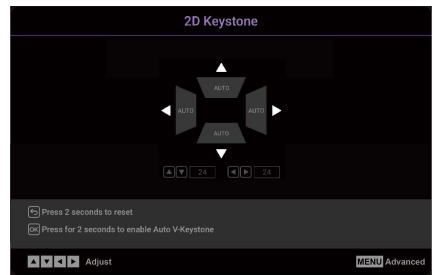
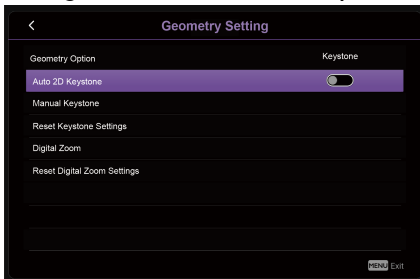

Corner Fit

Adjust when the four corners of the projected image are distorted.

1. Press the **PROJECTOR MENU** button on the remote control to enter the projector's settings menu.
2. Go to **Installation > Geometry Setting > Corner Fit Adjustment**.
3. Choose one of the corners you want to adjust and then follow the on-screen instructions to correct the image.

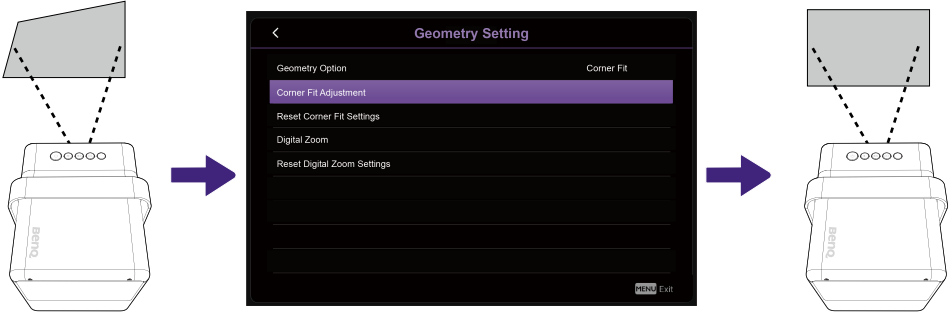

Zooming an image

Zoom an image to change the size of the display content.

1. Press the **PROJECTOR MENU** button on the remote control to enter the projector's settings menu.
2. Go to **Installation > Geometry Setting > Digital Zoom**.
3. Press the ◀▶ keys to adjust the screen to zoom in/out.

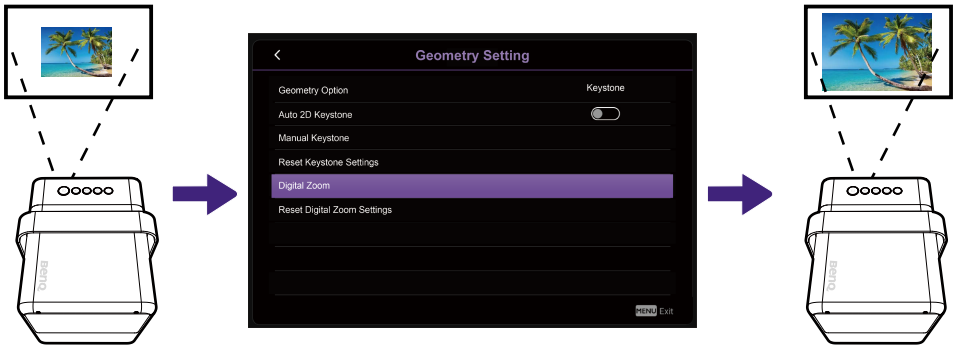

Changing the input source

By default, the projector will enter the **Android TV** interface after it is powered on the first time. Once powered on, when a device is connected to one of its input ports the projector will automatically switch over to that input source.

To switch between input sources and **Android TV**, press the source button  on the remote control and select the desired input source from the source menu.

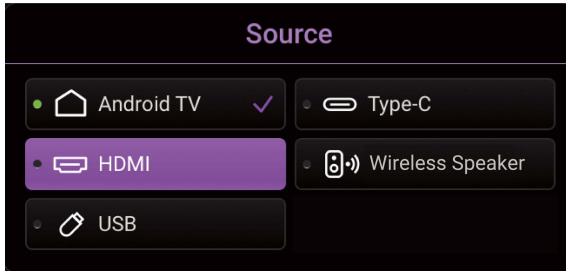

You can also press the home button  on the remote control to return to the **Android TV** home screen at any time.

Enhancing gaming experience

Setting to start a game quickly

To enhance your gaming experience, you are provided with picture and sound modes that are suitable for gaming.

1. Go to **Smart Auto Settings** or **System** to enable **Auto Game Mode**. This setting helps to switch to a connected gaming source (e.g., Nintendo Switch, PS5, Xbox Series S) and modes designed for gaming automatically.
2. If you prefer low latency, follow on-screen instructions. Set **Keystone** to **0**, and set **Aspect Ratio** to **Auto**.

Charging your console easily during gaming (selected devices only)

Your projector features video/audio transfer and power delivery from the USB-C port. With this feature, you can charge your gaming console (with USB-C video output) directly during gaming without any other docking. For more information on USB-C power delivery, see ["Power delivery to a USB-C device" on page 50](#).

Watching streaming videos

Make sure the ATV dongle (QS02) has been installed and connected to a wireless network properly. **Android TV** is the projector's operating system that allows you to project videos wirelessly and use streaming apps.

Note

For the ATV dongle (QS02) user manual, visit Support.BenQ.com.

ATV home screen

Upon initial startup or when the input source is set to ATV the projector will display the **Android TV** interface. If the projector is projecting from a source, you can return to **Android TV** by pressing the  key on your remote control or by selecting ATV in the input source menu.

The **Android TV** home screen features following items:

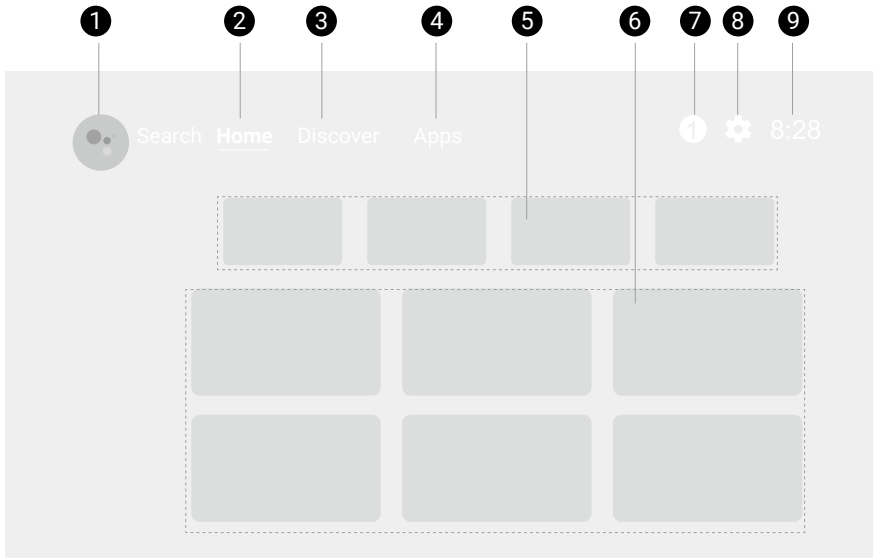

Note

Actual screen may vary based on your **Android TV** version.

No.	Item	Description
①	Google Assistant	Press the Google Assistant button on your remote control to talk to Google.
②	Home	Access to Android TV Home screen.
③	Discover	Access to personalized recommendations.

No.	Item	Description
4	Apps	Access to all the installed apps and Google Play.
5	Recommended apps/My favorites	<ul style="list-style-type: none"> • Access to the recommended apps or video on demand services. • Access to the apps that have been added to favorites by the Bookmark key.
6	Recommended content	Access to the content recommended by the specified channel/streaming service.
7	Notification	Access to notifications.
8	Settings	Access to Android settings menus.
9	System time	Displays the time.

Choosing a proper picture mode for video streaming

You are provided with a variety of picture modes for different scenarios in **Picture Mode**. Press the  button on the remote control for options. Usually **Cinema** and **Living Room** are recommended for watching movies. HDR/HLG options are available if HDR/HLG content is available. See "[Picture Mode](#)" on page 52 for more information.

Customizing a picture mode

You can customize a **Picture Mode** as desired.

1. Go to **PROJECTOR MENU > Picture Mode > User**.
2. Adjust the picture settings as desired.
3. Press  on the remote control to save the changes and exit.

To apply the customized **Picture Mode**, press the  button on the remote control and select **User**.

Note



Press **Picture > Reset Picture Settings** to reset pictures settings to factory defaults.

Choosing a proper sound mode for video streaming

In general, you can select a sound mode from **Sound Mode** to suit your

scenario. Press the  button on the remote control for options. As **Cinema** is recommended for movie watching, more options are provided to enhance your cinematic experience. See "[Sound Mode](#)" on page 53 for more information.

Customizing a sound mode

1. Go to **PROJECTOR MENU > Sound Mode > User**.
 2. Adjust the frequency as desired.
 3. Press  on the remote control to save the changes and exit.
- To apply the customized sound mode, press the  button on the remote control and select **User**.

Note

Press **Sound > Reset Audio Settings** to reset audio settings to factory defaults.

Projection

Wireless projection

Wireless projection is available only after the supplied ATV dongle (QS02) is installed, and the projector and your device are connected to the same wireless network. Refer to the QS02 user manual from [Support.BenQ.com](https://support.benq.com) or scan the following QR code for instructions on how to perform wireless projection.

How-to video



[Wireless projection](#)

Wired projection

Using an HDMI or certified USB-C 3.0 cable you can connect a device that is equipped with HDMI or DisplayPort capabilities to broadcast videos and images on the projector.

Warning

Connections with other devices are made by certified HDMI or USB-C cables only.

Note



Not all devices with a USB-C port have DisplayPort functionality. Check your device's documentation for clarification. The USB-C port on this projector cannot support media reader (i.e., it cannot access files stored on a flash storage drive).

To connect a device with HDMI or USB-C with DisplayPort:

1. Connect the device to the HDMI or USB-C port on the projector with a certified cable. A pop-up notification will appear indicating that a device is connected.
2. Confirm whether you want to project video from the device. The video from the device will be displayed once the signal from the device is detected.

Note

If no signal is detected or the signal is interrupted, a message will appear. Check cable connection again.

3. Use the source menu or press the home button  to exit and go back to the **Android TV** home screen.
4. If the device remains connected and you want to project its video again, press the source button , and then select the corresponding port in the source menu.



Note

- Some computers feature HDMI ports that do not transmit audio, in such cases a separate audio cable must be connected to the projector.
- Some laptops do not turn on their external video ports when connected to a projector. Usually a key combination like Fn + F3 or CRT/LCD key turns the external display on/off. Locate a function key labeled CRT/LCD or a function key with a monitor symbol on the laptop. Press Fn and the labeled function key simultaneously. Refer to your laptop's documentation to discover your laptop's key combination.

Playing music by your projector

With the built-in speakers, you can enjoy music playback via the projector without a projection screen. The projector can work as an ordinary speaker or a wireless speaker.

Making your projector a wireless speaker

1. Make sure the ATV dongle is installed properly (see "[Installing the ATV dongle](#)" on page 28).
2. Power on the projector (see "[Powering on and initial setup](#)" on page 30).
3. Press the wireless speaker mode  button on the remote control or press the input source  button > **Wireless Speaker**. The projector will stop projecting and switch over to wireless speaker mode.
4. Connect your mobile device and the projector (with QS02 ATV dongle installed) to the same wireless network.
5. Launch the music app on your mobile device and use the casting function through Chromecast. Find QS02 as the casting device to enjoy music streaming.

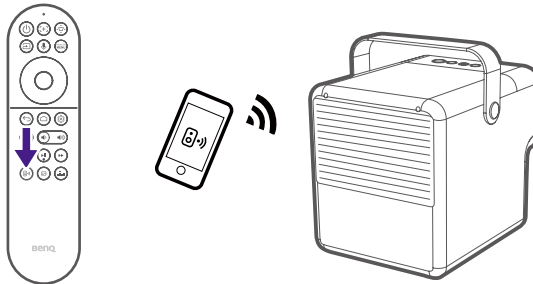

Turning the screen off during music playback

You can enjoy music playback via the projector without a projection screen.

Press the  button on the remote control or projector, and select the **Audio-Only Mode** to switch the projector to audio-only mode. The screen is turned off while the music playback continues.

To stop the playback or to perform other operations, press any key on the remote control to bring the projection screen back.

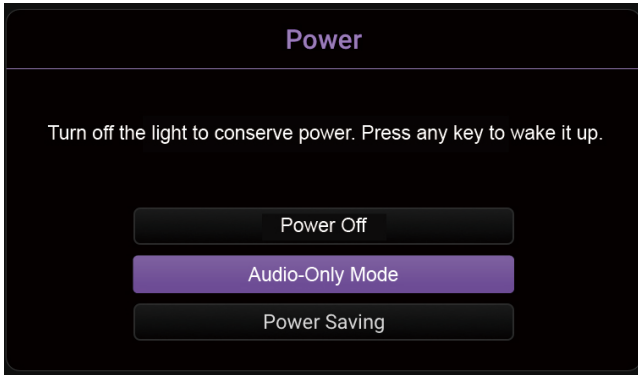

Playing music via a speaker with ARC

The HDMI port on the projector features Audio Return Channel (ARC) capabilities which allows it to output its audio to an ARC-compatible speaker connected via an HDMI cable.

1. Connect the ARC-compatible speakers to the projector via HDMI cable.
2. Disconnect other external speakers connected via Bluetooth or 3.5mm audio jack.

Connect the projector to external Bluetooth Speaker / headphone

Available only when the input source is ATV

1. Make sure the ATV dongle is installed properly (see ["Installing the ATV dongle" on page 28](#)).
2. Power on the projector (see ["Powering on and initial setup" on page 30](#)).
3. Press the  button on the remote control.

4. Select **Remotes & Accessories**.
5. Select **Add Accessory**.
6. Activate Bluetooth-pairing mode on the speaker or headphones.
7. Select the speaker or headphones from the device list shown on screen.
8. Select **Pair**.

When the projector and speaker or headphones have successfully connected, the device will be labelled as connected in the **Network & Internet**. You can now output the audio from the ATV to the speaker or headphone.

Note

- This function is available only when the input source is ATV. Even when the projector is switched to other input sources, such as HDMI, as ATV is still running in the background, it will continue to transmit audio from ATV to the connected Bluetooth speaker or headphones.
- The projector does not support automatic re-connections with previously paired devices. In order to re-connect to a paired device or connect to another device, repeat the steps above.

Playing multimedia files from a USB flash drive

To play media files stored on a USB flash drive, you must make connections and settings properly.

1. Make sure the ATV dongle is installed properly (see ["Installing the ATV dongle" on page 28](#)).
2. Connect your USB flash drive to the USB-A port on the left side of the projector.
3. Press the source button  on the remote control and select **USB** in the source menu.
4. Follow the on-screen instructions. Click **Apps** from the ATV home screen.

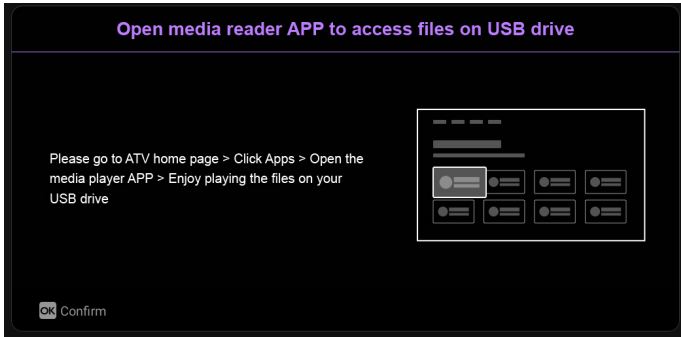

5. Launch a media reader app to access the multimedia files stored on your USB flash drive. Supported file formats for playback may vary by app.

Power delivery to a USB-C device

With the power delivery function, your projector is able to supply power to a connected USB-C device certified by USB-IF.

Supported USB-C power delivery output:

- 5V/1.5A
- 9V/1.5A
- 12V/1.5A
- 15V/1.2A

USB-C power delivery notice

- The information is based on the standard testing criteria and is provided for reference. The compatibility is not guaranteed as the user environments vary. When a separately purchased USB-C cable is used, make sure the cable is certified by USB-IF and is full-featured, with power delivery function.
- A connected device needs to be equipped with a USB-C connector that supports charging function via USB power delivery.
- If the connected device requires more than the power supplied by your projector for operation or for boot up (when the battery is drained), use the original power adapter that came with the device.

Menu navigation

To let you make various adjustments or settings on the projector, the projector provides a settings menu. To access the menu, press the PROJECTOR **MENU** button on the remote control.

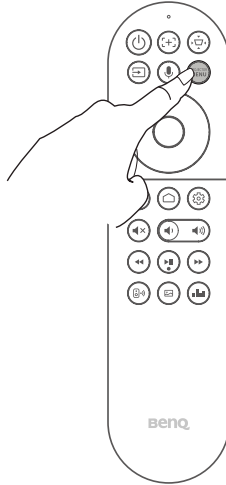

Note

For settings related to the system including wireless connection, account, and app related setting, use the **Android TV** Settings menu accessible on the home screen. See "[ATV home screen](#)" on page 41 for more details.

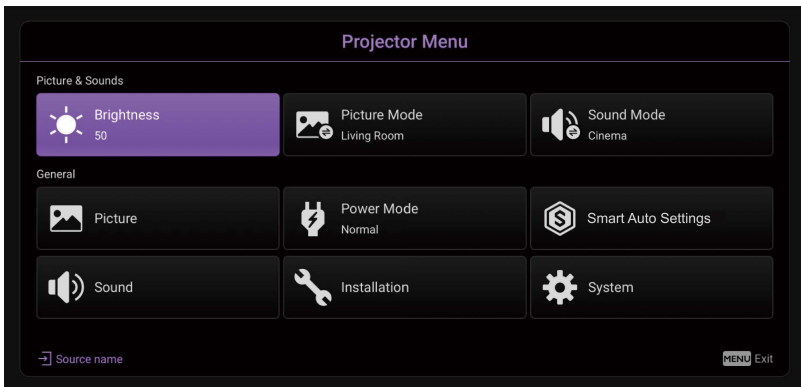

Brightness

Allows you to adjust the brightness of the projector on a scale of 0 to 100.

Picture Mode

Item	Options and descriptions
Bright	Maximizes the brightness of the projected image. This mode is the brightest mode on your projector.
Living Room	With well-saturated colors and fine-tuned sharpness, this mode is slightly brighter than Cinema mode and suitable for playing TV streaming under a small amount of ambient light.
Game	Picture settings appropriate for playing party video games which often composed by vivid color arrangement. This mode especially enhances details in dark scenes while keeping accurate colors at the same time. Note If you prefer low latency, follow on-screen instructions. Set Keystone to 0 , and set Aspect Ratio to Auto .
Sports	With well-saturated colors, this mode is best for watching sporting events.
Cinema	With accurate colors and deepest contrast at a lower brightness level, this mode is suitable for playing movies in an environment with a bit of ambient light.
Day time	By brightening dim regions of images, this mode is suitable for use in lit spaces.
User	Accesses the customized settings.
HDR Cinema	Provides a high dynamic range effect for images in Cinema mode, with higher contrasts of brightness and colors.

Item	Options and descriptions
HDR Living Room	Delivers High Dynamic Range effects with higher contrasts of brightness and colors. With well-saturated colors and fine-tuned sharpness, this mode is suitable for playing TV streaming under a small amount of ambient light.
HDR Game	<p>Provides a high dynamic range effect for images in Game mode, with higher contrasts of brightness and colors.</p> <p>Note If you prefer low latency, follow on-screen instructions. Set Keystone to 0, and set Aspect Ratio to Auto.</p>

Sound Mode

Item	Options and descriptions
Cinema	This mode emphasizes low frequency sound effect, just like ideal movie theater, the audience is surrounded by deeper cinematic bass. This mode balances the background music and movie sound effect and especially enhances stereo bass sound effect for explosive action scene, such as gunshots and firefights. That's why this mode is suitable for various type of movies, such as serious drama, musical and comedy.
Music	This mode emphasizes total balance (low, middle, high frequency) to fully display the timbre of musical instrument, rhythm of symphony and solos of singer in the hot concert or in live hall for different type of music, like pop, rock, and jazz. To reproduce immersive atmosphere or the presence of sound stage, this mode especially enhances the beat of rhythm instruments, the stereo sound space and the vividness of singer.
Game	This mode not only emphasizes clear position and spatial dynamic to enhance directional sound but also optimizes the mid-high frequency sound effect which is common in party games.

Item	Options and descriptions
Sports	This mode allows you to enjoy the rich vividness of sport broadcasts and light entertainment programs. The commentators' voice is clear and high pitch shrill cheers from the audience is processed.
User	In this mode you can adjust frequency setting according to your needs.

Picture

Item	Options and descriptions
Picture Mode	The projector is preset with several predefined picture modes so that you can choose one to suit your operating environment and input signal picture type. See "Picture Mode" on page 52 for details.
Brightness	The higher the value, the brighter the image. Adjust this control so the black areas of the image appear just as black and that detail in the dark areas is visible.
Contrast	The higher the value, the greater the contrast. Use this to set the peak white level after you have previously adjusted the Brightness setting to suit your selected input and viewing environment.
Color	Lower setting produces less saturated colors. If the setting is too high, colors on the image will be overpowering, which makes the image unrealistic.

Item		Options and descriptions
Tint		The higher value, the more reddish picture is. The lower value, the more greenish picture is.
Sharpness		The higher the value, the sharper the picture becomes.
CinemaMaster	Flesh Tone	Provides a smart adjustment of hue only for calibrating people's skin color, not other colors in the image. It prevents discoloration of skin tones from the light of the projection beam, portraying every skin tone in its most beautiful shade.
	Noise Reduction	Reduces electrical image noise caused by different media players.
	Contrast Enhancer	Enhances contrast to view more details in dark scenes.
Reset Picture Settings		You can reset to factory defaults.

Power Mode

Item		Options and descriptions
Normal		100% LED brightness.
Eco		This setting reduces system noise and power consumption by 30%. If Eco mode is selected, the light output will be reduced and result in darker projected pictures.
Low Power Consumption		Lowers brightness to 50% to extend the LED life.
(Available if power is supplied via USB-C port)		
USB-C Normal		Available when the power supply is at least USB-C PD 100W(20V/5A).

Item	Options and descriptions
USB-C Eco	Available when the power supply is at least USB-C PD 60W(20V/3A).
USB-C Low Power Consumption	Available when the power supply is at least USB-C PD 45W(20V/2.25A).

Note

Availability of options under **Power Mode** vary by the power voltage supplied to your projector. To have all options available, use the supplied DC power adapter and power cord.

Smart Auto Settings

Item	Options and descriptions
Auto Focus	Sharpens the image quality. Once enabled, when the projector is moved or the projection distance is changed, the function will be performed instantly.
Auto 2D Keystone	Corrects image keystone when it is noticeable wider at the top / bottom / left / right. Once enabled, when the projector is moved or the projection angle is changed, the function will be performed instantly.
Auto Game Mode	Once enabled, the projector detects a connected gaming source and switch to modes designed for gaming automatically.
Auto Eye Protection	Once enabled, the projector reduces the screen brightness when an object is within 3.2 meters in front of the projection lens. See " Working with Eye Protection " on page 32 for more information.

Sound

Item	Options and descriptions
Sound Mode	Sound Mode utilizes sound enhancement technology, which incorporates Waves' algorithms to deliver great effects of the bass and treble and provide you with immersive cinematic audio experience. See " Sound Mode " on page 53 and " Customizing a sound mode " on page 43.
100Hz	Displays the frequency band information of each sound mode. If Sound Mode is set to User , you can adjust frequency as desired. See " Customizing a sound mode " on page 43 for more information. Select desired frequency bands to adjust the levels according to your preference. The settings made here define the User mode.
300Hz	
1KHz	
3KHz	
10KHz	
Reset Audio Settings	You can reset to factory defaults.

Installation

Item	Options and descriptions
Projector Position	Chooses the position in which the projector is installed. See " Choosing a location " on page 25 for more details.
Geometry Setting	Allows you to adjust Keystone and Corner Fit . See " Keystone " on page 37 and " Corner Fit " on page 38 for more information.
Focus Settings	Allows you to further configure the projector's auto focus function.
Eye Protection	Reduces the screen brightness or blanks the screen when an object is within 3.2 meters in front of the projection lens. See " Working with Eye Protection " on page 32 for more information.

Item	Options and descriptions
Test Pattern	Displays the test pattern grids, which helps you adjust the image size and focus to check if the projected image is free of distortion.
HDMI settings	<p>Allows you to further configure HDMI settings.</p> <ul style="list-style-type: none"> • HDMI Format: Selects a suitable color format to optimize display quality. • HDMI EDID: Switches the HDMI EDID between Enhanced or Standard in order to solve compatibility issue with certain old players.
Aspect Ratio	<p>There are several options to set the image's aspect ratio depending on your input signal source.</p> <ul style="list-style-type: none"> • Auto: Scales an image proportionally to fit the projector's native resolution in its horizontal or vertical width. • Real: Projects an image as its original resolution and resizes it to fit within the display area. For input signals with lower resolutions, the projected image will be displayed in its original size. • 4:3: Scales an image so that it is displayed in the center of the screen with a 4:3 aspect ratio. • 16:9: Scales an image so that it is displayed in the center of the screen with a 16:9 aspect ratio.

Item	Options and descriptions
High Altitude Mode	<p>We recommend you use the High Altitude Mode when your environment is between 1500 m - 2000 m above sea level, and ambient temperature is between 0°C to 30°C.</p> <p>Operation under High Altitude Mode may cause a higher decibel operating noise level because of increased fan speed necessary to improve overall system cooling and performance.</p> <p>If you use this projector under other extreme conditions excluding the above, it may display auto shut-down symptoms, which is designed to protect your projector from over-heating. In cases like this, you should switch to High Altitude Mode to solve these symptoms. However, this is not to state that this projector can operate under any and all harsh or extreme conditions.</p>

System

Item	Options and descriptions
Language	Sets the language for the projector.
Auto Source Search	Allows the projector to automatically search for a signal.
Auto Game Mode	When video game consoles are detected, Picture and Sound Mode will automatically switch to optimized gaming mode. See "Smart Auto Settings" on page 56
Turn off the Backlight of the remote control	Displays the tip to turn off remote control backlight. See "Turning remote control backlight on/off" on page 24 for more information.
System Update	Allows you to update the software on the projector via a USB flash drive. See "Upgrading your projector" on page 34 for more information.

Item	Options and descriptions
System Information	Displays hardware/software information for the projector including its device name, operating system version, memory, storage capacity and serial number.
Projector Information	Displays information on the current status of the projector including the Detected Resolution, Source, Picture Mode, Power Mode, Color System, Light Source Usage Time, Firmware Version, and Service Code.
Factory Reset	Returns the projector to its factory default state. Note This function resets your projector only. If you wish to reset your ATV dongle (QS02), perform factory reset from the Android settings menu.

Maintenance

Care of the projector

Your projector needs little maintenance. The only thing you have to do on a regular basis is keep the lens clean.

Never remove any parts of the projector. Contact your dealer or local customer service center if the projector fails to operate as expected.

Cleaning the lens

Clean the lens whenever you notice dirt or dust on the surface. Please be sure to turn off the projector and let it cool down completely before cleaning the lens.

- Use a canister of compressed air to remove dust.
- If there is dirt or smears, use lens-cleaning paper or moisten a soft cloth with lens cleaner and gently wipe the lens surface.
- Never use any type of abrasive pad, alkaline/acid cleaner, scouring powder, or volatile solvent, such as alcohol, benzene, thinner or insecticide. Using such materials or maintaining prolonged contact with rubber or vinyl materials may result in damage to the projector surface and cabinet material.

Note

Never use wax, alcohol, benzene, thinner or other chemical detergents. These can damage the case.

Storing the projector

If you need to store the projector for an extended time, please follow the instructions below:

- Make sure the temperature and humidity of the storage area are within the recommended range for the projector. Please refer to ["Specifications" on page 66](#) or consult your dealer about the range.
- Retract the adjustable feet/kickstand (if available).
- Remove the batteries from the remote control.
- Pack the projector in its original packing or equivalent.

Transporting the projector

It is recommended that you ship the projector with its original packing or equivalent.

Light source information

Go to **PROJECTOR MENU** > **System** > **Projector Information** and press OK. The **Projector Information** page appears.

Extending LED life

The LED headlight includes a bulb which features a light-source life far beyond traditional bulbs, yet it is still a consumable item. To keep the LED life as long as possible, you can change the following settings via the settings menu.

Go to **Power Mode** and select a suitable light source mode from among the provided modes.

Set the projector to **Eco** or **Low Power Consumption** mode to extend the LED life.

Light source mode	Description
Normal	100% LED brightness.
Eco	This setting reduces system noise and power consumption by 50%. If Eco mode is selected, the light output will be reduced and result in darker projected pictures.
Low Power Consumption	Lower its power consumption to 30% to extend the LED life.

Troubleshooting

 The LED indicator is flashing red.

Scenario	LED status
Driver board error	Flashing red/blue
Fan error	Flashing red/magenta
Optical engine temperature error	Flashing red
2D ToF error	Flashing red/green
G sensor error	Flashing red/cyan

Contact customer service for assistance.

Note

Refer to "[LED indicator](#)" on page 31 for power LED indicator.

 The projector does not turn on.

Cause	Remedy
There is no power from the power cord.	Plug the power cord into the AC power jack on the projector, and plug the power cord into the power outlet. If the power outlet has a switch, make sure that it is switched on.
Attempting to turn the projector on again during the cooling process.	Wait until the cooling down process has completed.

 No picture.

Cause	Remedy
The video source is not turned on or connected correctly.	<ul style="list-style-type: none">• Check if the video source is properly connected.• The projector may be in Audio-only, power saving or eye protection mode. Press the power key to disable.

Cause	Remedy
The projector is not correctly connected to the input signal device.	Check the connection.
The input signal has not been correctly selected.	Select the correct input signal with the  key.

Blurred image

Cause	Remedy
The projection lens is not correctly focused.	Adjust the focus of the lens. See "Fine-tuning the image clarity" on page 36 .
The projector and the screen are not aligned properly.	Adjust the projection angle and direction as well as the height of the projector if necessary.
The auto focus and auto 2D keystone functions did not work.	Try to move and lift up the projector a little bit.

Remote control does not work.

Cause	Remedy
The batteries are out of power.	Replace both of the batteries with new ones.
There is an obstacle between the remote control and the projector.	Remove the obstacle.
You are too far away from the projector.	Stand within 8 meters (26 feet) of the projector.

 Screen brightness adjustment.

Cause	Remedy
The screen is not as bright as expected.	The screen brightness is changed by the light source mode. Check the light source mode from Power Mode . Choose Normal to have the full light source brightness. Note that this option also consumes more power than other options.

Specifications

Projector specifications

Category	Item	Descriptions
Display	Brightness (ANSI lumens)	1000
	Native Resolution	1080P (1920x1080)
	Native Aspect Ratio	16:9
	Contrast Ratio (FOFO)	100,000:1
	Display Color	24-bit (16.7 million colors)
	Light Source	LED
	Light Source Life	ECO: 30000 hrs Normal: 20000 hrs
Optical	Throw Ratio	1.194
	Zoom Ratio	Fixed
	Lens	Fixed
	Projection Offset (Full-Height)	100%
	Keystone Adjustment	2D, (Auto) Vertical & Horizontal \pm 30 degrees (distance to the wall by projection direction: within 2M); 2D, (Manual) Vertical & Horizontal \pm 40 degrees
	Clear Image Size	60"~120"
	Corner Fit	Yes
Picture	Rec. 709 Coverage	97%
Compatibility	Input Lag	26.5ms (1080P 60Hz)
	Resolution Support	VGA (640 x 480) to 4K UHD (3840 x 2160)
	Horizontal Frequency	15K~135KHz
	Vertical Scan Rate	23~85Hz
	HDTV Compatibility	480i, 480p, 576i, 576p, 720p, 1080i, 1080p, 2160p
I/O Interface	HDMI in	(x2) HDMI-1 (2.0b/HDCP2.3) HDMI-Internal (2.0b/HDCP2.3)
	USB Type A	(x2) USB Type A-2 (2.0/Power Supply 0.5A/Internal/FW Upgrade) USB Type A-1 (2.0/Power Supply0.5A/Reader)
	USB Type C	(x1) Display Port/ PD in 20V-2.25A to 5A/ PD out 5V-1.5A, 9V-1.5A, 12V-1.5A, 15V1.2A
Audio	Speaker	(x2) 5W
	Audio out (3.5mm Mini Jack)	(x1)
	HDMI Audio Return	Yes, ARC, 2 channel
	Woofer	10W Chamber

Category	Item	Descriptions
Environment	Power Supply	AC 100 to 240 V, 50/60 Hz
	Typical Power Consumption	120W@100 ~ 240VAC
	Acoustic Noise (Typ./Eco./Low Power Consumption)(dB)	28dBA/26dBA/26dBA
	Operating Temperature	0~40°C
	Storage Temperature	-20~60°C
	Operating Relative Humidity	10~90%, without condensation
	Storage Relative Humidity	10~90%, without condensation
Smart	Bluetooth	Bluetooth 5.0
	Wi-Fi Standard	802.11a/b/g/n/ac/ax(2.4GHz/5GHz)
Dimension and Weight	Net Weight (kg)	2.9 Kg
	Net Weight (lb)	6.39 lb
	Dimensions (WxHxD) (mm)	169(W) x 193(H) x 213.5(D)mm
	Dimensions (WxHxD) (inch)	6.7(W) x 7.6(H) x 8.4(D)in
Projection System	Projection System	DLP
	DMD size	0.33" Pico

Note

- LED life results will vary depending on environmental conditions and usage.
- The performance of Wi-Fi and Bluetooth might be disturbed by distance and obstacles.

Timing chart

Resolution	Resolution	Vertical frequency (Hz)	Horizontal frequency (KHz)	Dot Clock Frequency (MHz)
640 x 480	VGA_60	59.940	31.469	25.175
	VGA_72	72.809	37.861	31.500
	VGA_75	75.000	37.500	31.500
	VGA_85	85.008	43.269	36.000
720 x 400	720x400_70	70.087	31.469	28.322
800 x 600	SVGA_60	60.317	37.879	40.000
	SVGA_72	72.188	48.077	50.000
	SVGA_75	75.000	46.875	49.500
	SVGA_85	85.061	53.674	56.250
1024 x 768	XGA_60	60.004	48.363	65.000
	XGA_70	70.069	56.476	75.000
	XGA_75	75.029	60.023	78.750
	XGA_85	84.997	68.667	94.500
1152 x 864	1152 x 864_75	75.000	67.500	108.000
1024x576	BenQ Notebook Timing	60.000	35.820	46.996
1024x600	BenQ Notebook Timing	64.995	41.467	51.419
1280x720	1280 x 720_60	60.000	45.000	74.250
1280 x 768	1280 x 768_60 (Reduce Blanking)	60.000	47.396	68.250
	1280 x 768_60	59.870	47.776	79.500
1280 x 800	WXGA_60	59.810	49.702	83.500
	WXGA_75	74.934	62.795	106.500
	WXGA_85	84.880	71.554	122.500
1280 x 1024	SXGA_60	60.020	63.981	108.000
	SXGA_75	75.025	79.976	135.000
	SXGA_85	85.024	91.146	157.500

Resolution	Resolution	Vertical frequency (Hz)	Horizontal frequency (KHz)	Dot Clock Frequency (MHz)
1280 x 960	1280 x 960_60	60.000	60.000	108.000
	1280 x 960_85	85.002	85.938	148.500
1360 x 768	1360 x 768_60	60.015	47.712	85.500
1440 x 900	WXGA+_60 (Reduce Blanking)	60.000	55.469	88.750
	WXGA+_60	59.887	55.935	106.500
1400X1050	SXGA+_60	59.978	65.317	121.750
1600x1200	UXGA	60.000	75.000	162.000
1680x1050	1680x1050_60 (Reduce Blanking)	59.883	64.674	119.000
	1680x1050_60	59.954	65.290	146.250
640x480 @67Hz	MAC13	66.667	35.000	30.240
832x624 @75Hz	MAC16	74.546	49.722	57.280
1024x768 @75Hz	MAC19	75.020	60.241	80.000
1152x870 @75Hz	MAC21	75.060	68.680	100.000
1920x1080 @60HZ	1920X1080_60	60.000	67.500	148.500
1920x1200 @60HZ	1920X1200_60 (Reduce Blanking)	59.950	74.038	154.000
1920X1080 (VESA)	1920X1080_60 (for Auditorium model)	59.963	67.158	173.000
2560x1600	2560X1600_60 (Reduce Blanking) For 4K2K model	59.972	98.713	268.500
2560x1600 (VESA)	2560X1600_60	59.987	99.458	348.500
3840x2160	3840X2160_30 (Reduce Blanking) For 4K2K model	29.970	65.660	257.404
3840x2160	3840x2160_60 (Reduce Blanking) For 4K2K model	59.940	133.187	522.092
3840x2160	3840x2160_30 For 4K2K model	30.000	67.500	297.000
3840x2160	3840x2160_60 For 4K2K model	60.000	135.000	594.000

Note

- USB-C port for alt mode supports up to 1920X1080@60Hz.
- Not all timings are available to the input source connected to the internal HDMI port. See [“Video timings” on page 70](#) for available timings.

Video timings

Resolution	Resolution	Vertical frequency (Hz)	Horizontal frequency (KHz)	Dot Clock Frequency (MHz)
480i	720(1440) x 480	15.730	59.940	27.000
480p*	720 x 480	31.470	59.940	27.000
576i	720(1440) x 576	15.630	50.000	27.000
576p	720 x 576	31.250	50.000	27.000
720/50p	1280 x 720	37.500	50.000	74.250
720/60p	1280 x 720	45.000	60.000	74.250
1080/24P	1920 x 1080	27.000	24.000	74.250
1080/25P	1920 x 1080	28.130	25.000	74.250
1080/30P	1920 x 1080	33.750	30.000	74.250
1080/50i	1920 x 1080	28.130	50.000	74.250
1080/60i	1920 x 1080	33.750	60.000	74.250
1080/50P	1920 x 1080	56.250	50.000	148.500
1080/60P	1920 x 1080	67.500	60.000	148.500
2160/24P*	3840 x 2160	54.000	24.000	297.000
2160/25P*	3840 x 2160	56.250	25.000	297.000
2160/30P*	3840 x 2160	67.500	30.000	297.000
2160/50P*	3840 x 2160	112.500	50.000	594.000
2160/60P*	3840 x 2160	135.000	60.000	594.000

Note

- USB-C port for alt mode can support up to 1920X1080@60Hz.
- The input source connected to the internal HDMI port supports timings with * mark only.

Supported file formats

The projector's media reader is powered by the supplied Android TV Dongle QS02. See QS02 user manual from [Support.BenQ.com](https://support.benq.com) for the supported file formats.

For details on the supported media formats, please visit: <https://developer.android.com/guide/topics/media/media-formats>

Appendix

Working with a tripod (purchased separately)

Use a tripod plate to mount the projector onto a tripod.

1. Install the tripod's quick release plate to the projector's tripod screw hole and tighten the plate's screw.



2. Install the projector onto the tripod.

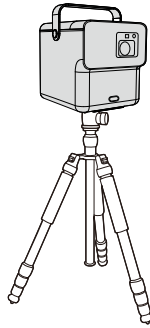





Note

The tripod screw hole on the bottom of your projector is not designed for ceiling mount installation. If you choose a ceiling location for your projector, refer to ["Front Ceiling" on page 25](#) and ["Rear Ceiling" on page 26](#) for instructions.

Pairing with a new remote control

Compatible BenQ remote control model: RCI077

In case you have received a new remote control from BenQ customer service, you need to pair it with your projector (with ATV dongle QS02 installed) before use.

1. Make sure the projector (with ATV dongle QS02 installed) is powered on and the batteries are installed to the remote control.
2. Keep the remote control close to your projector within 20 cm.
3. Press the  and  buttons together on the remote control to bring up the pairing screen.
4. Press and hold the  and  buttons together again for 10 seconds as instructed to start pairing. Follow the on-screen instructions to complete.

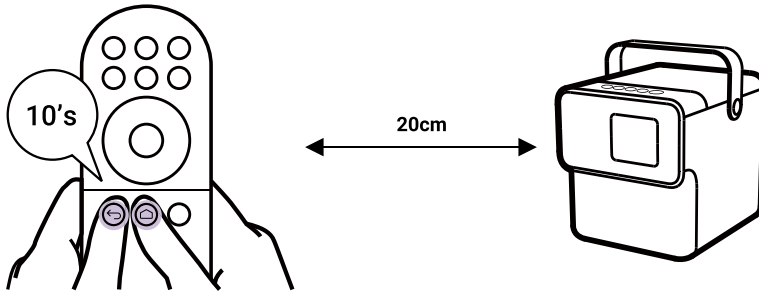

Copyright & disclaimer

Copyright

Copyright © 2024 by BenQ Corporation. All rights reserved. No part of this publication may be reproduced, transmitted, transcribed, stored in a retrieval system or translated into any language or computer language, in any form or by any means, electronic, mechanical, magnetic, optical, chemical, manual or otherwise, without the prior written permission of BenQ Corporation.

All other logos, products, or company names mentioned in this manual may be the registered trademarks or copyrights of their respective companies, and are used for informational purposes only.

Android™ is a trademark of Google LLC.

The Bluetooth® word mark and logos are registered trademarks owned by Bluetooth SIG, Inc. and any use of such marks by BenQ Corporation is under license.

iOS is a trademark or registered trademark of Cisco in the U.S. and other countries and is used under license.

macOS® is a trademark of Apple Inc., registered in the U.S. and other countries.

Disclaimer

BenQ Corporation makes no representations or warranties, either expressed or implied, with respect to the contents hereof and specifically disclaims any warranties, merchantability or fitness for any particular purpose. Further, BenQ Corporation reserves the right to revise this publication and to make changes from time to time in the contents hereof without obligation of BenQ Corporation to notify any person of such revision or changes. This user manual aims to provide the most updated and accurate information to customers, and thus all contents may be modified from time to time without prior notice. Please visit <http://support.benq.com> for the latest version of this manual.

It is the sole responsibility of the user if problems (such as data loss and system failure) occurred due to non-factory installed software, parts, and/or non-original accessories.

Warranty

BenQ warrants this product against any defects in material and workmanship, under normal usage and storage.

Proof of purchase date will be required with any warranty claim. In the event this product is found to be defective within the warranty period, BenQ's only obligation and your exclusive remedy shall be replacement of any defective parts (labor included). To obtain warranty service, immediately notify the dealer from which you purchased the product of any defects.

Important: The above warranty shall be void if the customer fails to operate the product in accordance with BenQ's written instructions, especially the ambient humidity must be in-between 10% and 90%, temperature in-between 0°C and 40°C, altitude lower than 2000 meters, and avoiding to operate the projector in a dusty environment. This warranty gives you specific legal rights, and you may have other rights which vary from country to country.

For other information, please visit www.BenQ.com.

Statement regarding hyperlinks and third-party websites

BenQ is not responsible for the content of the websites or of similar resources, which are maintained and controlled by third parties, that may be linked from this product. Providing links to those websites or to similar resources does not mean that BenQ makes any warranty or representation to their content by expression or by implication.

Any third party content or service preinstalled in this product is provided "as is". BenQ does not, by expression or by implication, make any warrant to the content or to the services provided by third parties. BenQ does not warrant or guarantee that the content or services provided by third parties are accurate, effective, most up-to-date, legal, or complete. Under no circumstances shall BenQ be liable for the content or services provided by third parties including their negligence.

Services provided by third parties may be terminated temporarily or permanently. BenQ does not warrant or guarantee that any content or services provided by third parties are in good condition at any time, and is

not liable for the termination of the said content and services. In addition, BenQ is not involved in any transactions you conduct in the websites or similar resources maintained by third parties. You should contact the content or service providers for any questions, concerns, or disputes.

BenQ ecoFACTS

BenQ has been dedicated to the design and development of greener product as part of its aspiration to realize the ideal of the "Bringing Enjoyment 'N Quality to Life" corporate vision with the ultimate goal to achieve a low-carbon society. Besides meeting international regulatory requirement and standards pertaining to environmental management, BenQ has spared no efforts in pushing our initiatives further to incorporate life cycle design in the aspects of material selection, manufacturing, packaging, transportation, using and disposal of the products. BenQ ecoFACTS label lists key eco-friendly design highlights of each product, hoping to ensure that consumers make informed green choices at purchase. Check out BenQ's CSR Website at <http://csr.BenQ.com/> for more details on BenQ's environmental commitments and achievements.



BenQ.com

© 2024 BenQ Corporation.
All rights reserved. Rights of modification reserved.