

USER MANUAL

ProLite

LCD Monitor

ENGLISH

ProLite XUB2495WSU
ProLite XU2495WSU

Thank you very much for choosing the iiyama LCD monitor.

We recommend that you take a few minutes to read this comprehensive manual carefully before installing and switching on the monitor. Please keep this manual in a safe place for your future reference.



Dear user, we congratulate you on the purchase of your iiyama LCD.

For details on warranty and locally used pixel policies that apply directly after installation of your product please check the iiyama website.

To report a fault, please contact your local support centre found at <https://iiyama.com>

Things to check before you call the iiyama information line

- | if the power cable is connected securely and turned on?
- | if the display has been turned on?
- | if the signal cable is connected securely and the correct input selected?
- | if the computer has been restarted with the display connected?
- | if the graphics card is correctly installed with the latest drivers possible?
- | if the correct native resolution has been selected via 'Display Properties'?
- | If the R/G/B signal configuration is correct?
- | if the displays On Screen Menu is shown?
- | if the correct brightness and contrast settings have been set?
- | if given display tolerances and compatibility have been considered?
- | if via the On Screen Menu you have performed a Factory Reset/Recall?

Before reporting the screen defect, please prepare the following information/evidence:

- | model number *
- | purchase receipt and serial number *
- | name and address for collection
- | telephone/fax number, for availability during the day
- | convenient collection date (date, time)
- | short description of the defect

Important Note:

If there is no fault found in the collected equipment after inspection, the transferring party shall incur charges for transport and administration.

If you have checked all of the above and there is still no picture, call our information line for assistance in your country.

Feedback on health and safety issues

If you have any health and safety concerns or questions about the product (including when using the product), please contact iiyama support through our website. You can also contact us by calling +31 204460404. After receiving your feedback, we will ask the responsible unit to handle it as soon as possible and a dedicated person will get back to you. Your feedback will also be recorded and incorporated into our evaluation for improvements

* see the identification plate on the back of the case.

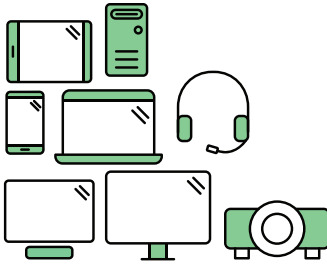

Say hello to a more sustainable product

IT products are associated with a wide range of sustainability risks throughout their life cycle. Human rights violations are common in the factories. Harmful substances are used both in products and their manufacture. Products can often have a short lifespan because of poor ergonomics, low quality and when they are not able to be repaired or upgraded.

This product is a better choice. It meets all the criteria in TCO Certified, the world's most comprehensive sustainability certification for IT products. Thank you for making a responsible product choice, that help drive progress towards a more sustainable future!

Criteria in TCO Certified have a life-cycle perspective and balance environmental and social responsibility. Conformity is verified by independent and approved verifiers that specialize in IT products, social responsibility or other sustainability issues. Verification is done both before and after the certificate is issued, covering the entire validity period. The process also includes ensuring that corrective actions are implemented in all cases of factory non-conformities. And last but not least, to make sure that the certification and independent verification is accurate, both TCO Certified and the verifiers are reviewed regularly.

Want to know more?

Read information about TCO Certified, full criteria documents, news and updates at [tcocertified.com](https://www.tcocertified.com). On the website you'll also find our Product Finder, which presents a complete, searchable listing of certified products.

CE MARKING DECLARATION OF CONFORMITY

This LCD monitor complies with the requirements of the EC/EU Directive 2014/30/EU "EMC Directive", 2014/35/EU "Low Voltage Directive", 2009/125/EC "ErP Directive" and 2011/65/EU "RoHS Directive".

The electro-magnetic susceptibility has been chosen at a level that gives correct operation in residential areas, business and light industrial premises and small-scale enterprises, inside as well as outside of the buildings. All places of operation are characterised by their connection to the public low voltage power supply system.

IYAMA CORPORATION: Wijkemeerstraat 8, 2131 HA Hoofddorp, The Netherlands

Model No. : PL2495W



We recommend recycling of used product. Please contact your dealer or iiyama service center. Recycle information is obtained via the Internet, using the address: <https://iiyama.com>

You can access the Web page of different countries from there.

- We reserve the right to change specifications without notice.
- All trademarks used in this user manual are the property of their respective owners.
- Eprel registration number XUB2495WSU-B7 : 1953794 XU2495WSU-B7 : 1953839

TABLE OF CONTENTS

FOR YOUR SAFETY.....	1
SAFETY PRECAUTIONS.....	1
SPECIAL NOTES ON LCD MONITORS.....	3
CUSTOMER SERVICE.....	3
CLEANING.....	3
BEFORE YOU OPERATE THE MONITOR.....	4
FEATURES.....	4
CHECKING THE CONTENTS OF THE PACKAGE.....	4
USING ARM OR STAND.....	5
FITTING AND REMOVAL OF STAND : ProLite XUB2495WSU.....	7
FITTING AND REMOVAL OF STAND : ProLite XU2495WSU.....	9
CONTROLS AND CONNECTORS : ProLite XUB2495WSU.....	10
CONTROLS AND CONNECTORS : ProLite XU2495WSU.....	11
CONNECTING YOUR MONITOR : ProLite XUB2495WSU.....	12
CONNECTING YOUR MONITOR : ProLite XU2495WSU.....	13
DISCONNECTING YOUR MONITOR.....	14
COMPUTER SETTING.....	14
ADJUSTING THE HEIGHT AND THE VIEWING ANGLER :	
ProLite XUB2495WSU.....	14
ADJUSTING THE VIEWING ANGLE : ProLite XU2495WSU.....	15
OPERATING THE MONITOR.....	16
ADJUSTMENT MENU CONTENTS.....	17
STANDBY FEATURE.....	26
TROUBLE SHOOTING.....	27
RECYCLING INFORMATION.....	28
APPENDIX.....	29
SPECIFICATIONS : ProLite XUB2495WSU-B7.....	29
SPECIFICATIONS : ProLite XU2495WSU-B7.....	30
DIMENSIONS : ProLite XUB2495WSU.....	31
DIMENSIONS : ProLite XU2495WSU.....	31
COMPLIANT TIMING.....	32

FOR YOUR SAFETY

SAFETY PRECAUTIONS

WARNING

STOP OPERATING THE MONITOR WHEN YOU SENSE TROUBLE

If you notice any abnormal phenomena such as smoke, strange sounds or fumes, unplug the monitor and contact your dealer or iiyama service center immediately. Further use may be dangerous and can cause fire or electric shock.

NEVER REMOVE THE CABINET

High voltage circuits are inside the monitor. Removing the cabinet may expose you to the danger of fire or electric shock.

DO NOT PUT ANY OBJECT INTO THE MONITOR

Do not put any solid objects or liquids such as water into the monitor. In case of an accident, unplug your monitor immediately and contact your dealer or iiyama service center. Using the monitor with any object inside may cause fire, electric shock or damage.

INSTALL THE MONITOR ON A FLAT, STABLE SURFACE

The monitor may cause an injury if it falls or is dropped.

DO NOT USE THE MONITOR NEAR WATER

Do not use where water may be splashed or spilt onto the monitor as it may cause fire or electric shock.

OPERATE UNDER THE SPECIFIED POWER SUPPLY

Be sure to operate the monitor only with the specified power supply. Use of an incorrect voltage will cause malfunction and may cause fire or electric shock.

PROTECT THE CABLES

Do not pull or bend the power cable and signal cable. Do not place the monitor or any other heavy objects on the cables. If damaged, the cables may cause fire or electric shock.

ADVERSE WEATHER CONDITIONS

It is advisable not to operate the monitor during a heavy thunder storm as the continual breaks in power may cause malfunction. It is also advised not to touch the plug in these circumstances as it may cause electric shock.

CAUTION

INSTALLATION LOCATION

Do not install the monitor where sudden temperature changes may occur, or in humid, dusty or smoky areas as it may cause fire, electric shock or damage. You should also avoid areas where the sun shines directly on the monitor.

DO NOT PLACE THE MONITOR IN A HAZARDOUS POSITION

The monitor may topple and cause injury if not suitably located. Please also ensure that you do not place any heavy objects on the monitor, and that all cables are routed such that children may not pull the cables and possibly cause injury.

MAINTAIN GOOD VENTILATION

Ventilation slots are provided to keep the monitor from overheating. Covering the slots may cause fire. To allow adequate air circulation, place the monitor at least 10cm (or 4 inches) from any walls. When removing the tilt stand, the ventilation slots on the back side of the monitor can be blocked. This may overheat the monitor and may cause fire or damage. Make sure to allow enough ventilation when removing the tilt stand. Operating the monitor on its back, side, upside down or on a carpet or any other soft material may also cause damage.

DISCONNECT THE CABLES WHEN YOU MOVE THE MONITOR

When you move the monitor, turn off the power switch, unplug the monitor and be sure the signal cable is disconnected. If you do not disconnect them, it may cause fire or electric shock.

UNPLUG THE MONITOR

If the monitor is not in use for a long period of time it is recommended that it is left unplugged to avoid accidents.

HOLD THE PLUG WHEN DISCONNECTING

To disconnect the power cable or signal cable, always pull it by the plug. Never pull on the cable itself as this may cause fire or electric shock.

DO NOT TOUCH THE PLUG WITH WET HANDS

Pulling or inserting the plug with wet hands may cause electric shock.

WHEN YOU INSTALL THE MONITOR ON YOUR COMPUTER

Be sure the computer is strong enough to hold the weight of the monitor, otherwise, you may damage your computer.

CAREFUL! PROTECT YOUR HANDS AND FINGERS

- Be careful not to hurt your fingers or hands when you change the height or the angle.
- Injury can occur if care is not taken to avoid finger contact with the displays base when adjusting the height. (Just for height adjustable model.)

REMARK FOR 24/7 USAGE

This product is not specifically designed for 24/7 usage in all environments.

REMARK SPECIFIC TO DESKTOP USE

This product is designed for desktop use, not for digital signage (electronic signboard) applications such as ceiling hanging or wall mounting.

OTHERS

ERGONOMIC RECOMMENDATIONS

To eliminate eye fatigue, do not operate the monitor against a bright background or in a dark room. For optimal viewing comfort, the monitor should be just below eye level and 40-60 cm (16-24 inches) away from your eyes. When using the monitor over a prolonged time, a ten minute break every hour is recommended as looking at the screen continuously can cause eye strain.

SPECIAL NOTES ON LCD MONITORS

The following symptoms are normal with LCD monitors and do not indicate a problem.

NOTE

- When you first turn on the LCD monitor, the picture may not fit in the display area because of the type of computer that is used. In this case, adjust the picture position to the correct position.
- You may find slightly uneven brightness on the screen depending on the desktop pattern you use.
- Due to the nature of the LCD screen, an afterimage of the previous screen may remain after switching the image, when the same image is displayed for hours. In this case, the screen can be recovered slowly by changing the image or turning off the Power Switch for some hours.

CUSTOMER SERVICE

NOTE

- If you have to return your unit for service and the original packaging has been discarded, please contact your dealer or iiyama service center for advice or replacement packaging.

CLEANING

WARNING

- If you drop any materials or liquids such as water into the monitor when cleaning, unplug the power cable immediately and contact your dealer or iiyama service center.

CAUTION

- For safety reasons, turn off the power switch and unplug the monitor before you clean it.

NOTE

- To protect the LCD panel, do not scratch or rub the screen with a hard object.
- Never use any of the following strong solvents. These will damage the cabinet and the LCD screen.

Thinner	Spray-type cleaner
Benzine	Wax
Abrasive cleaner	Acid or Alkaline solvent

- Touching the cabinet with any product made from rubber or plastic for a long time may cause degeneration or loss of paint on the cabinet.

CABINET

Stains can be removed with a cloth lightly moistened with a mild detergent solvent. Then wipe the cabinet with a soft dry cloth.

LCD SCREEN

Periodic cleaning with a soft dry cloth is recommended.

Don't use tissue paper etc. because these will damage the LCD screen.

BEFORE YOU OPERATE THE MONITOR

FEATURES

- ◆ Supports Resolutions up to 1920 × 1200
- ◆ High Contrast 1000:1 (Typical), Adv. Contrast Function Available / Brightness 300cd/m² (Typical)
- ◆ Quick Response Time 4ms (Gray to Gray) with OverDrive
- ◆ Blue Light Reducer
- ◆ Flicker Free
- ◆ Digital Character Smoothing
- ◆ 2 × 2W Stereo Speakers
- ◆ Standby Feature
- ◆ VESA Mounting Standard (100mm×100mm) Compliant
- ◆ Keyhole for Security Lock

ENGLISH

CHECKING THE CONTENTS OF THE PACKAGE

The following accessories are included in your package. Check to see if they are enclosed with the monitor. If anything is missing or damaged, please contact your local iiyama dealer or regional iiyama office.

- | | | |
|-----------------------------|-----------------------------|-----------------------------------------|
| ■ Power Cable* ¹ | ■ HDMI Cable | ■ USB Cable |
| ■ VESA Plate* ² | ■ Stand-Neck | ■ Stand-Base with a screw* ² |
| ■ Stand-Base* ³ | ■ Screwdriver* ² | ■ Cable Holder* ³ |
| ■ Safety Guide | ■ Quick Start Guide | |

CAUTION

*¹ All guarantees and warranties are void for any problems or damage caused by a power cable not supplied by iiyama.

An approved power cable greater or equal to H05VVF, 3G, 0.75mm² must be used.

*² Accessory for ProLite XUB2495WSU

*³ Accessory for ProLite XU2495WSU

USING ARM OR STAND

CAUTION

- This product is designed for desktop use, not for digital signage (electronic signboard) applications such as ceiling hanging or wall mounting.
- Before installation, make sure the display arm or desk arm stand is strong enough to hold the necessary weight of the monitor and the mount.
- Panel angle adjustment range : 23° upward and 5° downward
- This product cannot be used with the monitor screen facing downward/upward.

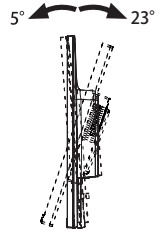

[DISPLAY ARM OR DESK ARM STAND]

CAUTION

- When you use with the display arm or desk arm stand, in consideration of thickness of the mounting stage, tighten the M4 Screws (4pcs) which "L" length is 10mm to fasten the monitor. Using the screw longer than this may cause electric shock or damage because it may contact with the electrical parts inside the monitor.

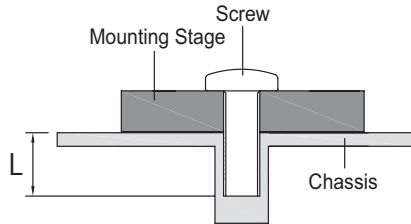

[ROTATING THE MONITOR]

• ProLite XUB2495WSU

The monitor is designed to be compatible with both landscape and portrait modes. Video card for portrait display will be required for rotating the image on the screen.

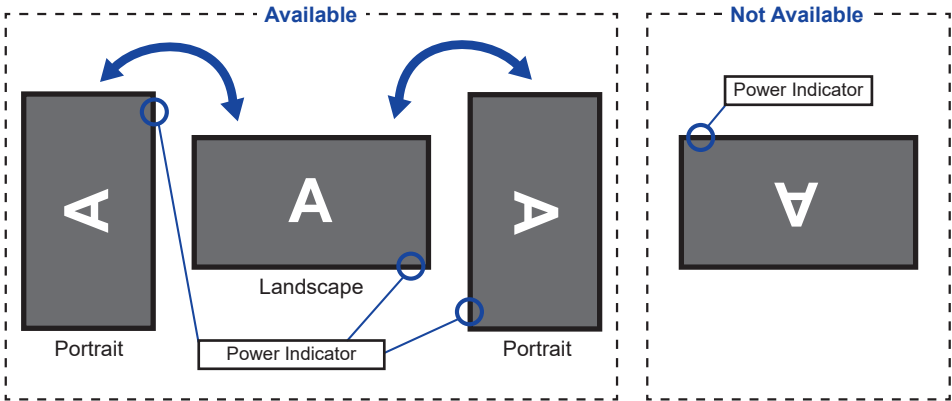

With Stand:

NOTE

- Adjust the monitor's height before panel rotation.
- Attempting to rotate the panel forcibly without adjusting the stand height may cause damage to the panel or the stand.

• ProLite XU2495WSU

The monitor is designed to be compatible only with the landscape mode.

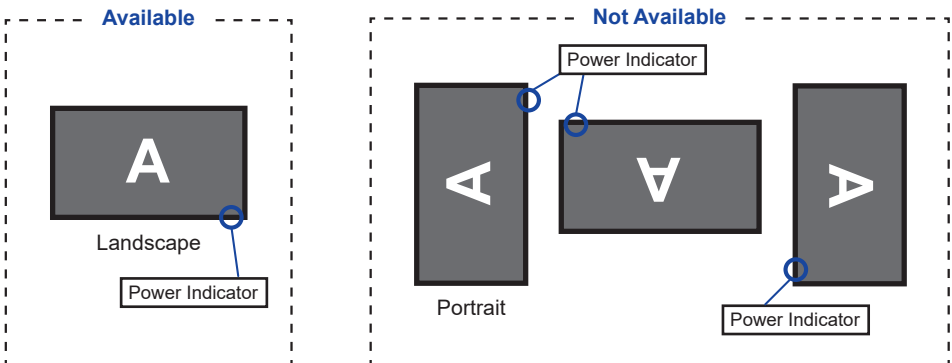

FITTING AND REMOVAL OF STAND : ProLite XUB2495WSU

CAUTION

- Put the monitor on a stable surface. The monitor may cause injury or damage if it falls or is dropped.
- Do not give a strong impact to the monitor. It may cause damage.
- Unplug the monitor before removal or installation to avoid an electric shock or a damage.

<Installation>

- ① Attach the Stand-Neck to the VESA Plate and then tighten the 'thumb screw' with the provided screwdriver to secure them.

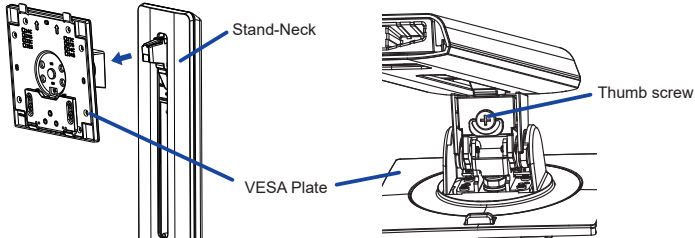

- ② Install the Stand-Base to the Stand-Neck and then tighten the 'thumb screw' with the provided screwdriver to secure them.

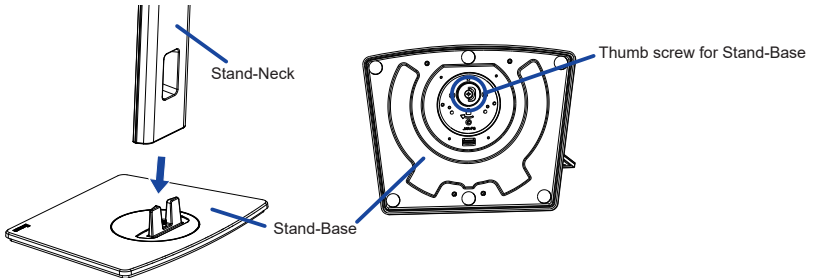

- ③ Put a piece of soft cloth on the table beforehand to prevent the monitor from being scratched. Lay the monitor flat on a table with front face down.
- ④ Hold the monitor and install the assembled stand to the monitor until it clicks to secure.

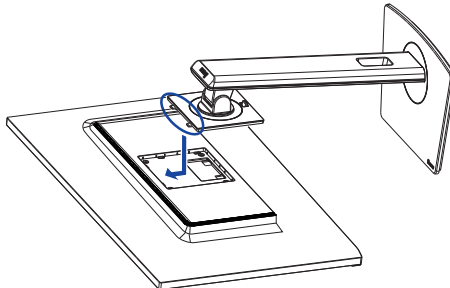

<Removal>

- ① Put a piece of soft cloth on the table beforehand to prevent the monitor from being scratched.
Lay the monitor flat on a table with front face down.
- ② Press the release button to remove the stand.

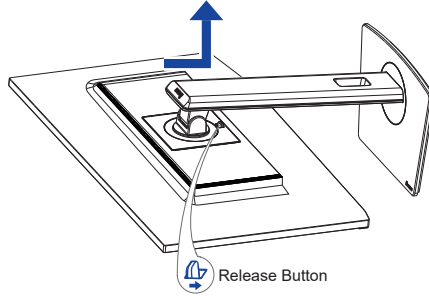

- ③ Loosen the 'thumb screw' with the provided screwdriver to remove the Stand-Neck from the VESA Plate.
- ④ Loosen the 'thumb screw' with the provided screwdriver to remove the Stand-Base from the Stand-Neck.

FITTING AND REMOVAL OF STAND : ProLite XU2495WSU

CAUTION

- Put the monitor on a stable surface. The monitor may cause injury or damage if it falls or is dropped.
- Do not give a strong impact to the monitor. It may cause damage.
- Unplug the monitor before removal or installation to avoid an electric shock or a damage.

<Installation>

- ① Put a piece of soft cloth on the table beforehand to prevent the monitor from being scratched. Lay the monitor flat on a table with front face down.
- ② Hold the monitor and install the Stand-Neck to the monitor until it clicks to secure.
- ③ Install the Stand-Base to the Stand-Neck.
- ④ Place the Cable Holder.

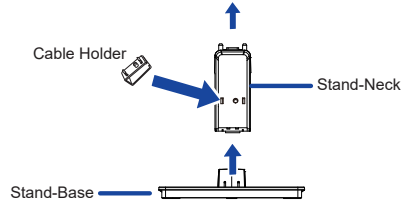
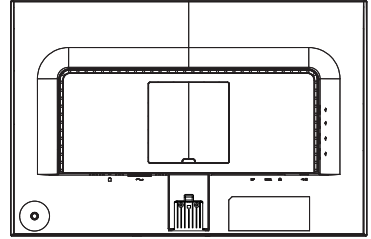

<Removal>

- ① Put a piece of soft cloth on the table beforehand to prevent the monitor from being scratched. Lay the monitor flat on a table with front face down.
- ② Keep pressing the Hooks inward to pull out the Stand-Base.

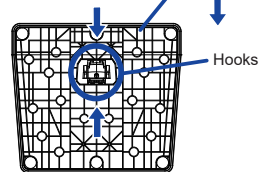
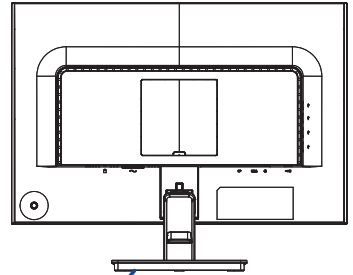

- ③ Press the Hook on the back of the monitor and remove the Stand-Neck from the monitor.

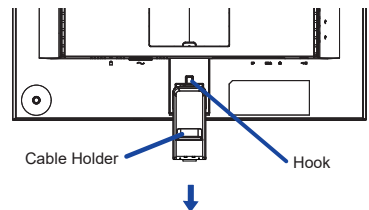

- ④ Pull and hold the cable holder toward you, slide it to the left and remove it.

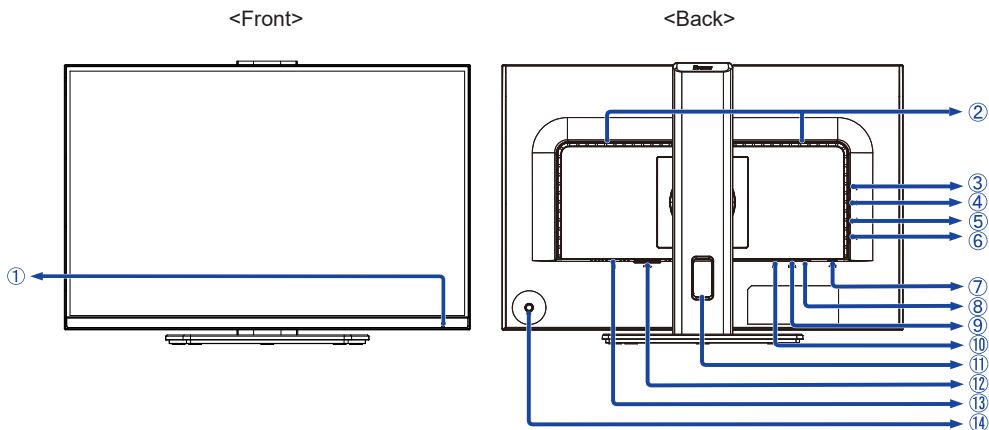

- ① Power Indicator

NOTE Blue: Normal operation
Orange: Standby mode

- ② Speakers

- ③ USB Type-C Downstream Connector (USB3.2 Gen 1: 5Gbps, 5V, 3A)

- ④⑤⑥ USB Type-A Downstream Connector (USB3.2 Gen 1: 5Gbps, 5V, 900mA)

- ⑦ USB Upstream Connector ()

- ⑧ Headphone connector ()

- ⑨ HDMI Connector (HDMI)

- ⑩ DisplayPort Connector (DP)

- ⑪ Cable Hole

- ⑫ AC Connector(~ : Alternating current) (~)

- ⑬ Keyhole for Security Lock

NOTE You can fasten a security lock and cable to prevent the monitor from being removed without your permission.

- ⑭ Joystick / Power Button

- [Center] Power / Menu

NOTE A short press turns ON the monitor.

A long press for 6 seconds turns OFF the monitor.

- [↑] Up / Input Select **Direct**

- [↓] Down

- [→] Right / Volume * **Direct**

- [←] Left / Submenu * **Shortcut**

* Direction when viewing the screen from the front

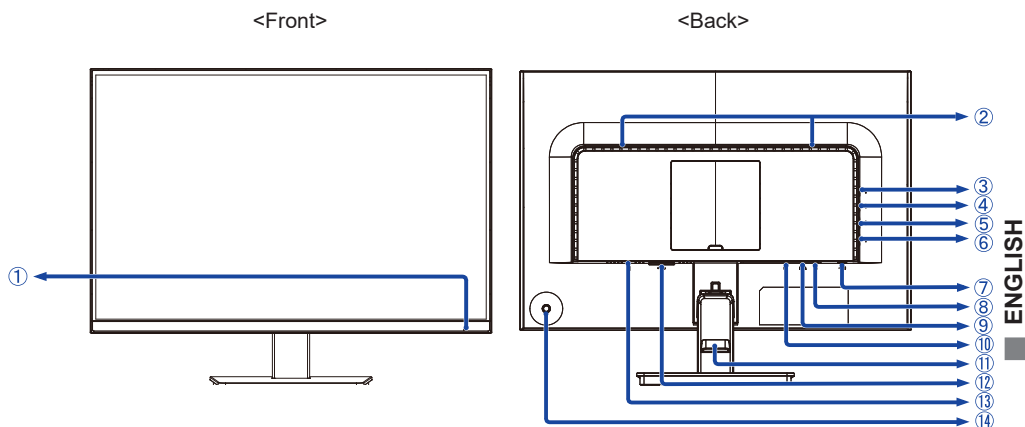

① Power Indicator

NOTE Blue: Normal operation
Orange: Standby mode

② Speakers

③ USB Type-C Downstream Connector (USB3.2 Gen 1: 5Gbps, 5V, 3A)

④⑤⑥ USB Type-A Downstream Connector (USB3.2 Gen 1: 5Gbps, 5V, 900mA)

⑦ USB Upstream Connector ()

⑧ Headphone connector ()

⑨ HDMI Connector (HDMI)

⑩ DisplayPort Connector (DP)

⑪ Cable Holder

⑫ AC Connector(~ : Alternating current) (~)

⑬ Keyhole for Security Lock

NOTE You can fasten a security lock and cable to prevent the monitor from being removed without your permission.

⑭ Joystick / Power Button

- [Center] Power / Menu

NOTE A short press turns ON the monitor.
A long press for 6 seconds turns OFF the monitor.

- [Up] Up / Input Select **Direct**
- [Down] Down
- [Right] Right / Volume * **Direct**
- [Left] Left / Submenu * **Shortcut**

* Direction when viewing the screen from the front

CONNECTING YOUR MONITOR : ProLite XUB2495WSU

- ① Ensure that both the computer and the monitor are switched off.
- ② Connect the computer to the monitor with the signal cable.
- ③ Connect the computer to the monitor with the USB Cable.
- ④ Connect the Power Cable to the monitor first and then to the power source.
- ⑤ Turn on your monitor and computer.

NOTE

- Make sure that the building installation has a circuit breaker of 120/240V, 20A (maximum).
- The signal cables used for connecting the computer and monitor may vary with the type of computer used. An incorrect connection may cause serious damage to both the monitor and the computer. The cable supplied with the monitor is for a standard connector. If a special cable is required please contact your local iiyama dealer or regional iiyama office.
- The Class I pluggable equipment Type A must be connected to protective earth.
- The socket-outlet shall be installed near the equipment and shall be easily accessible.
- Excessive sound pressure from ear-/headphones can cause hearing damage/hearing loss.

[Example of Connection]

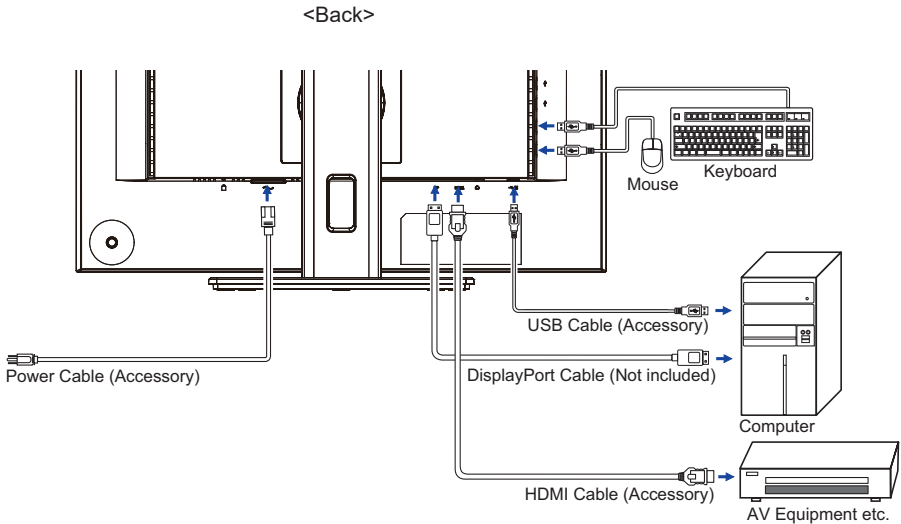

[Collect Cables]

Put the cables through the cable hole to bundle them.

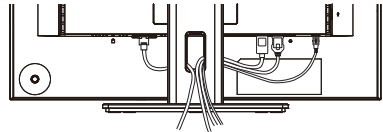

CONNECTING YOUR MONITOR : ProLite XU2495WSU

- ① Ensure that both the computer and the monitor are switched off.
- ② Connect the computer to the monitor with the signal cable.
- ③ Connect the computer to the monitor with the USB Cable.
- ④ Connect the Power Cable to the monitor first and then to the power source.
- ⑤ Turn on your monitor and computer.

NOTE

- Make sure that the building installation has a circuit breaker of 120/240V, 20A (maximum).
- The signal cables used for connecting the computer and monitor may vary with the type of computer used. An incorrect connection may cause serious damage to both the monitor and the computer. The cable supplied with the monitor is for a standard connector. If a special cable is required please contact your local iiyama dealer or regional iiyama office.
- The Class I pluggable equipment Type A must be connected to protective earth.
- The socket-outlet shall be installed near the equipment and shall be easily accessible.
- Excessive sound pressure from ear-/headphones can cause hearing damage/hearing loss.

[Example of Connection]

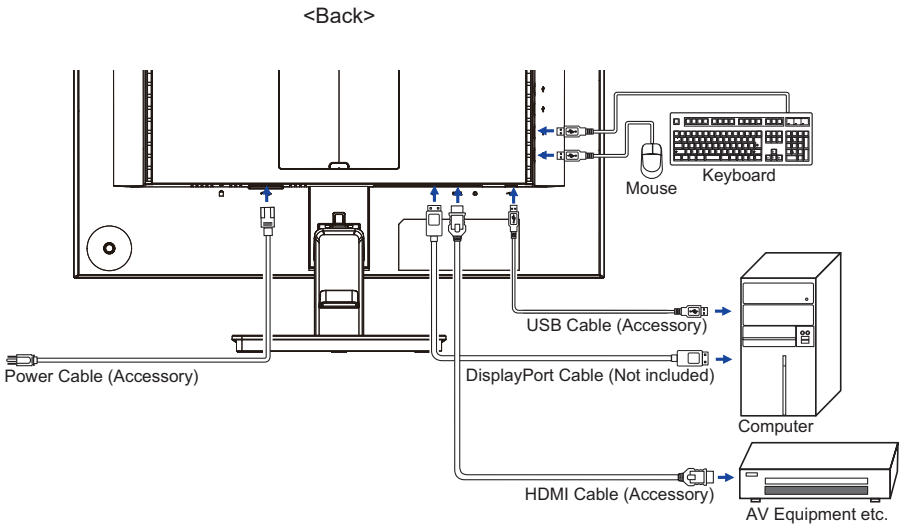

[Collect Cables]

Put the cables through the Cable Holder to bundle them.

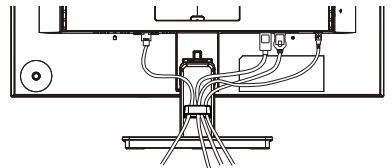

DISCONNECTING YOUR MONITOR

- ① Ensure that both the computer and the monitor are switched off.
- ② Disconnect the power source first and then the Power Cable from the monitor.
- ③ Disconnect the USB cable from the computer and the monitor.
- ④ Disconnect the signal cable from the computer and the monitor.

COMPUTER SETTING

- Signal Timing
Change to the desired signal timing listed on page 32: COMPLIANT TIMING.

ADJUSTING THE HEIGHT AND THE VIEWING ANGLER : ProLite XUB2495WSU

- For optimal viewing it is recommended to position yourself directly opposite to the full face of the monitor, then adjust the monitor's height and angle to your own preference.
- Hold the panel so that the monitor does not topple when you change the monitor's height or angle.
- You are able to adjust the monitor's height up to 150mm, angle up to 45° right and left, 23° upward and 5° downward.

NOTE ■ Do not touch the LCD screen when you change the height or the angle. It may cause damage or break the LCD screen.

- Careful attention is required not to pinch your fingers or hands into the moving part of the stand when you change the angle.

- Injury can occur if care is not taken to avoid finger contact with the displays base when adjusting the height.

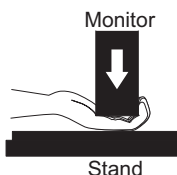
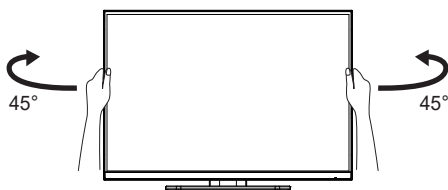
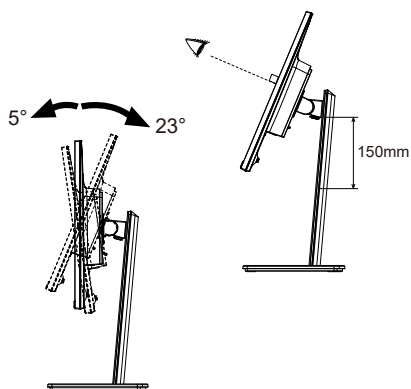

ADJUSTING THE VIEWING ANGLE : ProLite XU2495WSU

- For optimal viewing it is recommended to look at the full face of the monitor.
- Hold the stand so that the monitor does not topple when you change the monitor's angle.
- You are able to adjust the monitor's angle up to 20° upward, 4° downward.
- In order to ensure a healthy and relaxed body position when using the monitor at visual display workstations, it is recommended that the adjusted tilt angle should not exceed 10°. Adjust the monitor's angle to your own preference.

NOTE

- Do not touch the LCD screen when you change the angle. It may cause damage or break the LCD screen.
- Careful attention is required not to catch your fingers or hands when you change the angle.

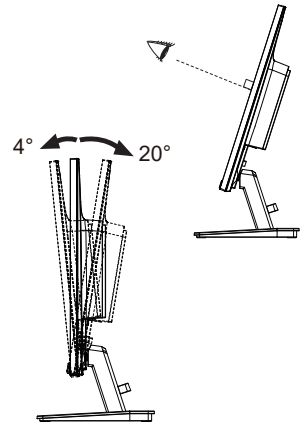

OPERATING THE MONITOR

To create the best picture, your iiyama LCD monitor has been preset at the factory with the COMPLIANT TIMING shown on page 32. You are also able to adjust the picture by following the button operation shown below.

- ① Press the Joystick to start the On Screen Display (OSD) feature. There are additional Menu items which can be switched by tilting the Joystick ◀ / ▶.



- ② Select the Menu page which contains the adjustment icon relating to the adjustment you want to make. Press the Joystick. Then, tilting the Joystick ▲ / ▼ to highlight the desired adjustment icon.
- ③ Press the Joystick again. Tilting the Joystick ◀ / ▶ to make the appropriate adjustment or setting.
- ④ Press the Joystick and then tilt it ◀ to leave the menu, and the settings you just made would be automatically saved.

For example, to correct for OSD vertical position, select "OSD" of Menu item and then press the Joystick. Then, select "OSD Vertical Position" by tilting the Joystick ▲ / ▼ .

An adjustment scale becomes active after you press the Joystick. Then, tilt the Joystick ◀ / ▶ to change the OSD vertical position settings. The OSD vertical position of the overall display should be changing accordingly while you are doing this.

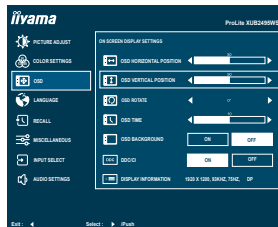





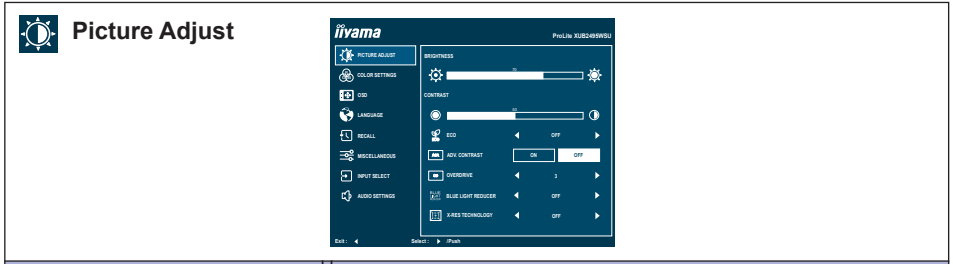

Press the Joystick and finally tilt it ◀ to close the OSD feature. All changes are saved in the memory.

NOTE

- When button operations are aborted during adjustment, On Screen Display disappears when the time set for the OSD Time has passed. Also, tilting the Joystick ◀ can be used to return previous menu and turn off the On Screen Display.
- Any changes are automatically saved in the memory when the On Screen Display disappears. Turning off the power should be avoided while using the Menu.
- All adjustments have only one setting which applies to all signal timings.

ADJUSTMENT MENU CONTENTS



Adjustment Item	Problem / Option		Button to Press
Brightness *1,2	Too dark Too bright		 
Contrast *1	Too dull Too intense		 
Eco *1 Shortcut	Off	Normal	
	Mode1	Brightness of back-light is reduced.	
	Mode2	Brightness of back-light is reduced more than Mode1.	
	Mode3	Brightness of back-light is reduced more than Mode2.	
Adv. Contrast *1	On	Increased Contrast Ratio	
	Off	Typical Contrast Ratio	
Overdrive	Off / 1 / 2 / 3 / 4 / 5 It will improve the gray level response time of the LCD panel. A higher level results in a faster response time.		 
Blue Light Reducer *1 Shortcut	Off	Typical	
	Mode 1	Blue light is reduced.	
	Mode 2	Blue light is reduced more than Mode 1.	
	Mode 3	Blue light is reduced more than Mode 2.	
X-Res Technology	Off	Normal	
	Soft	Enhance the picture edge.	
	Middle	Enhance the picture edge more than the Soft option.	
	Hard	Enhance the picture edge more than the Middle option.	

*1 The availability of each item depends on which item is activated. See page 25 Function Correlation Matrix for more details.

*2 Adjust the Brightness when you are using the monitor in a dark room and feel the screen is too bright.

Shortcut







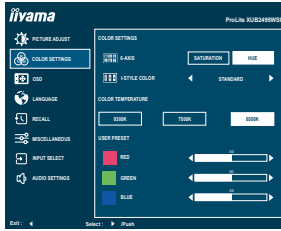

You can take a shortcut to the specific menu by the following operations.

- Eco: Tilting the Joystick ◀ with no Menu displayed and select "Eco".
- Blue Light Reducer: Tilting the Joystick ◀ with no Menu displayed and select "Blue Light Reducer".



Color Settings *1



Adjustment Item	Problem / Option		Button to Press
6-AXIS *2	Saturation	Red	You can set the Colours.   
		Yellow	
Green			
Cyan			
Blue			
Magenta			
Hue		Red	You can set the Colours.   
		Yellow	
		Green	
		Cyan	
		Blue	
		Magenta	
i-Style Color *3,4	Off	Return to a state set by color adjustment except i-Style Color.	
	Standard	For general windows environment and monitor default setting	
	Game	For PC game environment	
	Cinema	For movie and video environment	
	Scenery	For scenery environment	
	Text	For text editing and viewing in a word processing environment	
Color Temperature *2,3	9300K	Cool color	
	7500K	Normal color	
	6500K	Warm color	
	User Preset	Red	Too weak
Green			
Blue		Too strong	 

*1 Disabled when "Blue Light Reducer" is activated.

*2 Disabled when "i-Style Color" is activated.

*3 Disabled when "Adv. Contrast" is activated.

*4 The availability of each item depends on which item is activated. See page 25 Function Correlation Matrix for more details.









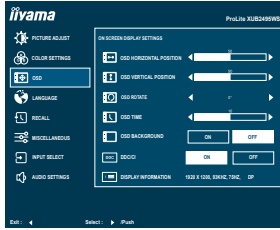







Shortcut

You can take a shortcut to the specific menu by the following operations.

- i-Style Color: Tilting the Joystick  with no Menu displayed and select "i-Style Color".

 **OSD**



Adjustment Item	Problem / Option		Button to Press
OSD Horizontal Position	OSD is too left OSD is too right		   
OSD Vertical Position	OSD is too low OSD is too high		   
OSD Rotate *	Rotates the OSD. 0° (Normal) / +90° (Rotate right) / -90° (Rotate left)		   
OSD Time	You can set the OSD display duration time between 5 and 60 seconds.		   
OSD Background	On	The background of OSD is made transparent.	
	Off	Return the background of OSD.	
DDC/CI	On	DDC/CI is On.	
	Off	DDC/CI is Off.	
Display Information	Displays information regarding the current input signal coming from the graphic card in your computer. <div style="border: 1px solid black; padding: 2px; display: inline-block;"> NOTE See your graphic card user guide for more information about changing the resolution and refresh. </div>		

* For **ProLite XUB2495WSU**



Language

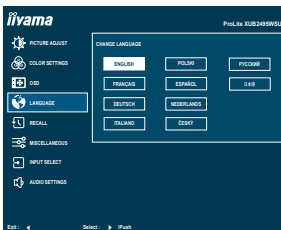

Adjustment Item	Problem / Option				Button to Press
Language	English	English	Español	Spanish	
	Français	French	Nederlands	Dutch	
	Deutsch	German	Česky	Czech	
	Italiano	Italian	Русский	Russian	
	Polski	Polish	日本語	Japanese	

ENGLISH



Recall

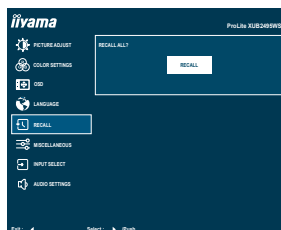

Adjustment Item	Problem / Option
Recall	Factory-preset data is restored.



Miscellaneous

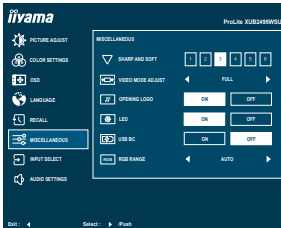

Adjustment Item	Problem / Option	
Sharp and Soft	1 2 3 4 5 6 You can change the picture quality from 1 to 6 (sharp to soft). Tilt the Joystick ◀ to change the picture quality in numerical order. Tilt the Joystick ▶ to change the picture quality in reverse numerical order. 	
Video Mode Adjust *	Full	Expansion display
	Aspect	Expansion display of Aspect
Opening Logo	On	Opening Logo is On.
	Off	Opening Logo is Off.
LED	On	The Power Indicator is turned On.
	Off	The Power Indicator is turned Off.
NOTE Turn Off the Power Indicator when you are bothered by the light.		
USB BC	On	USB devices can be charged even when the monitor is in the standby mode.
	Off	USB devices can not be charged when the monitor is in the standby mode.
NOTE When the monitor is turned off, USB devices cannot be charged even when the USB BC function is on. While this function is off, USB devices do not operate even when the monitor is in standby mode to save standby electricity. When operating USB devices, turn this function on.		
RGB Range	Auto	Automatically select Limited or Full.
	Full	For full-range color scale signalscale signal
	Limited	For limited color scale signal

* It can display in the center of the screen with a 4:3, 5:4 or 16:10 aspect ratio when input video resolution is 4:3, 5:4 or 16:10.

Input Select

Direct

Adjustment Item	Problem / Option		
Input Source	Auto	Searches for an available input source and selects automatically.	
	Manual	HDMI	Selects the Digital (HDMI) input.
		DisplayPort(DP)	Selects the Digital (DisplayPort) input.



NOTE “Auto” function enables automatic selection of the input sources available. The input source from the computer in standby mode can not be selected. If you manually select one of the input sources, the other source is not automatically selected.

Direct

You can skip the Menu items and directly display an option setting screen by using the following operations.

- Input Select: Tilting the Joystick ▲ with no Menu displayed, it shows following Menu.



Adjustment Item		Problem / Option		Button to Press
Volume	Direct	Too soft Too loud		 
Mute Audio	Direct	On	Turn off the sound temporarily.	
		Off	Return the sound volume to the previous level.	

Direct

You can skip the Menu items and directly display an option setting screen by using the following operations.

- Volume : Tilting the Joystick ► with no Menu displayed.
- Mute Audio : Tilting the Joystick ► for 3 seconds with no Menu displayed.

■ Lock Mode

<OSD Menu>

The OSD can be locked to avoid an accidental setting change.

1. Make sure the monitor is turned ON.
2. The OSD lock will be activated by tilting the Joystick [▼] for about 10 seconds. If you try to access the OSD by the Joystick, a message "OSD Locked" will appear on the screen.
3. The OSD lock will be deactivated by tilting the Joystick [▼] again for about 10 seconds.

<Power Button Function>

The Power Button function can be locked to avoid an accidental power operation.

1. Make sure the monitor is turned ON.
2. The Power Button function will be locked by tilting the Joystick [▲] for about 10 seconds. If you try to turn off the monitor by pressing the Joystick, a message "Power Button Locked" will appear on the screen.
3. The Power Button function will be unlocked by tilting the Joystick [▲] again for about 10 seconds.

■ Function Correlation Matrix

Item to be selected Item activated	Picture Adjust					Image Settings
	Contrast	Brightness	i-Style Color	Adv. Contrast	Eco	Blue Light Reducer
i-Style Color	—	—	—	—	—	—
Adv. Contrast	—	—	—	—	—	—
Eco	✓	—	—	—	—	—
Blue Light Reducer	✓	✓	—	—	—	—

✓ : Available

— : Not available

STANDBY FEATURE

This product features the standby function. When activated, it automatically reduces unnecessary power consumption of the monitor when your computer is not in use.

There is a standby step the monitor takes as described below. The standby function, including any timer settings is configured by the operating system. Check your operating system manual for information on how this can be configured.

■ Standby Mode

When the video signal from the computer is off, the monitor enters into Standby Mode which reduces the power consumption to less than 0.5W*. The screen becomes dark, and the power indicator turns to orange. From Standby Mode, the image reappears in several seconds when either the keyboard or the mouse are touched again.

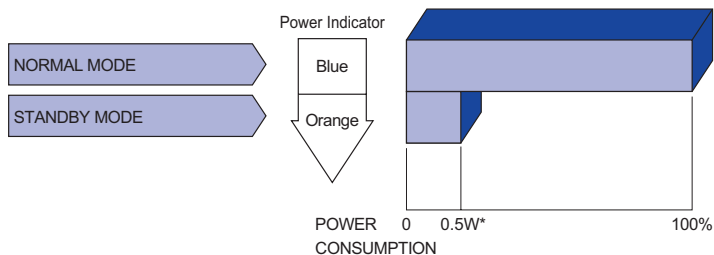

* When the USB devices are not connected.

TROUBLE SHOOTING

If the monitor fails to operate correctly, please follow the steps below for a possible solution.

1. Perform the adjustments described in OPERATING THE MONITOR, depending on the problem you have. If the monitor does not get a picture, skip to 2.
2. Consult the following items if you cannot find an appropriate adjustment item in OPERATING THE MONITOR or if the problem persists.
3. If you are experiencing a problem which is not described below or you cannot correct the problem, discontinue using the monitor and contact your dealer or iiyama service center for further assistance.

Problem	Check
① The picture does not appear.	
(Power indicator does not light up.)	<input type="checkbox"/> The Power Cable is firmly seated in the socket. <input type="checkbox"/> The Power Switch is turned ON. <input type="checkbox"/> The AC socket is live. Please check with another piece of equipment.
(Power indicator is blue.)	<input type="checkbox"/> If the blank screen saver is in active mode, touch the keyboard or the mouse. <input type="checkbox"/> Increase the Contrast and/or Brightness. <input type="checkbox"/> The computer is ON. <input type="checkbox"/> The Signal Cable is properly connected. <input type="checkbox"/> The signal timing of the computer is within the specification of the monitor.
(Power indicator is orange.)	<input type="checkbox"/> If the monitor is in standby mode, touch the keyboard or the mouse. <input type="checkbox"/> The computer is ON. <input type="checkbox"/> The Signal Cable is properly connected. <input type="checkbox"/> The signal timing of the computer is within the specification of the monitor.
② The screen is not synchronized.	<input type="checkbox"/> The Signal Cable is properly connected. <input type="checkbox"/> The signal timing of the computer is within the specification of the monitor.
③ The screen position is not in the center.	<input type="checkbox"/> The signal timing of the computer is within the specification of the monitor.
④ The screen is too bright or too dark.	<input type="checkbox"/> The video output level of the computer is within the specification of the monitor.
⑤ The screen is shaking.	<input type="checkbox"/> The power voltage is within the specification of the monitor. <input type="checkbox"/> The signal timing of the computer is within the specification of the monitor.

Problem

Check

- ⑥ No sound.
- The audio equipment (computer etc.) is ON.
 - The Audio Cable is properly connected.
 - The Volume is turned up.
 - The Mute is OFF.
 - The audio output level of the audio equipment is within the specification of the monitor.
- ⑦ The sound is too loud or too quiet.
- The audio output level of the audio equipment is within the specification of the monitor.
- ⑧ A strange noise is heard.
- The Audio Cable is properly connected.

RECYCLING INFORMATION

For better environment protection please don't dispose your monitor.
Please visit our web site: <https://iiyama.com> for monitor recycling.

APPENDIX

Design and specifications are subject to change without prior notice.

SPECIFICATIONS : ProLite XUB2495WSU-B7

Size Category	24"	
LCD Panel	Panel technology	IPS (In-Plane-Switching)
	Size	Diagonal: 24.1" (61.1cm)
	Pixel pitch	0.27mm H × 0.27mm V
	Brightness	300cd/m ² (Typical), 175cd/m ² (Default / Energy Saving)
	Contrast ratio	1000 : 1 (Typical), Adv. Contrast Function Available
	Viewable angle	Right / Left : 89 degrees each, Up / Down : 89 degrees each (Typical)
	Response Time	4ms (Gray to Gray) *2
Display Colors	Approx. 16.7M	
Sync Frequency	HDMI : Horizontal: 60.0-95.0kHz, Vertical: 48-75Hz DisplayPort : Horizontal: 60.0-95.0kHz, Vertical: 48-75Hz	
Native Resolution	1920 × 1200, 2.3 MegaPixels	
Support max. resolution	HDMI : 1920 × 1200, 75Hz DisplayPort : 1920 × 1200, 75Hz	
Input Connector	HDMI, DisplayPort	
Input Video Signal	HDMI, DisplayPort	
USB Standard	USB3.2 Gen 1 (5Gbps, DC5V, 900mA) × 3 USB Type-C USB3.2 Gen 1 (5Gbps, 5V, 3A) × 1	
Number of USB Ports Connector shape	1 Upstream : Type B 3 Downstream : Type A 1 Downstream: Type C	
Headphone Connector	ø 3.5mm mini jack (Stereo)	
Speakers	2W × 2 (Stereo speakers)	
Maximum Screen Size	518.4mm W × 324.0mm H / 20.21" W × 12.76" H	
Power Source	100-240VAC, 50/60Hz, 1.5A	
Power Consumption *1	17W typical, Standby mode: 0.5W maximum, Off mode: 0.3W maximum	
Dimensions / Net Weight	533.5 × 371.0 - 521.0 × 209.5mm / 21.0 × 14.6 - 20.5 × 8.2" (W×H×D) 4.9kg / 10.8lbs	
Height Adjustment Range	150mm	
Angle	Tilt: Upward: 23 degrees, Downward: 5 degrees Swivel: Left / Right: 45 degrees each Rotation: Clockwise / Counterclockwise: 90 degrees each	
Environmental Considerations	Operating: Temperature 5 to 35°C / 41 to 95°F Humidity 10 to 80% (No condensation) Storage: Temperature -20 to 60°C / -4 to 140°F Humidity 10 to 90% (No condensation)	
Approvals	TCO Certified, CE, UKCA, TÜV-GS, VCCI, PSE, EAC	

NOTE *1 When the USB devices are not connected.

*2 When set to Overdrive 5.

SPECIFICATIONS : ProLite XU2495WSU-B7

Size Category	24"	
LCD Panel	Panel technology	IPS (In-Plane-Switching)
	Size	Diagonal: 24.1" (61.1cm)
	Pixel pitch	0.27mm H × 0.27mm V
	Brightness	300cd/m ² (Typical), 175cd/m ² (Default / Energy Saving)
	Contrast ratio	1000 : 1 (Typical), Adv. Contrast Function Available
	Viewable angle	Right / Left : 89 degrees each, Up / Down : 89 degrees each (Typical)
	Response Time	4ms (Gray to Gray) *2
Display Colors	Approx. 16.7M	
Sync Frequency	HDMI : Horizontal: 60.0-95.0kHz, Vertical: 48-75Hz DisplayPort : Horizontal: 60.0-95.0kHz, Vertical: 48-75Hz	
Native Resolution	1920 × 1200, 2.3 MegaPixels	
Support max. resolution	HDMI : 1920 × 1200, 75Hz DisplayPort : 1920 × 1200, 75Hz	
Input Connector	HDMI, DisplayPort	
Input Video Signal	HDMI, DisplayPort	
USB Standard	USB3.2 Gen 1 (5Gbps, DC5V, 900mA) × 3 USB Type-C USB3.2 Gen 1 (5Gbps, 5V, 3A) × 1	
Number of USB Ports Connector shape	1 Upstream : Type B 3 Downstream : Type A 1 Downstream: Type C	
Headphone Connector	ø 3.5mm mini jack (Stereo)	
Speakers	2W × 2 (Stereo speakers)	
Maximum Screen Size	518.4mm W × 324.0mm H / 20.21" W × 12.76" H	
Power Source	100-240VAC, 50/60Hz, 1.5A	
Power Consumption *1	17W typical, Standby mode: 0.5W maximum, Off mode: 0.3W maximum	
Dimensions / Net Weight	533.5 × 426.0 × 190.0mm / 21.0 × 16.8 × 7.5" (W×H×D) 4.9kg / 10.8lbs	
Tilt Angle	Upward: 20 degrees, Downward: 4 degrees	
Environmental Considerations	Operating: Temperature 5 to 35°C / 41 to 95°F Humidity 10 to 80% (No condensation) Storage: Temperature -20 to 60°C / -4 to 140°F Humidity 10 to 90% (No condensation)	
Approvals	TCO Certified, CE, UKCA, TÜV-GS, VCCI, PSE, EAC	

NOTE *1 When the USB devices are not connected.

*2 When set to Overdrive 5.

DIMENSIONS : ProLite XUB2495WSU

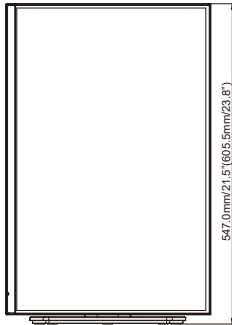
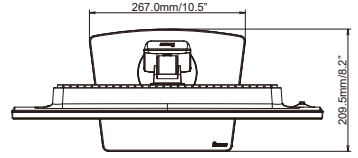
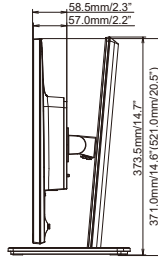
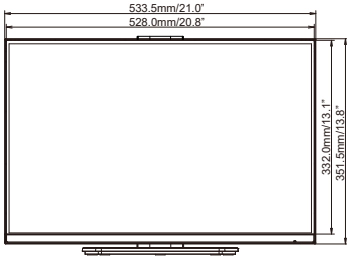

() : Maximum adjustment range

DIMENSIONS : ProLite XU2495WSU

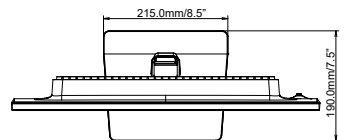
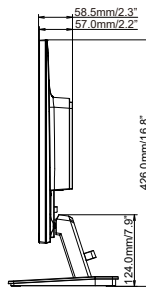
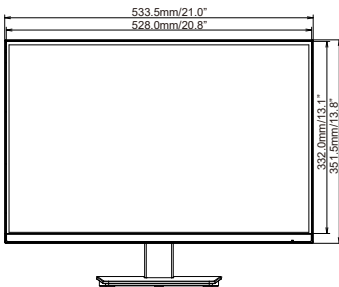

COMPLIANT TIMING

Video Mode	Horizontal Frequency	Vertical Frequency	Dot Clock
800 × 600	37.879kHz	60.317Hz	40.000MHz
	46.875kHz	75.000Hz	49.500MHz
1024 × 768	48.363kHz	60.004Hz	65.000MHz
	60.023kHz	75.029Hz	78.750MHz
1280 × 1024	63.981kHz	60.020Hz	108.000MHz
	79.976kHz	75.025Hz	135.000MHz
1680 × 1050	65.290kHz	60.000Hz	146.250MHz
1920 × 1080	67.500kHz	60.000Hz	148.500MHz
	83.890kHz	74.970Hz	174.500MHz
1920 × 1200	74.038kHz	59.950Hz	154.000MHz
	94.040kHz	74.930Hz	245.250MHz