



Poly Video Mode User Guide 4.1.0 (G7500, Studio X70, Studio X52, Studio X50, and Studio X30)

SUMMARY

This guide provides the end-user with task-based user information for the featured product.

Table of contents

1 About this guide.....	1
Audience, purpose, and required skills	1
Icons used in Poly documentation	1
2 Getting Started	2
Product Overview of Poly Video Systems	2
Poly G7500 System Features and Capabilities	2
Poly Studio X70 Features and Capabilities.....	2
Poly Studio X52 Features and Capabilities.....	3
Poly Studio X50 Features and Capabilities.....	4
Poly Studio X30 Features and Capabilities.....	4
Poly Studio E70 Camera Overview.....	5
Administrator Features and Capabilities	5
Navigating Your System	5
Access Poly Control Panel	5
Home Screen.....	5
Access the Home Screen While in an Application	6
Overview of system hardware	6
Poly G7500 Hardware.....	6
Poly G7500 System Ports.....	6
Poly Studio X70 Hardware.....	7
Poly Studio X70 System Hardware Ports	8
Poly Studio X70 Privacy Shutter Behavior.....	9
Poly Studio X52 Hardware.....	9
Poly Studio X52 System Ports.....	10
Poly Studio X52 Privacy Cover.....	10
Poly Studio X50 Hardware.....	11
Poly Studio X50 System Ports.....	11
Poly Studio X50 Privacy Cover.....	12
Poly Studio X30 Hardware.....	13
Poly Studio X30 System Ports.....	13
Poly Studio X30 Privacy Cover.....	14
Poly Studio E70 Camera Hardware	14
Poly Studio E70 Ports.....	14
Poly Studio E70 Privacy Shutter Behavior.....	15
LED Status Indicators	16

LED Status Indicators for the Poly G7500 System	16
LED Status Indicators for the Poly Studio X70 System	16
LED Status Indicators for the Poly Studio X52 System	17
LED Status Indicators for Poly Studio X50 and Poly Studio X30 Systems	17
LED Status Indicators for the Poly Studio E70 Camera.....	18
Powering the System On and Off.....	19
Navigating Your System.....	19
Home Screen	19
Content Screen	21
Poly IR Remote Control Button Functions	22
Bluetooth Remote Control Button Functions.....	23
Wake the System	24
Accessibility Features	24
Users Who Are Deaf or Hard of Hearing	24
Users Who Are Blind, Have Low Vision, or Have Limited Vision.....	25
Users with Limited Mobility	25
3 Calling	27
Placing Calls	27
Place a Call.....	27
Answer a Call.....	28
Ignore a Call.....	28
End a Call	28
Call a Password-Protected Zoom Meeting Using Trio C60	28
Calling Contacts	29
Call a Contact	29
Call a Frequent Contact.....	29
Call a Recent Contact.....	29
Calling Favorite Contacts	29
Favorite a Contact.....	30
Unfavorite a Contact	30
Call a Favorite Contact	30
Joining Meetings from the Calendar	30
Meeting Cards.....	30
View Meeting Cards.....	30
Join a Meeting from a Meeting Card.....	31
Join an Overbooked Meeting.....	31
Join a Password-Protected Meeting	31
4 Sharing Content	32
Sharing Content from a Computer or Device	32
Polycom Content App	32
Cast Content from an AirPlay- or a Miracast-Certified Device.....	32
Share Content Using an HDMI Connection	33
Sharing Content on a Blackboard or Whiteboard.....	33
Add a Blackboard or Whiteboard	33
Take a Snapshot of Your Content.....	33

Delete Snapshots or Content.....	34
End a Content Session	34
End a Call with Blackboard or Whiteboard Content	34
5 Cameras.....	35
Adjust an In-Room Camera.....	35
Adjust a Far-Site Camera.....	35
Turn Your Camera On or Off.....	36
Turn Camera Tracking On or Off	36
Using Camera Presets	36
Save a Camera Preset from the Local Interface.....	36
Select a Preset.....	37
Delete a Preset	37
Selecting the Primary Camera	37
Camera Priority	37
Select the Primary Camera from the Local Interface	38
6 Using device mode.....	39
Computer and cable requirements for Device Mode.....	39
Access Device Mode.....	39
Use your system as a computer accessory	40
Adjust the system audio and camera settings in Device Mode.....	40
Managing incoming calls when in Device Mode	41
Exit Device Mode and disconnect your computer	41
7 Using the Poly Control App	42
Control the System with the Poly Control App	42
8 Settings	43
Video Adjustments	43
Change the Participant Layout.....	43
Audio Adjustments	43
Mute Your Microphones.....	43
Unmute Your Microphones	44
Adjust the Volume.....	44
9 Troubleshooting.....	45
Poly Device Mode	45
Audio Levels are Too High or Low.....	45
Conferencing Application Doesn't Use System Camera or Audio	45
Can't Use System's Camera or Audio	45
Improve Audio Quality.....	46
Improve Laptop Screen Mirroring	46
Can't Share Wireless Content.....	46
View Content Help Tips.....	47

View Blackboard Help Tips	47
10 Getting help	48

1 About this guide





This section provides clarifying information about this guide.

Audience, purpose, and required skills

This guide is intended for beginning users, as well as intermediate and advanced users, who want to learn how to use the features available with G7500 and Studio X series.

Icons used in Poly documentation

This section describes the icons used in Poly Documentation and what they mean.

-
-  **WARNING!** Indicates a hazardous situation that, if not avoided, **could** result in serious injury or death.
 -  **CAUTION:** Indicates a hazardous situation that, if not avoided, **could** result in minor or moderate injury.
 -  **IMPORTANT:** Indicates information considered important but not hazard-related (for example, messages related to property damage). Warns the user that failure to follow a procedure exactly as described could result in loss of data or in damage to hardware or software. Also contains essential information to explain a concept or to complete a task.
 -  **NOTE:** Contains additional information to emphasize or supplement important points of the main text.
 -  **TIP:** Provides helpful hints for completing a task.
-

2 Getting Started

Before you use your system, familiarize yourself with its features and local interface.



NOTE: While you can control the system using a Poly TC8 or TC10 controller, all tasks in this guide apply to systems using the Bluetooth or IR remote control or a touch-sensitive monitor. For information on using your system with an attached TC8 device, see the [Poly TC8 User Guide](#) or [Poly TC10 User Guide](#).

Product Overview of Poly Video Systems

Poly G7500, Studio X70, Studio X52, Studio X50, and Studio X30 systems in Poly Video Mode support Poly video conferencing and content sharing features.

Poly G7500 System Features and Capabilities

G7500 systems support the following features:

- Peripheral cameras and microphones make the system scalable for medium rooms and up to large integrated rooms
- Placing and joining video calls
- Sharing wireless and wired content
- Camera tracking technology that can automatically zoom in on the person talking or frame the group of people in the room (depending on the paired camera and system configuration)
- Poly NoiseBlockAI, which eliminates background and extraneous sound during calls in common working environments
- Polycom Acoustic Fence technology, which enables video conferencing in open workspaces by capturing only the voices in a defined area
- HDMI: Single input and dual output
- Serial port connection
- Using a wired or wireless USB mouse as an input device

Poly Studio X70 Features and Capabilities

Poly Studio X70 Features and Capabilities

Studio X70 systems support the following features:

- All-in-one collaboration system for medium-to-large rooms
- No need for a separate PC, laptop, or codec to run video-conferencing software
- Placing and joining video calls
- Sharing wireless and wired content
- Dual built-in 4K cameras
- Camera tracking technology that automatically frames the group of people in the room
- Hi-fidelity, built-in stereo microphones that pick up sound within 7.62 m (25 ft) and use spatial audio for life-like presence and clarity
- Poly NoiseBlockAI, which eliminates background and extraneous sound during calls in common working environments
- HDMI: Single input and dual output
- Using a wired or wireless USB mouse as an input device

Poly Studio X70 Mounting Orientation

You can mount the Studio X70 above or below a display. The Studio X70 doesn't support inverted mounting. For information on mounting the Studio X70, see the Studio X70 setup sheet.

Poly Studio X52 Features and Capabilities

Studio X52 systems support the following features:

- All-in-one collaboration system for huddle rooms and small-to-medium rooms
- No need for a separate PC, laptop, or codec to run video-conferencing software
- Placing and joining video calls
- Sharing wireless and wired content
- Sharp 4K, 20MP camera with 95-degree horizontal field of view
- Camera tracking technology that automatically frames the group of people in the room
- Hi-fidelity, built-in stereo microphones that pick up sound within 7.62 m (25 ft) and use spatial audio for life-like presence and clarity
- Poly NoiseBlockAI, which eliminates background and extraneous sound during calls in common working environments
- Dual stereo speakers
- HDMI: Single input and dual output
- Simple to set up, manage, and use with Poly Lens

Poly Studio X52 Mounting Orientation

You can mount the Studio X52 above or below a display. The Studio X52 doesn't support inverted mounting. For information on mounting the Studio X52, see the *Poly Studio X52 Quick Start Guide*.

Poly Studio X50 Features and Capabilities

Studio X50 systems support the following features:

- All-in-one collaboration system for huddle rooms and small-to-medium rooms
- No need for a separate PC, laptop, or codec to run video-conferencing software
- Placing and joining video calls
- Sharing wireless and wired content
- Built-in 4K camera with ultra-wide 120-degree field of view
- Camera tracking technology that automatically frames the group of people in the room
- Hi-fidelity, built-in stereo microphones that pick up sound within 7.62 m (25 ft) and use spatial audio for life-like presence and clarity
- Poly NoiseBlockAI, which eliminates background and extraneous sound during calls in common working environments
- Dual stereo speakers
- HDMI: Single input and dual output
- Using a wired or wireless USB mouse as an input device

Poly Studio X50 Mounting Orientation

You can mount the Studio X50 above or below a display. The Studio X50 doesn't support inverted mounting. For information on mounting the Studio X50, see the Studio X50 setup sheet.

Poly Studio X30 Features and Capabilities

Studio X30 systems support the following features:

- All-in-one collaboration system for huddle rooms and small-to-medium rooms
- No need for a separate PC, laptop, or codec to run video-conferencing software
- Placing and joining video calls
- Sharing wireless and wired content
- Built-in 4K camera with ultra-wide 120-degree field of view
- Camera tracking technology that automatically frames the group of people in the room
- High-fidelity, built-in stereo microphones that pick up sound within 4.57 m (15 ft) and use spatial audio for life-like presence and clarity
- Poly NoiseBlockAI, which eliminates background and extraneous sound during calls in common working environments
- Single mono speaker
- HDMI: Single input and output
- Using a wired or wireless USB mouse as an input device

Poly Studio X30 Mounting Orientation

You can mount the Studio X30 above or below a display. The Studio X30 supports inverted mounting. For information on mounting the Studio X30, see the Studio X30 setup sheet.

Poly Studio E70 Camera Overview

Poly Studio E70 is a dual-camera solution supported on Poly G7500, Studio X70, Studio X52, and Studio X50 systems.

The Poly Studio E70 includes the following features:

- Standalone USB 4K camera with full tracking and framing capabilities
- Visual coverage up to 7.6 m (25 ft)
- Microphones that provide accurate sound source location to support camera tracking

Administrator Features and Capabilities

The G7500 and Studio X Family systems provide features for administrators to deploy, manage, and access systems.

These systems provide the following features and capabilities:

- Remote access for managing standalone systems
- Provisioning with Poly Clariti Manager to support single system, small business, and large multisite enterprise deployments
- SNMP reporting and remote logging
- Industry-standard security techniques, including 802.1X authentication
- Polycom platform on-premises infrastructure and management solutions
- Standards-based video conferencing (SIP and H.323)
- Customizable home screen and monitor layouts

Navigating Your System

The system has a control panel to help you navigate and understand important information on the state of your system.

Access Poly Control Panel

Use the Poly control panel to access additional functions of your system.

- From the right border of your screen, swipe left.

Home Screen

Use the *Home* screen to access installed applications on your system by selecting their respective icons.

Access the *Home* Screen While in an Application

While using an application, you can return to the *Home* screen.

1. Do one of the following:
 - From the far right border of the screen, swipe left.
 - On your remote control, press **Menu** .
2. Select **Home**.

Overview of system hardware

The figures and tables in the following topics provide information about hardware features available on your system.

Poly G7500 Hardware

The following figure displays the hardware features on the Poly G7500 system. The table lists each feature numbered in the figure.

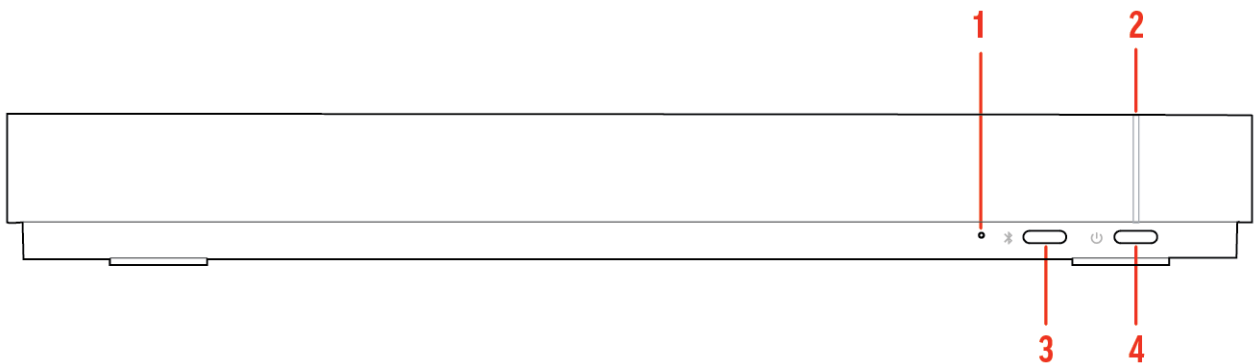

Table 2-1 Poly G7500 Feature Descriptions

Ref. Number	Feature	Feature Description
1	Reset button	Resets the Poly G7500 to the factory software version
2	LED indicator	Indicates the system status
3	Remote control pairing button	Enables the Bluetooth remote control pairing mode
4	Restart button	Restarts your system

Poly G7500 System Ports

The following illustration and table explain the ports on the back panel of your G7500 system.

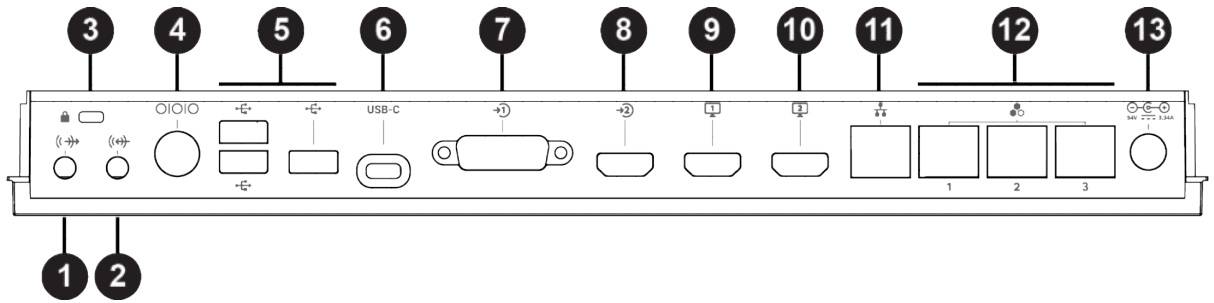

Table 2-2 G7500 System Port Descriptions

Ref. Number	Port Description
1	3.5 mm audio line out
2	3.5 mm audio line in
3	Security lock
4	Mini-DIN/RS-232 serial port NOTE: The serial port is occasionally used by third party control system devices for automation.
5	USB-A ports
6	USB-C port
7	HDCI input for Polycom cameras
8	HDMI input for sharing content (for example, from a laptop)
9	HDMI output for the primary monitor
10	HDMI output for the secondary monitor
11	LAN connection for the system
12	Link-local network (LLN) connections for IP-based peripheral devices
13	Power cord port

Poly Studio X70 Hardware

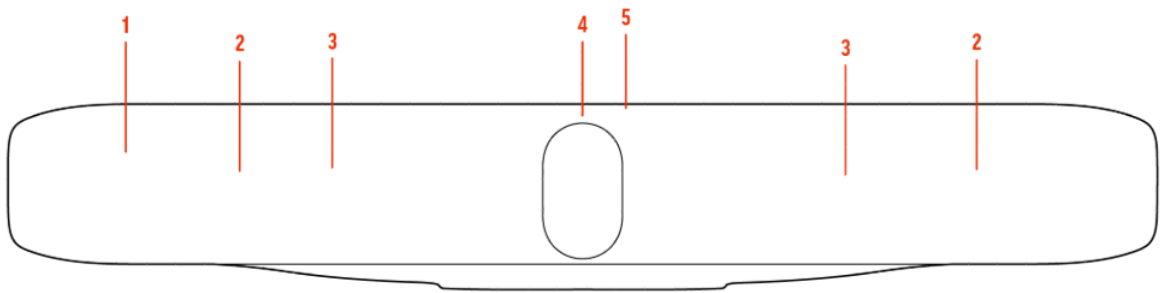

Table 2-3

Ref. Number	Feature	Description
1	Screen	Protective screen that covers the front of the system

Table 2-3 (continued)

Ref. Number	Feature	Description
2	Microphone array	Microphone array that captures audio
3	Speakers	Stereo audio output
4	Dual cameras	Camera array with a privacy shutter that automatically opens or closes, depending on the camera state
5	LED indicators	Indicates the system status and information on the tracked speaker

Poly Studio X70 System Hardware Ports

The following illustration and table explain the hardware ports on your Poly Studio X70 system.

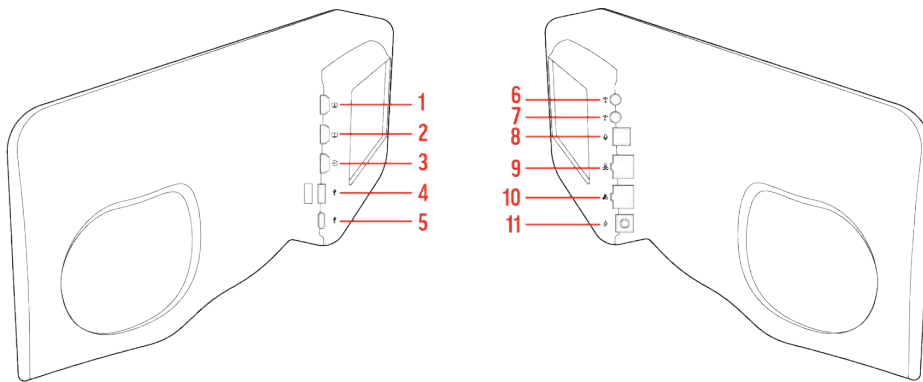



Table 2-4 Poly Studio X70 System Hardware Port Descriptions

Ref. Number	Port Description
1	HDMI output for the secondary monitor
2	HDMI output for the primary monitor
3	HDMI input for sharing content (for example, from a laptop)
4	USB-A ports
5	USB-C port
6	3.5 mm audio line in
7	3.5 mm audio line out
8	Expansion microphone connection
9	LAN connection for the system
10	Link-local network (LLN) connections for IP-based peripheral devices NOTE: This port is disabled and is reserved for future use.
11	Power cord port

Poly Studio X70 Privacy Shutter Behavior

The privacy shutter automatically opens and closes depending on the state of the connected video system.

Poly Studio X70 Privacy Shutter Behavior

 **NOTE:** Shutter behavior may vary depending on the partner application.

System Event	Shutter Behavior
The system powers on	Shutters open
The system powers off	Shutters close NOTE: If you remove power immediately, the shutters don't close.
The system enters sleep mode or digital signage starts and the Camera Sleep Setting is set to Save Energy	Shutters close
The system enters sleep mode or digital signage starts and Camera Sleep Setting is set to Fast Wake	Shutters remain open NOTE: When Fast Wake is set, the shutters never close.
You wake the system	Shutters open
You wake the system and the Studio X70 built-in camera isn't the primary camera	Shutters remain closed
You select the Studio X70 built-in camera as the primary camera	Shutters open
The system receives an incoming call	If the shutters are closed, they remain closed until the call is answered
The system is sending video	Shutters are open
The system is in an active call and the video is muted	Shutters are open

Poly Studio X52 Hardware

The following figure displays the hardware features on the Poly Studio X52 system. The table lists each feature numbered in the figure.

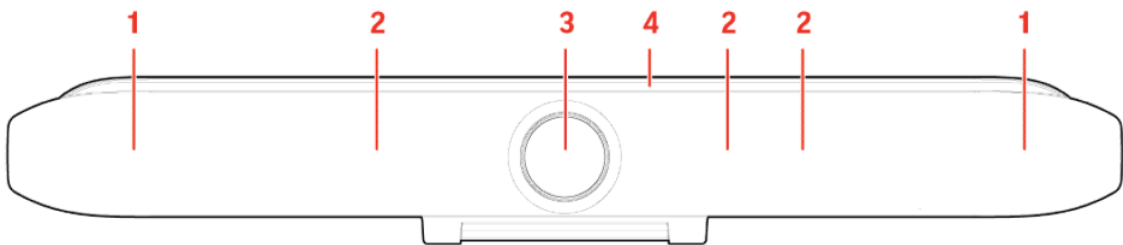

Table 2-5 Poly Studio X52 Feature Descriptions

Ref. Number	Feature	Feature Description
1	Speaker	Stereo audio output
2	Microphone array	Microphone array that captures audio

Table 2-5 Poly Studio X52 Feature Descriptions (continued)

Ref. Number	Feature	Feature Description
3	Camera	Camera with a privacy cover that enables or disables the video input as you choose
4	LED indicators	Indicates the system status and information on the tracked speaker

Poly Studio X52 System Ports

The following illustration and table explain the ports on your Poly Studio X52 system.

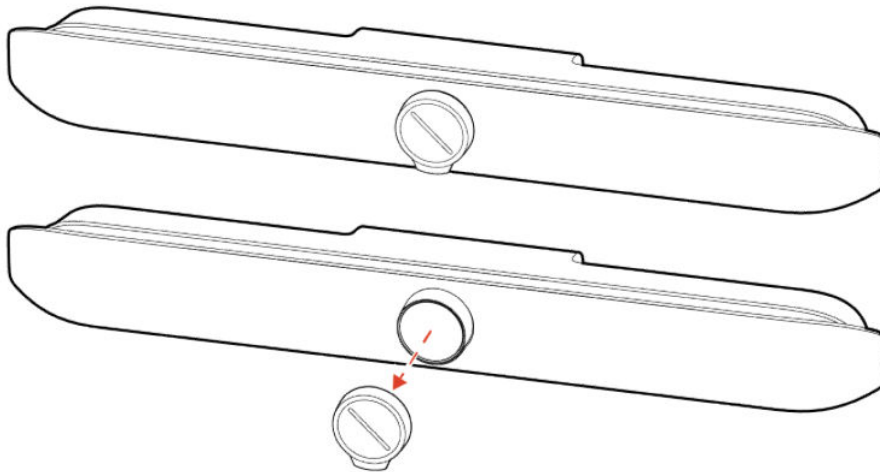

Table 2-6 Poly Studio X52 System Port Descriptions

Ref. Number	Port Description
1	Poly Table Expansion Microphone connection
2	USB-A ports
3	RJ45 Ethernet port
4	Power port
5	HDMI port for secondary monitor
6	HDMI port for primary monitor
7	HDMI port for content sharing and Device Mode
8	USB-C port for Device Mode

Poly Studio X52 Privacy Cover

The Poly Studio X52 system provides a physical cover that you can place over the camera lens to protect your privacy.



Poly Studio X50 Hardware

The following figure displays the hardware features on the Poly Studio X50 system. The table lists each feature numbered in the figure.

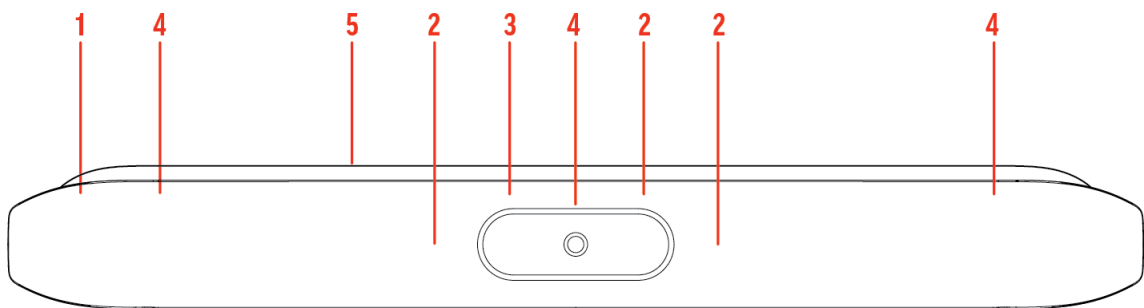

Table 2-7 Poly Studio X50 Feature Descriptions

Ref. Number	Feature	Feature Description
1	Screen	Protective screen that covers the front of your system
2	Microphone array	Microphone array that captures audio
3	Camera	Camera with a privacy cover that enables or disables the video input as you choose
4	Speakers	Stereo audio output
5	LED indicators	Indicates the system status and information on the tracked speaker

Poly Studio X50 System Ports

The following illustration and table explain the ports on your Poly Studio X50 system.

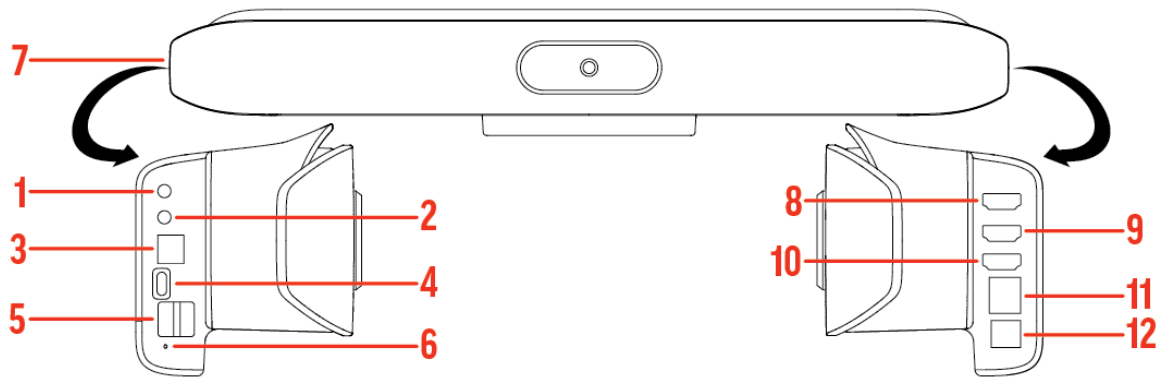
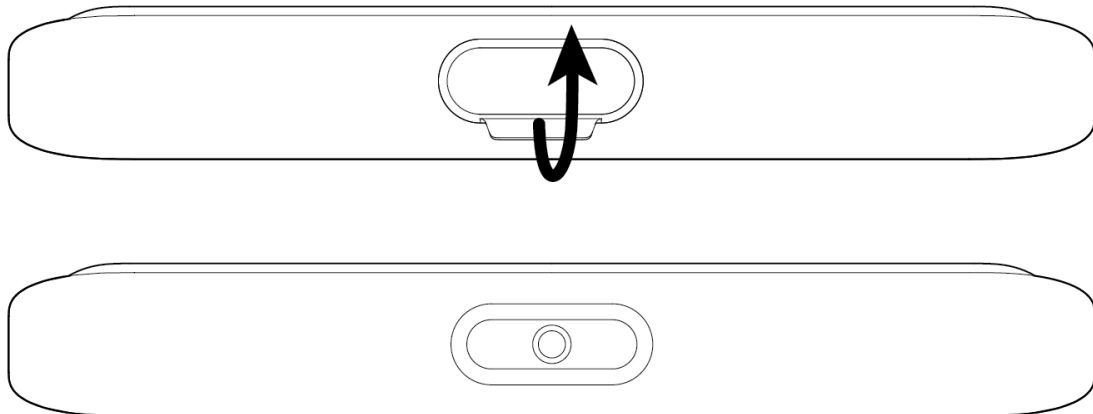

Table 2-8 Poly Studio X50 System Port Descriptions

Ref. Number	Port Description
1	3.5 mm audio line in
2	3.5 mm audio line out
3	Polycom RealPresence Debut expansion microphone connection
4	USB-C port
5	USB-A ports
6	Factory restore pinhole
7	Security lock (on the back flat section of the system)
8	HDMI output for the secondary monitor
9	HDMI output for the primary monitor
10	HDMI input for sharing content (for example, from a laptop)
11	LAN connection for the system
12	Power cord port

Poly Studio X50 Privacy Cover

The Poly Studio X50 provides a physical cover that you can place over the camera lens to protect your privacy.



Poly Studio X30 Hardware

The following figure displays the hardware features on the Poly Studio X30 system. The table lists each feature numbered in the figure.

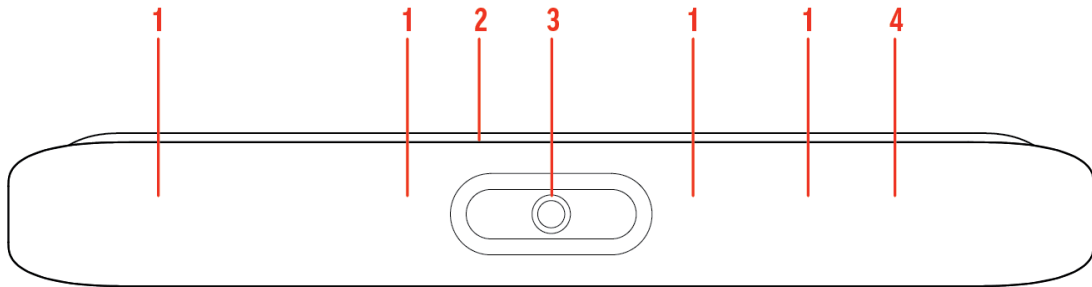

Table 2-9 Poly Studio X30 Feature Descriptions

Ref. Number	Feature	Feature Description
1	Microphone array	Microphone array that captures audio
2	LED indicators	Indicates the system status and information on the tracked speaker
3	Camera	Camera with a privacy cover that enables or disables the video input as you choose
4	Speaker	Mono audio output

Poly Studio X30 System Ports

The following illustration and table explain the ports on your Poly Studio X30 system.

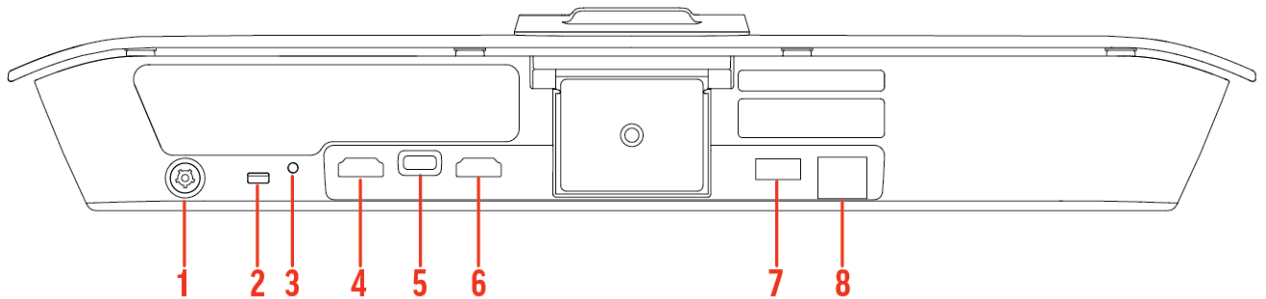
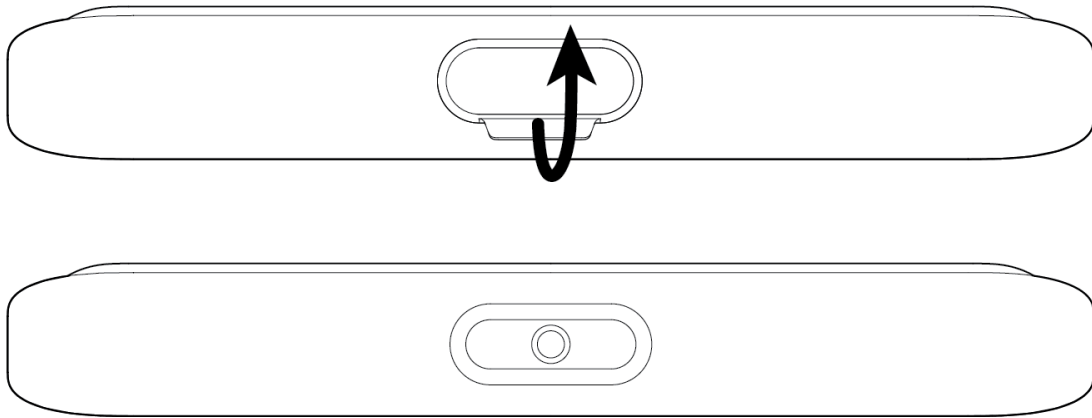

Table 2-10 Poly Studio X30 System Port Descriptions

Ref. Number	Port Description
1	Power cord port
2	Security lock
3	Factory restore pinhole
4	HDMI output for the primary monitor
5	USB-C port
6	HDMI input for sharing content (for example, from a laptop)
7	USB-A ports
8	LAN connection for the system

Poly Studio X30 Privacy Cover

The Poly Studio X30 provides a physical cover that you can place over the camera lens to protect your privacy.



Poly Studio E70 Camera Hardware

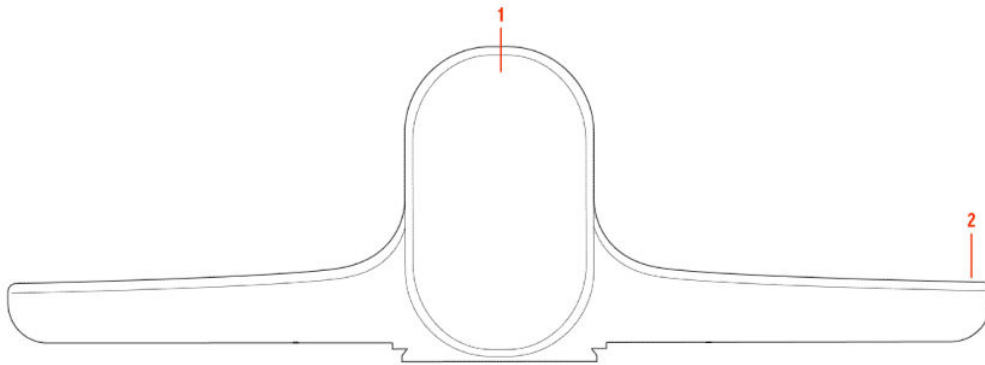

Table 2-11 Poly Studio E70 Feature Descriptions

Reference Number	Feature	Description
1	Dual-cameras	Camera array with a privacy shutter that automatically opens or closes depending on the camera state
2	LED indicators	Front and right indicators that show the status of the camera

Poly Studio E70 Ports

The following illustration and table explain the ports on your Poly Studio E70 camera.

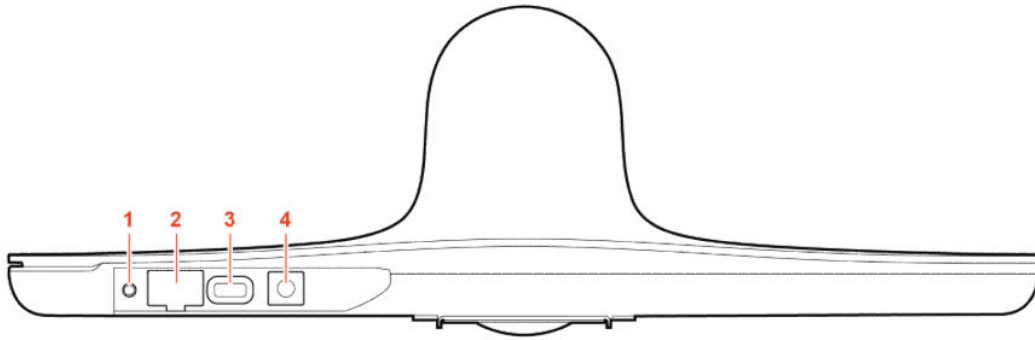

Table 2-12 Poly Studio E70 Port Descriptions

Ref. Number	Port Description
1	Reset button
2	Ethernet port (Can be used to provide power to the camera)
3	USB-C port
4	Power cord port

Poly Studio E70 Privacy Shutter Behavior

The privacy shutter automatically opens and closes depending on the state of the connected video system.



NOTE: Shutter behavior may vary depending on the partner application.

System Event	Shutter Behavior
The system powers on	Shutters open
The system powers off	Shutters close NOTE: If you remove power immediately, the shutters don't close.
The system enters sleep mode or digital signage starts and the Camera Sleep Setting is set to Save Energy	Shutters close
The system enters sleep mode or digital signage starts and Camera Sleep Setting is set to Fast Wake	Shutters remain open NOTE: When Fast Wake is set, the shutters never close.
You wake the system	Shutters open
You wake the system and the Studio E70 isn't the primary camera	Shutters remain closed
You select the Studio E70 as the primary camera	Shutters open
The Studio E70 isn't the primary camera and is idle for five minutes	Shutters close
The system receives an incoming call	If the shutters are closed, they remain closed until the call is answered
The system is sending video	Shutters are open

System Event	Shutter Behavior
The system is in an active call and the video is muted	Shutters are open

LED Status Indicators

The following topics list the LED behavior for your system. The tables list each LED indicator and its associated status.

LED Status Indicators for the Poly G7500 System

Use the LED on the front right corner of the codec to get information on the state of your system.

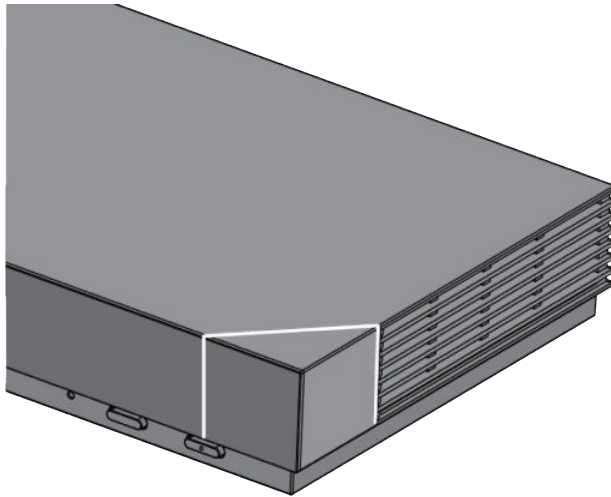

Table 2-13 Poly G7500 System LED Status Indicators

Indicator	Status
Blinking white	Powering on
Solid white	Working normally
Solid green	In a call
Blinking amber	Update in progress.
Solid amber	Sleeping
Blinking red	Error preventing normal operation
Solid red	Muted microphone

LED Status Indicators for the Poly Studio X70 System

Use the LED on the right side of the system to help you understand the system's behaviors.

Table 2-14 Poly Studio X70 LED Indicators and Status

Indicator	Status
Solid white	Device is idle and standing by
Pulsing white	Boot initiation in progress

Table 2-14 Poly Studio X70 LED Indicators and Status (continued)

Indicator	Status
Pulsing amber	Firmware update or factor restore in progress
Blinking blue and white	Bluetooth pairing
Solid blue	Bluetooth paired
Solid green	Active call in progress
Solid red	Audio mute

LED Status Indicators for the Poly Studio X52 System

Use the LED on the right side of the system to help you understand the system's behaviors.

Table 2-15 Poly Studio X52 LED Indicators and Status

Indicator	Status
Off	System powered off
Off	System in sleep mode
Solid white	System is idle and standing by
Pulsing white	Boot initiation in progress
Pulsing amber	Firmware update or factor restore in progress
Blinking blue and white	Bluetooth pairing
Solid blue	Bluetooth paired
Solid green	Active call in progress
Solid red	Audio is muted

LED Status Indicators for Poly Studio X50 and Poly Studio X30 Systems

The system provides an LED light bar above the camera to help you understand the system's behaviors.

Table 2-16 Poly Studio X50 and Studio X30 LED Indicators and Status

Indicator	Position	Status
Solid white	All	Boot initialization in progress
Blinking blue	Twelve in the middle	Bluetooth in discover
Solid blue for 3 seconds	All	Bluetooth paired
Blinking green	All	Incoming call
Solid green	All	Outgoing call

Table 2-16 Poly Studio X50 and Studio X30 LED Indicators and Status (continued)

Indicator	Position	Status
Solid green	Four to eight (when in the middle), indicating the tracked speaker or the direction of the camera	Working The lights are green with supported applications in the following cases: <ul style="list-style-type: none"> Tracking people in group framing and speaker tracking mode Indicating the direction of the camera that you customize in pan-tilt-zoom (PTZ) mode
Solid amber	Twelve in the middle	Standing by System in sleep mode with no active video output
Pulsing red	Twelve in the middle	Call on hold
Pulsing green	Twelve in the middle	Call on hold (by far site)
Solid white for 3 seconds	Twelve in the middle	Saving a preset
Solid red	All	Muted microphone
Solid red	Four in the middle	Muted camera Muted microphone LEDs take precedence over camera mute LEDs
Pulsing amber	All	Firmware update in progress
Blinking red	All	Error preventing normal operation
Blinking amber	Twelve alternating	In a POST sequence, at least one test results in a warning error. The system continues to blink amber but initializes after the sequence is complete if no severe errors occur.

LED Status Indicators for the Poly Studio E70 Camera

The camera provides LED indicators on the front and right side of the camera to help you understand the camera's behaviors when connected to a Poly G7500 system, Poly Studio X video bar, or a Windows PC.

Table 2-17 Poly Studio E70 Camera System LED Status Indicators

Color and Pattern	Status
Pulsing white	Boot initialization is in progress
Solid white (50% brightness)	Powered on but disconnected from video system Sleep mode
Solid white (100% brightness)	Powered on and connected to the video system
Solid green	In a call or the camera is active
Pulsing amber	Firmware update or factory reset in progress

Table 2-17 Poly Studio E70 Camera System LED Status Indicators (continued)

Color and Pattern	Status
Flashing blue	Camera is IP pairing

NOTE: If LED continues to flash blue, unplug and then replug the Poly Studio E70 camera.

Powering the System On and Off

The system powers on when you plug it in to a power source.

Poly recommends the following when powering off or restarting your system:

- Don't restart or power off the system during maintenance activities (for example, while a software update is in progress).
- If a system restart is necessary, use the system web interface, RestAPI, Telnet, or SSH. If possible, avoid using the power cable to restart the system.

Navigating Your System

The system has icons and user screens to help you navigate and understand important information about your system.

Home Screen

The Home screen is the first screen you encounter on the system monitor. From this screen, you have quick access to many of the system functions.



NOTE: Some elements of your screen may be different depending on the system configuration.

Home Screen

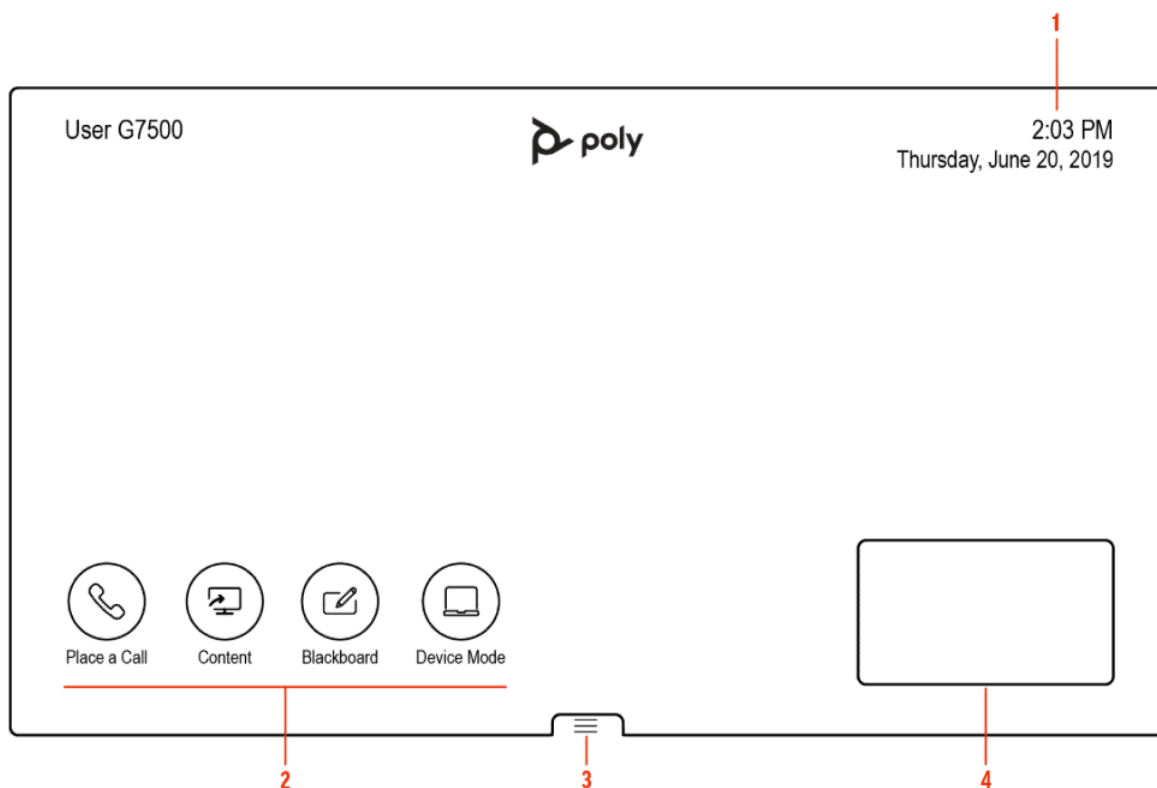







Ref. Number	Description
1	System information bar, which shows details such as date/time and system name.
2	Task buttons for placing calls, sharing content, creating a blackboard, or launching Poly Device Mode.
3	Menu for accessing other features.
4	Local camera view.

Home Screen Elements

Some of the following interactive and read-only elements might not display on your system depending on the system configuration.

Element	Description
Name	Descriptive name determined by the system administrator. Used when you want to connect to a system.
Security code	Displays after you attempt a content sharing connection. Use the four-digit code to set up wireless connections through the Polycom Content App or an AirPlay- or a Miracast-certified device.
IP address	IP address, SIP, H.323, or secondary network configured for your system.
Current time	Local time zone.

Element	Description
Current date	Local time zone date.
Warning 	Notification that the system has detected one or more problems that might prevent it from fully functioning.
Calendar or Favorites cards	View your calendar or favorites.
Place a Call 	Opens a call screen where you can dial a call, or you can select a card to dial numbers, access favorites, or view your calendar.
Content 	When content is available, the system displays a list of available content. Otherwise, this function opens a help screen that describes how to set up content sharing using HDMI, the Polycom Content App, or an AirPlay- or a Miracast-certified device.
Blackboard 	Creates a new blackboard, where you can share annotations or drawings.
Poly Device Mode 	Launches Poly Device Mode, which allows you to use the Poly Video system as an external camera, microphone, and speaker for your connected laptop.
Menu 	Opens new menu selections for calling, sharing content, camera control, and additional functions.

Content Screen

The Content screen is where you share and annotate content in your meetings.

Content Screen

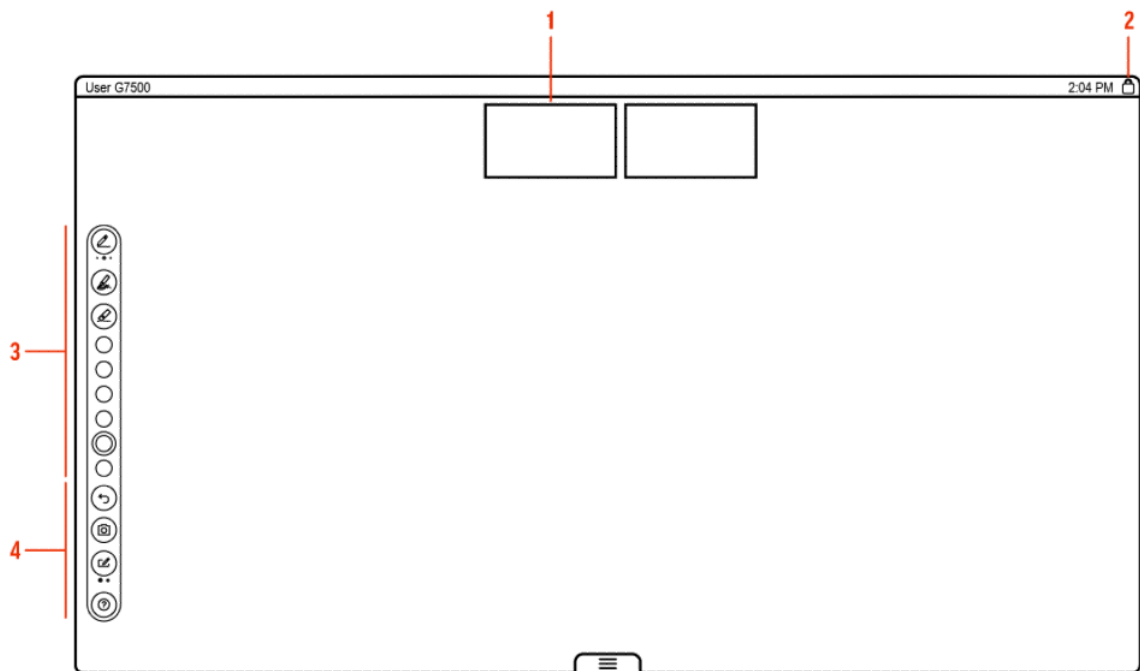

Ref. Number	Description
1	Camera views of call participants.
2	System information bar, shows system information such as system name and time.

Ref. Number	Description
3	Content toolbar, provides tools to annotate and work with content.
4	Content management functions.

Poly IR Remote Control Button Functions

When you connect a Poly IR receiver to your G7500 or Studio X system, you can use the Poly IR remote control to navigate your system.

The following illustration and table show the buttons and functionality of the Poly IR remote control.

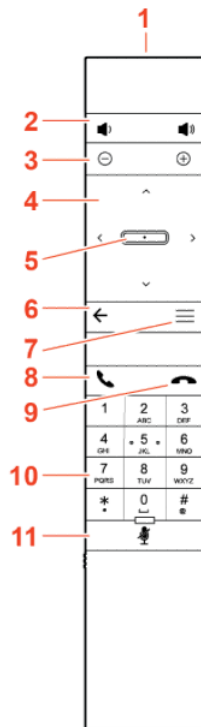

Table 2-18 IR Remote Button Functions

Item	Description	Function
1	IR LED	Sends IR signals to the IR receiver
2	Volume	Increase or decrease the volume
3	Camera zoom	Zoom the camera in or out
4	Navigation controls	Navigate the user interface.
5	Select	Select an item on the user interface or adjust a toggle
6	Back arrow	Return to the previous screen
7	Menu	In Poly Video mode only, show or hide the settings and camera controls
8	Call	Display the calls screen or answer an incoming call

Table 2-18 IR Remote Button Functions (continued)

Item	Description	Function
9	End call	End an active call or reject an incoming call
10	Dialpad	Dial a number
11	Mute	Mute or unmute the system microphones

Bluetooth Remote Control Button Functions

When you pair the Poly Bluetooth remote control with your G7500 or Studio X system, you can use the remote control to navigate your system.

The following illustration and table show the buttons and functionality of the Bluetooth remote control. The functionality is specific to Poly Video mode.

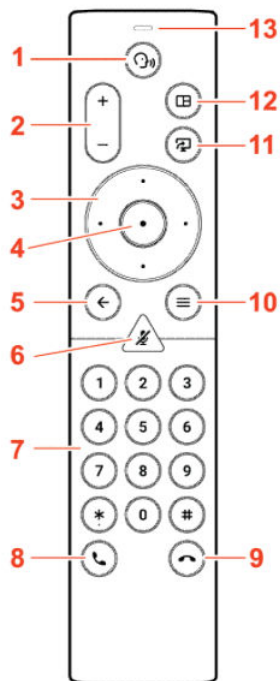

Table 2-19 IR Remote Button Functions

Item	Description	Function
1	Voice Assistant	Feature planned for future use
2	Volume or zoom	Adjust volume up and down or, in camera mode, zoom the camera in or out
3	Navigation controls	Navigate the screen In camera mode, controls camera pan and tilt
4	Select	Select an item on the user interface or adjust a toggle
5	Back arrow	Return to the previous screen

Table 2-19 IR Remote Button Functions (continued)

Item	Description	Function
6	Mute	Mute the system microphones. Long press to pair the remote control with the system
7	Keypad	Dial a number. Select camera presets while in a call in
8	Call button	Display the calls screen or answer an incoming call
9	End call	End an active call, reject an incoming call, or end a meeting
10	Menu	Open the available system menu to access features
11	Present content	From the home screen, display the content help screen In a meeting, open the content tray and select available content to share
12	Layout	Open the layout screen to choose how two or more participants display on the screen
13	Voice Assistant Microphone	Feature planned for future use

Wake the System

After a period of no activity, the system enters sleep mode (if configured by your administrator). You can wake it using a touch monitor, Poly TC8, or Poly Bluetooth Remote Control.

- Do one of the following:
 - If you're using a touch monitor, tap the primary screen.
 - If you're using the TC8, tap the screen.
 - If you're using a Poly Trio, tap the screen.
 - Press any button on the remote control.

Accessibility Features

Poly products include a number of features to accommodate users with disabilities.

Users Who Are Deaf or Hard of Hearing

Your system includes accessibility features so that users who are deaf or hard of hearing can use the system.

The following table lists the accessibility features for users who are deaf or hard of hearing.

Table 2-20 Accessibility Features for Users Who Are Deaf or Hard of Hearing

Accessibility Feature	Description
Visual notifications	Status and icon indicators let you know when you have incoming, outgoing, active, or held calls. Indicators also alert you of the device's status and when features are enabled.
Status indicator lights	The system and its microphones use LEDs to indicate some statuses, including if your microphones are muted.

Table 2-20 Accessibility Features for Users Who Are Deaf or Hard of Hearing (continued)

Accessibility Feature	Description
Adjustable call volume	While in a call, you can raise or lower the volume of the device.
Auto-answering	You can enable the system to auto-answer calls.

Users Who Are Blind, Have Low Vision, or Have Limited Vision

Your system includes accessibility features so that users who are blind, have low vision, or have limited vision can use the system.

The following table lists the accessibility features for users who are blind, have low vision, or have limited vision.

Table 2-21 Accessibility Features for Users Who Are Blind, Have Low Vision, or Have Limited Vision

Accessibility Feature	Description
Auto-answering	You can enable the system to auto-answer calls.
Mute auto-answered calls	You can configure the system to mute auto-answered calls.
Ringtones	An audible tone plays for incoming calls.
Adjustable backlight settings	You can change the brightness of the screen by adjusting backlight intensity settings.
Visual notifications	Status and icon indicators let you know when you have incoming, outgoing, active, or held calls. Indicators also alert you of the device's status and when features are enabled.
Join and leave tones	The system plays a tone when someone joins or leaves a conference call.
Embossed buttons	The remote control has embossed push buttons for performing common tasks with the system, such as dialing a number.

Users with Limited Mobility

Your system includes accessibility features so that users with limited mobility can use various system features.

The following table lists the accessibility features for users with limited mobility.

Table 2-22 Accessibility Features for Users with Limited Mobility

Accessibility Feature	Description
Remote control	The Bluetooth remote control enables you to control the system and to perform tasks such as placing calls, starting a sharing session, and configuring some settings.
Alternative control interface	This product provides an alternative control interface for the connected video conferencing system for people with disabilities that cause limited manipulation issues.
Poly TC8	The TC8 enables you to control the system and to perform tasks such as placing calls.
Auto-answering	You can enable the system to auto-answer calls.

Table 2-22 Accessibility Features for Users with Limited Mobility (continued)

Accessibility Feature	Description
Calling from a personal device	With administrator credentials, you can wirelessly access the system web interface from your own device to make calls and manage contacts and favorites.
Touch-capable monitor support	If you have a touch-capable monitor connected to the system, you can select, swipe, and press the screen to perform functions and activate features.
Flexible mounting/display configurations	Product isn't stationary and can be mounted or displayed in various configurations. Touch controls require minimal strength to operate.

3 Calling

There are several ways to initiate calls on the system. You can place a call by entering your contact's name or number, choosing a contact in the directory, calling a favorite or recent contact, or joining a scheduled meeting.

You can place calls using the following methods:

- Call using the dialpad
- Call a contact
- Call a frequently used number
- Call a recent contact
- Call a favorite
- Join a meeting from the calendar
- Call using a USB-connected Windows or Mac device

Placing Calls



You can place audio calls, video calls, and call into meetings using the onscreen keyboard.

Use the following dialing formats when placing calls:

- IPv4 address: 192.0.2.0
- Host name: room.company.com
- SIP address: user@domain.com
- H.323 or SIP extension: 2555
- Phone number: 9782992285

Place a Call

You can place an audio or video call to a contact.

1. Go to **Place a Call**.
2. On the **Dialpad**  screen, move the slider to **Audio**  or **Video** .

3. Enter a number on the dialpad or select **Keyboard**  to enter characters.
4. Select **Call**.

Answer a Call

The way the system handles incoming calls depends on how your administrator configured it. The system either answers the call automatically or prompts you to answer manually.

- If you receive an incoming call notification, select **Answer**.



Ignore a Call

If the system doesn't answer incoming calls automatically, you can choose to ignore the call rather than answer it.

- If you receive an incoming call notification, select **Ignore**.

End a Call

When your call is complete, hang up the call. If you have content such as blackboards, whiteboards, or snapshots, the system asks if you want to keep them.

- In a call, do one of the following:
 - On your remote control, press **Hang Up** .
 - On the screen, select **Menu**  > **Hang Up**.

Call a Password-Protected Zoom Meeting Using Trio C60

Use these input options when calling into a password-protected Zoom meeting when using Poly Video Mode and a paired Trio C60.

Make sure that you have the meeting password before you join.

 **IMPORTANT:** If you choose the option to enter the password separately from the dial string, you must enter a pound sign (#) before you enter the password on a Trio C60 system. If you don't enter the pound sign, the call doesn't connect.

1. On your Trio C60 controller, select **Dialpad** .
2. Do one of the following:
 - Enter the Zoom Rooms dialing sequence. When the system prompts you for the password, press the pound sign before entering the meeting password.
For example, enter `<meetingID>@zoomcrc.com`, then enter `#<password>`.
 - Enter the Zoom Rooms meeting password as part of the dialing sequence.
For example, enter `<meetingID>.<password>@zoomcrc.com`.
3. Select **Call**.

Calling Contacts

You can access and call contacts, recent contacts, and frequent contacts on your system.

If configured by your administrator, contacts display on the *Place a Call* screen. Contact cards can display the following information:

- Contact name
- Contact number
- Contact email address
- Contact IP address

Call a Contact

To quickly dial a contact, you can search and select a contact card from the results. Contact cards display for frequent contacts, directory contacts, and favorites.

1. Using the controller or remote control, select **Place a Call > Contact**.
2. In the search field, use the onscreen keyboard to type characters or numbers and select **Search**.
3. Select a contact card to view contact details.
4. Select **Call**.

Call a Frequent Contact

As you place calls, the system learns your frequently-used contacts and displays them in a list.

1. Using the touch screen or remote control, select **Place a Call**.
2. Select a contact card from the **Frequent** list.

The call automatically dials.

Call a Recent Contact

You can quickly call recent contacts from a list (organized by most to least recent).

1. Go to **Place a Call > Recent**.
2. Scroll through the list of recent contacts (sorted by date) and select one.

The call automatically dials.

Calling Favorite Contacts

To quickly access a short list of contacts you call most often, create favorites.

Favorites display on the *Favorites*, *Contacts*, or *Home* screens, depending on your system configuration. The system adds a star icon next to the contact's name, providing you an easy way to identify and call favorites.

Favorite a Contact

Create favorites to display contacts that you call the most often.

1. Go to **Place a Call > Contacts**.
2. Select a contact card, then select **Favorite**.

The contact receives a star icon and displays in the **Contacts** and **Favorites** lists.

Unfavorite a Contact

Unfavorite a contact to remove the contact from your **Favorites** list.

1. Go to **Place a Call > Favorites**.
2. Choose a favorite card, then select **Unfavorite**.

The contact is removed from the **Favorites** list.

Call a Favorite Contact

To quickly call a contact, select a favorite card.

1. Select a favorite card on the *Favorites*, *Contacts*, or *Home* screen.
2. Select **Call**.

Joining Meetings from the Calendar

On the *Home* screen, you can join meetings directly from your calendar using the meeting cards on the screen (if configured).



NOTE: If calendaring isn't configured for your system, the system doesn't display meeting cards. You must dial manually to join meetings.

Meeting Cards

If configured, meeting cards display on the *Home* screen. You can access meeting cards to view meeting details.

Meeting cards display the following scheduling information:

- All-day meetings display as the first meeting card.
- For meetings scheduled later in the day, a **Free until [time/day]** message displays, followed by upcoming meeting cards in the time and date order they're scheduled.
- For meetings scheduled later in the week, a **Free until [time/day]** message displays until the day of the next scheduled meeting.
- If there are no scheduled meetings for the current week, a **No Meetings** message displays.

View Meeting Cards

On the *Home* screen, you can view meeting cards that show your calendar event details. Meeting cards display meeting times, subjects, and organizers.



NOTE: Private meetings are labeled **Private Meeting**. Except for the time, meeting details are hidden.

- Do one of the following:
 - To view meeting information, choose a meeting card and select **Info**.
 - To view upcoming scheduled meetings, select a card and scroll to the right.

Join a Meeting from a Meeting Card

On the *Home* screen, you can select a meeting card for options to join a meeting.

The system supports automatic dialing if the meeting organizer added calling information to the calendar event and your administrator has configured calendaring.

- Do one of the following:
 - On a current meeting card, select **Join**.
 - If the meeting card doesn't include calling information, select **More ...** the card to display the dialpad. Dial the number to join the meeting.

Join an Overbooked Meeting

If two or more meetings are scheduled at the same time, the meetings display as **Overbooked**. You can join one of the meetings using its individual meeting card.

1. Select an overbooked meeting card and choose **Info**.

The individual meeting cards display.
2. Choose one of the meeting cards and select **Join** to connect to the meeting.

Join a Password-Protected Meeting

Some meetings may require a password to join.

Make sure that you have the password for password-protected meetings before you join. If you don't have a meeting password and a message prompts you for one, contact the meeting organizer for the password.



NOTE: Meeting cards don't indicate if a meeting is password protected.

1. Do one of the following:
 - Manually dial in to a meeting.
 - Join a meeting from a meeting card.
2. Enter the meeting password and select **Join**.

If you enter an incorrect password, the password prompt displays again.

4 Sharing Content

To enhance the collaboration experience, you can share documents, graphics, videos, and blackboards or whiteboards with other participants.

You can share content with all members of a call or meeting using a computer or a certified device.

Sharing Content from a Computer or Device

You can share content from a computer or use applications to stream content from other devices.

You can use the following methods to share content:

- Polycom Content App, which wirelessly connects to the G7500 and Studio X series system
- Screen mirroring with an AirPlay- or Miracast-certified device
- Computer or device directly connected to the system through HDMI

The system allows up to four simultaneous content sources out of a call and three in a call (a source can include content shared from a device in the room or by a far-end participant).

For example, if you're in a call with three content sources and you share your desktop using the Content App, the oldest wireless or far-end content source in the session is replaced by your content. HDMI content, however, is never replaced.

 **IMPORTANT:** Before you share content, take precautions to protect your privacy. For example, disable your device's screen lock feature before you share your screen with meeting participants.

Polycom Content App

The Polycom Content App enables you to share content from a computer connected to a G7500 and Studio X series system over an IP network.

For information on using this application, see the [Polycom Content App User Guide](#).

Cast Content from an AirPlay- or a Miracast-Certified Device

You can share content from your Airplay- or Miracast-certified device and display it on the system.

1. Go to AirPlay or Miracast on your device.
2. From the list of available devices, select the name of your system.

3. Begin casting from your AirPlay- or Miracast-certified device.

For casting information for your device, refer to the product documentation.

4. If prompted, enter the security code shown on the **Home** screen.

Share Content Using an HDMI Connection

Share content from your device through an HDMI connection. This method doesn't require you to connect using a wireless service.

- Connect your device to the video system's HDMI input port.

Your HDMI content displays until you disconnect your device. If you restart the video system while your device is connected, the HDMI content is still there following the reboot.

Sharing Content on a Blackboard or Whiteboard

Blackboards and whiteboards provide blank canvases to write on so you can share your ideas and collaborate with others.



NOTE: Blackboard









Add a Blackboard or Whiteboard

You can create a blackboard or whiteboard at any time.



NOTE: If the active board has no annotations, you can't add a new board.

A limited number of blackboards or whiteboards are available. A prompt notifies you when you have reached the limit.

1. Do one of the following:
 - Out of a call: On the Home screen, select **Blackboard** .
 - In a call: Select **Menu**  > **Content** > **Blackboard** .
2. To add another board, do one of the following:
 - To add a blackboard: In the toolbar, select **Blackboard** .
 - To add a whiteboard: In the toolbar, long press **Blackboard**  and select **Whiteboard** .





NOTE: The default board type is whatever type you last selected.

Take a Snapshot of Your Content

You can take a picture of your current content. Then you can annotate the snapshot or download it using the Polycom Content App.

A limited number of snapshots are available. A prompt notifies you when you have reached the snapshot limit.

 **NOTE:** When you end the call or content sharing session, the system erases all snapshots and associated snapshot data.

- With a board or content on the screen, select **Snapshot** .

The system captures the content and displays it as *Snapshot-1*. The system names additional snapshots with successive numbers.

Delete Snapshots or Content

You can delete snapshots or content that you no longer need.

 **NOTE:** When you end the call or content sharing session, the system erases all snapshots and associated snapshot data.

1. Select a snapshot or piece of content in the content tray.
2. Select the red **X**.
3. Select **Delete**.

End a Content Session

By ending the content session, you stop showing and delete all content shared on your system.

1. During a content session, select **Menu**  > **End Session**.



A message displays a warning and a countdown timer.

2. Select **End Session**.

 **NOTE:** To keep content, select **Continue Session**.

End a Call with Blackboard or Whiteboard Content

If there's an open blackboard or whiteboard in your call (including drawings, markup, snapshots, or even a blank board), you can keep that content session going after hanging up. (Markup doesn't include highlights.)

1. In a call with blackboard or whiteboard content, select **Menu**  > **Hang Up** .

The call ends and the system prompts if you want to keep content.

2. Do one of the following:
 - Select **Yes, Keep Content**.
 - Select **No, End Session**.

If you keep content, the content session continues.

3. When you are ready to stop content, select **Menu**  > **End Session** > **End Session**.

5 Cameras

Camera controls are available in and out of calls.





You can control cameras, depending on the camera type, in the following ways:

Adjust an In-Room Camera

To enhance the view of meeting participants, make adjustments to the in-room camera.

If camera tracking is on, camera control is unavailable. Turn tracking off to access camera controls.

With the Studio X50 and Studio X30 systems, you can't pan or tilt the camera if it's zoomed all the way out.

1. Select **Menu**  > **Camera** .
2. Select **Control** .
3. Press **+** to zoom in or **-** to zoom out. Press the arrows to tilt up and down or to pan left to right.
4. To exit the control screen, select **Back** .





Adjust a Far-Site Camera

To enhance your view of the other meeting participants during a call, you can adjust the far-site camera.

If camera tracking is on, camera control is unavailable. Turn tracking off to access camera controls.







NOTE: Contact your administrator for help setting up this feature.

1. Select **Menu**  > **Camera** .
2. Select **Control** .
3. Select **Switch**  to select the **Far** camera.
4. Press **+** to zoom in or **-** to zoom out. Press the arrows to tilt up and down or to pan left to right.
5. To exit the control screen, select **Back** .

Turn Your Camera On or Off

Turn your camera on to show local video or turn your camera off to hide your local video.





 **NOTE:** Turning the camera on or off doesn't control the privacy shutter for the Studio E70 camera. When you turn the camera off, the Studio E70 camera stops sending video, but the privacy shutter remains open. See for more information on the privacy shutter behavior.

1. Go to **Menu**  > **Camera** .
2. Do one of the following:
 - Select **Camera On** .
 - Select **Camera Off** .

Turn Camera Tracking On or Off

When camera tracking is on, the camera automatically frames the group of people in the room or the current speaker (depending on your camera and how your system is configured).

 **NOTE:** If you mute your local microphone, the system disables speaker tracking.

1. Select **Menu**  > **Camera** .
2. Select **Tracking On**  or **Tracking Off** .

Using Camera Presets

If your camera supports presets, you can save up to 10 camera positions. Camera presets are stored camera positions that let you quickly point a camera at predefined locations in a room.

Near camera presets are available in or out of a call. Far camera presets are only available during a call. If enabled, you can use them to control the far-site camera.

When you save a preset, the preset saves the selected camera and the camera position.

 **NOTE:** If camera tracking is on, camera controls and presets are unavailable. Turn tracking off to access these features.

Save a Camera Preset from the Local Interface

Save the current camera position as a preset for later use.

Use saved presets to change the near camera position in or out of a call. Far camera presets are available only in a call.

1. Select **Menu** > **Camera**.
2. Select **Presets**.
3. Adjust the camera to the desired position.

4. Adjust the camera to the desired position.
5. Do one of the following:
 - On the screen, select an empty preset.
 - On the screen, long press the preset and choose **Save**.
 - On the remote control, press a number to select a preset.





Select a Preset

Using previously created camera presets, you can quickly move the camera to a desired position in a call.

1. Select **Menu > Camera**.
2. Select **Presets**.
3. Do one of the following:
 - Select the image of the preset you want.
 - On the screen, long press the image and choose **Select**.
 - On the remote control, press a number to select a preset.

Delete a Preset

You can delete a camera preset that you no longer need.

1. Select **Menu**  **> Camera**  .
2. Select **Presets**.
3. On the screen, long press the preset image you want to delete.
4. Select **Delete** .

Selecting the Primary Camera

In Poly Video Mode, if you have more than one camera attached to the system, you can select the primary camera in or out of a call.

Camera Priority

When you connect or disconnect a camera, camera priority determines the primary or active camera.

The system observes the following camera type priority:

1. Embedded camera
2. HDCI camera
3. USB camera
4. HDMI source set to display as people

Select the Primary Camera from the Local Interface

In Poly Video Mode, when you attach multiple cameras to the system, select the primary camera from the local interface.

1. Go to **Menu > Camera > Select Camera**.
2. Select a camera from the list.

The selected camera becomes the primary camera.

6 Using device mode

Poly Device Mode enables you to use the system's camera, speaker, microphone, and connected monitors from your computer.

Once you connect the system to your computer with a USB cable, you can control the video system's camera and audio features using your computer's third-party conferencing application.

For example, instead of using your computer's camera for Zoom Rooms calls, connect the Studio X30 and use its 4K camera to automatically follow the conversation in the room. You also gain a Poly echo-cancelling microphone and speaker technology during calls.



NOTE: The system doesn't support hot plugging cameras. To connect a camera to the system, power the system off, connect the camera, and restart the system.

Computer and cable requirements for Device Mode

Your computer and cables must meet the following requirements to use Device Mode.

Operating system requirements:

- Windows 10 1803 or later
- macOS 10.12 or later

USB cable requirements:

- A cable with at least one USB-C connection for the video system
- USB 2.0 or USB 3.0 cable (preferred to ensure connection reliability and video and audio quality)
- Self-powered USB booster extension cable for connections longer than 2 m (6.6 ft)



NOTE: Don't use a cable used for charging devices. A charging cable may not be capable of sending data.



HDMI cable requirements:

- An HDMI adapter is required if your computer doesn't have an HDMI port.

Access Device Mode

Use the system touchscreen or a TC10 or TC8 touch controller to start Device Mode.

 **NOTE:** Your administrator may configure your system to remain in Device Mode. If your system is already in Device Mode, the system monitor and TC10 or TC8 touch controller prompt you to connect a USB and HDMI cable to your computer.

- Do one of the following:
 - On a TC10, TC8, or touchscreen monitor, select **Device Mode** .
 - On a Trio phone, use the phone's navigation keys to highlight **Device Mode** , then press the **Select** button.

The *Device Mode* screen appears.

Use your system as a computer accessory

To use the video system as an external camera and audio accessory, set your system to Device Mode and connect your Windows or macOS computer with a USB cable.

If your system isn't already in Device Mode, access **Device Mode**. If your conferencing application uses echo cancellation, disable that feature.

You must use a cable with at least one USB-C connection for your video system. If you use a cable with only one USB-C connection, the USB-C end must connect to your video system for Device Mode to work properly.

 **NOTE:** Device Mode isn't available if your system administrator disables the system USB ports. If you need help with Device Mode or connecting a computer to your system, contact your administrator.

1. Connect a USB-C end of the USB cable to the video system's USB-C port, and connect the other end of the USB cable to your computer.

The system monitor and the TC10 or TC8 touch controller display a confirmation message.

2. **Optional:** To display your computer on the video system monitor, connect your computer using the system's HDMI input port.

Adjust the system audio and camera settings in Device Mode

In Device Mode, you can mute the system, adjust the volume, and adjust camera settings.

Access **Device Mode** and connect your computer to the system.

 **NOTE:** The controls on a connected Poly Trio phone don't work if the system is in Device Mode.

1. To mute the microphones, do one of the following:
 - In a conference application on your computer, select mute.
 - On the touch controller or any connected microphone, select **Mute** .
2. To adjust the volume, do one of the following:
 - On the touchscreen or TC10 or TC8, select **Volume** and adjust the volume slider.

- Adjust the volume from your computer using the computer or conference application settings.



NOTE: Ensure that you select the correct device when adjusting the volume. Changing the volume alone may not work. You must select the Poly video system as the audio device.

3. To configure camera settings:
 - a. From the right border of the TC10 or TC8 or the touchscreen, swipe left and select **Camera Settings**.
 - b. Select **Camera Control**.
 - Turn **Camera Tracking** on or off.
 - Select or set a **Preset**.
 - Press **+** to zoom in or **-** to zoom out.
 - Press the arrows to tilt up and down or to pan left to right.

Managing incoming calls when in Device Mode

Your video system rejects incoming calls in Device Mode.

Exit Device Mode and disconnect your computer

Any camera options you change on the video system with your USB-connected computer revert to their previous settings when you exit Device Mode.



NOTE: If the system is using Device Mode as the provider, **Exit** (⊗) isn't available.

- Do one of the following:
 - On the video system local interface or TC10 or TC8 touch controller, select **Exit** (⊗).
 - Unplug the cables connecting your computer and video system. After 2 minutes, you see the home screen (even if you haven't selected **Exit**).

7 Using the Poly Control App

The Poly Control App enables you to control a video system using a personal device, such as your mobile device or computer.

After you connect your personal device to the video system, you can place and manage calls, control camera settings, and interact with shared content.

The following features aren't available on the computer or mobile device controlling the system:

Control the System with the Poly Control App

You can use the Poly Control App on your computer or mobile device to control a video system.

You must be in the room with the video system and connect the mobile device to the same wireless network as the system to use the Poly Control App.

1. In a web browser on your computer or mobile device, enter `https://<systemIPaddress>/control`.

The website displays with the system's room name and IP address.

2. Select **Connect**.
3. On your computer or mobile device, enter the four-digit code that displays on the system monitor.

Your computer or mobile device displays a user interface similar to the video system. You can then use your personal device to control the system.

8 Settings

Before or during calls, you can adjust video and audio settings, including adjusting the volume and changing the video layout.



Video Adjustments

You can manage video and certain user interface settings.

Change the Participant Layout

During a call, you can change from the current layout to another layout better suited for the meeting. The layout frames include the near site and far site.

If you're sharing content on a single monitor, content displays in one of the frames.

1. In a call, go to **Menu**  > **Layouts** .
2. Select one of the following layouts:
 - **Equal:** All participants are the same size.
 - **Gallery:** Participants display at the top of the screen and the speaker displays in the main frame.
 - **Fullscreen:** The active speaker displays in full screen.



Audio Adjustments

You can control several audio settings on the system.

Mute Your Microphones

To prevent distractions for the speaker and meeting participants, you can mute your microphones.



You can mute your audio in or out of a call.

- Do one of the following:
 - On your remote control, press **Mute** .
 - On the screen, select **Menu**  > **Mute** .

A notification displays that the system muted your local microphones.

Unmute Your Microphones

When your audio is muted and you're ready to speak in a call, unmute your microphones.

- Do one of the following:
 - On your remote control, press **Mute**  .
 - On the screen, select **Menu**  > **Unmute**  .

Adjust the Volume

You can adjust the volume before or during a call.

1. Go to **Menu**  > **Volume**.
2. Do one of the following:
 - Use the volume slider on a touchscreen.
 - Press the + or - buttons on the remote control.
 - Press the left or right navigation buttons on the remote control (when the system displays volume control).

9 Troubleshooting

This section includes information related to troubleshooting issues with your system. You can also find information on pairing your remote, configuring your monitors, and where to find help tips.

Poly Device Mode

Use these topics to troubleshoot problems you may encounter using Device Mode.

Audio Levels are Too High or Low

In Device Mode, audio from the video system speakers is too loud or it's difficult to hear call participants.

In Device Mode, your conferencing application and laptop control the video system's audio. You may need to adjust those volume controls.

Follow these steps until you get the audio levels you want:

1. Adjust your conferencing application's volume.
2. Adjust your laptop's volume.

Conferencing Application Doesn't Use System Camera or Audio

Your conferencing application isn't using the video system's camera or audio in Device Mode.

Your conferencing application by default may choose the connected monitor speakers instead of, for example, the Studio X50 speakers.

- In your conferencing application, select the video system as your speaker, microphone, and camera device.

Can't Use System's Camera or Audio

Your conferencing application isn't using the video system's camera or audio in Device Mode. There could be a few reasons for these types of problems. For instance, your conferencing application by default may choose the connected monitor speakers instead of, for example, the Studio X50 speakers.

You may notice the following while using Device Mode:

- In your laptop's conferencing application, you can't select the video system as a camera or audio source.
- The video system's camera and audio seem unavailable.

- The video system's camera doesn't display live video.

Follow these steps until you fix your problem:

1. In your conferencing application, select the video system as your speaker, microphone, and camera device.
2. In your laptop settings, select the video system as your speaker, microphone, and camera device.
3. Exit and restart Device Mode.
4. Replug the USB cable.
5. Connect the cable to a different USB port on your laptop.
6. Try using a different USB cable.
7. Restart your laptop.

Improve Audio Quality

Audio quality during calls in Device Mode could be better. For example, people on the call notice interference or dropped words when you're speaking.

You may encounter these problems for the following reasons: additional USB connections, a bad cable, or audio processing settings.

Follow these steps until your audio quality improves:

1. Remove USB audio devices (such as a headset) connected to your laptop.
2. Connect your laptop and video system with a different USB cable.
3. If your conferencing application uses echo cancellation, disable that feature.
4. If you're playing a musical instrument, enable M-Mode in the system web interface.

Improve Laptop Screen Mirroring

When mirroring your laptop screen with an HDMI connection, the picture on the connected monitor isn't ideal.

The resolution on your laptop may need to be adjusted for the monitor connected to the Poly video system.

Follow these steps until screen mirroring quality improves:

1. Adjust your laptop's resolution settings.
2. Adjust your laptop's display settings so the screen duplicates on the monitor.

Can't Share Wireless Content

You try sharing content wirelessly (for example, from an AirPlay-certified device) but nothing happens.



If your video system is in Poly Device Mode, you can't share content wirelessly. You must exit Device Mode to share wireless content to the video system.

- Do one of the following:
 - On the video system local interface or TC8 device (if you have one), select **Exit**  .
 - Unplug the cables connecting your computer and video system. After two minutes, you see the video system home screen (even if you have not selected **Exit**).

View Content Help Tips



Content help tips provide information on how to stream content using HDMI, the Polycom Content App, or an Airplay- or a Miracast-certified device.

 **NOTE:** If you're already connected to a source for sharing content, the help tips don't display.

1. On the Home screen, select **Content**  .
The help screen opens.
2. Review the tips for your source type.
3. To go back to the previous screen, select **Back**  .

View Blackboard Help Tips

For help annotating on your blackboard or whiteboard, you can access information on how to use the annotation icons and touch gestures.

1. On the home screen, select **Blackboard**  .
2. On the toolbar, select **Help**  .
The help screen opens.
3. To close the screen, tap the screen or press **Back**  on your remote control.

10 Getting help

Poly is now a part of HP. The joining of Poly and HP will pave the way for us to create the hybrid work experiences of the future.

During the merge of our two organizations, information about Poly products will transition from the [Poly Support](#) site to the [HP® Support](#) site.

The [Poly Documentation Library](#) will continue to host the installation, configuration, and administration guides for Poly products in HTML and PDF format. In addition, the Poly Documentation Library will provide Poly customers with up-to-date status information about the transition of Poly content from the [Poly Support](#) site to the [HP® Support](#) site.

■ HP Inc. addresses

HP US
HP Inc.
1501 Page Mill Road
Palo Alto 94304, U.S.A.
650-857-1501

HP Germany
HP Deutschland GmbH
HP HQ-TRE
71025 Boeblingen, Germany

HP UK
HP Inc UK Ltd
Regulatory Enquiries, Earley West
300 Thames Valley Park Drive
Reading, RG6 1PT
United Kingdom

■ Document information

Model ID: Poly Bluetooth® Remote Control (model: P010), Poly IR Receiver (model: BW7650), Poly IR Remote (model: BW7600), Poly Microphone IP Adapter (model: P012), Poly IP Table Microphone (model: P013), Poly IP Ceiling Microphone (model: P014), Poly Studio X70 (model: P026), Poly Studio X50 (model: P017), Poly Studio X30 (model: P018), Poly Studio E70 (model: P025), Poly TC10 (model: P030), Poly TC8 (model: P020)

Document part number: 3725-00000-001A

Last update: June 2023

Email us at documentation.feedback@hp.com with queries or suggestions related to this document.