



Digital Projector User Manual

Portable Series | GV31

V 1.00

Product support

You are strongly recommended to upgrade the product to the latest firmware version and refer to the most up-to-date user manual to make best use of the product.

This document aims to provide the most updated and accurate information to customers, and thus all contents may be modified from time to time without prior notice. Please visit the website for the latest version of this document and other product information. Available files vary by model.

1. Make sure your computer is connected to the Internet.
2. Visit the local website from Support.BenQ.com. The website layout and content may vary by region/country. Look for the following regularly to get the most up-to-date information.
 - User manual and related document
 - Firmware and application
 - Frequently asked questions

Servicing

- If misuse or other accident occurs, contact qualified service personnel for servicing.
- Contact your place of purchase or visit the local website from Support.BenQ.com for more support.



Support.BenQ.com

Q&A index

Start with the topics you are interested in:

Setup

How do I set up the projector and turn it on?

- Choosing a location 21
- Powering on and initial setup 28

Image adjustment

How do I adjust the focus of the projected image?

- Adjusting the projection angle 33
- Fine-tuning the image clarity 34

How do I fit the projected image to the screen?

- Keystone 34

Usage

How do I project wirelessly?

- Wireless projection 39

How do I play music via the projector?

- Making your projector a wireless speaker 41

Maintenance and product support

What should I do if I don't plan to use the projector for a long time?

- Storing the projector 53

Table of Contents

Product support	2
Servicing	2
Q&A index.....	3
Safety instructions.....	7
Package contents.....	10
Introduction	11
Projector overview.....	11
Overview	11
I/O ports.....	13
Dimensions.....	14
Projector connections.....	15
Wireless connection (via ATV Dongle)	15
Wired connection (HDMI port)	15
Wired connection (USB-A port)	15
Wired connection (USB-C port)	15
Remote control (projector remote control only)	18
Remote control effective range.....	19
Setting to power on projector by remote control	19
Turning remote control backlight on/off	20
Installation	21
Choosing a location	21
Obtaining a preferred image size	23
Projection dimensions.....	23
Using the projector in an outdoor setting.....	24
Installing the ATV dongle	25
Power supply	27
Charging the battery	27
Getting started.....	28
Powering on and initial setup.....	28

Power LED indicator.....	29
Power menu options	30
Shutting down the projector	31
Upgrading your projector	32
Adjusting the projected image.....	33
Adjusting the projection angle	33
Fine-tuning the image clarity	34
Fitting the image to your screen.....	34
Keystone	34
Changing the input source	35
Watching streaming videos.....	36
ATV home screen.....	36
Choosing a proper picture mode for video streaming.....	37
Choosing a proper sound mode for video streaming.....	37
Customizing a sound mode	38
Projection.....	39
Wireless projection	39
Wired projection.....	39
Playing music with your projector	41
Making your projector a wireless speaker.....	41
Turning the screen off during music playback.....	42
Playing multimedia files from a USB flash drive.....	44
Power delivery to a USB-C device	45
USB-C power delivery notice.....	45
Menu navigation	46
Brightness	46
Picture Mode	47
Sound Mode	47
Picture	48
Sound	49

Focus	49
Installation	50
Power Mode	51
System	52
Maintenance	53
Care of the projector	53
Cleaning the lens.....	53
Storing the projector	53
Transporting the projector	54
Light source information	54
Extending LED life	54
Troubleshooting	55
Specifications	57
Projector specifications	57
Timing chart.....	59
Video timings	60
Supported file formats	61
Appendix	62
Working with a tripod (purchased separately)	62
Pairing with a new remote control.....	63
Copyright & disclaimer	64
Copyright	64
Disclaimer	64
Warranty.....	65
Statement regarding hyperlinks and third-party websites	65
BenQ ecoFACTS	66

Safety instructions

Your projector is designed and tested to meet the latest standards for safety of information technology equipment. However, to ensure safe use of this product, it is important that you follow the instructions mentioned in this manual and marked on the product.

1. Please read this user manual before you operate your projector.
Keep this manual in a safe place for future reference.

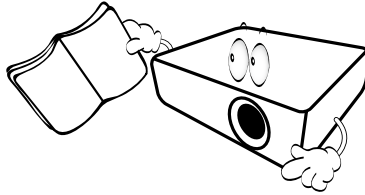

2. Always place the projector on a level, horizontal surface during operation.
 - Do not place the projector on an unstable cart, stand, or table as it may fall and be damaged.
 - Do not place inflammables near the projector.
Do not use if tilted at an angle of more than 10 degrees left to right, nor at angle of more than 15 degrees front to back.

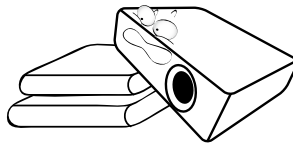

3. Do not store the projector on end vertically. Doing so may cause the projector to fall over, causing injury or resulting in damage.

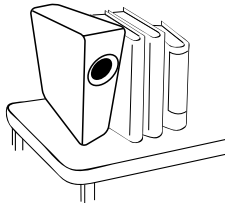

4. Do not place this projector in any of the following environments.
 - Space that is poorly ventilated or confined. Allow at least 50 cm clearance from walls and free flow of air around the projector.
 - Locations where temperatures may become excessively high, such as the inside of a car with all windows rolled up.
 - Locations where excessive humidity, dust, or cigarette smoke may

contaminate optical components, shorten the projector's lifespan and darken the screen.

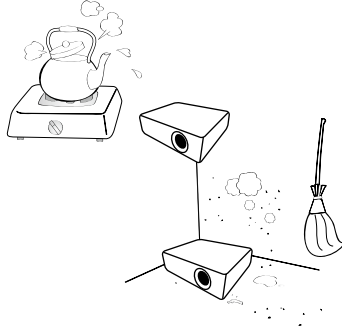

- Locations near fire alarms.
- Locations with an ambient temperature above 40°C /104°F
- Locations where the altitudes are higher than 2000 m (6562 feet).

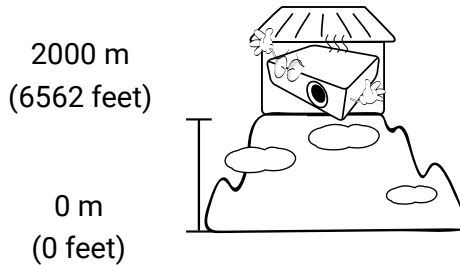

5. Do not block the vents holes while the projector is on (even in power-saving mode).
 - Do not cover the projector with any item.
 - Do not place the projector on a blanket, bedding or any other soft surface.

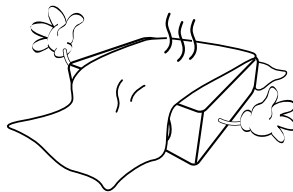

6. In areas where the mains power supply voltage may fluctuate by ± 10 volts, it is recommended that you connect the projector through a power stabilizer, surge protector or uninterruptible power supply (UPS) as appropriate to your situation.

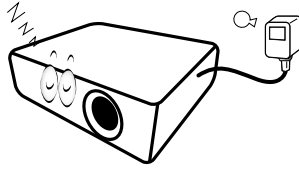

7. Do not step on the projector or place any objects upon it.

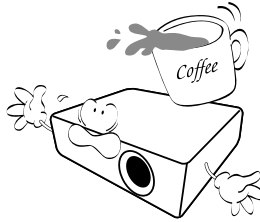

8. Do not place liquids near or on the projector. Liquids spilled into the projector will void your warranty. If the projector does become wet, disconnect it from the power point and call BenQ to have the projector repaired.

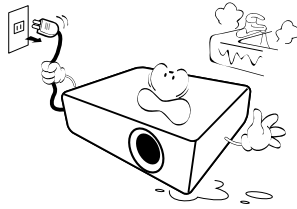

9. Do not look straight into the projector lens during operation. It may harm your sight.

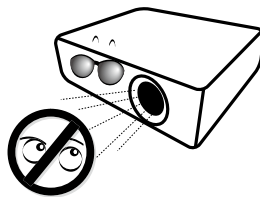

10. Do not operate the projector LED beyond the rated LED life. Excessive operation of LEDs beyond the rated life could cause LEDs to break on rare occasions.

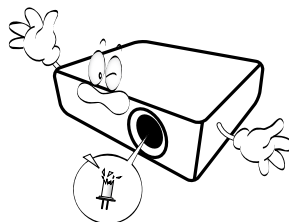

11. Do not attempt to disassemble this projector. There are dangerous high voltages inside which may cause death if you should come into contact with live parts.

Under no circumstances should you ever undo or remove any other covers. Refer servicing only to suitably qualified professional service personnel.

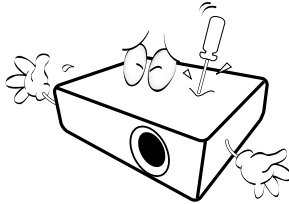

Warning

- Please keep the original packing for possible future shipment.
- If you need to pack your projector after use, adjust the projection lens to an appropriate position, put the lens cushion around the lens, and fit the lens cushion and projector cushion together to prevent damage during transportation.

12. When you think service or repair is required, take the projector only to a suitably qualified technician.

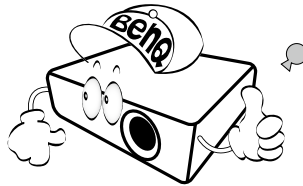

Moisture condensation

Never operate the projector immediately after moving it from a cold location to a hot location. When the projector is exposed to such a change in temperature, moisture may condense on the crucial internal parts. To prevent the projector from possible damage, do not use the projector for at least 2 hours when there is a sudden change in temperature.

Avoid volatile liquids

Do not use volatile liquids, such as insecticide or certain types of cleaner, near the projector. Do not have rubber or plastic products touching the projector for a long time. They will leave marks on the finish. If cleaning with a chemically treated cloth, be sure to follow the cleaning product's safety instructions.

Disposal

This product contains the following materials which are harmful to human bodies and environment.

- Lead, which is contained in solder.

To dispose of the product, consult your local environment authorities for regulations.

Note

- The illustrations and the images shown in this document are for your reference.
- The actual content may vary by the product supplied for your region.

Package contents

Carefully unpack and verify that you have all of the items shown below. Some of the items may not be available depending on your region of purchase. If any of these items are missing, please contact your place of purchase.

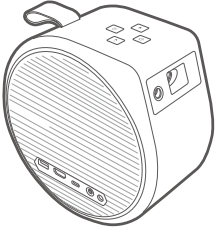

GV31



ATV dongle (QS02)

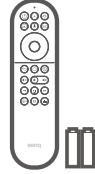

Projector's remote control
(With two AAA batteries)



Quick start guide

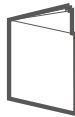

Regulatory statements



Warranty card
(Varies by region)

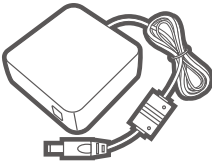

Power adapter



Power cord
(Varies by region)

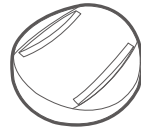

Base

Note

- LED life results will vary depending on environmental conditions and usage. Actual product's features and specifications are subject to change without notice.
- LED replacement is not user-serviceable. When it is needed, please contact the service center.
- Some of the accessories may vary from region to region.
- The warranty card is only supplied in some specific regions. Please consult your dealer for detailed information.
- Use original accessories to ensure compatibility.
- Power cord plug type may change based on regional requirements.

Introduction

Projector overview

Overview

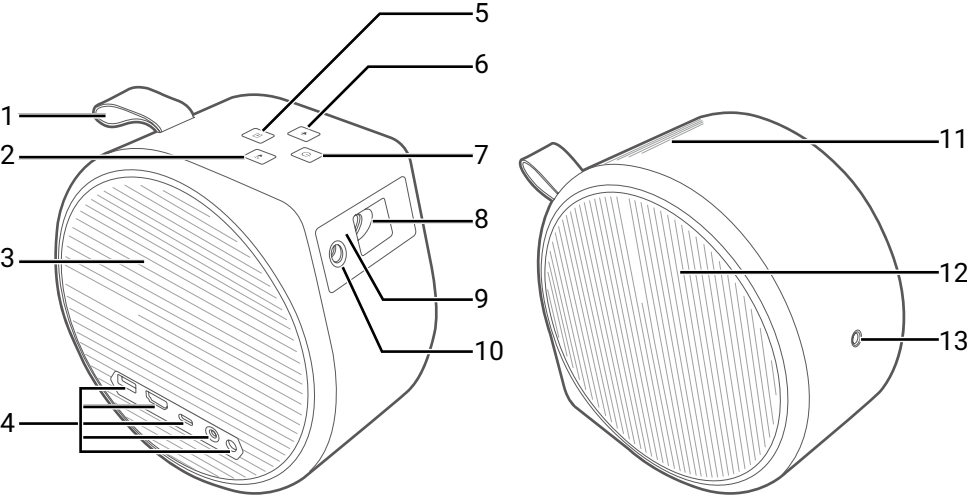

No.	Descriptions
1.	Strap
2.	Volume up button
3.	Left speaker and vent
4.	I/O ports <ul style="list-style-type: none">• See "I/O ports" on page 13 for details.• See "Projector connections" on page 15 for connections.
5.	Input source button
6.	Volume down button
7.	Power button and LED

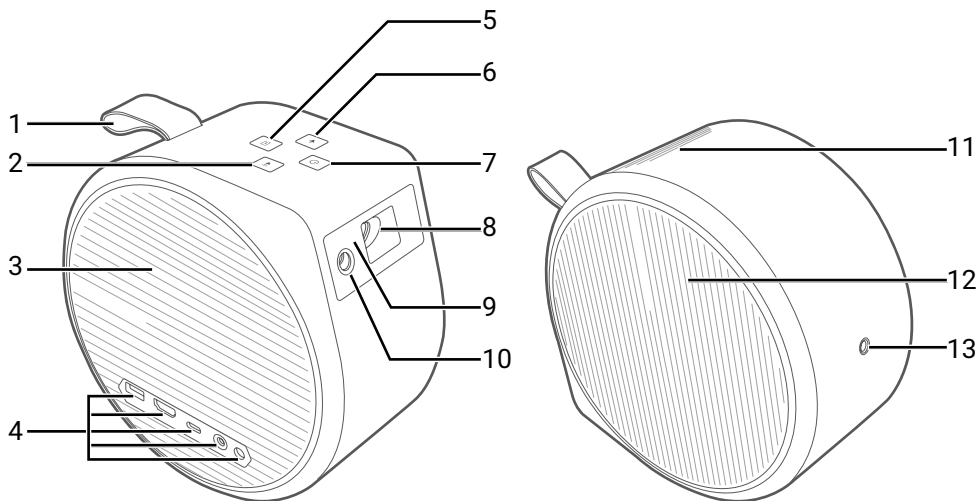

No.	Descriptions
8.	Projection lens
9.	IR sensor
10.	Auto focus camera
11.	Top speaker
12.	Right speaker and vent
13.	Tripod screw hole See " Working with a tripod (purchased separately) " on page 62 for details.

I/O ports

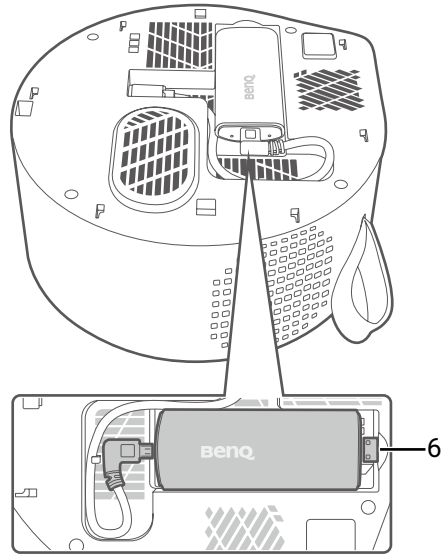
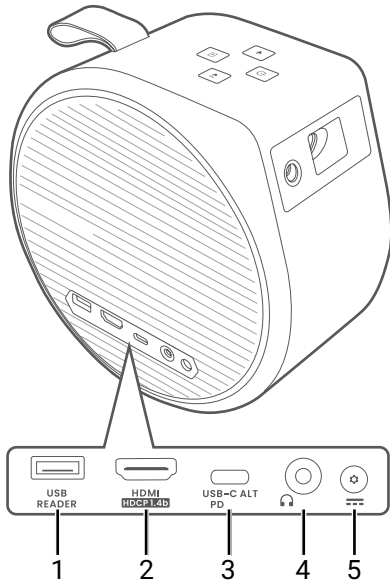

No.	Descriptions
1.	USB Type-A port See the following for details. <ul style="list-style-type: none">• "Playing multimedia files from a USB flash drive" on page 44• Power supply. See "Specifications" on page 57.
2.	HDMI port (Version 1.4b) See "Wired connection (HDMI port)" on page 15 for details.
3.	USB Type-C port See the following for details. <ul style="list-style-type: none">• "Power supply" on page 27• "Upgrading your projector" on page 32• "Wired projection" on page 39• "Playing multimedia files from a USB flash drive" on page 44• "Power delivery to a USB-C device" on page 45
4.	3.5" audio output jack
5.	Power adapter port
6.	Internal HDMI port (exclusively for QS02)

Dimensions

With Base: 131.3 (W) x 203.2 (H) x 191.4 (D) mm (5.2 x 8 x 7.5 in)

Without Base: 104 (W) x 191.4 (H) x 191.4 (D) mm (4.1 x 7.5 x 7.5 in)

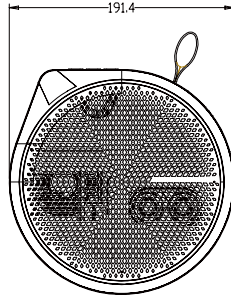
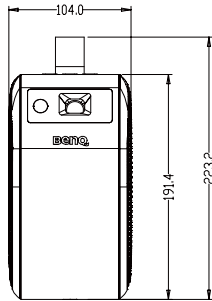
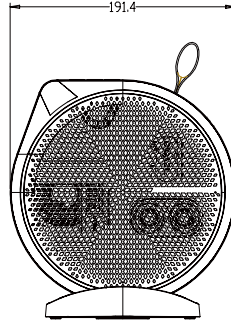
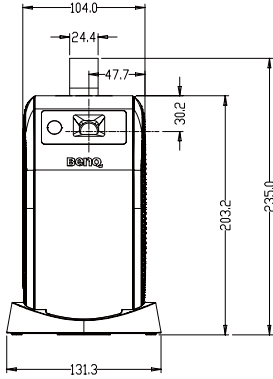

Projector connections

You can connect your device to the projector in various ways to project video content.

Wireless connection (via ATV Dongle)

- Smartphone, tablet, laptop/PC (see ["Wireless projection" on page 39](#))
- Bluetooth devices (speakers, headphone, mouse, etc.)

Before making any wireless connections, be sure to:

- Install the provided ATV dongle for wireless connection.
- Place the projector within range of the wireless AP you plan to connect it to.

Wired connection (HDMI port)

- A/V device
- Smartphone, tablet, laptop/PC

Wired connection (USB-A port)

- USB-A flash drive (see ["Playing multimedia files from a USB flash drive" on page 44](#))

Wired connection (USB-C port)

- Smartphone, tablet, laptop/PC (see ["Wired projection" on page 39](#))
- Power bank (see ["Power supply" on page 27](#) and ["Power delivery to a USB-C device" on page 45](#))
- USB-C flash drive (see ["Playing multimedia files from a USB flash drive" on page 44](#))

Before making any wired connections, be sure to use the correct cable for each source and that it is plugged in securely. Connection with USB-C cables/devices certified by USB-IF may increase compatibility.

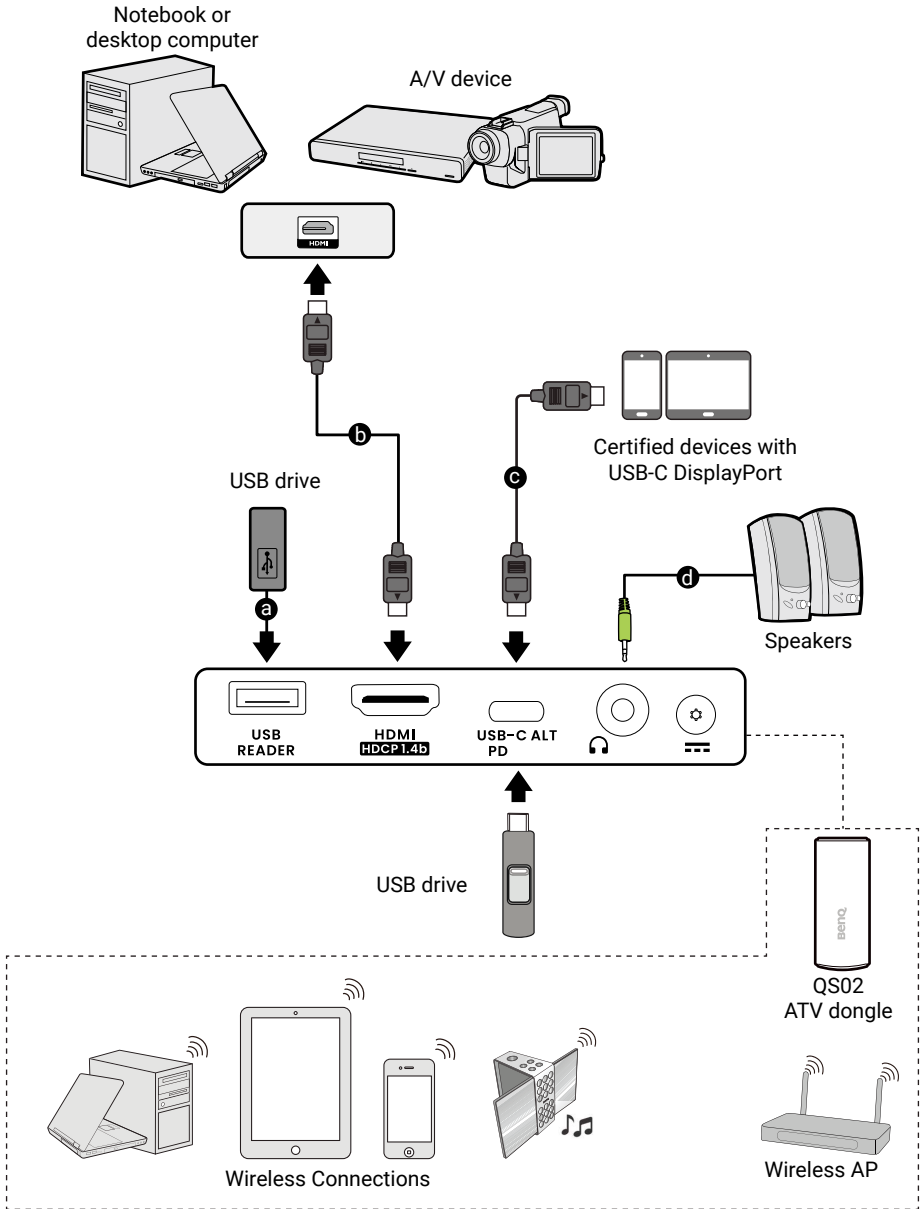

No.	Descriptions	No.	Descriptions
a.	USB flash drive for media reader	c.	Certified USB-C cable
b.	HDMI cable	d.	Audio cable

Note

- In the connections above, some cables may not be included with the projector (see "[Package contents](#)" on page 10). They are commercially available from electronics stores.
- The connection illustrations are for reference only.
- If the selected video image is not displayed after the projector is turned on and the correct video source has been selected, check that the video source device is turned on and operating correctly. Also check that the signal cables have been connected correctly.
- The built-in speaker(s) will be muted when the AUDIO OUT jack is connected.
- The illustration above is for reference only.

Remote control (projector remote control only)

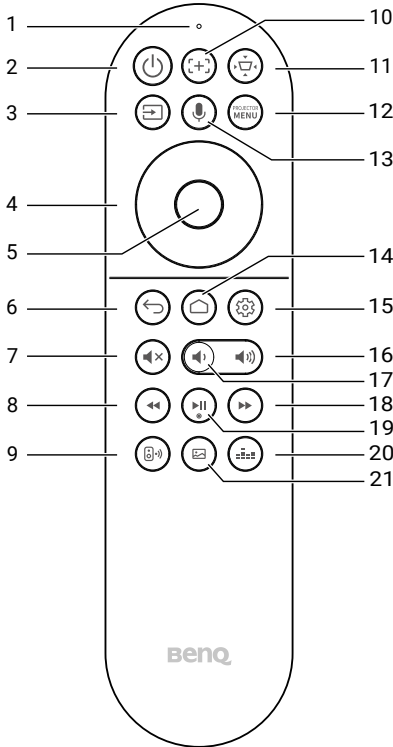

No.	Descriptions
1.	Microphone
2.	Power
3.	Source
4.	Arrow keys
5.	OK

No.	Descriptions
6.	Back
7.	Mute
8.	Rewind
9.	Wireless speaker mode
10.	Focus
11.	Geometry setting: Keystone
12.	PROJECTOR MENU Projector menu
13.	Voice Search
14.	Android TV home screen
15.	Android TV Settings
16.	Volume up
17.	Volume down
18.	Fast forward
19.	Play/Pause
20.	Sound mode
21.	Picture mode

Remote control effective range

The projector has one IR remote control sensor located at the front of the projector with a range of 8 meters (~26 feet) at an angle of 30 degrees (left and right) and 20 degrees (up and down). Prior to remote control pairing process during the setup wizard (see "[Powering on and initial setup](#)" on [page 28](#)), the remote control can only be used either by pointing it directly at the IR sensor or by reflecting the IR signal off of a wall/screen, making sure that there are no obstacles between the remote control and the IR sensor on the projector.

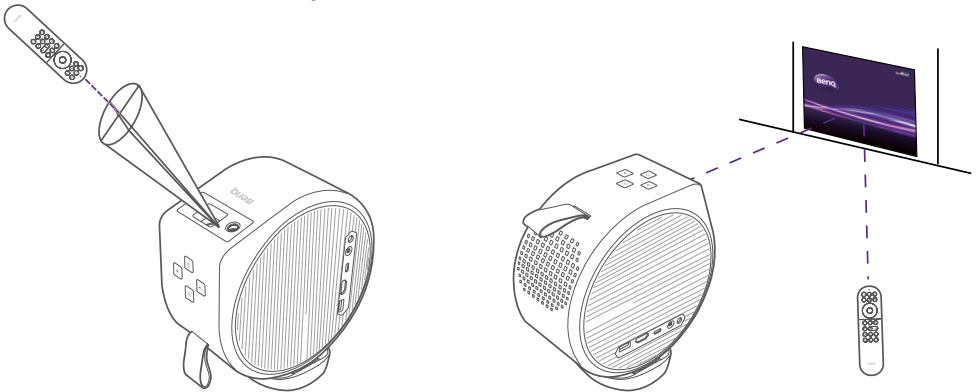

Once the remote control has been paired to the ATV dongle installed in the projector, you will be able to use it at any angle within a range of 8 meters (~26 feet).

Note



Voice search functionality on the remote control is only available after the remote control has been paired to the projector during the setup wizard process. See "[Powering on and initial setup](#)" on [page 28](#) for more details.

Setting to power on projector by remote control

Powering on the projector via the remote control is not enabled by default. To enable it, press the **PROJECTOR MENU** > **System** > **Use remote control to power on**. Once enabled, the projector scans for remote control signals when it is powered off and may drain battery power gradually.

Turning remote control backlight on/off

With the remote control backlight, you can see the buttons when they are pressed in the dark.

Press and hold the Mute button  and Volume up button  on the remote control to turn the backlight function on/off. To save battery power, you can turn off the backlight.

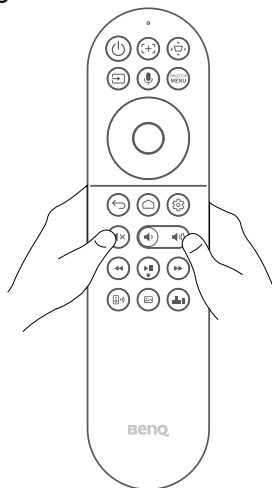

Installation

Choosing a location

Before choosing an installation location for your projector, take the following factors into consideration:

- Size and position of your screen
- Electrical outlet location
- Location and distance between the projector and the rest of your equipment
- Location and distance between the projector and the wireless access point

You can install your projector in the following ways:

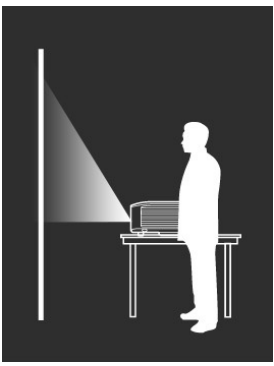
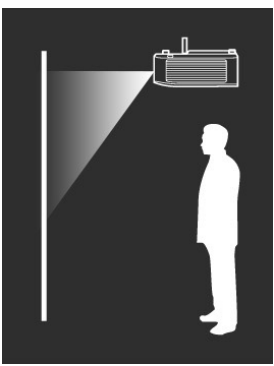
<ul style="list-style-type: none">• Front Table Select this location with the projector placed near the floor in front of the screen. This is the most common way to position the projector for quick setup and portability. Turn on the projector and select the following settings in the projector's settings menu. See "Installation" on page 50 for more details: Installation > Projector Position > Front Table	 A white silhouette of a person stands on the right, looking at a vertical screen on the left. A projector sits on a table in front of the screen, projecting a beam of light onto the screen.
<ul style="list-style-type: none">• Front Ceiling Select this location with the projector elevated near the ceiling in front of the screen. Turn on the projector and select the following settings in the projector's settings menu. See "Installation" on page 50 for more details: Installation > Projector Position > Front Ceiling <p>Note The projector does not feature ceiling mount components/equipment. When choosing to use a ceiling location, you must place it on an elevated and even shelf purchased separately. Make sure the shelf is stable enough to support the projector's weight. Secure the shelf properly and keep the projector from falling.</p>	 A white silhouette of a person stands on the right, looking at a vertical screen on the left. A projector is mounted on a shelf near the ceiling, projecting a beam of light onto the screen.

- **Rear Table**

Select this location with the projector placed near the floor behind the screen.

Turn on the projector and select the following settings in the projector's settings menu. See "[Installation](#)" on page 50 for more details:

Installation > Projector Position > Rear Table

Note

A special rear projection screen is required.

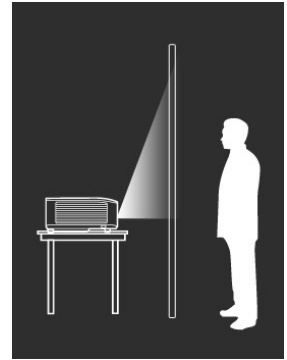

- **Rear Ceiling**

Select this location with the projector elevated from the ceiling behind the screen.

Turn on the projector and select the following settings in the projector's settings menu. See "[Installation](#)" on page 50 for more details:

Installation > Projector Position > Rear Ceiling

Note

- A special rear projection screen is required.
- The projector does not feature ceiling mount components/equipment. When choosing to use a ceiling location, you must place it on an elevated and even shelf purchased separately. Make sure the shelf is stable enough to support the projector's weight. Secure the shelf properly and keep the projector from falling.

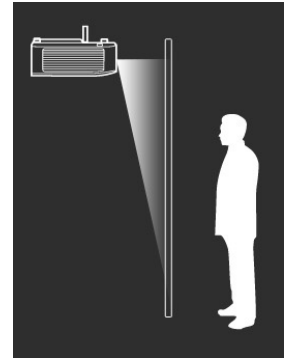

Obtaining a preferred image size

The distance from the projector lens to the screen, the zoom setting, and the video format each factors in the projected image size.

Projection dimensions

The screen aspect ratio is 16:9 and the projected picture is in a 16:9 aspect ratio.

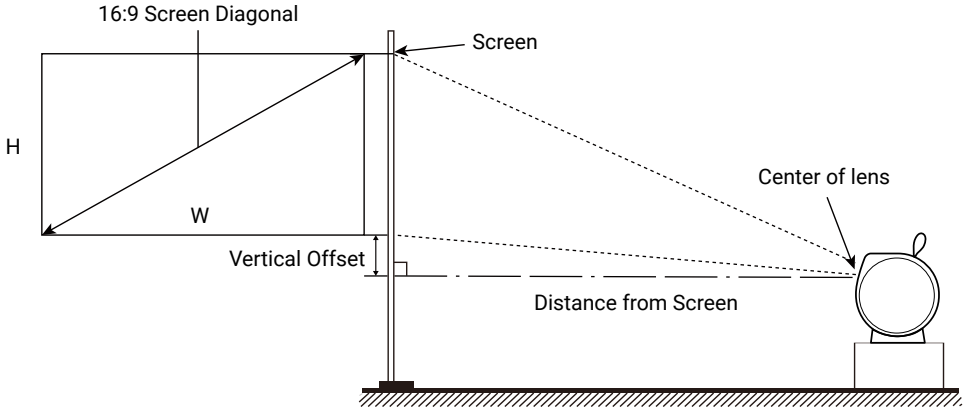

Screen size		W (mm)	H (mm)	Distance from screen (mm)
Inch	mm			
30	762	664	374	797
40	1016	886	498	1063
50	1270	1107	623	1328
60	1524	1328	747	1594
70	1778	1550	872	1860
80	2032	1771	996	2125
90	2286	1992	1121	2391
100	2540	2214	1245	2657
110	2794	2435	1370	2922
120	3048	2657	1494	3188

For example, if you are using a 100-inch screen, the recommended projection distance is 2657 mm.

If your measured projection distance is 2391 mm, the projected screen size is 90-inch.

Note

- All measurements are approximate and may vary from the actual sizes.
- To optimize your projection quality, we suggest referring to the values listed in the non-gray rows for projection.
- BenQ recommends that if you intend to permanently install the projector, you should physically test the projection size and distance using the actual projector in situ before you permanently install it, so as to make allowance for this projector's optical characteristics. This will help you determine the exact mounting position so that it best suits your installation location.

Using the projector in an outdoor setting

The projector is designed mainly for indoor use but its portable design also allows it to support occasional outdoor use. When using the projector outdoors, the following items are suggested to enhance the viewing experience:

- Install the projector on a tripod if there is no flat surface to place the projector. See "[Working with a tripod \(purchased separately\)](#)" on page 62 for more details.
- Set the picture mode to the most suitable setting (e.g. **Bright** for a brightly lit environment). See "[Picture Mode](#)" on page 47 for more details.

Installing the ATV dongle

1. Find the provided ATV dongle in the packaging.

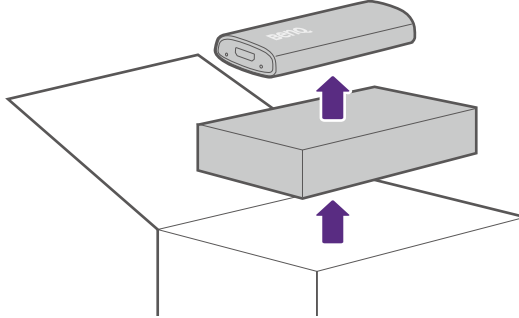

2. Place the projector on a flat and stable surface covered by a protective sheet with its right speaker facing up. Make sure the rear speaker is facing you with the strap on the right.
3. Using the thumbs of both hands push the edge of the right speaker cover so that it slides forwards and then remove the cover from the projector.

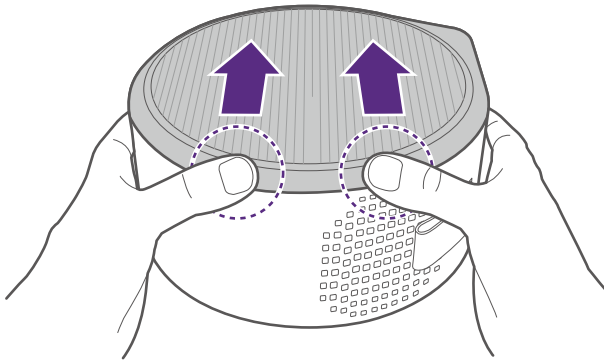

4. Peel off the adhesive sponge covering the micro USB power cable compartment.
5. Orient the ATV dongle so that the BenQ logo faces up, then connect the micro USB power cable to the port at the rear side of the dongle and then push the dongle into the HDMI connector on the projector until you hear a click.

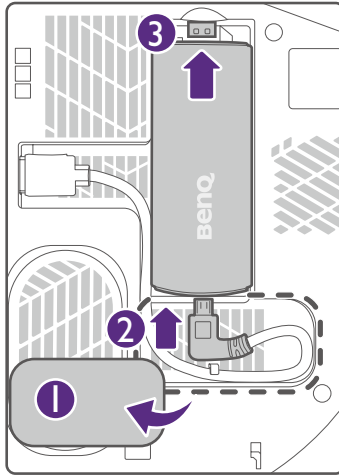

6. Align the right speaker cover over the projector so that the hooks on the cover line up with the corresponding openings on the projector, and then re-install the top cover onto the projector.

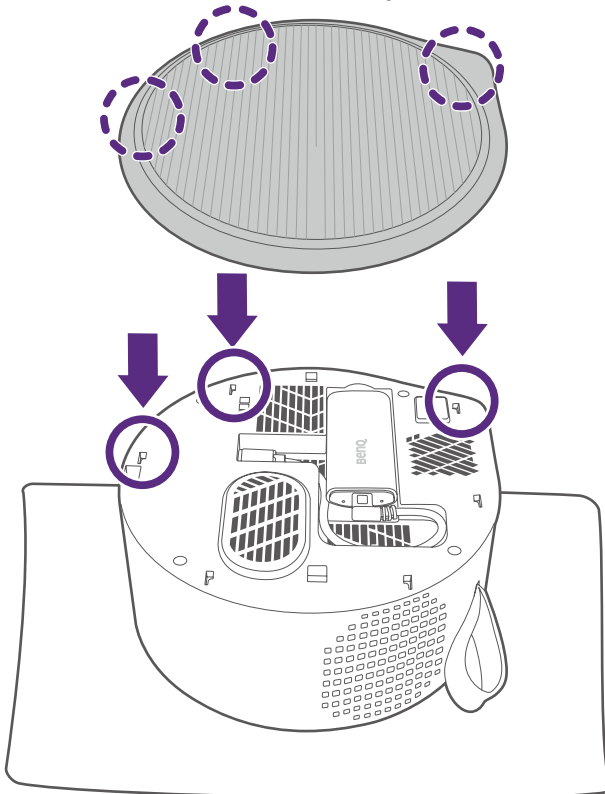

Power supply

Supply power to your projector by one of the following methods.

- (Recommended) Via the provided power adapter and power cord. The **Power Mode** is switched to **Normal** or the previous mode you set.
- Via a power bank or power adapter with USB-C connector or USB-C cable that are certified by USB-IF. See PD in information in "[Specifications](#)" on page 57 for details. The **Power Mode** is switched to **Normal** or the previous mode you set.
- Via the built-in battery after it is fully charged. The projector's **Power Mode** is switched to **Low Power Consumption** automatically.

Note

- The USB-C port is able to provide power to connected devices. See "[Power delivery to a USB-C device](#)" on page 45 for more information.
- The USB-A port is able to provide power to connected devices. See "[Specifications](#)" on page 57.
- Please only use the supplied power adapter to avoid possible dangers such as electric shock and fire.

Charging the battery

1. Make sure the appropriate plug has been properly assembled, and then connect the adapter to the power adapter port.
2. Connect the power cord to a power outlet.

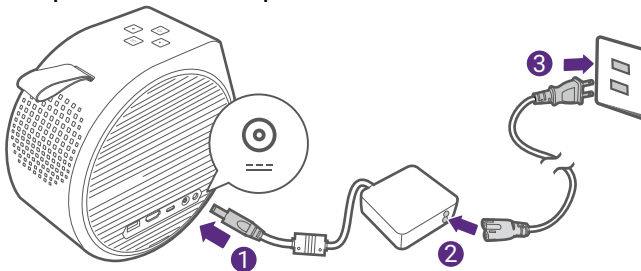

The power LED indicator will illuminate according to its charge status, for a full charge wait until the indicator lights up solid green (see "[Power LED indicator](#)" on page 29 for more information on LED behavior). It takes about 3 hours.

Getting started

Powering on and initial setup

1. Choose a preferred location and image size as instructed in "[Choosing a location](#)" on page 21. Make sure the ATV dongle has been installed. See "[Installing the ATV dongle](#)" on page 25 for more details.
2. Install the remote control's batteries.
Before you can begin to use the remote control, you must install the supplied batteries into the remote control.
 - Slide the battery cover outwards.
 - Insert the batteries in the orientation shown below.
 - Slide the battery cover back onto the remote control.

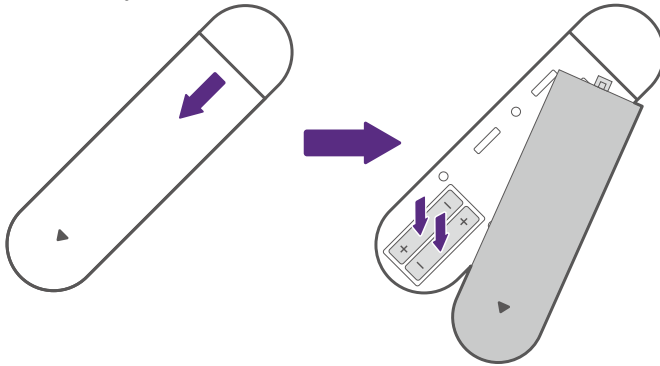

Note

Avoid leaving the remote control and batteries in an excessively hot or humid environment like the kitchen, bathroom, sauna, sunroom or in a closed car.

3. Connect power to the projector. If you are starting up the projector for the first time, charge the battery or supply power to the projector until the power LED lights up in green. See "[Charging the battery](#)" on page 27 for more information.

Press and hold the power button  on the projector for 3 seconds. The power LED will flash green slowly.

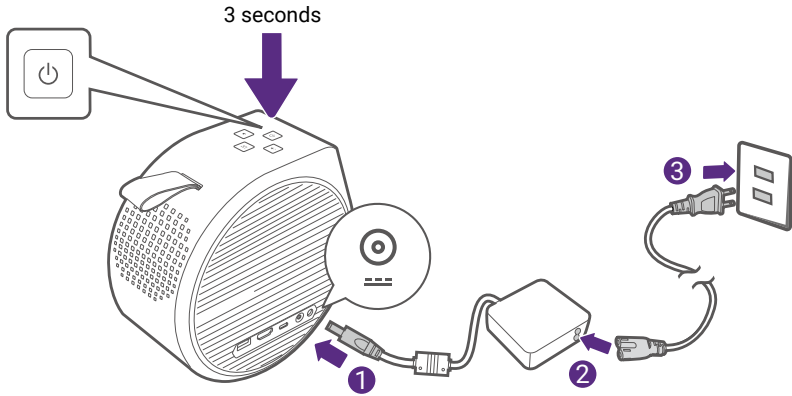

Note

- When supplying power directly to the projector via the supplied power adapter please use the supplied power cable to avoid possible dangers such as electric shock and fire.
 - Prior to pairing the remote control to your projector you must ensure that your remote control is in range of the projector's IR sensor. See "[Remote control effective range](#)" on page 19 for more details.
 - Powering on via the remote control is not enabled by default. To enable it, go to **System > Use remote control to power on**.
 - Powering on via the remote control will not work if you have not completed the setup wizard procedure or if the projector's battery level is below 5%.
4. Power on the projector and follow the on-screen instructions to complete the initial setup. When you're prompted to set up your remote, select "**Not now**" to proceed. You can refer to the QS02 user manual from Support.BenQ.com for more information.
 5. Check if an updated firmware is available for your product. Refer to "[Upgrading your projector](#)" on page 32.
 6. Go for a preferred scenario.
 - "[Watching streaming videos](#)" on page 36
 - "[Projection](#)" on page 39
 - "[Playing music with your projector](#)" on page 41

Power LED indicator

Scenario	LED status	Power status
Turning on/off	Flashing green	Turning on/off properly
	Flashing red	Low battery (below 5%)
Charging with adapter	Solid green	Fully charged
	Solid red	Charging

Scenario	LED status	Power status
Battery mode	Solid/Breathing green	Battery capacity: 60% - 100%
• Power on: Solid	Solid/Breathing red	Battery capacity: 21% - 59%
• Power saving/Audio only: Breathing	Flashing/ Breathing red	Battery capacity: < 20%

Power menu options

Press the  button on the remote control or projector to bring up the power menu.

Item	Description
Power Off	Sets to power off the projector.
Audio-Only Mode	Sets to turns off the screen while the music playback continues. See "Turning the screen off during music playback" on page 42 for more information.
Power Saving	Sets the projector and the ATV dongle to power saving mode when they are not in use. To disable Power Saving mode, press the  button.

Shutting down the projector

Press and hold the power button  on the projector for over 3 seconds and the projector will shut down directly.

The power LED will flash green. The fans may continue to run in order to cool the system.

If the projector will not be used for an extended period, unplug the power cable from the power outlet and remove the batteries from the remote control.

Note

Short pressing the power button on the projector or remote control will trigger a shutdown confirmation box. Under this condition, press the power button again to shut down the projector.

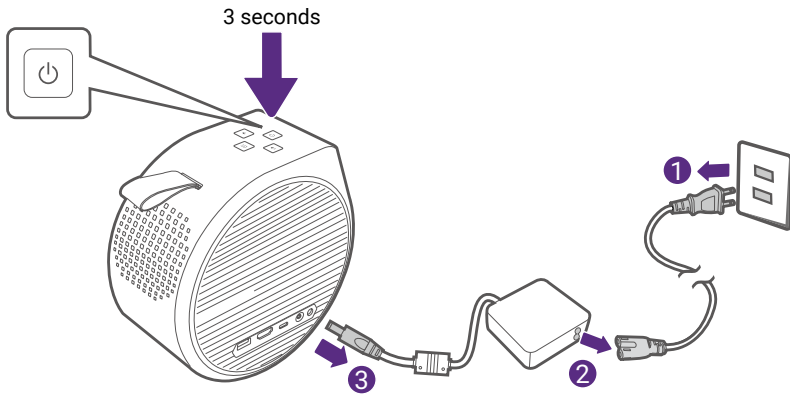

Upgrading your projector

It is suggested that you update the projector with the latest version of the firmware to optimize the user experience.

How-to Video



[Firmware Upgrade](#)

1. Visit Support.BenQ.com and download the new firmware files (if available) of your projector. Save the firmware files to a USB flash drive in FAT32 disk format. You should download the latest user manual for reference as well.
2. Keep stable power supply to the projector via power adapter. Do not power off the projector.
3. Connect the USB flash drive to the USB-C port.
4. Go to **System > System Update > USB Update** on your projector to start the upgrade. Wait until you are instructed to complete the initial setup. The upgrade is complete.

Note

Check if there are updated firmware files and user manual of QS02 ATV dongle from Support.BenQ.com. Find out the updates from the upgrade notice. If a new firmware version is available, you are recommended to upgrade the dongle for best performance.

Adjusting the projected image

Adjusting the projection angle

The projector features a base that holds the projector and allows you to adjust the projection angle.

Place the projector properly on the base until it clicks, and rotate the projector to adjust the projection angle.

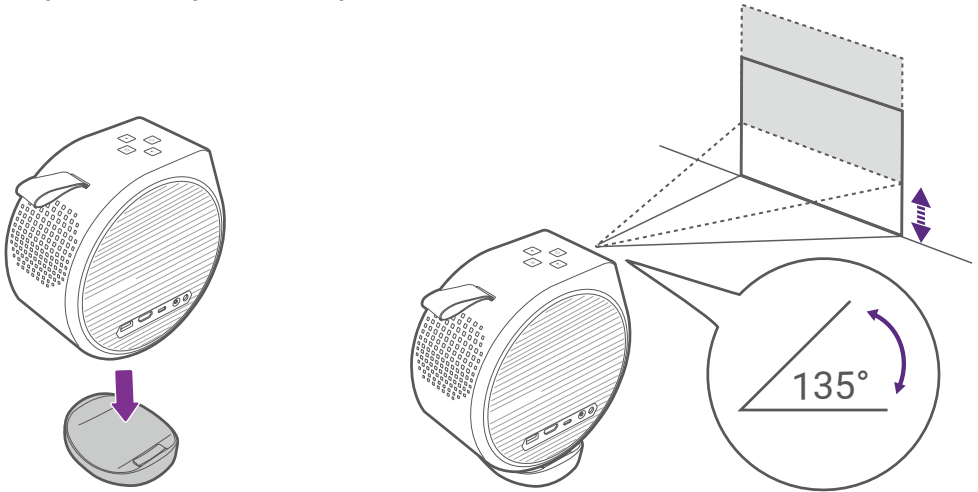

Note

- The maximum angle of adjustment is 135 degrees.
- If the screen and the projector are not perpendicular to each other, the projected image becomes trapezoidal. To correct this, see "[Keystone](#)" on page 34 for details.
- When the projector is on, DO NOT place down the projector with its left or right vents facing down as this will block the vents.

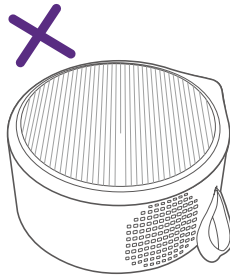

Fine-tuning the image clarity

To sharpen the picture, adjust the focus.

- **Real-time focus adjustment:** You may allow the projector to automatically focus the image in real-time via the settings menu by configuring **Focus > Real Time Adjustment** to **On**. When the projector is moved or the projection distance is changed, the function will be performed automatically. The effective distance from the projection lens to the screen is 3.2 meters. See "[Focus](#)" on page 49 for more information.
- **Auto focus:** Press the focus button **[+]** on the remote control and the projector will automatically focus the image. When the focus is completed, press **←** / **PROJECTOR MENU** to leave.

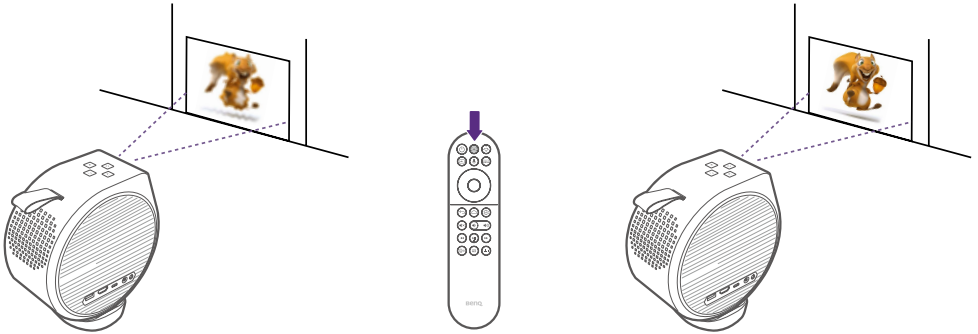

- **Manual focus:** You may also manually focus the image by either pressing the focus button **[+]** on the remote control and pressing the left **◀** or right **▶** buttons on the remote control while the focus guide is still on the screen, or by using **Focus > Manual Focus** in the settings menu. See "[Focus](#)" on page 49 for more information.

Note

Do not look into the lens while the light is on. The strong light from the lens may cause damage to your eyes.

Fitting the image to your screen



Keystone

The keystone effect refers to the situation where the projected image is noticeably wider at the top / bottom / left / right. It occurs when the projector is not perpendicular to the screen. The screen automatically

performs keystone correction as the projector moves.

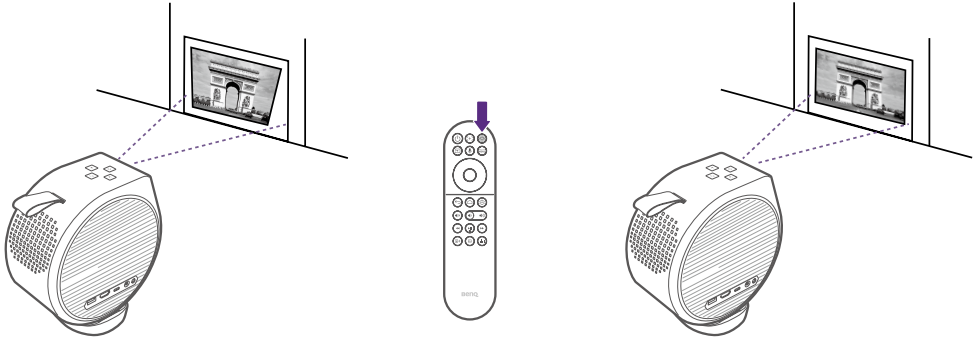
- Auto Vertical Keystone: Available from **Installation > Auto Vertical Keystone** in the settings menu. When the projector is moved or the projection angle is changed, the function will be performed automatically.
- Manual Keystone: Available by pressing the  button on the remote control or from **Installation > Vertical Keystone Correction**. Simply follow the on-screen instructions to make adjustments.



When you are done making the adjustments, press  /  to save your changes and return to the previous menu.

Changing the input source

By default, the projector will enter the **Android TV** interface any time it is powered on. Once powered on, when a device is connected to one of its input ports the projector will automatically switch over to that input source. To switch between input sources and **Android TV**, press the source button  on the remote control and select the desired input source from the source menu.

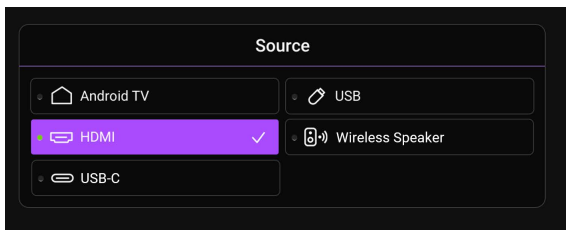

You can also press the home button  on the remote control to return to the **Android TV** home screen at any time.

Watching streaming videos

Make sure the ATV dongle (QS02) has been installed and connected to a wireless network properly. Android TV is the projector's operating system that allows you to project videos wirelessly and use streaming apps.

Note

For the ATV dongle (QS02) user manual, visit Support.BenQ.com.

ATV home screen

Upon initial startup or when the input source is set to ATV the projector will display the **Android TV** interface. If the projector is projecting from a source, you can return to **Android TV** by pressing the  key on your remote control or by selecting ATV in the input source menu.

The **Android TV** home screen features following items:

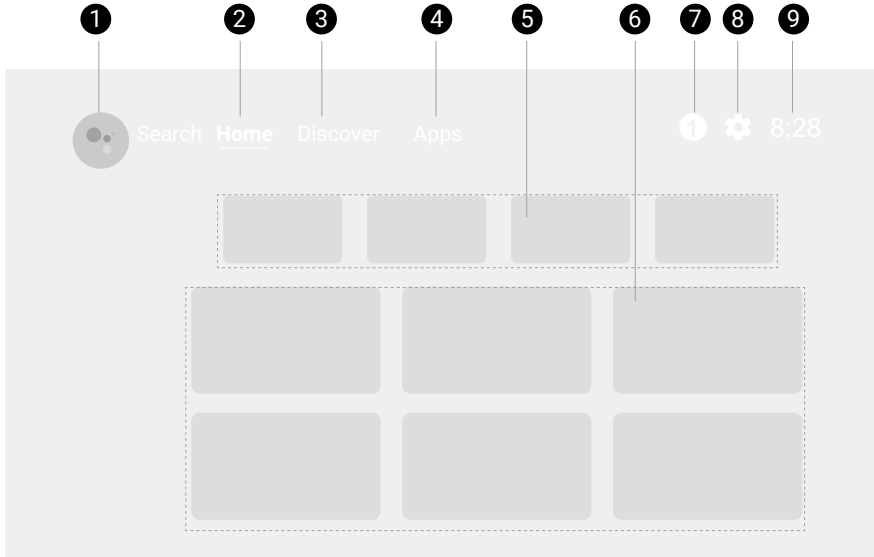

Note

Actual screen may vary based on your **Android TV** version.

No.	Item	Description
①	Google Assistant	Press the Google Assistant button on your remote control to talk to Google.
②	Home	Access to Android TV Home screen.
③	Discover	Access to personalized recommendations.

No.	Item	Description
4	Apps	Access to all the installed apps and Google Play.
5	Recommended apps/My favorites	<ul style="list-style-type: none"> • Access to the recommended apps or video on demand services. • Access to the apps that have been added to favorites by the Bookmark key.
6	Recommended content	Access to the content recommended by the specified channel/streaming service.
7	Notification	Access to notifications.
8	Settings	Access to Android settings menus.
9	System time	Displays the time.



Choosing a proper picture mode for video streaming

You are provided with a variety of picture modes for different scenarios in **Picture Mode**. Press the  button on the remote control for options. Usually **Cinema** and **Living Room** are recommended for watching movies. See "[Picture Mode](#)" on [page 47](#) for more information.

Choosing a proper sound mode for video streaming

In general, you can select a sound mode from **Sound Mode** to suit your scenario. Press the  button on the remote control for options. As **Cinema Extra Bass** is recommended for movie watching, more options are provided to enhance your cinematic experience. See "[Sound Mode](#)" on [page 47](#) for more information.

Customizing a sound mode

1. Go to **Sound > User**.
2. Adjust the frequency as desired.
3. Press  on the remote control to save the changes and exit. To apply the customized sound mode, press the  button on the remote control and select **User**.

Note

Press **Sound > Reset Audio Settings** to reset audio settings to factory defaults.

Projection

Wireless projection

Wireless projection is available only after the supplied ATV dongle (QS02) is installed, and the projector and your device are connected to the same wireless network. Refer to the QS02 user manual from [Support.BenQ.com](https://support.benq.com) or scan the following QR code for instructions on how to perform wireless projection.

How-to video



[Wireless projection](#)

Wired projection

Using an HDMI or certified USB-C 3.0 cable you can connect a device that is equipped with HDMI or DisplayPort capabilities to broadcast videos and images on the projector.

Note

Not all devices with a USB-C port have DisplayPort functionality. Check your device's documentation for clarification.

To connect a device with HDMI or USB-C with DisplayPort:

1. Connect the device to the HDMI or USB-C port on the projector with a certified cable. A pop-up notification will appear indicating that a device is connected.
2. Confirm whether you want to project video from the device. The video from the device will be displayed once the signal from the device is detected.

Note

If no signal is detected or the signal is interrupted, a message will appear, check the cable connection again.

3. Use the source menu or press the home button  to exit and go back to the **Android TV** home screen.
4. If the device remains connected and you want to project its video

again, press the source button , and then select the corresponding port in the source menu.

Note

- Some computers feature HDMI ports that do not transmit audio, in such cases a separate audio cable must be connected to the projector.
- Some laptops do not turn on their external video ports when connected to a projector. Usually a key combination like Fn + F3 or CRT/LCD key turns the external display on/off. Locate a function key labeled CRT/LCD or a function key with a monitor symbol on the laptop. Press Fn and the labeled function key simultaneously. Refer to your laptop's documentation to discover your laptop's key combination.



Tip

Your projector features video/audio transfer and power delivery from the USB-C port. With this feature, you can charge your gaming console (with USB-C video output) directly during gaming without any other docking. See ["Power delivery to a USB-C device" on page 45](#) for details.

Playing music with your projector

With the built-in speakers, you can enjoy music playback via the projector without a projection screen. The projector can work as an ordinary speaker or a wireless speaker.

Making your projector a wireless speaker

1. Make sure the ATV dongle is installed properly (see "[Installing the ATV dongle](#)" on page 25).
2. Power on the projector (see "[Powering on and initial setup](#)" on page 28).
3. Press the wireless speaker mode  button on the remote control or press the input source  button > **Wireless Speaker**. The projector will stop projecting and switch over to wireless speaker mode.
4. Connect your mobile device and the projector (with the QS02 ATV dongle installed) to the same wireless network.
5. Launch the music app on your mobile device and use the casting function through Chromecast. Find QS02 as the casting device to enjoy music streaming.

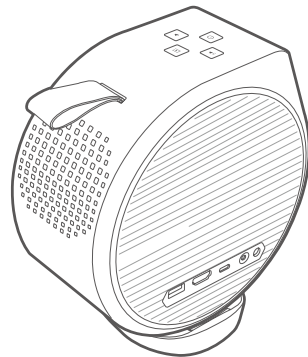

Turning the screen off during music playback

You can enjoy music playback via the projector without a projection screen.

Press the  button on the remote control or projector, and select the **Audio-Only Mode** to switch the projector to audio-only mode. The screen is turned off while the music playback continues.

To stop the playback or to perform other operations, press any key on the remote control to bring the projection screen back.

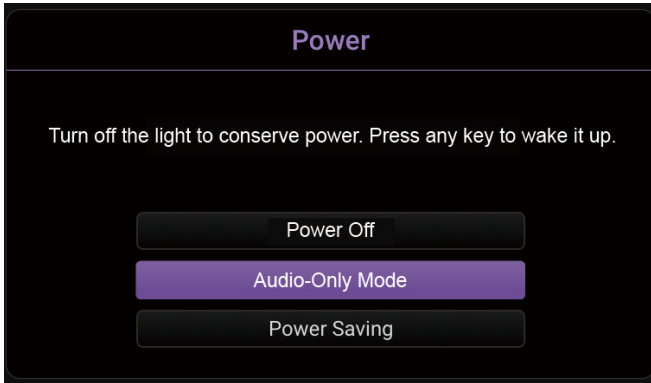

Connecting the projector to an external Bluetooth speaker / headphone

Available only when the input source is ATV.

1. Make sure the ATV dongle is installed properly (see ["Installing the ATV dongle" on page 25](#)).
2. Power on the projector (see ["Powering on and initial setup" on page 28](#)).
3. Press the  button on the remote control.
4. Select **Remotes & Accessories**.
5. Select **Add Accessory**.
6. Activate Bluetooth-pairing mode on the speaker or headphones.
7. Select the speaker or headphones from the device list shown on screen.
8. Select **Pair**.

When the projector and speaker or headphones have successfully

connected, the device will be labelled as connected in the **Network & Internet**. You can now output the audio from the ATV to the speaker or headphone.

Note

- This function is available only when the input source is set to ATV. Even when the projector is switched to other input sources, such as HDMI, as ATV is still running in the background, it will continue to transmit audio from ATV to the connected Bluetooth speaker or headphones.
- The projector does not support automatic re-connections with previously paired devices. In order to re-connect to a paired device or connect to another device, repeat the steps above.

Playing multimedia files from a USB flash drive

To play media files stored on a USB flash drive, you must make connections and settings properly.

1. Make sure the ATV dongle is installed properly (see ["Installing the ATV dongle" on page 25](#)).
2. Connect your USB flash drive to the USB-A or USB-C port of the projector.
3. Press the source button  on the remote control and select **USB** in the source menu.
4. Follow the on-screen instructions. Click **Apps** from the ATV home screen.

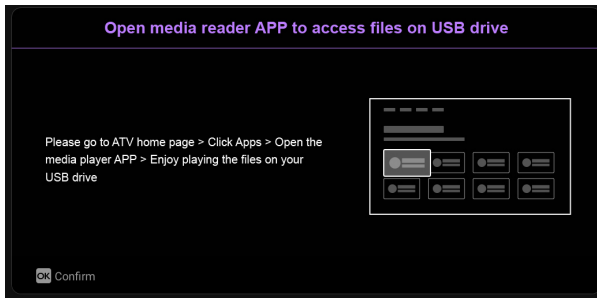

5. Launch a media reader app to access the multimedia files stored on your USB flash drive. Supported file formats for playback may vary by app.

Power delivery to a USB-C device

Available only when the projector is supplied power via the included power adapter.

With the power delivery function, your projector is able to supply power to a connected USB-C device certified by USB-IF.

Supported USB-C power delivery:

- 5V/2A
- 9V/2A
- 12V/1.5A
- 15V/1.2A

USB-C power delivery notice

- The information is based on the standard testing criteria and is provided for reference. The compatibility is not guaranteed as the user environments vary. When a separately purchased USB-C cable is used, make sure the cable is certified by USB-IF and is full-featured, with power delivery function.
- A connected device needs to be equipped with a USB-C connector that supports charging function via USB power delivery.
- If the connected device requires more than the power supplied by your projector for operation or for boot up (when the battery is drained), use the original power adapter that came with the device.

Menu navigation

To let you make various adjustments or settings on the projector, the projector provides a settings menu. To access the menu, either press the **PROJECTOR MENU** button on the remote control.

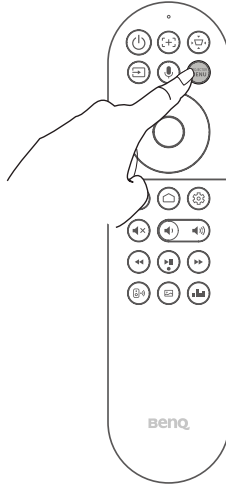

Note

For settings related to the system including wireless connection, account, and app related setting, use the Android TV Settings menu accessible on the home screen. See ["ATV home screen" on page 36](#) for more details.

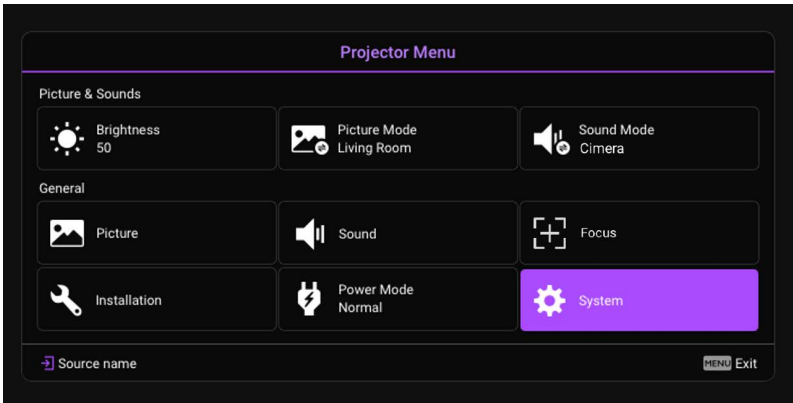

Brightness

Allows you to adjust the brightness of the projector on a scale of 0 to 100.

Picture Mode

Item	Options and descriptions
Bright	Maximizes the brightness of the projected image. This mode is the brightest mode on your projector.
Living Room	With well-saturated colors and fine-tuned sharpness, this mode is slightly brighter than Cinema mode and suitable for playing TV streaming under a small amount of ambient light.
Game	Picture settings appropriate for playing party video games. This mode especially enhances details in dark scenes so that enemies cannot hide.
Sports	With well-saturated colors, this mode is best for watching sporting events.
Cinema	With accurate colors and deepest contrast at a lower brightness level, this mode is suitable for playing movies in an environment with a bit of ambient light.
Day time	By brightening dim regions of images, this mode is suitable for use in lit spaces.

Sound Mode

Item	Options and descriptions
Standard	This mode is suitable for watching streaming content such as drama series, TV shows and news broadcast.
Cinema Extra Bass	This mode emphasizes low frequency sound effect, just like ideal movie theater, the audience is surrounded by deeper cinematic bass. This mode balances the background music and movie sound effect and especially enhances stereo bass sound effect for explosive action scene, such as gunshots and firefights. That's why this mode is suitable for various type of movies, such as serious drama, musical and comedy.

Item	Options and descriptions
Music	This mode emphasizes total balance (low, middle, high frequency) to fully display the timbre of musical instrument, rhythm of symphony and solos of singer in the hot concert or in live hall for different type of music, like pop, rock, and jazz. To reproduce immersive atmosphere or the presence of sound stage, this mode especially enhances the beat of rhythm instruments, the stereo sound space and the vividness of singer.
Game	This mode not only emphasizes clear position and spatial dynamic to enhance directional sound.
Sports	This mode allows you to enjoy the rich vividness of sport broadcasts and light entertainment programs. The commentators' voice is clear and high pitch shrill cheers from the audience is processed.
User	In this mode you can adjust frequency setting according to your needs.

Picture

Item	Options and descriptions
Picture Mode	The projector is preset with several predefined picture modes so that you can choose one to suit your operating environment and input signal picture type. See " Picture Mode " on page 47 for details.
Brightness	The higher the value, the brighter the image. Adjust this control so the black areas of the image appear just as black and that detail in the dark areas is visible.
Contrast	The higher the value, the greater the contrast. Use this to set the peak white level after you have previously adjusted the Brightness setting to suit your selected input and viewing environment.
Color	Lower setting produces less saturated colors. If the setting is too high, colors on the image will be overpowering, which makes the image unrealistic.

Item	Options and descriptions
Sharpness	The higher the value, the sharper the picture becomes.

Sound

Item	Options and descriptions
Sound Mode	Sound Mode utilizes sound enhancement technology, which incorporates Waves' algorithms to deliver great effects of the bass and treble and provide you with immersive cinematic audio experience. See "Sound Mode" on page 47 and "Customizing a sound mode" on page 38 .
100Hz	Displays the frequency band information of each sound mode. If Sound Mode is set to User , you can adjust frequency as desired. See "Customizing a sound mode" on page 38 for more information. Select desired frequency bands to adjust the levels according to your preference. The settings made here define the User mode.
300Hz	
1KHz	
3KHz	
10KHz	
Reset Audio Settings	You can reset to factory defaults.

Focus

Item	Options and descriptions
Real Time Adjustment	Allows the projector to adjust the focus settings in real time.
Sensitivity	Allows you to set the level of sensibility the Real Time Adjustment function uses to make the adjustments.
Manual Focus	Allows you to manually adjust the focus for the projected image.

Installation

Item	Options and descriptions
Projector Position	Chooses the position in which the projector is installed. See "Choosing a location" on page 21 for more details.
Auto Vertical Keystone	Enables/Disables the projector's automatic keystone adjustment.
Vertical Keystone Correction	Allows you to manually adjust the keystone settings for the projected image. See "Keystone" on page 34 for more details.
HDMI Format	Selects a suitable color format to optimize display quality.
Aspect Ratio	<p>There are several options to set the image's aspect ratio depending on your input signal source.</p> <ul style="list-style-type: none"> • Auto: Scales an image proportionally to fit the projector's native resolution in its horizontal or vertical width. • Real: Projects an image as its original resolution and resizes it to fit within the display area. For input signals with lower resolutions, the projected image will be displayed in its original size. • 4:3: Scales an image so that it is displayed in the center of the screen with a 4:3 aspect ratio. • 16:9: Scales an image so that it is displayed in the center of the screen with a 16:9 aspect ratio.
Test Pattern	Displays the test pattern grid, which helps you adjust the image size and focus to check if the projected image is free of distortion.

Item	Options and descriptions
High Altitude Mode	<p>We recommend you use the High Altitude Mode when your environment is between 1500 m - 2000 m above sea level, and ambient temperature is between 0°C to 30°C. Operation under High Altitude Mode may cause a higher decibel operating noise level because of increased fan speed necessary to improve overall system cooling and performance.</p> <p>If you use this projector under other extreme conditions excluding the above, it may display auto shut-down symptoms, which is designed to protect your projector from over-heating. In cases like this, you should switch to High Altitude Mode to solve these symptoms. However, this is not to state that this projector can operate under any and all harsh or extreme conditions.</p>

Power Mode

Item	Options and descriptions
Normal	100% LED brightness.
Eco	This setting reduces system noise and power consumption by 30%. If Eco mode is selected, the light output will be reduced and result in darker projected pictures.
Low Power Consumption	Lowers brightness to 50% to extend the LED life.

System

Item	Options and descriptions
Language	Sets the language for the projector.
Use remote control to power on	Sets to power on the projector via the power button on the remote control. Once enabled, the projector scans for remote control signals when it is powered off and may drain battery power quickly.
Turn off the Backlight of the remote control	Displays the tip to turn off remote control backlight. See " Turning remote control backlight on/off " on page 20 for more information.
System Update	Allows you to update the software on the projector via a USB flash drive. See " Upgrading your projector " on page 32 for more information.
System Information	Displays hardware/software information for the projector including its device and serial number.
Projector Information	Displays information on the current status of the projector including the Detected Resolution, Source, Picture Mode, Power Mode, Color System, Light Usage Time, Firmware Version, and Service Code.
Factory Reset	Returns the projector to its factory default state. Note This function resets your projector only. If you wish to reset your ATV dongle (QS02), perform factory reset from the Android settings menu.

Maintenance

Care of the projector

Your projector needs little maintenance. The only thing you have to do on a regular basis is keep the lens clean.

Never remove any parts of the projector. Contact your dealer or local customer service center if the projector fails to operate as expected.

Cleaning the lens

Clean the lens whenever you notice dirt or dust on the surface. Please be sure to turn off the projector and let it cool down completely before cleaning the lens.

- Use a canister of compressed air to remove dust.
- If there is dirt or smears, use lens-cleaning paper or moisten a soft cloth with lens cleaner and gently wipe the lens surface.
- Never use any type of abrasive pad, alkaline/acid cleaner, scouring powder, or volatile solvent, such as alcohol, benzene, thinner or insecticide. Using such materials or maintaining prolonged contact with rubber or vinyl materials may result in damage to the projector surface and cabinet material.

Note

Never use wax, alcohol, benzene, thinner or other chemical detergents. These can damage the case.

Storing the projector

If you need to store the projector for an extended time, please follow the instructions below:

- Make sure the temperature and humidity of the storage area are within the recommended range for the projector. Please refer to ["Specifications" on page 57](#) or consult your dealer about the range.
- Retract the adjustable feet/kickstand (if available).
- Remove the batteries from the remote control.
- Pack the projector in its original packing or equivalent.

Transporting the projector

It is recommended that you ship the projector with its original packing or equivalent.

Light source information

Go to **PROJECTOR MENU** > **System** > **Projector Information** and press **OK**. The **Projector Information** page appears.

Extending LED life

The LED headlight includes a bulb which features a light-source life far beyond traditional bulbs, yet it is still a consumable item. To keep the LED life as long as possible, you can change the following settings via the settings menu.

Go to **Power Mode** and select a suitable light source mode from among the provided modes.

Set the projector to **Eco** or **Low Power Consumption** mode to extend the LED life.

Light source mode	Description
Normal	100% LED brightness.
Eco	This setting reduces system noise and power consumption by 30%. If Eco mode is selected, the light output will be reduced and result in darker projected pictures.
Low Power Consumption	Lower its power consumption to 50% to extend the LED life.

Troubleshooting

 The LED indicator is flashing.

Scenario	LED status
Driver board error	Flashing red/blue
Fan error	Flashing blue/green
Optical engine temperature error	Flashing red
G sensor Error	Flashing red/blue/green

Contact customer service for assistance.

Note

Refer to "[Power LED indicator](#)" on page 29 for power LED indicator details.

 The projector does not turn on.

Cause	Remedy
There is no power from the power cord.	Plug the power cord into the AC power jack on the projector, and plug the power cord into the power outlet. If the power outlet has a switch, make sure that it is switched on.
Attempting to turn the projector on again during the cooling process.	Wait until the cooling down process has completed.

 No picture.

Cause	Remedy
The video source is not turned on or connected correctly.	<ul style="list-style-type: none">• Check if the video source is properly connected.• The projector may be in Audio-only or power saving mode. Press the power key to disable.
The projector is not correctly connected to the input signal device.	Check the connection.

Cause	Remedy
The input signal has not been correctly selected.	Select the correct input signal with the  key.

 Blurred image

Cause	Remedy
The projection lens is not correctly focused.	Adjust the focus of the lens. See "Fine-tuning the image clarity" on page 34.
The projector and the screen are not aligned properly.	Adjust the projection angle and direction as well as the height of the projector if necessary.
The auto vertical keystone function did not work.	Adjust the projection angle.

 Remote control does not work.

Cause	Remedy
The batteries are out of power	Replace both of the batteries with new ones.
There is an obstacle between the remote control and the projector.	Remove the obstacle.
You are too far away from the projector	Stand within 8 meters (26 feet) of the projector.

 Screen brightness adjustment.

Cause	Remedy
The screen is not as bright as expected.	The screen brightness is changed by the light source mode. Check the light source mode from Power Mode . Choose Normal to have the full light source brightness. Note that this option also consumes more power than other options.

Specifications

Projector specifications

Category	Item	Descriptions
Display	Brightness (ANSI lumens)	300
	Native Resolution	1080P (1920x1080)
	Native Aspect Ratio	16:9
	Contrast Ratio (FOFO)	100,000:1
	Display Color	24-bit (16.7 million colors)
	Light Source	LED
	Light Source Life	Eco: 30000 hours Normal: 20000 hours
Optical	Throw Ratio	1.2
	Zoom Ratio	Fixed
	Lens	Fixed
	Projection Offset (Full-Height)	100%
	Keystone Adjustment	1D, (Auto) Vertical \pm 40 degrees
	Clear Image Size	30" – 120"
Picture	Rec. 709 Coverage	98%
Compatibility	Input Lag	45ms (1080p@60Hz)
	Resolution Support	VGA(640 x 480) to Full HD(1920 x 1080)
	Horizontal Frequency	25K – 85KHz
	Vertical Scan Rate	22 – 62Hz
	HDTV Compatibility	480i, 480p, 576i, 576p, 720p, 1080i, 1080p
I/O Interface	HDMI in	(x2) HDMI-1 (1.4b/HDCP1.4) HDMI-Internal (1.4b/HDCP1.4)
		(x1) USB Type A-1 (2.0/Power Supply 1.0A/ Reader)
	USB Type C	(x1) Display Port/ PD in 15V-3A; 20V-2.25A to 3.25A/ PD out 5V-2A, 9V-2A, 12V-1.5A, 15V1.2A [*] / FW Upgrade
Audio	Speaker	(x2) 4W
	Audio out (3.5mm Mini Jack)	(x1)
	Woofers	8W Chamber

Category	Item	Descriptions
Environment	Power Supply	AC 100 to 240 V, 50/60 Hz
	Typical Power Consumption	45W@100 – 240VAC
	Acoustic Noise (Typ./Eco.)(dB)	28dBA/26dBA
	Operating Temperature	0 – 400
	Storage Temperature	-20 – 60°C, without condensation
	Operating Relative Humidity	10 – 90%RH, without condensation
	Storage Relative Humidity	10 – 90%RH, without condensation
Battery	Battery Cell Type	Lithium-ion
	Battery Life	Video Playing Time: approximately 180 mins
		Music Playing Time: approximately 300 mins
Battery Life Cycle	500 Cycles	
Mechanical Features	Projection angle (Portable only)	135
Smart Features	Bluetooth	Bluetooth 5.0
	Wi-Fi Standard	802.11a/b/g/n/ac/ax(2.4GHz/5GHz)
Dimensions and Weight	Net Weight (kg)	1.7 kg
	Net Weight (lb)	3.7lb
	Dimensions (WxHxD) (mm)	131.3(W) x 203.2(H) x 191.4(D)
	Dimensions (WxHxD) (inch)	5.2(W) x 8(H) x 7.5(D)
Projections System	Projection System	DLP
	DMD size	0.23" Pico

Note

- LED life results will vary depending on environmental conditions and usage.
- The performance of Wi-Fi and Bluetooth might be disturbed by distance and obstacles.
- Battery life may vary by the content played, the media source, or the projector settings.
- *: PD out is available only when the projector is supplied power by the power adapter came with your product.

Timing chart

Resolution	Resolution	Vertical frequency (Hz)	Horizontal frequency (KHz)	Dot Clock Frequency (MHz)
640 x 480	VGA_60	59.940	31.469	25.175
	VGA_72	72.809	37.861	31.500
	VGA_75	75.000	37.500	31.500
	VGA_85	85.008	43.269	36.000
720 x 400	720x400_70	70.087	31.469	28.322
800 x 600	SVGA_60	60.317	37.879	40.000
	SVGA_72	72.188	48.077	50.000
	SVGA_75	75.000	46.875	49.500
	SVGA_85	85.061	53.674	56.250
1024 x 768	XGA_60	60.004	48.363	65.000
	XGA_70	70.069	56.476	75.000
	XGA_75	75.029	60.023	78.750
	XGA_85	84.997	68.667	94.500
1152 x 864	1152 x 864_75	75.000	67.500	108.000
1024x576	BenQ Notebook Timing	60.000	35.820	46.996
1024x600	BenQ Notebook Timing	64.995	41.467	51.419
1280x720	1280 x 720_60	60.000	45.000	74.250
1280 x 768	1280 x 768_60 (Reduce Blanking)	60.000	47.396	68.250
	1280 x 768_60	59.870	47.776	79.500
1280 x 800	WXGA_60	59.810	49.702	83.500
	WXGA_75	74.934	62.795	106.500
	WXGA_85	84.880	71.554	122.500
1280 x 1024	SXGA_60	60.020	63.981	108.000
	SXGA_75	75.025	79.976	135.000
	SXGA_85	85.024	91.146	157.500
1280 x 960	1280 x 960_60	60.000	60.000	108.000
	1280 x 960_85	85.002	85.938	148.500

Resolution	Resolution	Vertical frequency (Hz)	Horizontal frequency (KHz)	Dot Clock Frequency (MHz)
1360 x 768	1360 x 768_60	60.015	47.712	85.500
1440 x 900	WXGA+_60 (Reduce Blanking)	60.000	55.469	88.750
	WXGA+_60	59.887	55.935	106.500
1400X1050	SXGA+_60	59.978	65.317	121.750
1600x1200	UXGA	60.000	75.000	162.000
1680x1050	1680x1050_60 (Reduce Blanking)	59.883	64.674	119.000
	1680x1050_60	59.954	65.290	146.250
640x480 @67Hz	MAC13	66.667	35.000	30.240
832x624 @75Hz	MAC16	74.546	49.722	57.280
1024x768 @75Hz	MAC19	75.020	60.241	80.000
1152x870 @75Hz	MAC21	75.060	68.680	100.000
1920x1080 @60HZ	1920X1080_60	60.000	67.500	148.500
1920X1080 (VESA)	1920X1080_60 (for Auditorium model)	59.963	67.158	173.000

Video timings

Resolution	Resolution	Vertical frequency (Hz)	Horizontal frequency (KHz)	Dot Clock Frequency (MHz)
480i	720(1440) x 480	15.730	59.940	27.000
480p	720 x 480	31.470	59.940	27.000
576i	720(1440) x 576	15.630	50.000	27.000
576p	720 x 576	31.250	50.000	27.000
720/50p	1280 x 720	37.500	50.000	74.250
720/60p	1280 x 720	45.000	60.000	74.250
1080/24P	1920 x 1080	27.000	24.000	74.250
1080/25P	1920 x 1080	28.130	25.000	74.250
1080/30P	1920 x 1080	33.750	30.000	74.250
1080/50i	1920 x 1080	28.130	50.000	74.250

Resolution	Resolution	Vertical frequency (Hz)	Horizontal frequency (KHz)	Dot Clock Frequency (MHz)
1080/60i	1920 x 1080	33.750	60.000	74.250
1080/50P	1920 x 1080	56.250	50.000	148.500
1080/60P	1920 x 1080	67.500	60.000	148.500

Supported file formats

The projector's media reader is powered by the supplied Android TV dongle QS02. See QS02 user manual from [Support.BenQ.com](https://support.benq.com) for the supported file formats.

For details on the supported media formats, please visit: <https://developer.android.com/guide/topics/media/media-formats>

Appendix

Working with a tripod (purchased separately)

Use a tripod plate to mount the projector onto a tripod:

1. Install the tripod's quick release plate to the projector's tripod screw hole and tighten the plate's screw.

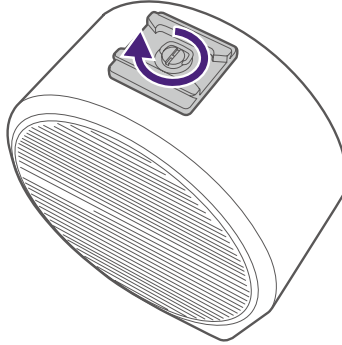

2. Install the projector onto the tripod.

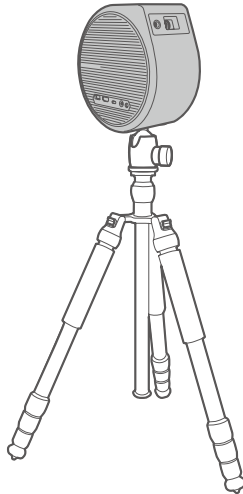





The tripod screw hole on the bottom of your projector is not designed for ceiling mount installation. If you choose a ceiling location for your projector, refer to ["Front Ceiling"](#) on page 21 and ["Rear Ceiling"](#) on page 22 for instructions.

Pairing with a new remote control

Compatible BenQ remote control model: RCI077

In case you have received a new remote control from BenQ customer service, you need to pair it with your projector (with ATV dongle QS02 installed) before use.

1. Make sure the projector (with ATV dongle QS02 installed) is powered on and the batteries are installed to the remote control.
2. Keep the remote control close to your projector within 20 cm.
3. Press the  and  buttons together on the remote control to bring up the pairing screen.
4. Press and hold the  and  buttons together again for 10 seconds as instructed to start pairing. Follow the on-screen instructions to complete.

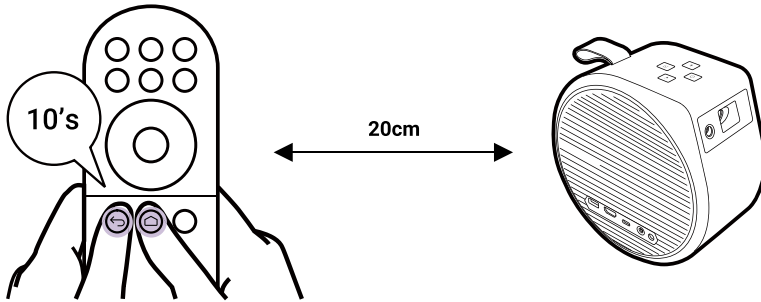

Copyright & disclaimer

Copyright

Copyright © 2023 by BenQ Corporation. All rights reserved. No part of this publication may be reproduced, transmitted, transcribed, stored in a retrieval system or translated into any language or computer language, in any form or by any means, electronic, mechanical, magnetic, optical, chemical, manual or otherwise, without the prior written permission of BenQ Corporation.

All other logos, products, or company names mentioned in this manual may be the registered trademarks or copyrights of their respective companies, and are used for informational purposes only.

Android™ is a trademark of Google LLC.

The Bluetooth® word mark and logos are registered trademarks owned by Bluetooth SIG, Inc. and any use of such marks by BenQ Corporation is under license.

iOS is a trademark or registered trademark of Cisco in the U.S. and other countries and is used under license.

macOS® is a trademark of Apple Inc., registered in the U.S. and other countries.

Disclaimer

BenQ Corporation makes no representations or warranties, either expressed or implied, with respect to the contents hereof and specifically disclaims any warranties, merchantability or fitness for any particular purpose. Further, BenQ Corporation reserves the right to revise this publication and to make changes from time to time in the contents hereof without obligation of BenQ Corporation to notify any person of such revision or changes. This user manual aims to provide the most updated and accurate information to customers, and thus all contents may be modified from time to time without prior notice. Please visit <http://support.benq.com> for the latest version of this manual.

It is the sole responsibility of the user if problems (such as data loss and system failure) occurred due to non-factory installed software, parts, and/or non-original accessories.

Warranty

BenQ warrants this product against any defects in material and workmanship, under normal usage and storage.

Proof of purchase date will be required with any warranty claim. In the event this product is found to be defective within the warranty period, BenQ's only obligation and your exclusive remedy shall be replacement of any defective parts (labor included). To obtain warranty service, immediately notify the dealer from which you purchased the product of any defects.

Important: The above warranty shall be void if the customer fails to operate the product in accordance with BenQ's written instructions, especially the ambient humidity must be in-between 10% and 90%, temperature in-between 0°C and 40°C, altitude lower than 2000 meters, and avoiding to operate the projector in a dusty environment. This warranty gives you specific legal rights, and you may have other rights which vary from country to country.

For other information, please visit www.BenQ.com.

Statement regarding hyperlinks and third-party websites

BenQ is not responsible for the content of the websites or of similar resources, which are maintained and controlled by third parties, that may be linked from this product. Providing links to those websites or to similar resources does not mean that BenQ makes any warranty or representation to their content by expression or by implication.

Any third party content or service preinstalled in this product is provided "as is". BenQ does not, by expression or by implication, make any warrant to the content or to the services provided by third parties. BenQ does not warrant or guarantee that the content or services provided by third parties are accurate, effective, most up-to-date, legal, or complete. Under no circumstances shall BenQ be liable for the content or services provided by third parties including their negligence.

Services provided by third parties may be terminated temporarily or permanently. BenQ does not warrant or guarantee that any content or services provided by third parties are in good condition at any time, and is

not liable for the termination of the said content and services. In addition, BenQ is not involved in any transactions you conduct in the websites or similar resources maintained by third parties. You should contact the content or service providers for any questions, concerns, or disputes.

BenQ ecoFACTS

BenQ has been dedicated to the design and development of greener product as part of its aspiration to realize the ideal of the "Bringing Enjoyment 'N Quality to Life" corporate vision with the ultimate goal to achieve a low-carbon society. Besides meeting international regulatory requirement and standards pertaining to environmental management, BenQ has spared no efforts in pushing our initiatives further to incorporate life cycle design in the aspects of material selection, manufacturing, packaging, transportation, using and disposal of the products. BenQ ecoFACTS label lists key eco-friendly design highlights of each product, hoping to ensure that consumers make informed green choices at purchase.

Check out BenQ's CSR Website at <http://csr.BenQ.com/> for more details on BenQ's environmental commitments and achievements.



BenQ.com

© 2023 BenQ Corporation.
All rights reserved. Rights of modification reserved.