

AVer PTZ Link

User Manual



Disclaimer

No warranty or representation, either expressed or implied, is made with respect to the contents of this documentation, its quality, performance, merchantability, or fitness for a particular purpose. Information presented in this documentation has been carefully checked for reliability; however, no responsibility is assumed for inaccuracies. The information contained in this documentation is subject to change without notice.

In no event will AVer Information Inc. be liable for direct, indirect, special, incidental, or consequential damages arising out of the use or inability to use this product or documentation, even if advised of the possibility of such damages.

Trademarks

“AVer” is a trademark owned by AVer Information Inc. Other trademarks used herein for description purpose only belong to each of their companies.

Copyright

© 2023 AVer Information Inc. All rights reserved. | April 20, 2023

All rights of this object belong to AVer Information Inc. Reproduced or transmitted in any form or by any means without the prior written permission of AVer Information Inc. is prohibited. All information or specifications are subject to change without prior notice.

More Help

For FAQs, technical support, software and user manual download, please visit:

Headquarters

Download Center: <https://www.aver.com/download-center>

Technical Support: <https://www.aver.com/technical-support>

USA Branch Office

Download Center: <https://www.averusa.com/pro-av/support>

Technical Support: <https://averusa.force.com/support/s/contactsupport>

Europe Branch Office

Download Center: <https://www.avereurope.com/download-center>

Technical Support: <https://www.avereurope.com/technical-support>

Contact Information

Headquarters

AVer Information Inc.

<https://www.aver.com>

8F, No.157, Da-An Rd., Tucheng Dist., New Taipei City 23673, Taiwan

Tel: +886 (2) 2269 8535

USA Branch Office

AVer Information Inc., Americas

<https://www.averusa.com>

668 Mission Ct., Fremont, CA 94539, USA

Tel: +1 (408) 263 3828

Toll-free: +1 (877) 528 7824

Technical support: support.usa@aver.com

Europe Branch Office

AVer Information Europe B.V.

<https://www.avereurope.com>

Westblaak 134, 3012 KM, Rotterdam, The Netherlands

Tel: +31 (0) 10 7600 550

Technical support: eu.rma@aver.com

Japan Branch Office

アバー・インフォメーション株式会社

<https://jp.aver.com>

〒160-0023 日本東京都新宿区西新宿 3-2-26 立花新宿ビル 7 階

Tel: +81 (0) 3 5989 0290

テクニカル・サポート: <https://jp.aver.com/technical-support>

Vietnam Branch Office

Công ty TNHH AVer Information (Việt Nam)

Tầng 5, 596 Nguyễn Đình Chiểu, P.3, Quận 3,

Thành phố Hồ Chí Minh 700000, Việt Nam

Tel: +84 (0)28 22 539 211

Contents

Overview.....	6
Compare Versions and Features	6
System Requirements.....	7
Supported AVer Cameras.....	7
Supported Microphones.....	8
Audio-Technica.....	8
ClearOne.....	9
Nureva	10
Sennheiser	12
Shure	13
Yamaha	14
Installing AVer PTZ Link	15
Hardware Connection	16
Getting Started.....	17
PTZ Link Main page.....	17
Device List.....	19
Priority Group	20
Add Devices.....	22
IP Camera Connection.....	22
Virtual Camera (USB) Connection	25
Voice Tracking Configuration	28
Channel Setup	29
Set Up Preset Positions	30
Pair Up Preset Positions with Microphone	33
Active Position Setup	38
PTZ Link Information.....	45
System.....	46
License.....	48

Camera Setting	57
HTTP Request	59
Help Center	61
About.....	61
Privacy Policy.....	62
Minimize and Restore AVer PTZ Link	63
Exit AVer PTZ Link	64
Troubleshooting	65
Appendix.....	69
AVerCamera Setting Tool	69
Control Panel	71

Overview

AVer PTZ Link is an application software that connects AVer cameras to third-party microphone systems (supported models) from Audio-Technica, ClearOne, Nureva, Sennheiser, Shure and Yamaha. It provides IP-based control and enables users to turn AVer cameras into voice tracking cameras by setting preset points. It also enables users to create virtual cameras, perform automatic video switching, as well as tracking the presenter when human tracking is enabled in the Premium version.

Compare Versions and Features

Features	Free	Premium (60-Day Trial)
IP connectivity	✓	✓
USB connectivity		✓
Virtual camera*		✓
Automatic video switching*		✓
Human tracking		✓
Active position		✓
AVer camera + microphone group	5	25
Microphone channel	8	128
Preset point	256	256

*Windows app only

System Requirements

	Minimum	Recommended
OS	Windows 7 (64-bit) or later macOS 10 or later	Windows 7 (64-bit) or later macOS 10 or later
CPU	Intel Core i5 10th Generation	Intel Core i7-10875H or greater
GPU		NVidia Geforce RTX 2070 or greater
RAM	8 GB	16 GB DDR4 or greater
Free storage space	800 MB	800 MB

Supported AVer Cameras

PTC V2 Series	PTC500 Series	PTC330 Series	PTC310 Series	PTC115 Series
PTC330UV2 <i>TR333V2</i>	PTC500S <i>TR530</i>	PTC330 <i>TR331</i>	PTC310 <i>TR311</i>	PTC115 <i>TR320</i>
PTC320UNV2 <i>TR323NV2</i>	PTC500+ <i>TR530+</i>	PTC330N <i>TR331N</i>	PTC310U <i>TR313</i>	PTC115+ <i>TR320+</i>
PTC320UV2		PTC330U <i>TR333</i>	PTC310H	
PTC310UV2 <i>TR313V2</i>			PTC310N <i>TR311N</i>	
PTC310HVV2 <i>TR311HVV2</i>			PTC310UN <i>TR313N</i>	
			PTC310HN	

PTZ330V2 Series	PTZ310V2 Series	PTZ330 Series	PTZ310 Series
PTZ330V2	PTZ310V2	PTZ330	PTZ310
PTZ330NV2	PTZ310NV2	PTZ330N	PTZ310N
PTZ330UV2	PTZ310UV2		
PTZ330UNV2	PTZ310UNV2		

DL Series

DL30

*US model name in italics

**Orange models do not support human tracking.

Supported Microphones

Some models may require setup in their manufacture software before using PTZ Link.

Audio-Technica

- ATND1061 Beamforming Ceiling Array Microphone

Digital Microphone Manager Setup

1. Turn on **Notification** and **Camera Control Notification** in Digital Microphone Manager.

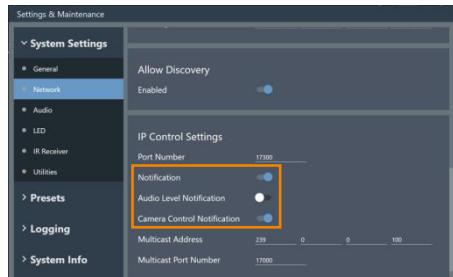

2. Add a Camera Area in Digital Microphone Manager. Each Camera Area group corresponds to Channel 1-8 in PTZ Link.

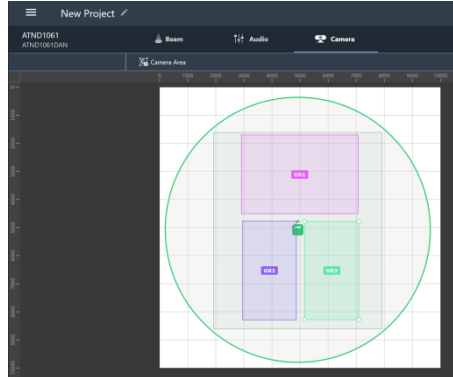

ClearOne

- BMA 360 Microphone System
- CONVERGE® Pro 2

CONVERGE® Pro 2 supports up to 3 daisy-chained BMA 360s.

PTZ Link Setup

1. PTZ Link assigns 12 fixed channels to each BMA 360. Unused channels are retained in the assigned BMA 360 as shown below.
2. When adding your device in the PTZ Link, select your MIC channels in the drop-down list.

Daisy-Chained	Channel Start/End
1 st BMA 360	1-12
2 nd BMA 360	13-24
3 rd BMA 360	25-36

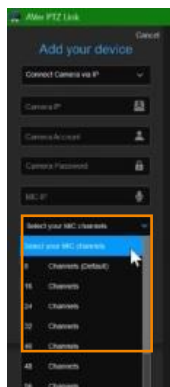

Nureva

PTZ Link divides the HDL microphones' horizontal angles into 8 equal parts, which correspond to PTZ Link Channel 1-8.

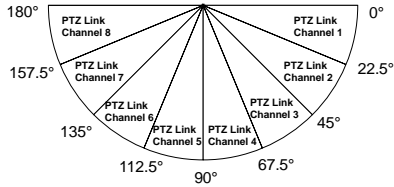

- HDL300
- Dual HDL300

Nureva Console Client Setup

1. Turn on **Camera tracking** and whitelist the IP address of the PC running PTZ Link in the cloud-based Nureva Console Client.
2. In PTZ Link, set the PC running Nureva Console Client's IP address as MIC IP.

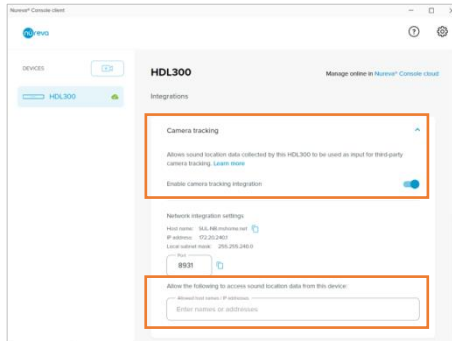

- HDL410

PTZ Link Setup

On the PTZ Link main page, click **Channel Configure**, and then choose a **Pickup Mode** from the drop-down list.

Direction: The microphone's horizontal angles are divided into 8 equal parts, which correspond to PTZ Link Channel 1-8.

Coverage: Click **Coverage Map Setting** and select **Add Coverage** to add a dedicated coverage area. You can add up to 8 coverage areas per microphone. When coverage areas overlap, the microphone will default to the area with the smaller number.

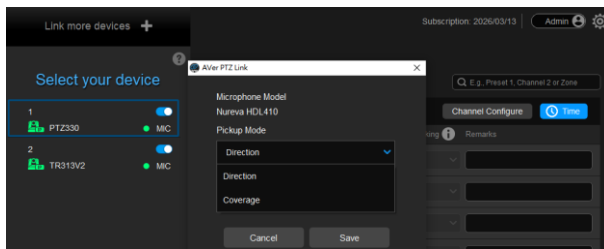

Sennheiser

- **TeamConnect Ceiling 2**

PTZ Link divides TeamConnect Ceiling 2's horizontal angles into 8 equal parts, which correspond to PTZ Link Channel 1-8.

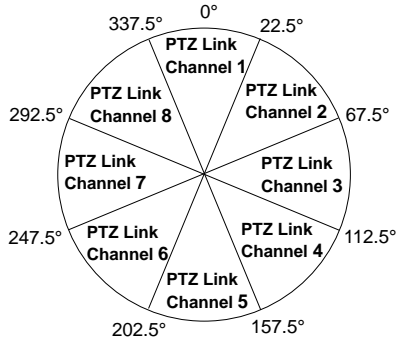

Sennheiser Control Cockpit Setup

An Exclusion Zone set in Sennheiser Control Cockpit also affects the corresponding channel in PTZ Link as illustrated.

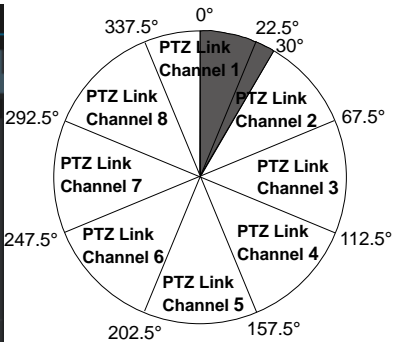

Shure

- Microflex® Complete Wireless
- IntelliMix® P300 Audio Conferencing Processor
- MXA910 Ceiling Array Microphone
- MXA920 Ceiling Array Microphone
- MXA710 Linear Array Microphone

- MXA310 Table Array Microphone

Shure Designer / Web Application Setup

Add more than 1 channel for the microphone in the Shure Designer software or web application. PTZ Link does not support single channel for the MXA310.

- MXA920 Ceiling Array Microphone

Web Application Setup

1. Go to **Settings** > **General** and turn on **Automatic coverage** in the MXA920's web application.
2. Go to **Coverage** > **Add coverage**.

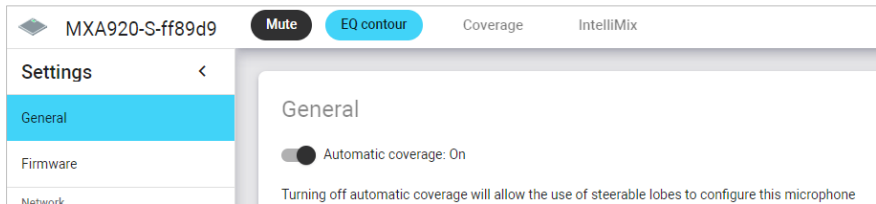

3. On the PTZ Link main page, click **Channel Configure**, and then choose a **Pickup Mode** from the drop-down list.

Lobe: The microphone's angles are divided into 8 equal parts, which correspond to PTZ Link Channel 1-8.

Coverage: The coverage areas you add in the MXA920's web application.

Yamaha

- **RM-CG Ceiling Array Microphone**

PTZ Link divides RM-CG's horizontal angles into 8 equal parts, which correspond to PTZ Link Channel 1-8.

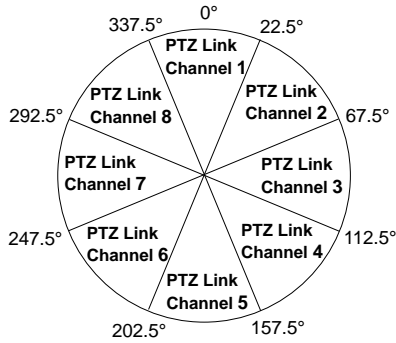

- **RM-TT Tabletop Array Microphone**
- **RM-CR Remote Conference Processor**
- **RM-W Wireless Microphone System**

PTZ Link Setup

PTZ Link voice tracking function requires linking more than one RM-TT or RM-W microphones for location data. When linking these microphones to the RM-CR Remote Conference Processor, set the processor's IP address as MIC IP in PTZ Link.

Installing AVer PTZ Link

1. Download AVer PTZ Link to your computer from AVer Download Center. (<https://www.aver.com/download-center>).
2. The installer includes AVerCamera Setting Tool. Please refer to <[AVerCamera Setting Tool](#)> for more details.
3. Double-click the downloaded .exe file.
4. Follow the instructions displayed on the setup wizard to install AVer PTZ Link.

Hardware Connection

- Please make sure all devices are well-connected and power on.
- Needs to install “**AVer PTZ Link**” application on the server site.
- For IP Camera connection (free version), all devices are suggested to be connected on the same LAN, or UDP port - 52381 & TCP port - 2202 must be available between devices.

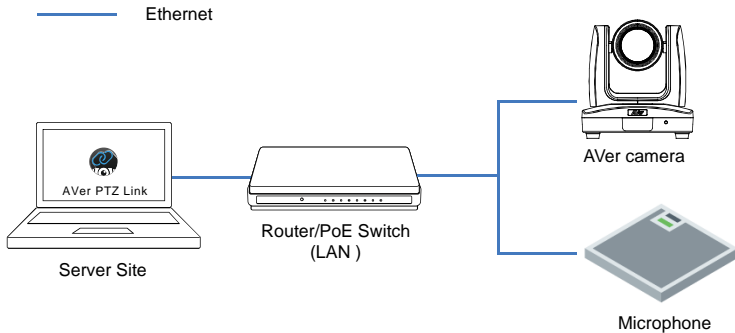

- For Virtual Camera connection (premium version), connect the camera to the USB port on the server site.

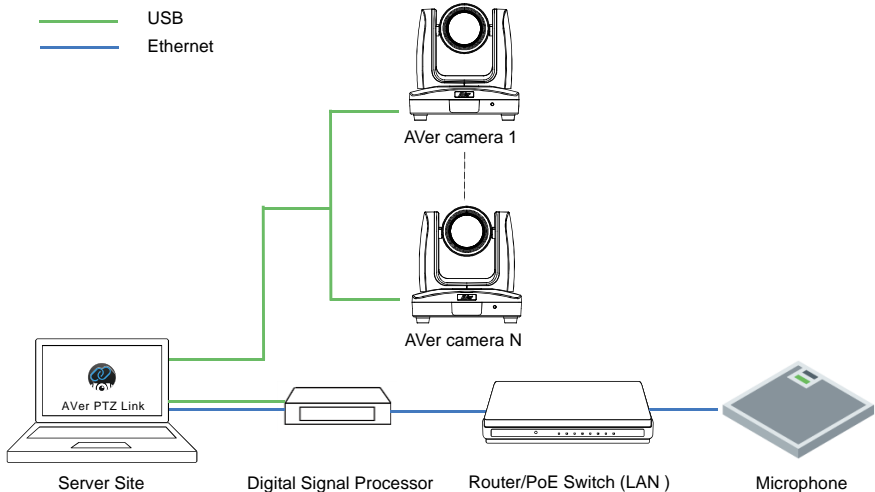

Getting Started

PTZ Link Main page

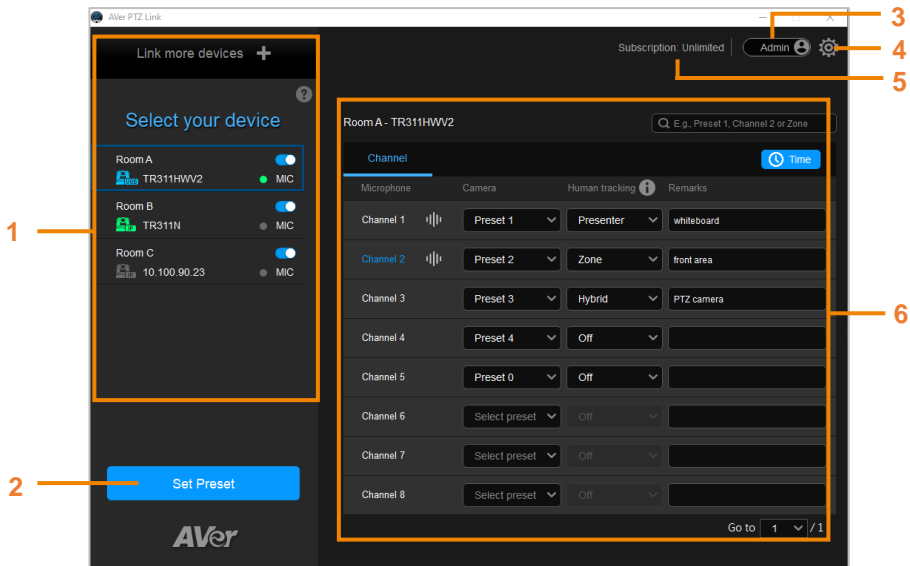

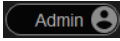
- 1. Device List:** You can use the device list to add/delete/edit or enable/disable the devices. Please refer to [Device List](#) and [Add Devices](#).
- 2. Set Preset:** Click to set up preset positions. This button will only be available when the selected device has been enabled (toggle the switch to enable). Please refer to [Set Up Preset Positions](#) for more details.
- 3. Account Name:** Displays the system (PC) login account. If you have logged in your system with administrator account, when launching PTZ Link, the toggle button will display **Admin** , and you will be able to operate full functions.

If you have logged in your system with other user account, when launching PTZ Link, the toggle button will display **User** , and you will have limited functions to be operated. In this case, you can toggle the button to switch the account to **Admin**. A message window pops up to instruct user to input the password of administrator account to log in. To switch back to the

User account, close the PTZ Link and restart it again.



4. **PTZ Link Information:** You can view system information, change system language, activate premium license and etc. using this page. Please refer to <[PTZ Link Information](#)> for more details.
5. **Expiration Date:** Shows the expiration date of your premium license or the free trial subscription.
6. **Voice Tracking Configuration:** After adding the devices to the program, you can configure **Channel** setup to perform the voice tracking function. Please refer to <[Voice Tracking Configuration](#)> for more details.

Device List

For premium version users, you can add up to 25 device groups (camera and microphone combination) to the Device List. For free version users, up to 5 device groups are supported. AVer PTZ Link supports both IP camera (free version) and USB camera (premium version) connection.

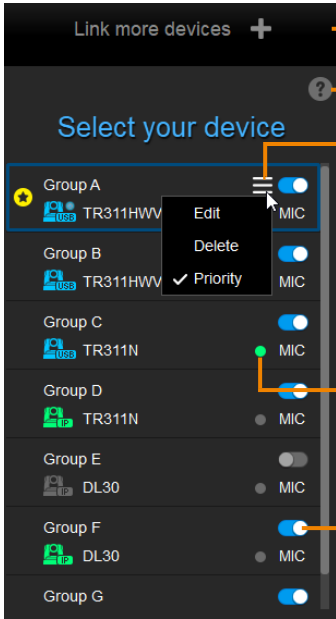

Click to add more device groups

Click to display the Device Status info

Move your mouse cursor over a group to display this icon.

Click **Edit** to edit the group.

Click **Delete** to delete the group from the list.

Click **Priority** to set up this group as the Priority Group (refer to <[Priority Group](#)>).

Display microphone status

Green: online

Gray: offline



Toggle the button to enable or disable the group

Icons below indicate the device status which includes the camera and microphone:

Icon	Device Status
	Device (IP camera) is online.
	Device is offline.
	Virtual Camera is sent to the third party program.
	Virtual Camera (camera connected by USB) is enabled.
	Incorrect account or password.
	Inactivated.

Priority Group

The Priority Group function can be used when multiple groups are sharing the same camera, and when their paired microphones detect the same voice of a person at the same time, the camera will only move to the preset position configured in the Priority Group.

To set up a group as the Priority Group, move your mouse cursor over a group, the  icon appears. Click **Priority**, this group will be marked with the  icon, which indicates this is the Priority Group. To disable priority, click **Priority** again.

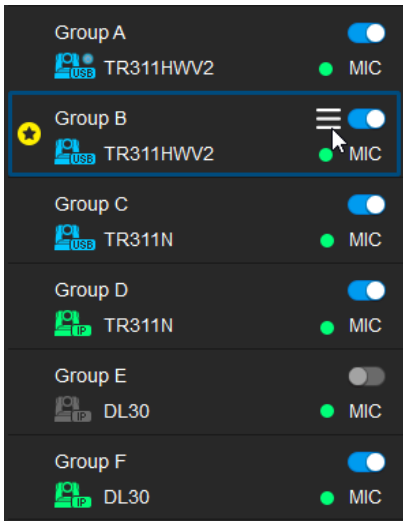

In this image, both Group A and Group B are sharing the same camera (TR311HW2), and the connection of the camera in both groups is via USB. Group B is set up as the Priority Group.

Group A: TR311HW2 + MIC 1
Group B: TR311HW2 + MIC 2 (Priority)

When MIC 1 and MIC 2 both detect a voice from a person at the same time, the TR311HW2 camera will move to the preset position configured in Group B.



Import notes for the Priority function to take effect

- **Only the same camera with the same connection type will take effect**
Take the image above as an example, since the Priority Group can only be applied to the groups paired-up with the same camera, let's see how the Group A with Group B and Group C with Group D will work when applying the Priority Group function.
 - Group A with Group B: The Priority Group will be valid as both of Group A and Group B are sharing the same camera, and the connection types of the camera are both via USB.
 - Group C with Group D: The Priority Group will be invalid. Even though both of Group C and Group D are sharing the same camera, however,

the connection types of the camera are different. Camera in Group C is using USB connection, while the camera in Group D is using IP network connection.

■ **The groups have to be enabled**

Take the Group E and Group F in the above image as an example. If you want to apply the Priority Group to either one of Group E or Group F, the Priority Group will be invalid.

Even though Group E and Group F are sharing the same camera and the connection types of the camera are both via IP network, however, the Group E is not enabled (). For this case, enable the Group E () and the Priority Group will take effect.

Add Devices

You can add up to 5 device groups (free version) or 25 device groups (premium version) to the Device List. AVer PTZ Link supports both IP camera (free version) and USB camera (premium version) connection.

IP Camera Connection

1. Select **Connect Camera via IP** from the device drop-down list.
[Note] If you have added a device group, click **Link more devices +** to start adding another device group.

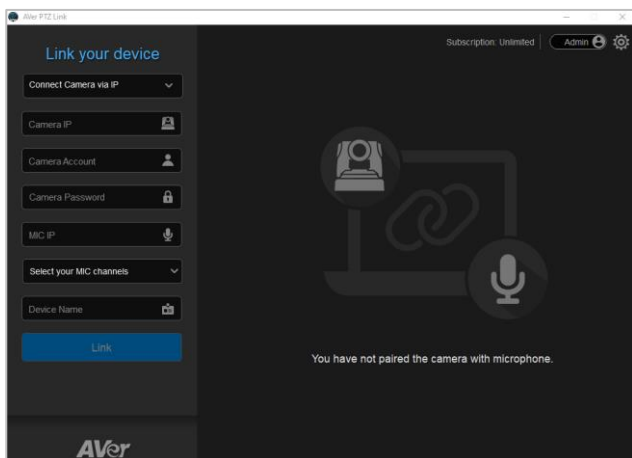

2. Input the IP camera and microphone information.

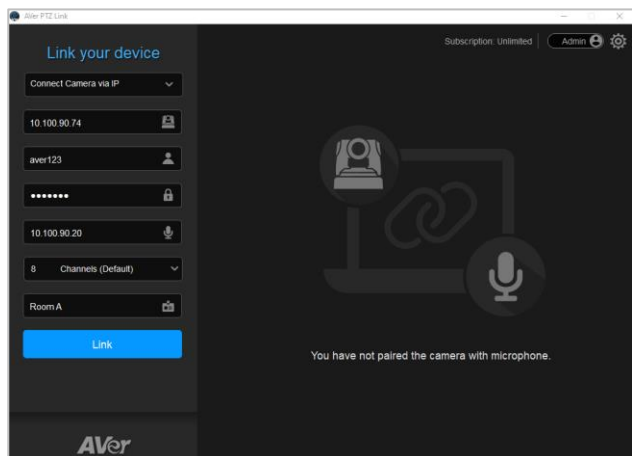

Camera IP: Enter the IP address of the camera (in IPv4 format).

Camera Account: Enter the account ID of the camera.

Camera Password: Enter the password of the camera.

MIC IP: Enter the IP address of the microphone (in IPv4 format).

MIC Channels: Select your microphone channels. 8-channel is provided for free account users by default. Up to 128 channels are provided for premium users.

Device Name: Input a name for this device group (length has to be less than 20 characters).

[Note]

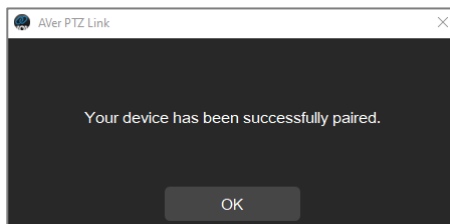

- AVer PTZ Link will memorize the last setting, including device name and preset setup.
 - When AVer PTZ Link launches, the paired devices will automatically run.
 - Links can be created even for the offline cameras.
3. Click **Link** to pair the camera with microphone and a message window will appear. Click **OK** to confirm the settings and a popup will guide you through the process of starting voice tracking and Virtual Camera using PTZ Link. Click **Done** when finish reading.

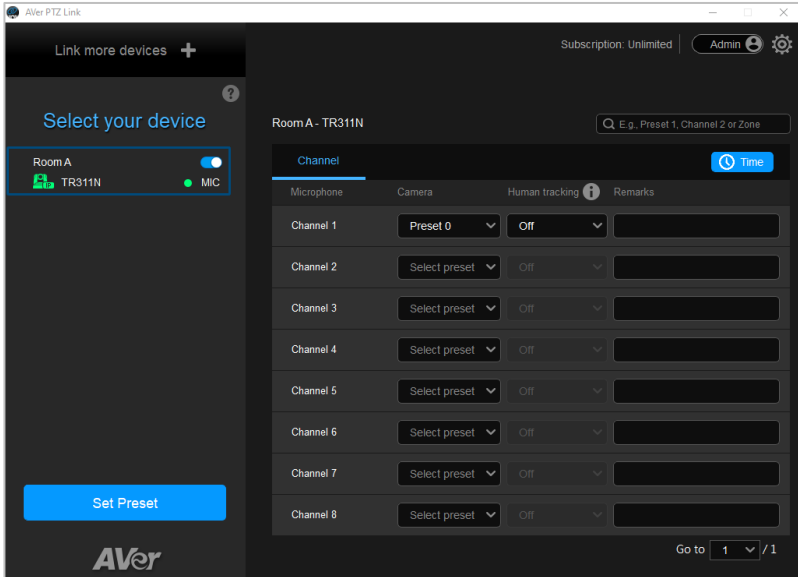

4. The device group has been added to the Device list.



5. Follow the above steps to add more device groups.

6. You can optionally set up the Priority Group if multiple device groups are sharing the same camera. To set up a Priority group, on the Device List, move your mouse cursor over a desired device group to display the  icon, click **Priority**, the group should be marked with the Priority  icon. For more details about Priority Group, please refer to <[Priority Group](#)>.

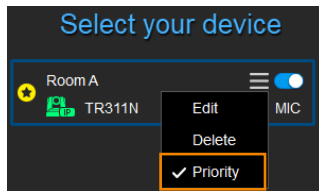

Virtual Camera (USB) Connection

This function is only available for premium users. You can also start a 60-day free trial.

[Note]

- At present, Virtual Camera only supports Windows® OS.
- To maintain video quality during video conference, the lowest output resolution of Virtual Camera is 720p.

1. Ensure the premium license key has been activated. Please refer to [<License>](#).
2. Connect the USB camera to the USB port on the computer/system.
3. Select **Connect Camera via USB** from the device drop-down list. PTZ Link will automatically detect the USB cameras connected to the system.

[Note]

- If you have added a device group, click **Link more devices** to start adding another device group.
- To optimize your Virtual Camera experience, please disable the sleep mode function of the connected Virtual Cameras.

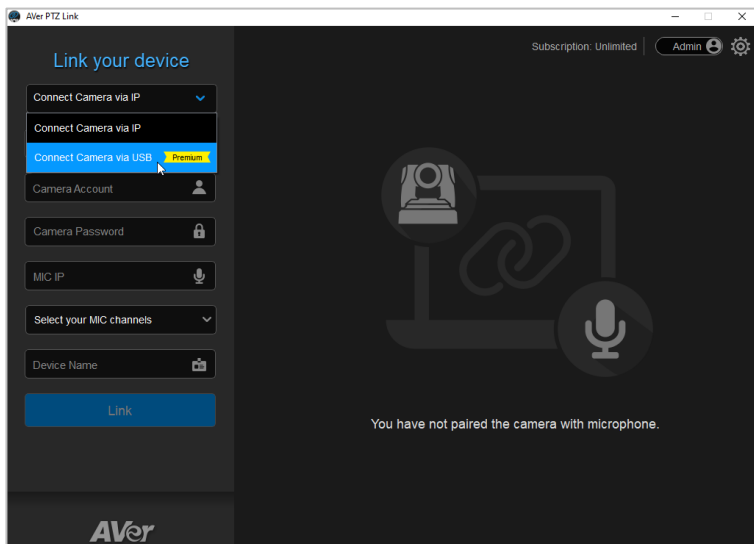

4. Select an USB camera and input the IP address of the microphone.

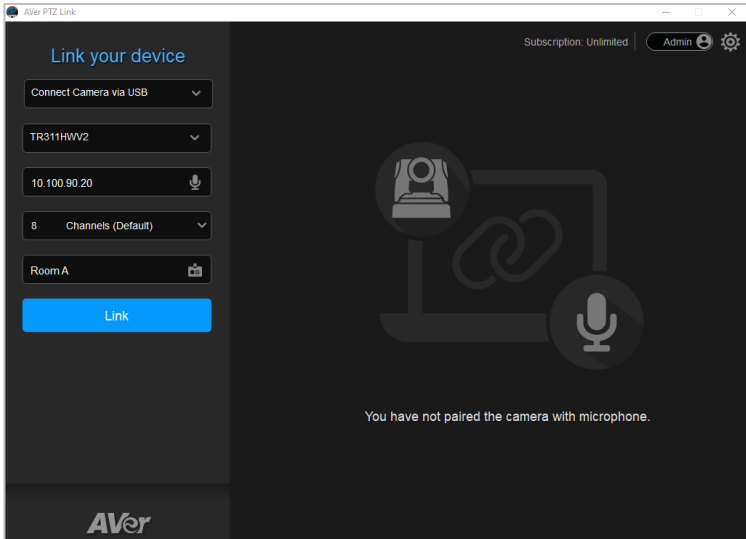

Select Camera: After connecting the USB camera to the computer, the PTZ Link will automatically detect the connected USB cameras. Select a camera from the drop-down list.

MIC IP: Enter the IP address of the microphone (in IPv4 format).

MIC Channels: Select your microphone channels. 8-channel is provided for free account users by default. Up to 128 channels are provided for premium users.

Device Name: Input a name for the device group (length has to be less than 20 characters).

[Note]

- AVer PTZ Link will memorize the last setting, including device name and preset setup.
- When AVer PTZ Link launches, the paired devices will automatically run.

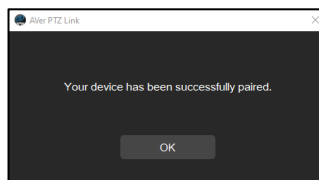

5. Click **Link** to pair the camera with microphone and a message window will appear. Click **OK** to confirm the settings.

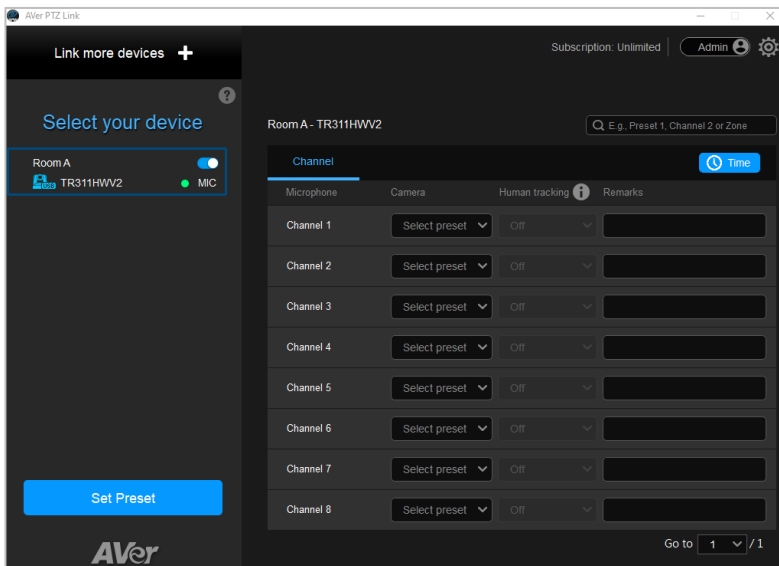

6. The device group has been added to the device list.



7. Follow the above steps to add more device groups.

8. You can optionally set up the Priority Group if multiple device groups are sharing the same camera. To set up a Priority group, on the Device List, move your mouse cursor over a desired device group to display the  icon, click **Priority**, the group should be marked with the Priority  icon. For more details about Priority Group, please refer to <[Priority Group](#)>.

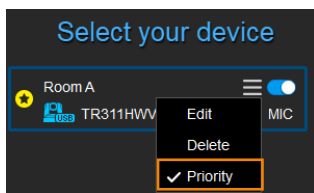

Voice Tracking Configuration

After adding the devices to the program, you can further configure the voice tracking function.

Channel setup can be done by pairing up microphone channels and camera preset positions. When microphone detects sound, the camera will move to the pre-configured position. The Channel setup supports both IP cameras and Virtual Cameras (USB).

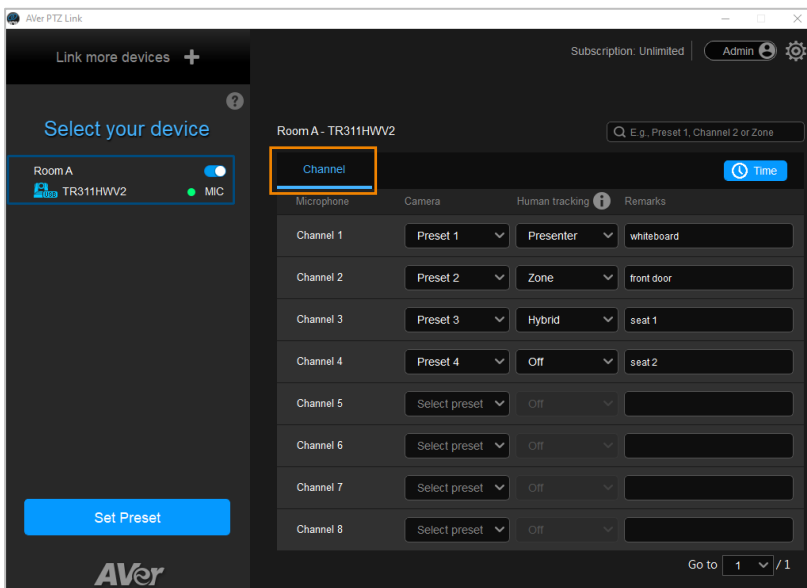

Channel Setup

Channel setup allows users to perform the Voice Tracking function by pairing up microphone channels and camera preset positions. The Channel setup supports both IP cameras and Virtual Cameras (USB).

To enable voice tracking by configuring Channel setup, you need to do the following:

1. Set up preset positions of the cameras. Refer to <[Set Up Preset Positions](#)>.
2. Pair up preset positions with microphone channels. Refer to <[Pair Up Preset Positions with Microphone](#)>.

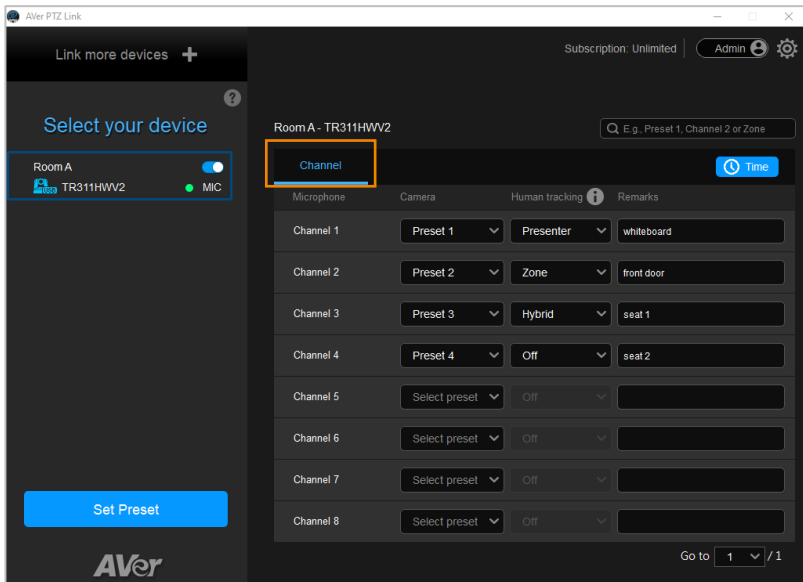

Set Up Preset Positions

After adding the devices, you can start configuring the preset positions of the cameras.

To set up preset positions for IP cameras:

1. Select an IP camera on the Device List by clicking on it. The selected device will be highlighted with a blue frame. Ensure the device has been enabled .

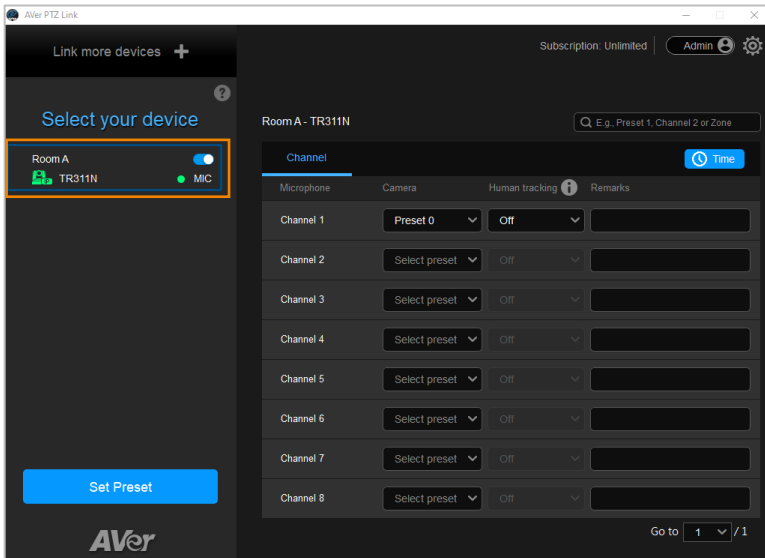

2. Click **Set Preset**, the PTZ Link will direct you to the web page of the IP camera. Input the username and password to login.

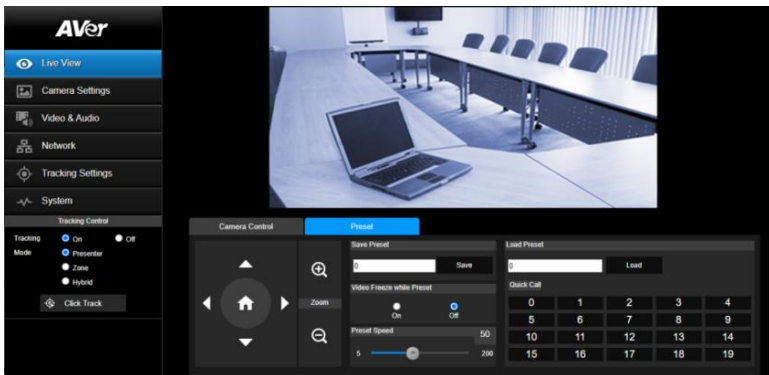

3. On the Live View page, click the **Preset** tab on the bottom panel to set up preset positions.

To set up preset positions, input a preset number in the **Save Preset** input box first, use the direction and zoom in/out buttons to move the camera view to the desired position, and then click the **Save** button to save this position.

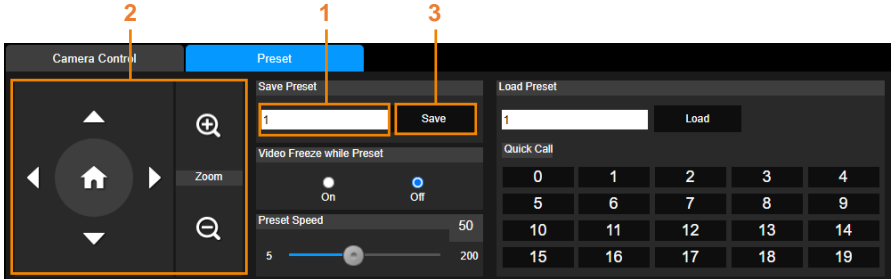

[Note]

- Each camera's web setting page may vary. Please refer to camera's user manual for more details.
 - Up to 256 (0~255) preset points can be set up.
4. After setting up the preset positions, you can start pairing the preset positions with the connected microphone. Please refer to [<Pair Up Preset Positions with Microphone>](#).

To set up preset positions for USB cameras:

1. Select an USB camera on the Device List by clicking on it. The selected device will be highlighted with a blue frame.

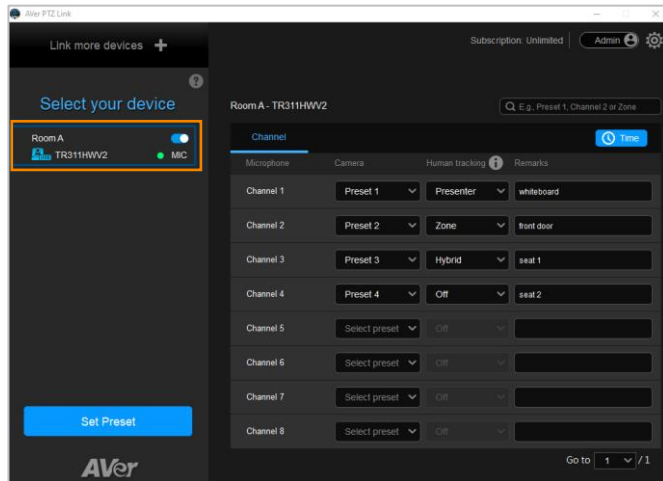

2. Click **Set Preset**, the AVerCamera Setting Tool appears. You can use this tool to set up preset positions. Up to 256 (0~255) preset positions can be set up.



- a. Select a USB camera from the top camera drop-down list.
 - b. To set up a preset position, select a number in the **Preset setting** field, use the direction and zoom in/out buttons to move the camera view to the desired position, and then click the **Save** button to save this position.
3. After setting up the preset positions, you can start pairing the preset positions with the connected microphone. Please refer to <[Pair Up Preset Positions with Microphone](#)>.

Pair Up Preset Positions with Microphone

After setting up camera's preset positions, you can start pairing the preset positions with the connected microphone. When PTZ Link detects voice from the microphone, the corresponding camera will be triggered to the pre-configured preset position.

1. Select a camera on the Device List by clicking on it, the selected device will be highlighted with a blue frame. Ensure the preset positions of the selected camera have been configured.

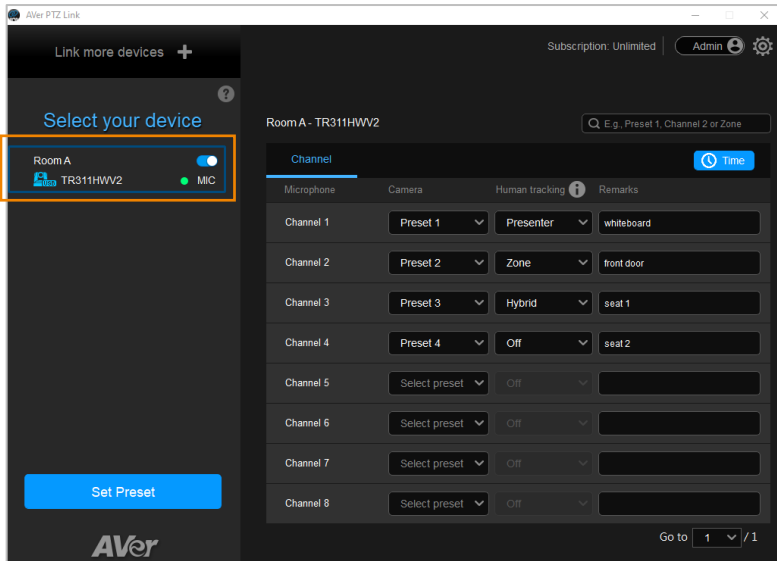

- On the right-side panel, click the **Channel** tab, select the preset position from the Camera drop-down list to the corresponding Microphone channel.

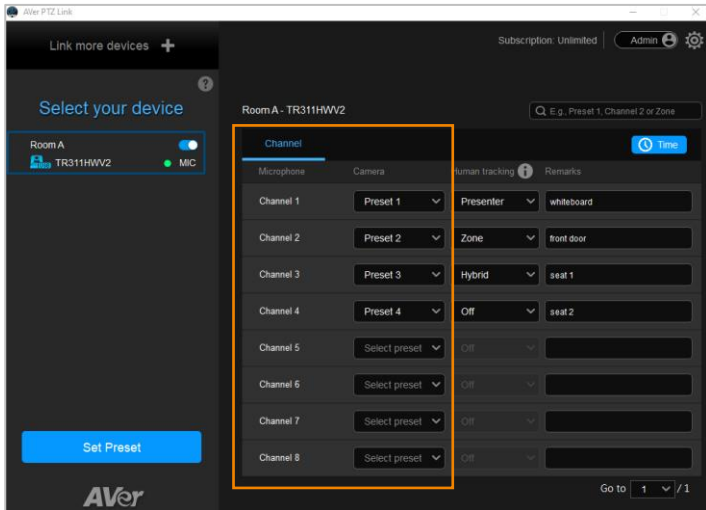

- You can add some notes in the **Remarks** field, which is a reminder of the configured position or the settings. For Virtual Camera (USB), the Remarks (text overlay) can be overlaid on the output of the camera view. Please refer to *Display channel remarks on virtual camera* in the [<Camera Setting>](#) chapter.

For premium users, optionally enable the **Human tracking** function. Select **Presenter/Zone/Hybrid** in the **Human tracking** field to enable the function. If you do not want to enable this function, select **Off**.

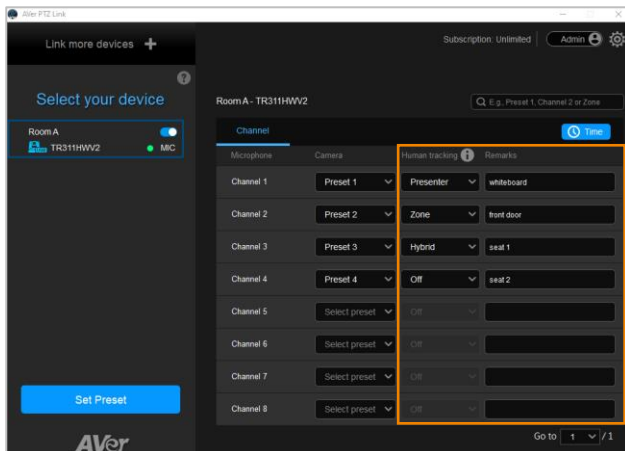

[Notes]

■ To perform the Human tracking function, you will have to pre-configure the related tracking settings on the camera. Please refer to the user's manual of your camera.

■ The supported models of "Human Tracking" function are listed below:

USA region:

- TR310/TR311/TR311HN/TR313/TR331/TR333
- TR313V2/TR333V2
- DL30

Non-USA region:

- PTC310/PTC310U/PTC310H
- PTC330UV2
- DL30

To incorporate voice tracking with human tracking, you may enable "Human Tracking" in this section. A possible use case might be:

Set the presenter area of the training room as MIC Channel 1, pair up with camera Preset 1, then choose Presenter mode for Human Tracking.

With this setup, the camera first goes to Preset 1 after a speaker starts talking in the presenter area (MIC Channel 1), then the camera tracking (Presenter Mode) will be automatically turned on.

Microphone detects voice

Camera goes to Preset 1

Presenter Tracking



4. Click the **Time** button  to set up how long it takes to trigger a preset or go back to a pre-configured Preset 0 (home position).

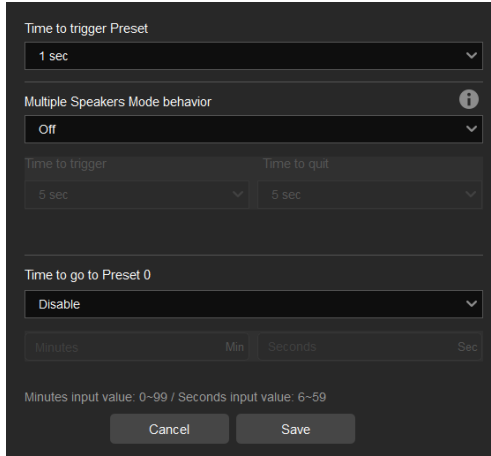

The screenshot shows a settings menu with the following options:

- Time to trigger Preset:** 1 sec
- Multiple Speakers Mode behavior:** Off
- Time to trigger:** 5 sec
- Time to quit:** 5 sec
- Time to go to Preset 0:** Disable

At the bottom, there are input fields for Minutes and Seconds, with a note: "Minutes input value: 0-99 / Seconds input value: 6-59". There are also "Cancel" and "Save" buttons.

Item	Description
Time to trigger Preset	Select how long it takes for the camera to move to a Preset after it detects a sound.
Multiple Speakers Mode behavior	<ul style="list-style-type: none"> Select Back to Preset 0 to enable Multiple Speakers Mode. Multiple Speakers Mode will be triggered when the camera has been ping-ponging between sound sources 3 times. The camera will return to Preset 0 to minimize disorienting movements. The length of Time to trigger and Time to quit must be 3 times the length of Time to trigger Preset.
Time to go to Preset 0	Enter how long it takes for the camera to move to Preset 0 after it detects no sound.

5. The pair-up configuration is completed. When voices are detected, the voice tracking  icons will appear next to the channels. The Channel in blue indicates that the camera is staying at its preset point.

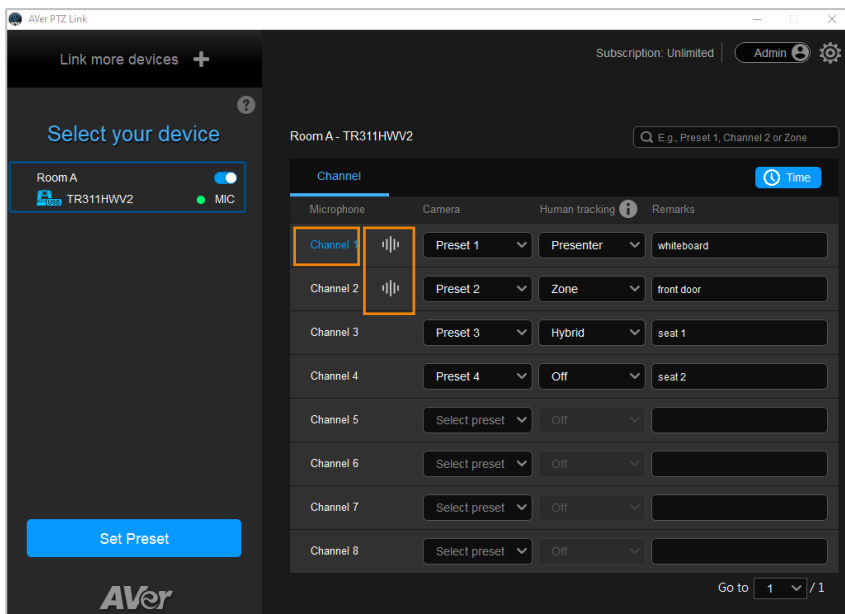

Active Position Setup

Active Position setup is another method to achieve the Voice Tracking function. Compare with **Channel** setup, **Active Position** setup is a more accurate way to direct the camera to move to the position of the sound. When microphone detects sound, it will transfer the 3-axis coordinates (X, Y, Z) of the sound to the camera, and the camera will move to the position accordingly.

The Active Position setup only supports Virtual Cameras (USB). At present, only the Shure MXA920 microphone is supported.

[Note] The Shure MXA920 microphones support both Channel setup and Active Position setup for voice tracking.

- For Channel setup, optionally configure the Channel setting on the Web page of the microphone.
- For Active Position setup, optionally configure the Coverage setting on the Web page of the microphone.

To set up Active Position, please follow the steps below.

1. Ensure the USB cameras have been bound to a Shure MXA920 microphone.
2. Select an USB camera on the Device List by clicking on it. The selected device will be highlighted with a blue frame.

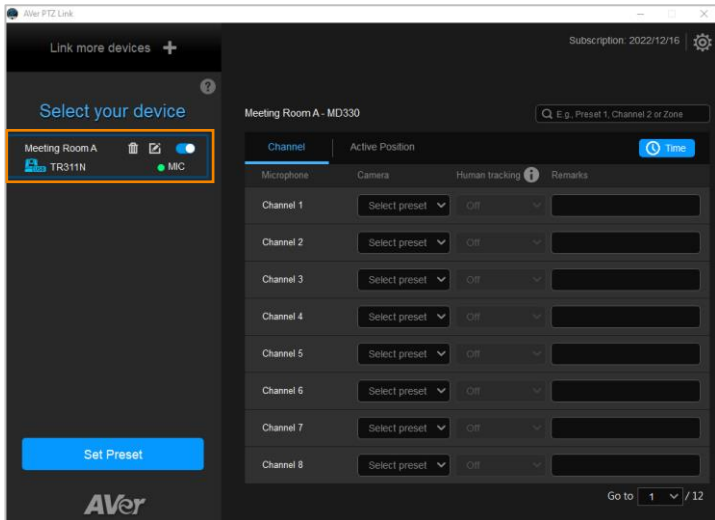

- On the right-side panel, click the **Active Position** tab. For first-time setup, you will be prompted with a setup wizard to calibrate the camera and microphone. Follow the steps as instructed.

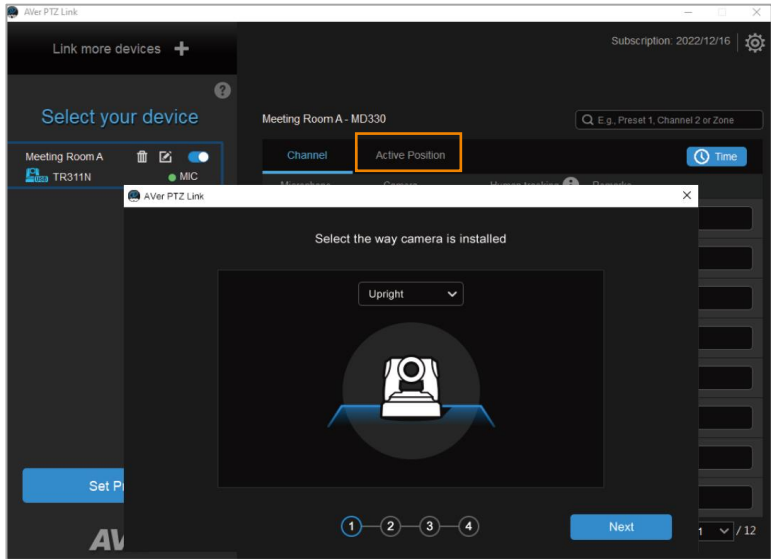

Step 1: Select the way camera is installed.

Select a camera installation option from the drop-down list. Click “Next”.

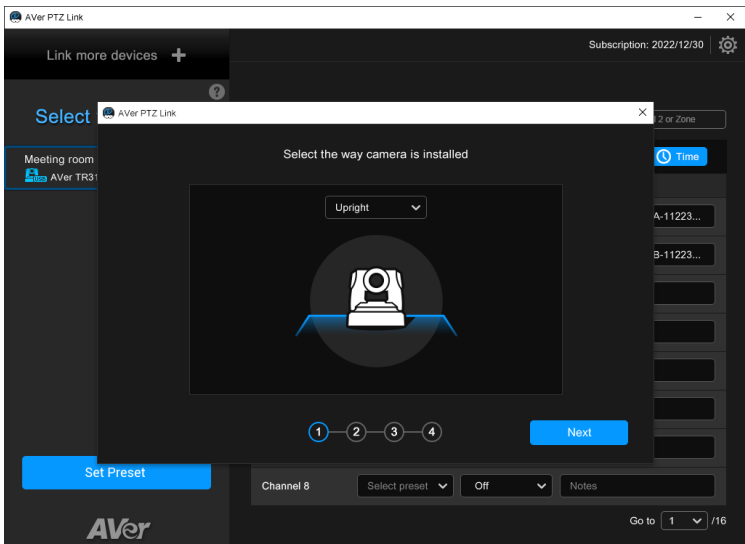

Step 2: Calibrate the camera and microphone.

Use the red horizontal line to calibrate the camera and microphone. You can also click the  button to display more info of calibration setup.

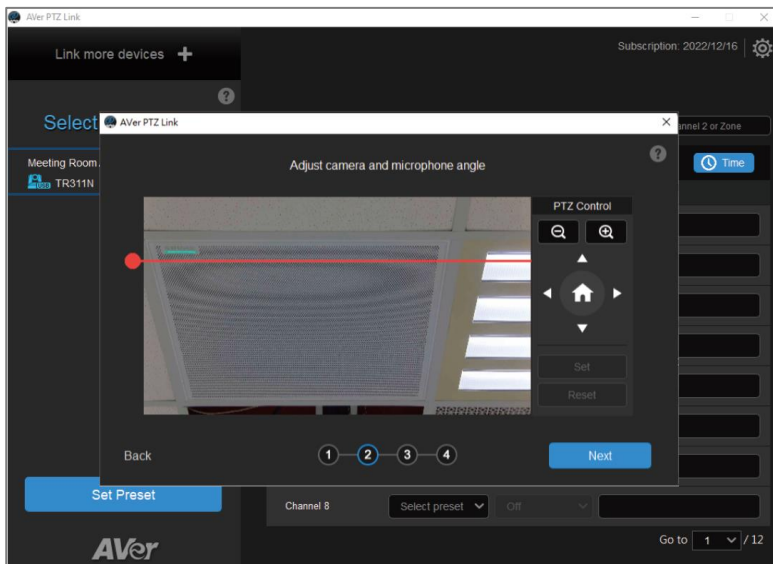

- a. Click on the red circle of the red line and drag it to align it with either edge (top or bottom) of the microphone horizontally.

You can optimize the angle of the camera feed by using the pan, tilt and zoom buttons on the PTZ Control panel during the alignment process.

The zoom buttons on this panel is only for calibration. Adjusting the zoom level here will not affect the final zoom ratio of the camera.

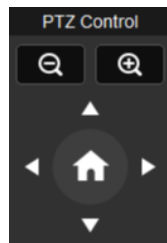

Make sure the red line is aligned with the top or bottom edge of the microphone horizontally.

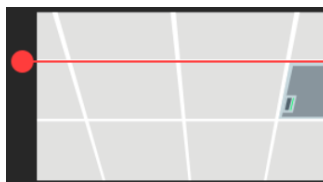
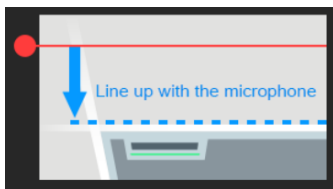

[Note]

- If the microphone shows up at a slight angle in the camera feed, use the pan, tilt and zoom buttons on the PTZ Control panel to optimize camera position.
 - As long as the red horizontal line is aligned with the edge of the microphone, there's no need for the microphone to be displayed in the center of the camera feed.
- b. When the calibration is done, click “Next” to proceed.

Step 3: Microphone positioning.

Locate 3 corners of the microphone and the corner of the logo. When the setting is done, click “Next”.

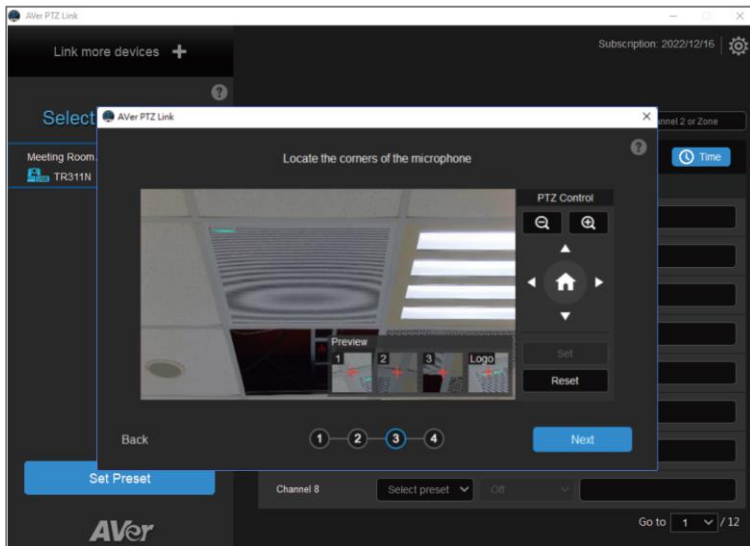

- a. Locate 3 corners: The 3 corners of the microphone have to be configured in clockwise order from upper left, upper right and lower right. You can use the buttons on the PTZ Control panel to move the red cross-mark on the preview window to the corners and then click the “Set” button to save the corner setting.
- To set up the 1st (upper left) corner, use the PTZ Control panel to move the red cross-mark to the upper left corner of the microphone. Click “Set”, the 1st corner will be set up and you can see a thumbnail of the upper left

corner in the Preview window. Follow this step to setup the 2nd (upper right) and 3rd (lower right) corners.

- b. Locate the corner of the logo: Use the PTZ Control panel to move the red cross-mark to the corner of the logo on the microphone. Click “Set”, the corner of the logo will be set up and you can see a thumbnail of the logo corner in the Preview window.
- c. When the setting is done, click “Next”. If you want to change the settings, click the “Reset” button on the PTZ Control panel to reset the corners.

You can also click the  button to display more info of corner setup.

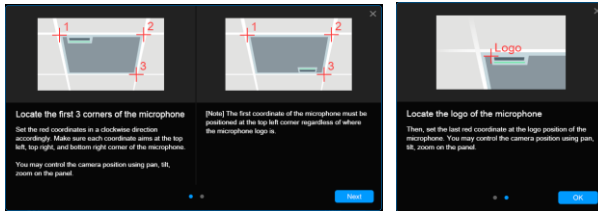

Step 4: Finalize the calibration.

Check whether the red cross-mark is located in the middle of the microphone. If the setup is fine, click “Save”. If you want to re-configure the setting, click “Back” to reset the settings.

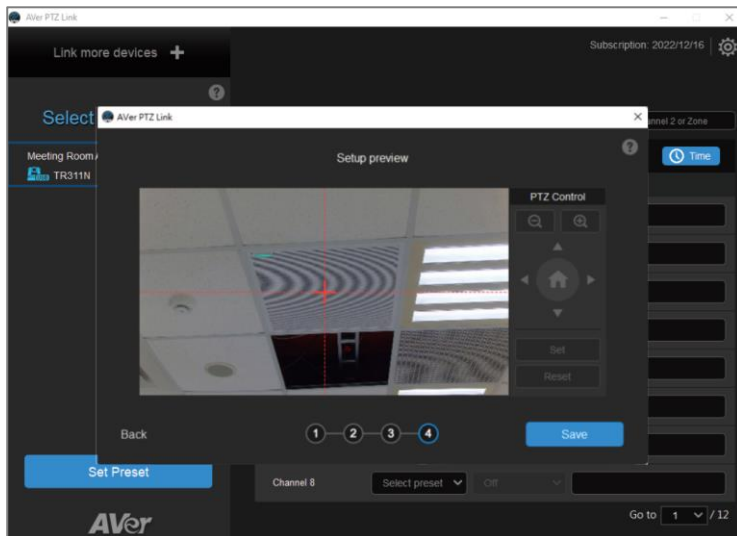

4. After completing camera and microphone calibration, you can optionally assign a pre-configured **Coverage** area of the microphone to the camera. The coverage areas have to be pre-configured on the microphone side.

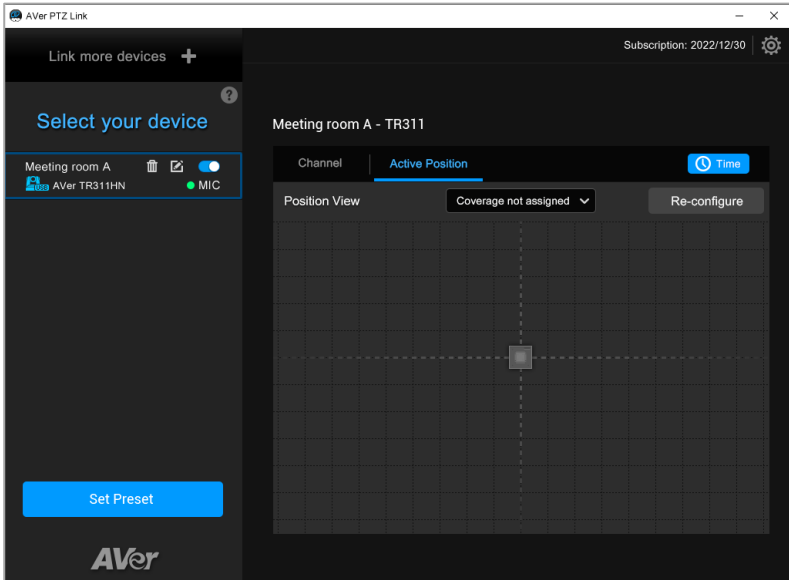

- a. On the Shure setup page, optionally configure the **Coverage** areas. The default Coverage is illustrated as below.

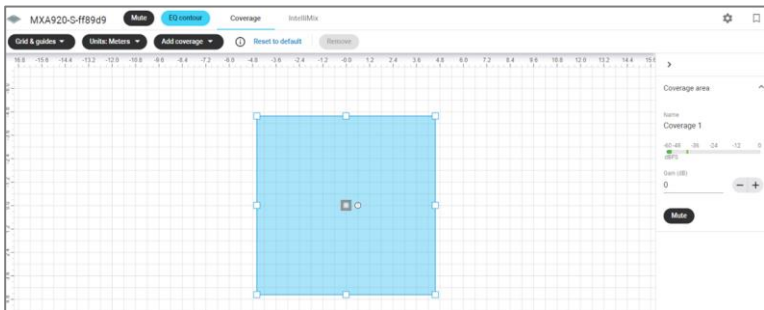

- b. On the **Active Position** setup page, select a pre-configured **Coverage** from the drop-down list. If there is no Coverage area configured on the microphone side, the PTZ Link program will get the default Coverage setting from the microphone.

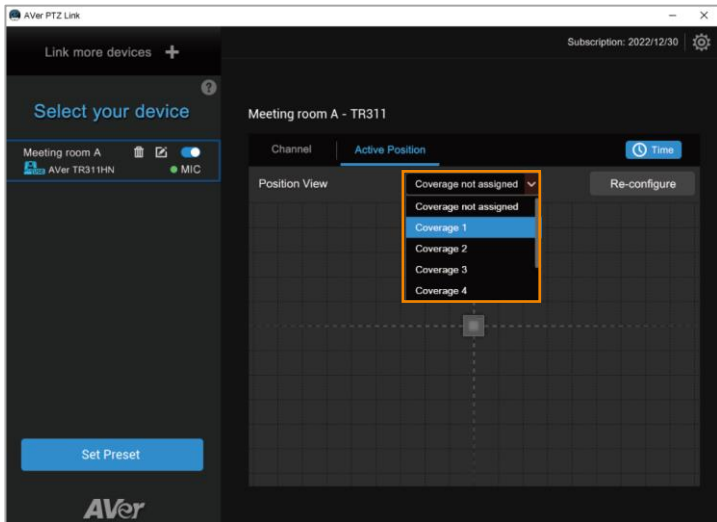

- c. The detected sound will be displayed as a green dot on the Position View and its coordinates will be displayed on the lower right corner. The coordinates within the coverage will be transferred to the camera and the camera will move to the position accordingly.

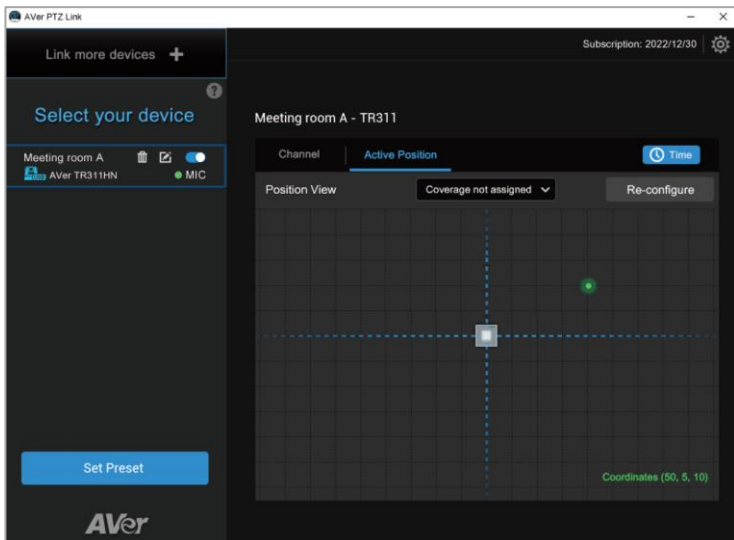

- d. If you want to reset the setting, click the “Re-configure” button.
5. The Active Position setup is completed.

AVer PTZ Link Information

Configure PTZ Link settings.

On the PTZ Link main page, click the settings icon  to display **AVer PTZ Link Information**.

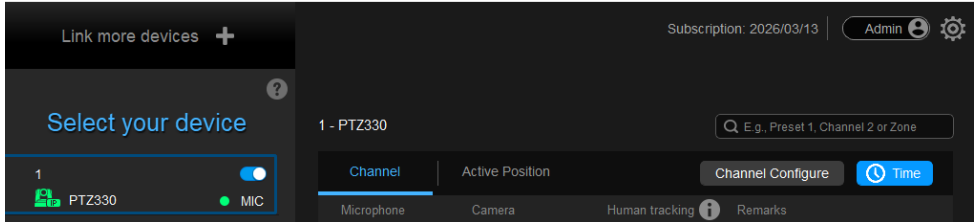



The screenshot shows the AVer PTZ Link settings interface. At the top left, there is a button labeled "Link more devices" with a plus sign. Below it, a section titled "Select your device" contains a list of devices. The first device, labeled "1", is "PTZ330" and has a blue toggle switch turned on and a green "MIC" indicator. To the right of the device list, the text "1 - PTZ330" is displayed. Further right, there is a search bar with the placeholder text "E.g., Preset 1, Channel 2 or Zone". Below the search bar, there are two tabs: "Channel" (which is active) and "Active Position". To the right of these tabs are two buttons: "Channel Configure" and "Time". At the bottom of the interface, there are several menu items: "Microphone", "Camera", "Human tracking" (with an information icon), and "Remarks". In the top right corner, there is a "Subscription: 2026/03/13" label and an "Admin" button with a user icon and a settings gear icon.

System

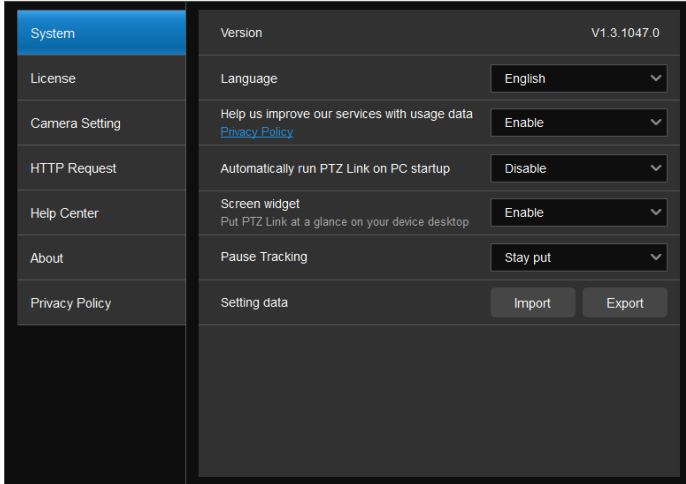
View system version, change system language, disable usage data or set up PTZ Link to automatically run at startup, as well as import or export PTZ Link data, and enable screen widget to quickly enable or disable groups on the device list.



Item	Description
Version	Displays system version.
Language	Select a preferred language.
Help us improve our services with usage data	Opt-in to or Opt-out of providing usage data.
Automatically run PTZ Link on PC startup	Add PTZ Link to run at startup.
Screen widget	<ul style="list-style-type: none">• Enable or disable a floating window when minimizing PTZ Link.•  Disable all devices on the device list. Set the camera's pause position in Pause Tracking.•  Enable all devices on the device list.•  Maximize PTZ Link.• The screen widget also works in Zoom.
Pause tracking	Select if a camera stays at the last position or return to Preset 0 when tracking is paused.

Item	Description
Setting data	Export or import device settings such as camera-microphone pairs, presets, and channels when changing computers. This data doesn't include license information.

License

You can use this page to activate your premium license for Virtual Camera connection and up to 128 microphone channels; or start a 60-day free trial. One license key can only be activated on one computer.

To enter this page, on the PTZ Link main page, click  to display the AVer PTZ Link Information page and then click **License**.

[Note] Since one license key can only be activated on one computer. If you want to transfer the license key to a new computer, you will need to deactivate the license key from the original computer and then activate it on the new computer. For license deactivation, please refer to **To deactivate the license key**.

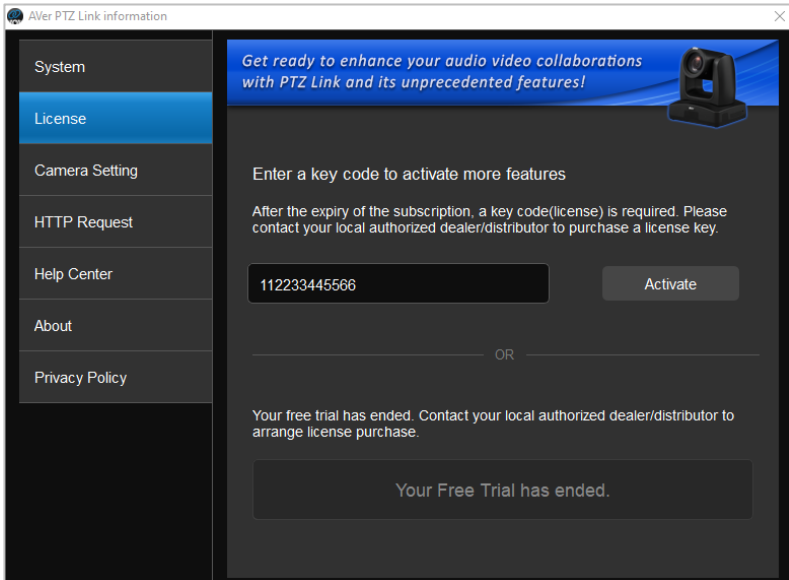

To activate the license key:

1. On the AVer PTZ Link Information page, click **License** to enter the License page. Input the license key in the input box.

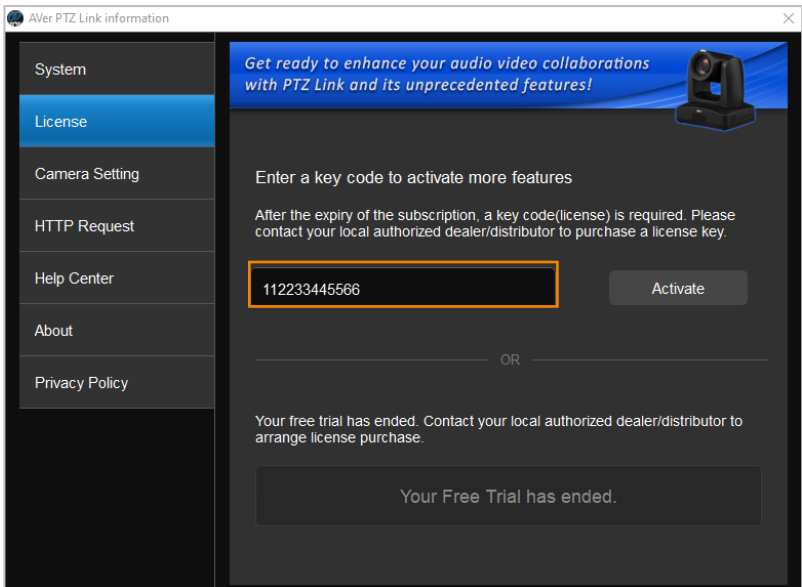

2. Click **Activate**, the below message window appears. Click **Yes, start Subscription directly**.

[Note] You will waive your free trial if you subscribe your license key. If you have started the Free Trial, subscribing the license key will immediately activate the premium version without including the remaining days of the trial period. In such case, you can click **No, start Free Trial first** to wait until the trial period expires.

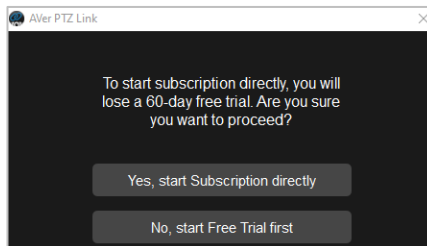

3. Click **Continue** to start activating the license key.

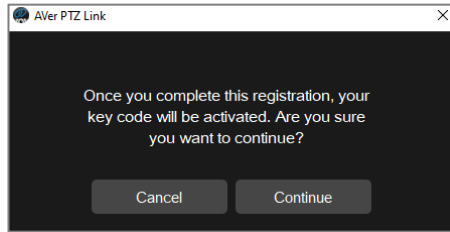

4. Input your email and organization information for subscription.

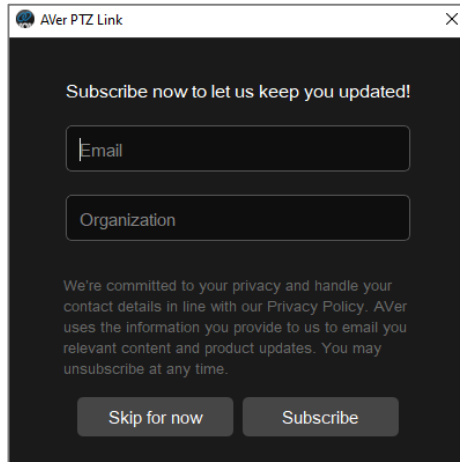

5. The activation is completed.

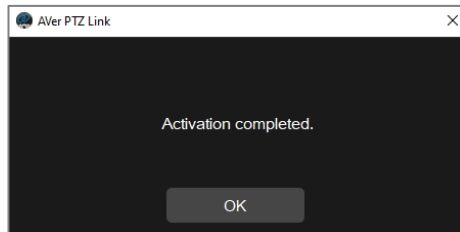

6. The license info will be displayed.

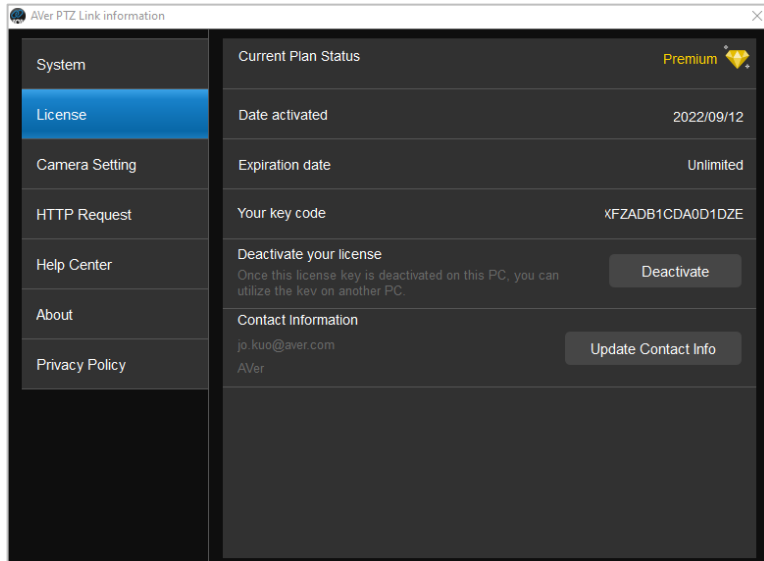

The expiration date will also be displayed on the upper-right corner of the Main Page.

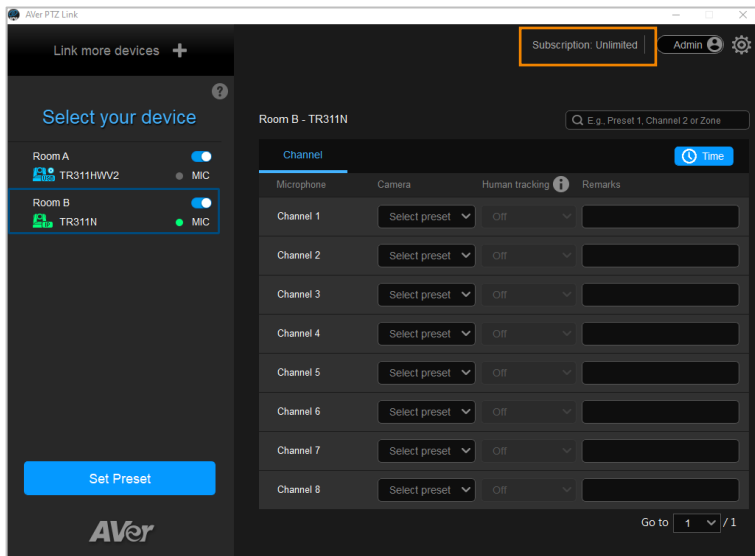

To deactivate the license key:

One license key can only be activated on one computer. If you want to transfer the license key to a new computer, you will need to deactivate the license key from the original computer and then activate it on the new computer. The expiration date of the license key will remain the same.

1. On the AVer PTZ Link Information page, click **License** to enter the License page.

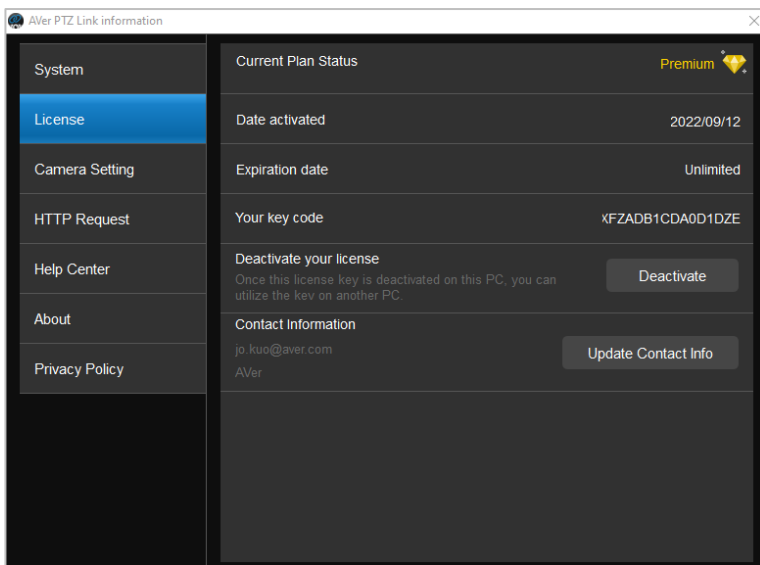

2. In the **Deactivate your license** field, click **Deactivate**, the below message window appears.

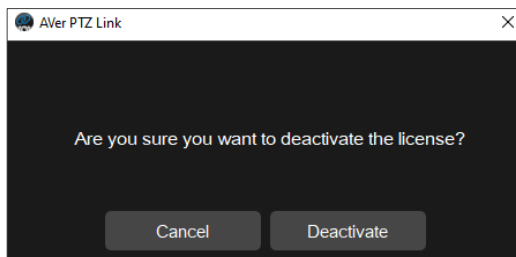

3. Click **Deactivate** and the deactivation process is completed.

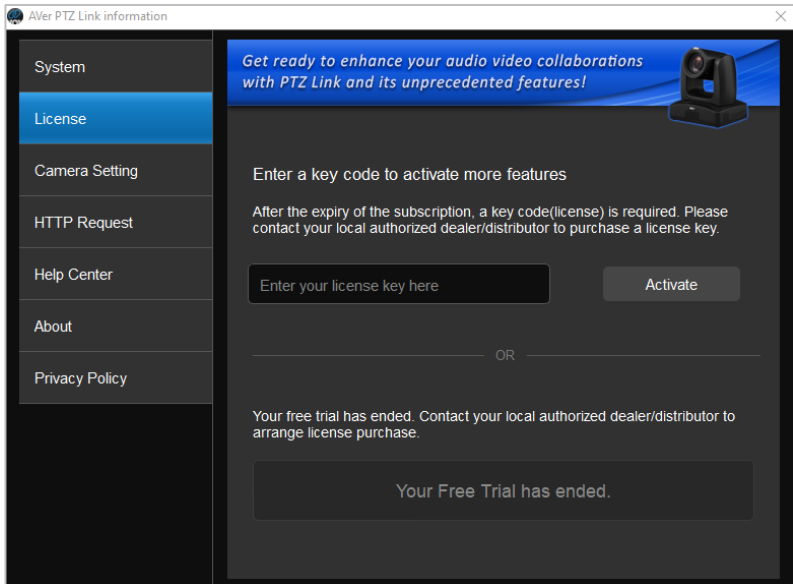

To start a 60-day free trial:

1. On the License page, click **Start Free Trial**.

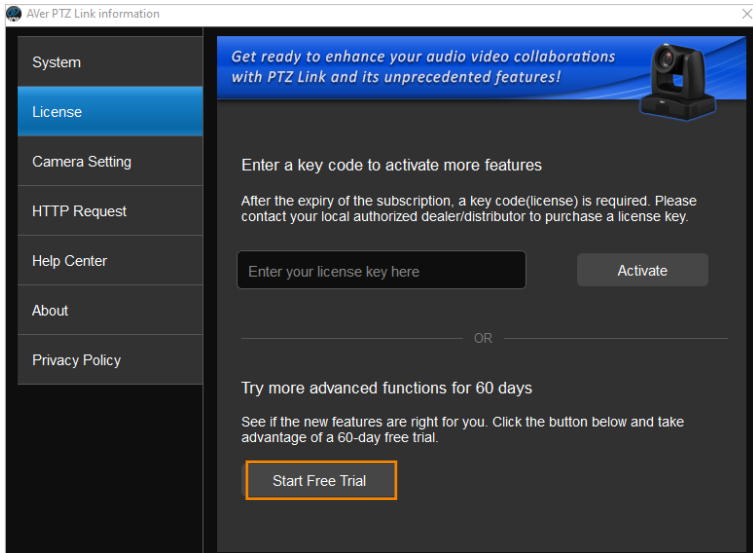

2. Input your email and organization information for subscription. Click **Subscribe**.

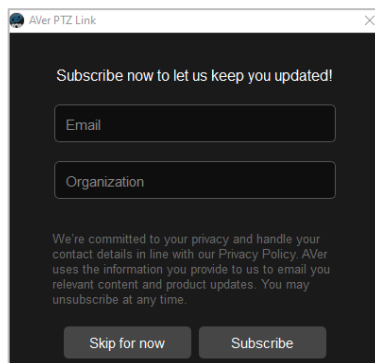

- The free trial will be activated and the expiration date will be displayed.

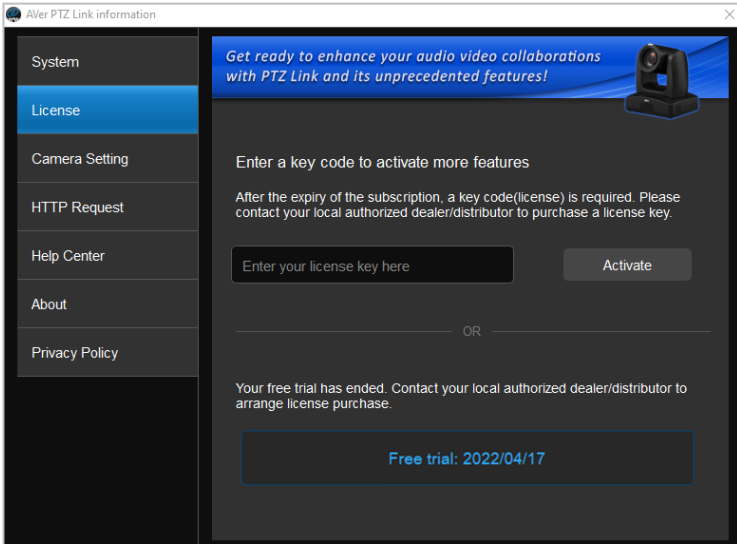

The expiration date will also be displayed on the upper-right corner of the Main Page.

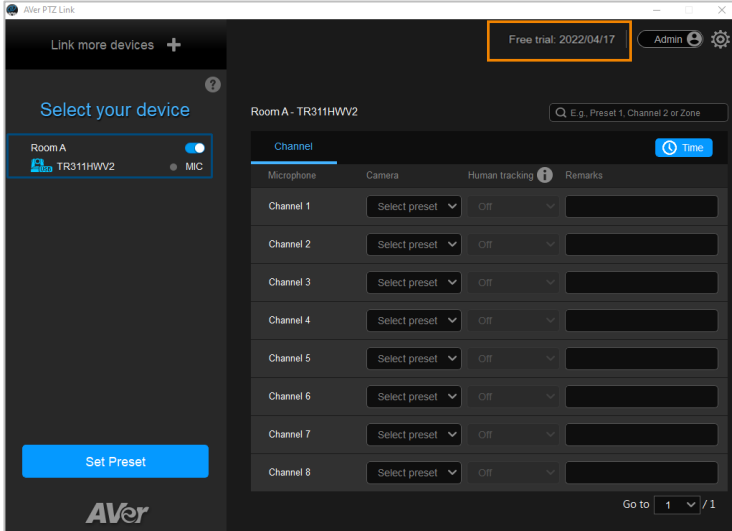

[Note] You will waive your free trial if you subscribe your license key. If you have acquired the license key, however, you are still in the trial period, you can wait until the trial period expires and then activate the license key. Subscribing the license key will immediately activate the premium version without including the remaining days of the trial period.

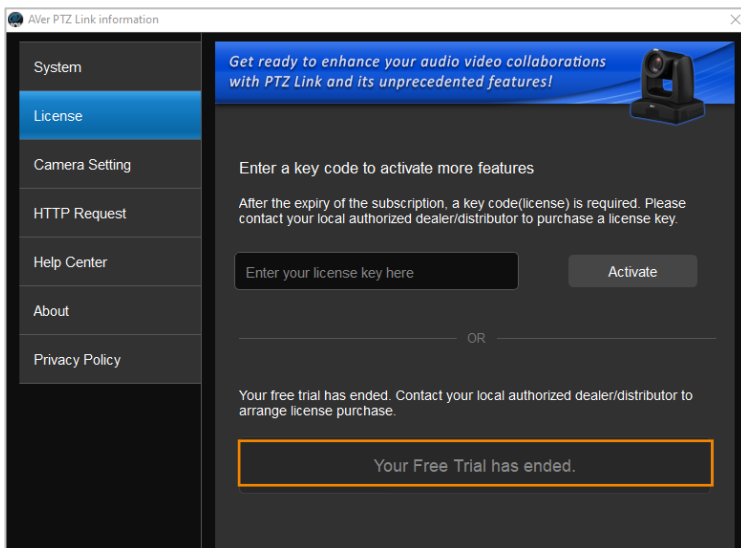

Camera Setting

The settings on this page are only available for the Virtual Cameras (USB). You can select an output layout or mirror the remarks (text overlay).

To enter this page, on the PTZ Link main page, click  to display the AVer PTZ Link Information page and then click **Camera Setting**.

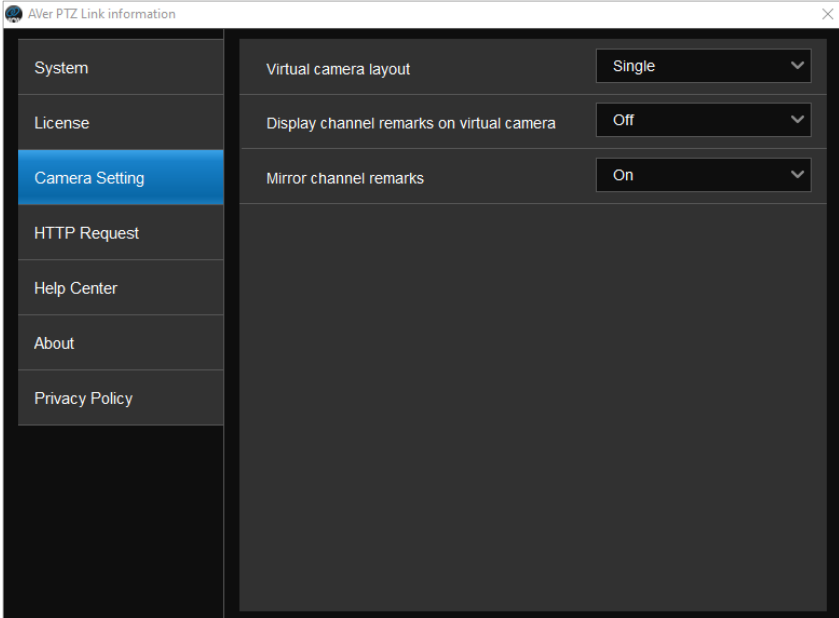

- **Virtual camera layout:** This function is only available for virtual cameras (USB). Select an output layout for the virtual cameras. Options include **Single** and **Side-by-side** (Windows app only).
 - **Single:** When there are multiple virtual camera groups being triggered at the same time, the output layout will display a single camera view, which means only one active speaking participant will be shown at a time.
 - **Side-by-side:** When there are multiple virtual camera groups being triggered at the same time, the output layout will display a side-by-side camera view, which means two active speaking participants will be shown at a time.

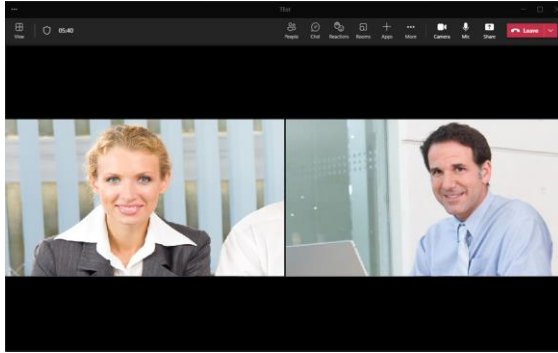

- **Display channel remarks on virtual camera:** This function is only available for virtual cameras (USB). Select **On** or **Off** to enable or disable displaying Remarks (text overlay) on the output of the camera view. To add a remark, input the text in the **Remarks** columns on the Main Page of PTZ Link. Please refer to *Step 3* in <[Pair Up Preset Positions with Microphone](#)>.
- **Mirror channel remarks:** This function is only available for virtual cameras (USB). Select **On** to mirror the Remarks (text overlay) displayed on the output of the camera view.



HTTP Request

HTTP request allows third-party integration and lets you quickly perform various tasks to your groups on the device list.

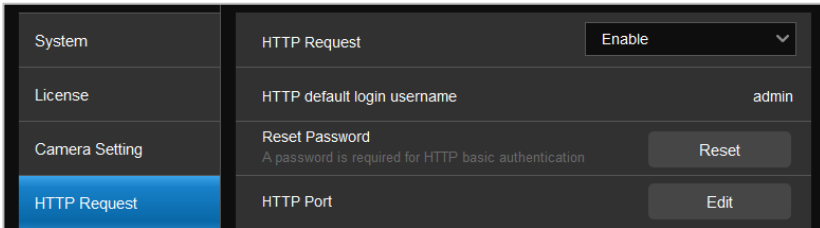

1. On the PTZ Link main page, click the settings icon to display **AVer PTZ Link Information** page, then click **HTTP Request** in the side panel.
2. Set up the HTTP request configuration:
 - Enable **HTTP Request** from the drop-down list.
 - Click **Reset** to set up a password.
 - Click **Edit** to enter a port number
3. To execute HTTP requests, open a request URL.

Example `http://admin:3346@192.168.0.22:80/request=disableAll`

Element `http://[account]:[password]@[IP Address]:[port]/request=disableAll`

An HTTP request contains the following elements:

- Account: HTTP default login username “admin”
- Password: the password you set up in Step 2
- IP Address: IP address of your computer
- Port: the port number you set up in Step 2

4. You can also execute any of the following HTTP requests:

Function	Request
Pause all groups	http://[account]:[password]@[IP Address]:[port]/request=pause
Resume all groups	http://[account]:[password]@[IP Address]:[port]/request=resume
Query pause status of all groups	http://[account]:[password]@[IP Address]:[port]/request=queryPauseStatus
Disable all groups	http://[account]:[password]@[IP Address]:[port]/request=disableAll
Enable all groups	http://[account]:[password]@[IP Address]:[port]/request=enableAll
Disable a specified group	http://[account]:[password]@[IP Address]:[port]/request=disable&group=[Group ID]
Enable a specified group	http://[account]:[password]@[IP Address]:[port]/request=enable&group=[Group ID]
Query status of a specified group	http://[account]:[password]@[IP Address]:[port]/request=queryStatus&group=[Group ID]

Help Center

If you want to download PTZ Link user's manual, click the **Read** button. To enter this page, on the PTZ Link main page, click  to display the AVer PTZ Link Information page and then click **Help Center**.

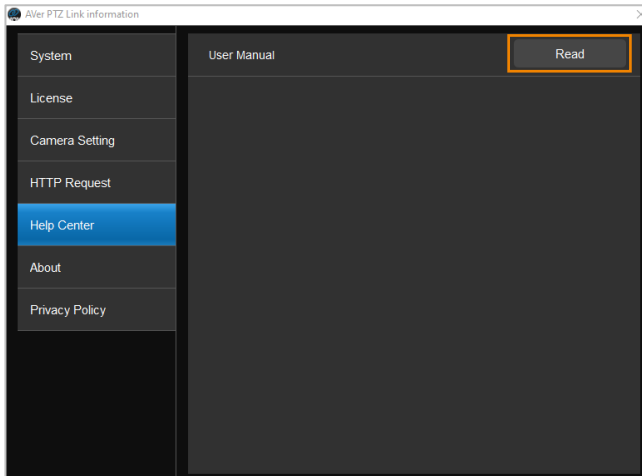

About

You can view the information about AVer PTZ Link on the About page. To enter this page, on the PTZ Link main page, click  to display the AVer PTZ Link Information page and then click **About**.

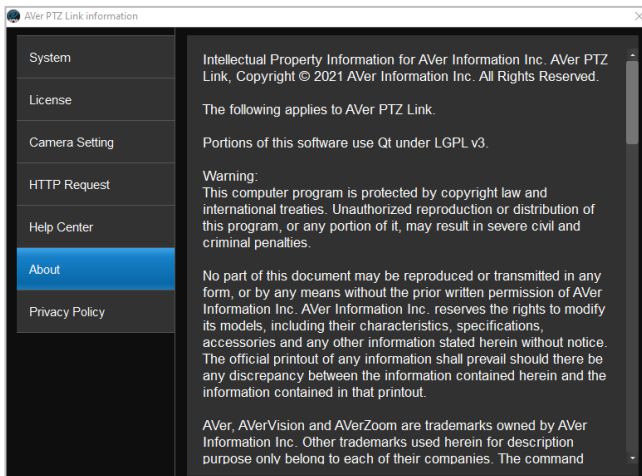

Privacy Policy

You can view the Privacy Policy of AVer PTZ Link. On the PTZ Link main page, click  to display the AVer PTZ Link Information page and then click **Privacy Policy**.

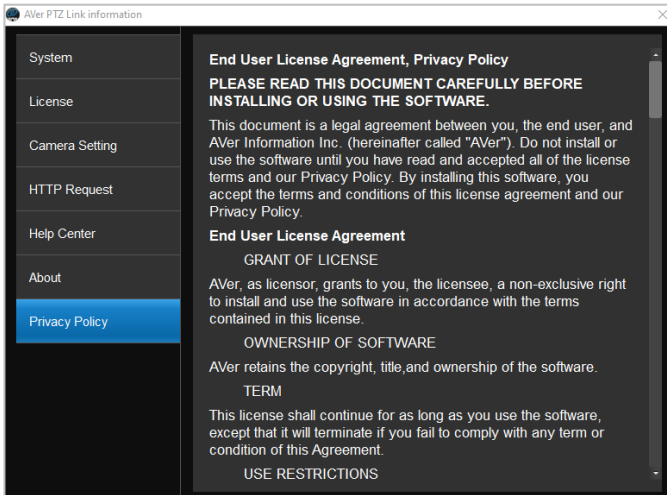

Minimize and Restore AVer PTZ Link

To make voice tracking work during the meeting, AVer PTZ Link must be kept running. User can minimize AVer PTZ Link to system tray to run in background. Click  button to minimize AVer PTZ Link.

[Note] To minimize AVer PTZ Link to the system tray, you will have to disable the **Screen widget** function. Please refer to **Screen widget** in the <[System](#)> chapter.

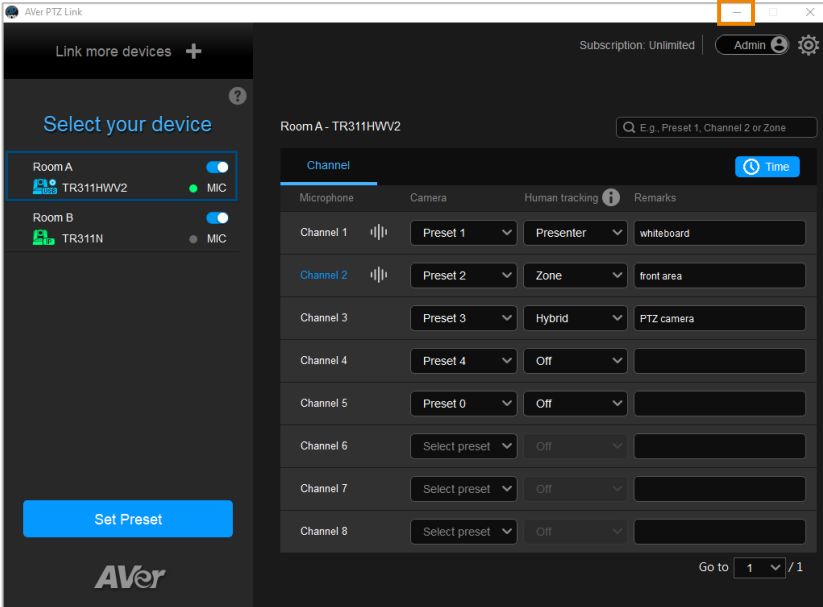

To restore, right-click AVer PTZ Link icon on the system tray and select **Open AVer PTZ Link**.

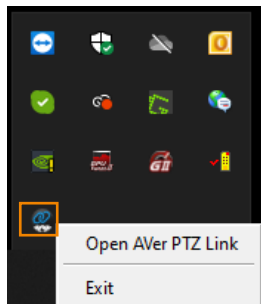

Exit AVer PTZ Link

Click **X** button or right-click AVer PTZ Link icon on the system tray and select **Exit** to exit AVer PTZ Link.

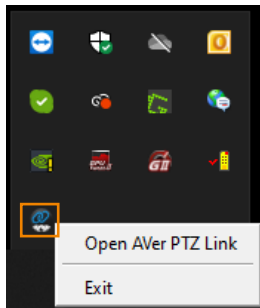
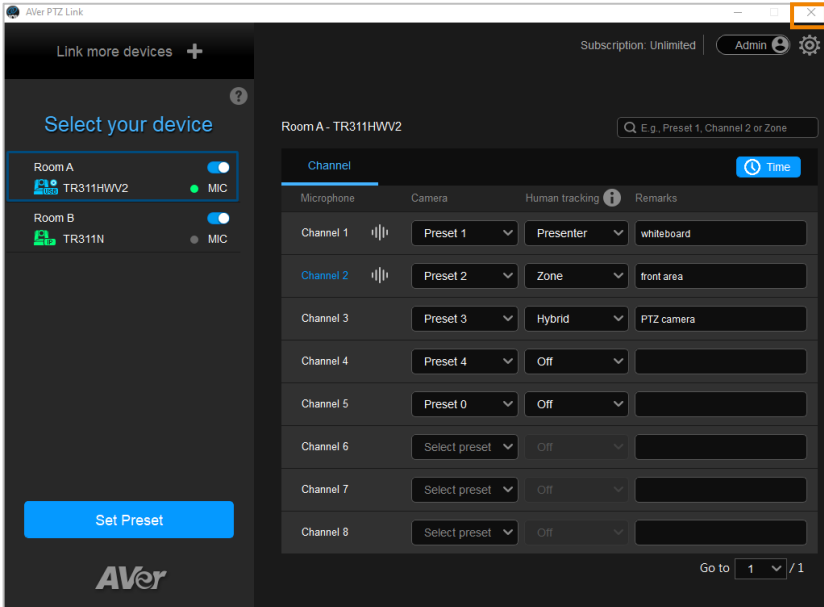

The warning dialog will appear. Your device will be disconnected if you close the software. Click **OK** to exit.

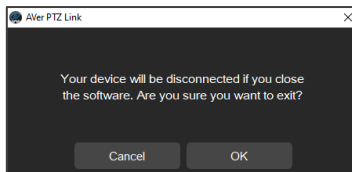

Troubleshooting

1. How to set up multiple cameras or microphones with PTZ Link?
 - You can set up a maximum of 5 groups of devices in PTZ Link. For example, when there are two microphones and one camera in the room, you can set two microphones into two groups accordingly. Each microphone has 8 channels (free version) that can be matched to 8 different preset points of the camera. One AVer camera has up to 256 preset points available. To make sure the audio tracking function is working well, each group has to be enabled and the software has to be running all the time.
2. What microphone brands are supported by PTZ Link?
 - The supported microphone brands and models are listed in the Preface chapter. AVer has been actively developing partnerships with other brands that bring the audio solution. If other microphone integration with AVer Pro AV cameras in your region is needed, please feel free to let us know. You may contact our technical support. Please refer to the Contact Information.
3. How do the Mute functions of Shure microphones work with PTZ Link?
 - If the Mute function of a single channel of the microphone is enabled, the corresponding channel of PTZ Link will not detect the voice.



- If the Mute function is enabled on the webpage of the microphone, it is also required to disable the corresponding device on PTZ Link. Thus, the microphone will not respond in PTZ Link.



4. After the configuration on AVer PTZ Link is completed, I noticed the camera might be too sensitive and keeps shifting to different presets I paired up. Is there anything special I need to do?

- This may have something to do with **Time to trigger Preset**. You can extend **Time to trigger Preset** to solve the problem.

5. When connecting to Sennheiser TeamConnect Ceiling 2 via AVer PTZ Link, I encounter a situation where speakers all around the room are invariably detected. What would you suggest me to do?

- In most meetings and a lot of online classes, conversations go back and forth. Sennheiser TeamConnect Ceiling 2 might pick up speakers' voices from all around the room, causing the camera to go back and forth between different preset points. If such is the case, you can enable the **Priority Zone** of Sennheiser TeamConnect Ceiling 2 so that it only picks up the audio signals of the zone you chose.
- For details on the **Priority Zone** of Sennheiser TeamConnect Ceiling 2, visit:

https://www.sennheiser-sites.com/responsive-manuals/SCC/EN/index.html#page/SCC_EN/SCC_04_EN.5.3.html#ww1106250.

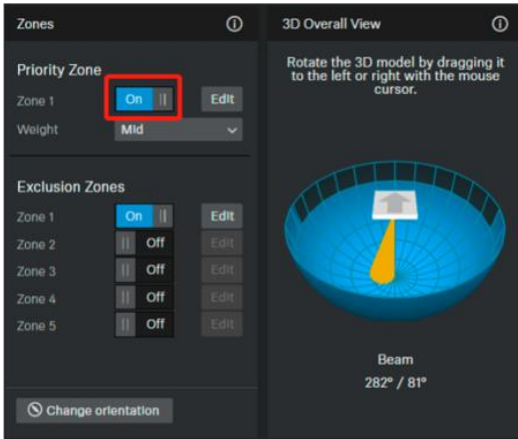

6. What to do if we would like to quickly control voice tracking (e.g. pause voice tracking) when cameras are not in use?
- Solution A: To quickly pause voice tracking, you can mute the microphones to stop transferring sound data to the PTZ Link program. For microphones with physical mute button, directly press the mute button. For microphones without physical mute button, access its Web page to enable the mute function.
 - Solution B: Enable the **Screen widget** function on the PTZ Link. You can use the pause button on the **Screen widget** to disable all the groups added to the device list. When the devices are disabled, the cameras will not be triggered even when microphones continue transmitting sound data. You can also use the resume button on the **Screen widget** to resume all the groups.
- The **Screen widget** also supports Zoom Room. For more details, please refer to **Screen widget** in the [<System>](#) chapter.
7. What to do if the Virtual Camera views cannot be displayed on the video conference software, e.g. Teams?
- When this symptom occurs, please check:
 - a. Is the video source of this camera occupied by another application?
 - b. Launch PTZ Link and check the connection of this camera first. Then, check the video source of this camera on your application.

8. What to do if I don't see the option of AVer Virtual Camera in the video source field of the video conference software (e.g. Teams) after connecting to the Virtual Camera via PTZ Link?
 - Please try restarting the video conference software or restarting the computer.

9. What to do if I can't operate PTZ Link normally during Teams conference?
 - When this symptom occurs, please check:
 - a. The version of Windows[®] OS should be 2004 or above (e.g. 20H2 or 21H2).
 - b. Uninstall the AVerCamera Setting Tool and PTZ Link in your computer.
 - c. Re-install the PTZ Link.

Appendix

AVerCamera Setting Tool

AVerCamera Setting Tool is automatically installed along with PTZ Link. Users can use the AVerCamera Setting Tool to set up preset positions or configure some settings for the Virtual Cameras (USB).



To bring-up the AVerCamera Setting Tool, you can try either way:

- On the Main Page of PTZ Link, select an USB device group on the Device List by clicking on it, and then click the **Set Preset** button.

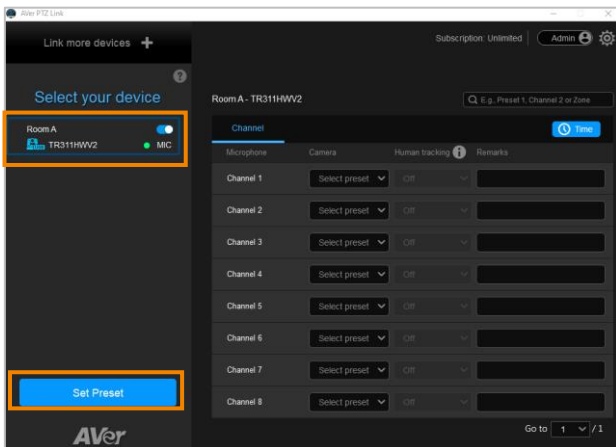

- On your desktop, double-click on the AVerCamera Setting Tool shortcut  .

[Note] Users can also use AVerCamera Setting Tool to control the Virtual Cameras

(USB) used for video conference software such as Zoom or Skype.

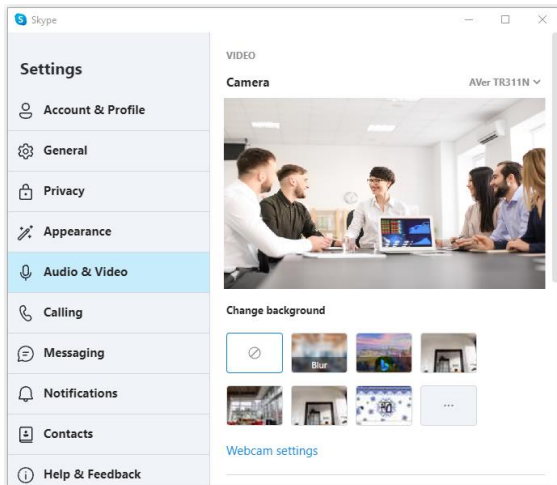
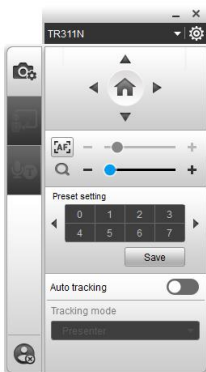

Control Panel

Control panel allows you to control the Virtual Cameras (USB) or set up the preset positions.



Control Panel

Camera View

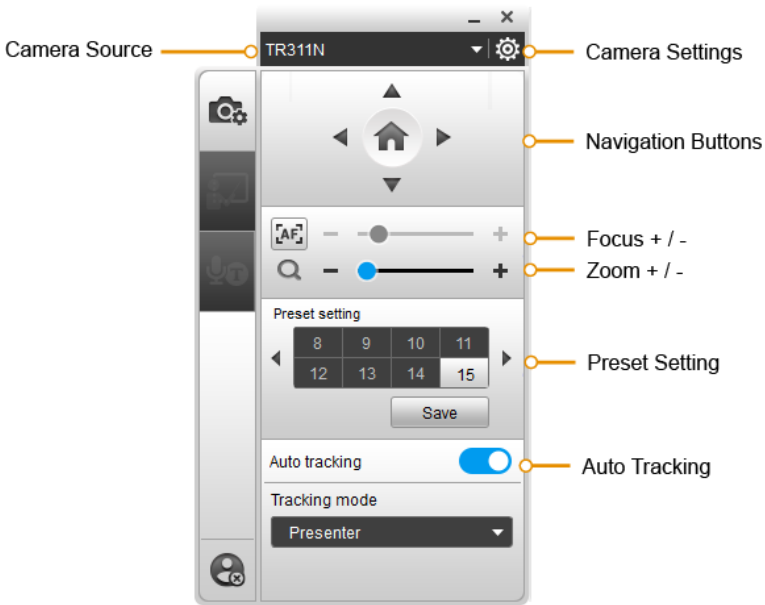

Camera Source

After connecting the Virtual Cameras (USB) to your computer, the cameras will be automatically listed on Camera Source. Click on the Camera Source to select a Virtual Camera from the drop-down list.

Camera Settings

Select a Virtual Camera (USB) from the Camera Source list and then click on the  icon to configure some camera settings.

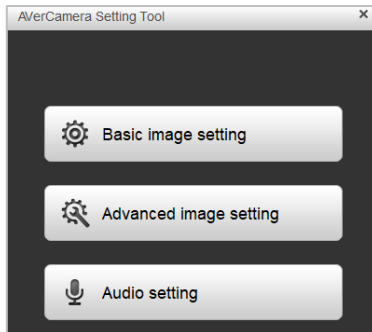



Navigation Buttons

Select a Virtual Camera (USB) from the Camera Source list and then you can use the up, down, left or right buttons to navigate the camera view.

Click the Home button  in the middle can direct the camera to the home position.

Focus / Zoom

Select a Virtual Camera (USB) from the Camera Source list and then you can use the Zoom +/- buttons to adjust the zoom ratio.

To adjust focus, you can click on the Focus icon to switch between Auto Focus  and Manual Focus . Select Auto Focus, the camera will automatically adjust focus. Select Manual Focus, and then you can use the + or – button to manually adjust focus.

Preset Setting

Select a Virtual Camera (USB) from the Camera Source list and then you can configure preset positions for this camera. Up to 256 (0~255) preset positions are supported. To setup preset position:

1. Click on a number.
2. Use the navigation and zoom buttons to adjust the camera view to a desired position.
3. Click the **Save** button. The preset position has been saved.
4. To perform the go to Preset function, simply click on the configured Preset number, the camera will move to the preset position.

Auto Tracking

To enable the Auto Tracking function, select a Virtual Camera (USB) from the Camera Source list and then toggle on the switch. You can switch among the tracking modes by clicking on the **Tracking mode** drop-down list.

[Note] For this function to work, users have to configure the Tracking modes in advance. Please refer to the user's manual of your camera to set up the Tracking modes.