

Acer Projector

H6800/E8600/HE-4K10/GM820/
VH-720/H6800BD+/H6800ABD/
H6800BD/H6800a/X6800/X6800a/
H6801BDa/H6800BDa/D4K2002/
H6805BDa/E8605/X6810/H6805BD/
H6807BDa/H6815BDa/H6816ABD/
P5827a/M811/N388a/X1827/
H6805ATV/H6815P/H6815ATV/
H6816ATV/E8615P/HE-4K15P

User's Guide

Changes may be made periodically to the information in this publication without obligation to notify any person of such revisions or changes. Such changes will be incorporated in new editions of this manual or supplementary documents and publications. This company makes no representations or warranties, either expressed or implied, with respect to the contents hereof and specifically disclaims the implied warranties of merchantability or fitness for a particular purpose.

Record the model number, serial number, purchase date and place of purchase information in the space provided below. The serial number and model number are recorded on the label affixed to your projector. All correspondence concerning your unit should include the serial number, model number and purchase information.

No part of this publication may be reproduced, stored in a retrieval system, or transmitted, in any form or by any means, electronically, mechanically, by photocopy, recording or otherwise, without the prior written permission of Acer Incorporated.

Model number: _____

Serial number: _____

Date of purchase: _____

Place of purchase: _____

Acer and the Acer logo are registered trademarks of Acer Incorporated. Other companies' product names or trademarks are used herein for identification purposes only and belong to their respective companies.

"HDMI™, the HDMI logo and High-Definition Multimedia Interface are trademarks or registered trademarks of HDMI Licensing LLC."



Information for your safety and comfort

Read these instructions carefully. Keep this document for future reference. Follow all warnings and instructions marked on the product.

Turning the product off before cleaning

Unplug this product from the wall outlet before cleaning. Do not use liquid cleaners or aerosol cleaners. Use a damp cloth for cleaning.

Caution for plug as disconnecting device

Observe the following guidelines when connecting and disconnecting power to the external power supply unit:

- Install the power supply unit before connecting the power cord to the AC power outlet.
- Unplug the power cord before removing the power supply unit from the projector.
- If the system has multiple sources of power, disconnect power from the system by unplugging all power cords from the power supplies.

Caution for Accessibility

Be sure that the power outlet you plug the power cord into is easily accessible and located as close to the equipment operator as possible. When you need to disconnect power to the equipment, be sure to unplug the power cord from the electrical outlet.



Warnings!

- Do not use this product near water.
- Do not place this product on an unstable cart, stand or table. If the product falls, it could be seriously damaged.
- Slots and openings are provided for ventilation to ensure reliable operation of the product and to protect it from overheating. These openings must not be blocked or covered. The openings should never be blocked by placing the product on a bed, sofa, rug or other similar surface.
- This product should never be placed near or over a radiator or heat register, or in a built-in installation unless proper ventilation is provided.
- Never push objects of any kind into this product through cabinet slots as they may touch dangerous voltage points or short-out parts that could result in a fire or electric shock. Never spill liquid of any kind onto or into the product.
- To avoid damage of internal components and to prevent battery leakage, do not place the product on a vibrating surface.

- Never use it under sporting, exercising, or any vibrating environment which will probably cause unexpected short current or damage rotor devices, lamp.

Using electrical power

- This product should be operated from the type of power indicated on the marking label. If you are not sure of the type of power available, consult your dealer or local power company.
- Do not allow anything to rest on the power cord. Do not locate this product where people will walk on the cord.
- If an extension cord is used with this product, make sure that the total ampere rating of the equipment plugged into the extension cord does not exceed the extension cord ampere rating. Also, make sure that the total rating of all products plugged into the wall outlet does not exceed the fuse rating.
- Do not overload a power outlet, strip or receptacle by plugging in too many devices. The overall system load must not exceed 80% of the branch circuit rating. If power strips are used, the load should not exceed 80% of the power strip's input rating.
- This product's AC adapter is equipped with a three-wire grounded plug. The plug only fits in a grounded power outlet. Make sure the power outlet is properly grounded before inserting the AC adapter plug. Do not insert the plug into a non-grounded power outlet. Contact your electrician for details.



.....
Warning! The grounding pin is a safety feature. Using a power outlet that is not properly grounded may result in electric shock and/or injury.



.....
Note: The grounding pin also provides good protection from unexpected noise produced by other nearby electrical devices that may interfere with the performance of this product.

- Use the product only with the supplied power supply cord set. If you need to replace the power cord set, make sure that the new power cord meets the following requirements: detachable type, UL listed/CSA certified, VDE approved or its equivalent, 4.5 meters (15 feet) maximum length.

Product servicing

Do not attempt to service this product yourself, as opening or removing covers may expose you to dangerous voltage points or other risks. Refer all servicing to qualified service personnel.

Unplug this product from the wall outlet and refer servicing to qualified service personnel when:

- the power cord or plug is damaged, cut or frayed

- liquid was spilled into the product
- the product was exposed to rain or water
- the product has been dropped or the case has been damaged
- the product exhibits a distinct change in performance, indicating a need for service
- the product does not operate normally after following the operating instructions



.....

Note: Adjust only those controls that are covered by the operating instructions, since improper adjustment of other controls may result in damage and will often require extensive work by a qualified technician to restore the product to normal condition.



.....

Warning! For safety reasons, do not use non-compliant parts when adding or changing components. Consult your reseller for purchase options.

Your device and its enhancements may contain small parts. Keep them out of the reach of small children.

Additional safety information

- Do not look into the projector's lens when the lamp is on. The bright may hurt your eyes.
- Turn on the projector first and then signal sources
- Do not place the product in following environments:
 - Space that is poorly ventilated or confined. At least 50cm clearance from walls and free flow of air around the projector is necessary.
 - Locations where temperatures may become excessively high, such as inside of a car with all windows rolled up.
 - Locations where excessive humidity, dust, or cigarette smoke may contaminate optical components, shortening the life span and darkening the image.
 - Locations near fire alarms.
 - Locations with an ambient temperature above 40 °C/104 °F.
 - Locations where the altitudes are higher than 10000 feet.
- Unplug immediately if there is something wrong with your projector. Do not operate if smoke, strange noise or odor comes out of your projector. It might cause fire or electric shock. In this case, unplug immediately and contact your dealer.
- Do not keep using this product to break or drop it. In this case contact your dealer for inspection.
- Do not face the projector lens to the sun. It can lead to fire.
- When switching the projector off, suggest to ensure the projector completes its cooling cycle before disconnecting power.
- Do not frequently turn off the main power abruptly or unplug the projector during operation. The best way is to wait for the fan to turn off before turning main power off.

- Do not touch air outlet grille and bottom plate which becomes hot.
- Clean the air filter frequently if have. The temperature inside may rise and cause damage when the filter/ventilation slots clogged with dirt or dust.
- Do not look into the air outlet grille when projector is operating. It may hurt your eyes.
- Always open the lens shutter or remove the lens cap when the projector is on.
- Do not block the projector lens with any object when the projector is under operation as this could cause the object to become heated and deformed or even cause a fire. To temporarily turn off the lamp, press **HIDE** on the remote control.
- The lamp becomes extremely hot during operation. Allow the projector to cool for approximately 45 minutes prior to removing the lamp assembly for replacement.
- Do not operate lamps beyond the rated lamp life. It could cause it to break on rare occasions.
- Never replace the lamp assembly or any electronic components unless the projector is unplugged.
- The product will detect the life of the lamp itself. Please be sure to change the lamp when is showing warning message.
- When changing the lamp, please allow unit to cool down, and follow all changing instructions.
- Reset the "Lamp Hour Reset" function from the Onscreen display "Management" menu after replacing the lamp module.
- Do not attempt to disassemble this projector. There are dangerous high voltages inside which may hurt you. The only user serviceable part is the lamp which has its own removable cover. Refer servicing only to suitable qualified professional service personnel.
- Do not stand the projector on end vertically. It may cause the projector to fall over, causing injury or damage.
- This product is capable of displaying inverted images for ceiling mount installation. Only use acer ceiling mount kit for mounting the projector and ensure it is securely installed.
- The projector should be placed in a horizontal way by means of desktop or ceiling mount mode only, and its tilt angles should not exceed 6 degrees, otherwise it would cause dramatical decrease of lamp life or severe safety concern of system malfunction.

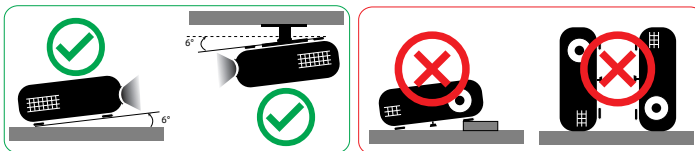

Caution for Listening

To protect your hearing, follow these instructions.

- Increase the volume gradually until you can hear clearly and comfortably.
- Do not increase the volume level after your ears have adjusted.
- Do not listen to music at high volumes for extended periods.
- Do not increase the volume to block out noisy surroundings.
- Decrease the volume if you can't hear people speaking near you.

Disposal instructions

Do not throw this electronic device into the trash when discarding. To minimize pollution and ensure utmost protection of the global environment, please recycle. For more information on the Waste from Electrical and Electronics Equipment (WEEE) regulations, visit

<http://www.acer-group.com/public/Sustainability/sustainability01.htm>



Mercury advisory

For projectors or electronic products containing an LCD/CRT monitor or display:

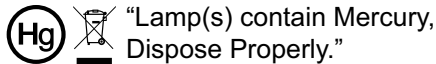

Lamp(s) inside this product contain mercury and must be recycled or disposed of according to local, state or federal laws. For more information, contact the Electronic Industries Alliance at www.eiae.org. For lamp-specific disposal information, check www.lamprecycle.org



Do not stare into the beam, RG2

"As with any bright source, do not stare into the direct beam, RG2 IEC 62471-5:2015"

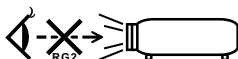

First things first

Usage Notes

Do:

- Please plug in the UWA5 wireless dongle in the Wireless Kit port before opening the projector for the first time.
- If user open the projector first, then plug in the UWA5 wireless dongle, please re-start your projector.
- Turn off the product before cleaning.
- Use a soft cloth moistened with mild detergent to clean the display housing.
- Disconnect the power plug from AC outlet if the product is not being used for a long period of time.

Don't:

- Block the slots and openings on the unit provided for ventilation.
- Use abrasive cleaners, waxes or solvents to clean the unit.
- Use under the following conditions:
 - In extremely hot, cold or humid environments.
 - In areas susceptible to excessive dust and dirt.
 - Near any appliance that generates a strong magnetic field.
 - Place In direct sunlight.

Precautions

Follow all warnings, precautions and maintenance as recommended in this user's guide to maximize the life of your unit.



Warning:

- Do not look into the projector's lens when the lamp is on. The bright light may hurt your eyes.
- To reduce the risk of fire or electric shock, do not expose this product to rain or moisture.
- Please do not open or disassemble the product as this may cause electric shock.
- When changing the lamp, please allow unit to cool down, and follow all changing instructions.
- This product will detect the life of the lamp itself. Please be sure to change the lamp when it shows warning messages.
- Reset the "Lamp Hour Reset" function from the Onscreen display "Management" menu after replacing the lamp module.
- When switching the projector off, please ensure the projector completes its cooling cycle before disconnecting power.
- Turn on the projector first and then the signal sources.

- Do not use lens cap when projector is in operation.
- When the lamp reaches the end of its life, it will burn out and may make a loud popping sound. If this happens, the projector will not turn back on until the lamp module has been replaced. To replace the lamp, contact your local dealer or Acer service center.

Cleaning the lens

- Before cleaning the lens, be sure to turn off the projector and unplug the power cord to allow the projector to cool down for at least 30 minutes.
- Use a compressed air tank to remove the dust.
- Use a special cloth for cleaning lens and gently wipe the lens. Do not touch the lens with your fingers.
- Do not use alkaline/acid detergents or volatile solvents such as alcohol for cleaning lens. If the lens is damaged due to the cleaning process, it is not covered by the warranty.



Warning:

- Do not use a spray containing flammable gases to remove dust or dirt from the lens. This may cause a fire due to excessive heat inside the projector.
- Do not clean the lens if the projector is warming up as this may cause the lens' surface film to peel off.
- Do not wipe or tap the lens with a hard object.

Information for your safety and comfort	iii
First things first	viii
Usage Notes	viii
Precautions	viii
Cleaning the lens	ix
Introduction	1
Product Features	1
Package Overview	2
Projector Overview	4
Projector Outlook	4
Control Panel	6
Remote Control Layout	7
Getting Started	10
Connecting the Projector	10
Turning the Projector On/Off	12
Turning on the Projector	12
Turning the projector off	12
Adjusting the Projected Image	14
Adjusting the Height of Projected Image	14
How to get a preferred image size by adjusting distance and zoom	15
User Controls	16
Onscreen Display (OSD) Menus	16
Color	17
Image	19
Setting	22
Management	23
Audio	24
Appendices	25
Troubleshooting	25
LED & Alarm Definition Listing	30
Replacing the Lamp (For service personnel only)	31

Contents

Ceiling Mount Installation	32
Specifications	35
Compatibility modes	38
Regulations and safety notices	43

Introduction

Product Features

This product is a single-chip DLP® projector. Outstanding features include:

- DLP® technology
- Resolution 4K UHD
- Enables projecting 3D content via DLP Link Technology: DLP 3D supported
- High brightness and contrast ratio
- Versatile display mode (Bright, Standard, sRGB, Rec. 709, Movie, Dark Cinema, Game, Football, ISF Day, ISF Night, HDR, HLG, User) enable optimum performance in any situation
- Versatile display modes enable optimum performance in any situation
- NTSC / PAL / SECAM compatible and HDTV (480i/p, 576i/p, 720p, 1080i/p) supported
- Lower power consumption and economy (ECO) mode extend lamp life
- Acer EcoProjecton Technology delivers Intelligent power management approach and physical efficiency improvement
- Equipped with HDMI™ connection supporting HDCP
- Multi-language onscreen display (OSD) menus
- Manual focus/zoom projection lens
- 0.8 ~ 2X digital zoom function
- Microsoft® Windows® 2000, XP, Vista®, Windows 7, Windows 8.1, Windows 10, Macintosh® OS compliant
- Support HDR format
- Support 1080P/120Hz and 1080P/240Hz
- Support 5ms low input lag
- Smart projector: please find more details in Smart source User Manual and CollaVision (WPS) Wireless Projection Support app User Manual.



.....

Note: Functions vary depending on model definition.

Package Overview

This projector comes with all the items shown below. Check to make sure your unit is complete. Contact your dealer immediately if any thing is missing.

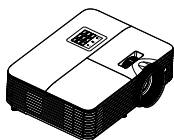

Projector



Power cord

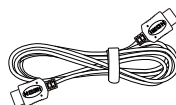

HDMI cable (option)



VGA cable (option)



Quick start guide



Carrying case
(option)

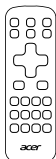

Remote control

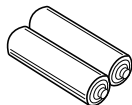

AAA battery x2
(option)

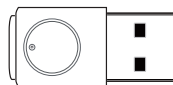

WirelessProjection-Kit
(option)

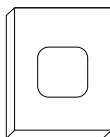

Android TV dongle
(option)

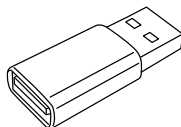

USB fitting
(option)



Note: When projecting a 4K2K/60Hz signal, use an HDMI Premium certified 4K2K/60Hz cable supporting 18Gbps bandwidth.



Trust the cable with the label

Projector Overview

Projector Outlook

Front / upper side

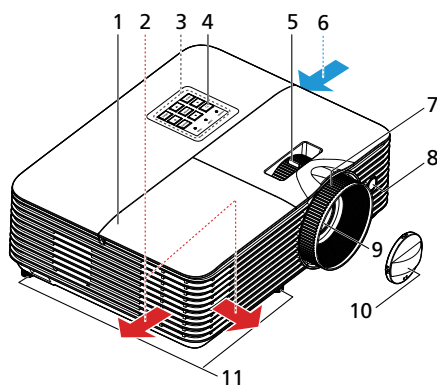

#	Description	#	Description
1	Lamp cover	7	Focus ring
2	Air outlet	8	Remote control receiver
3	Control panel	9	Projection lens
4	Power button	10	Lens cap
5	Zoom ring	11	Tilt adjusting wheels
6	Air inlet		

Rear side

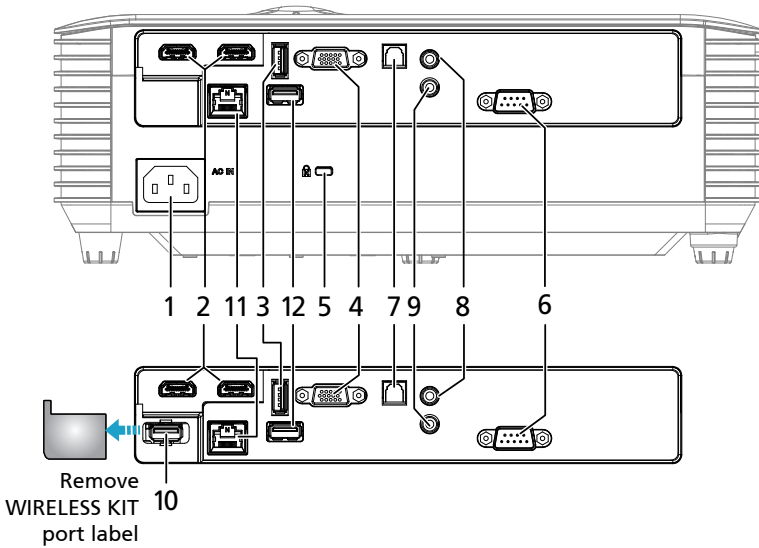

#	Description	#	Description
1	Power socket	7	S/PDIF connector
2	HDMI connector	8	Audio in connector
3	5V DC output connector (firmware upgrade functions)	9	Audio out connector
4	PC analog signal/HDTV/component video input connector	10	USB connector (for wifi dongle)
5	Kensington™ lock port	11	LAN connector
6	RS232 connector	12	USB connector





Note 1: Functions vary depending on model definition.

Note 2: wifi dongle no support hot plug

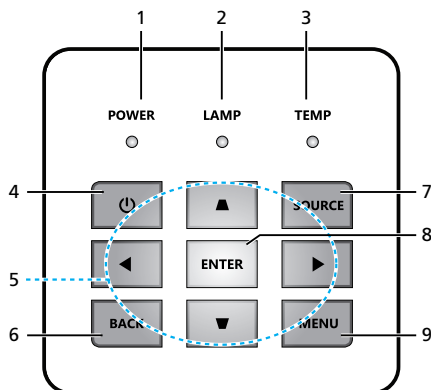
Control Panel



#	Icon	Function	Description
1	POWER	POWER	Power Indicator LED
2	LAMP	LAMP	Lamp Indicator LED
3	TEMP	TEMP	Temp Indicator LED
4		POWER	See the contents in "Turning the Projector On/Off" section.
5		Four directional select keys	<p>▲▼:select OSD items under OSD main menu and adjust image to compensate for distortion under no OSD menu.</p> <p>◀▶:select OSD item under OSD main menu</p>
6	BACK	BACK	Returns to the previous operation.
7	SOURCE	SOURCE	Changes the active source.
8	ENTER	ENTER	Confirm your selection of items.
9	MENU	MENU	Press " MENU " to launch the Onscreen display (OSD) menu or exit the OSD menu.







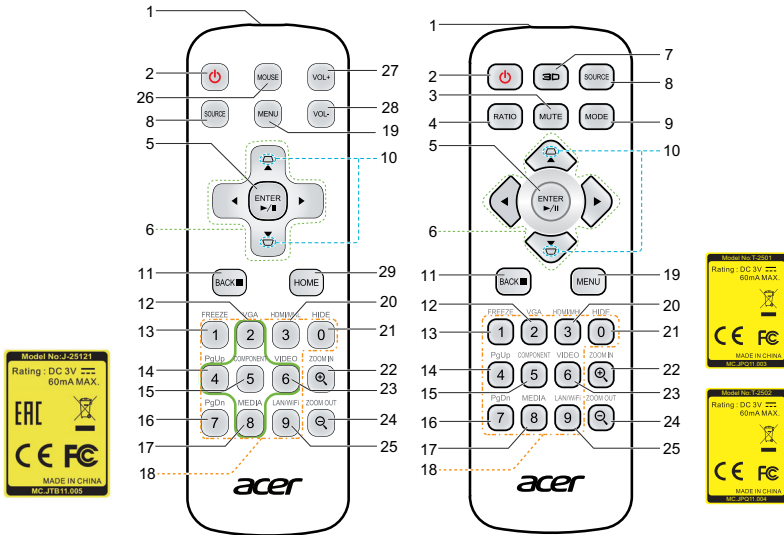













Note : Functions vary depending on model definition.

Remote Control Layout



#	Icon	Function	Description
1		Infrared transmitter	Sends signals to the projector.
2		POWER	Refer to the "Turning the Projector On/Off" section.
3		MUTE	To turn on/off the volume.
4		RATIO	To choose the desired aspect ratio.
5		Select/Enter Play/Pause	Confirm your selection of items. Press to begin/pause playback.
6		Four directional select keys	Use up, down, left, right buttons to select items or make adjustments to your selection.
7		3D	Press "3D" to select 3D models.
8		SOURCE	Changes the active source.
9		MODE	Chooses a display mode.
10		KEystone	Adjusts the image to compensate for distortion caused by tilting the projector.

#	Icon	Function	Description
11		BACK STOP	Returns to the previous operation. Press to stop playback.
12		VGA	Smart : Forbidden function. Others : change source to the VGA connector.
13		FREEZE	No function.
14		PgUp	No function.
15		COMPONENT	Smart: CollaVision (WPS) Wireless Projection Support app hot key. Others: Forbidden function.
16		PgDn	No function.
17		MEDIA	No function.
18		MENU	Smart : Press "MENU" to trigger the Menu Key behavior of the current APP. If the current APP supports Menu Key, it will trigger the Menu Key behavior of the current APP. If it does not support it, it will not action. Others : Press "MENU" to launch the Onscreen display (OSD) menu or exit the OSD menu.
19		HDMI™/MHL	Smart : Forbidden function. Others : Switch to HDMI source.
20		HIDE	Smart : Forbidden function. Other : Momentarily turns off the video. Press "HIDE" to hide the image, press again to display the image.
21		ZOOM IN	Smart : Forbidden function. Other : Zooms the projector display in.
22		VIDEO	No function.
23		ZOOM OUT	Smart : Forbidden function. Other : Zooms the projector display out.
24		LAN/WiFi	No function.
25		Mouse	Smart mode: Switch to mouse mode for Navigation key. Others: Forbidden function.
26		Volume Up	
27		Volume Down	
28		HOME	Smart: Back to home page. Others: Switch to Smart mode.



Note 1: Functions vary depending on model definition.

Note 2: "*"This feature will cause control compatibility issues depending on different level of app support.

Getting Started

Connecting the Projector

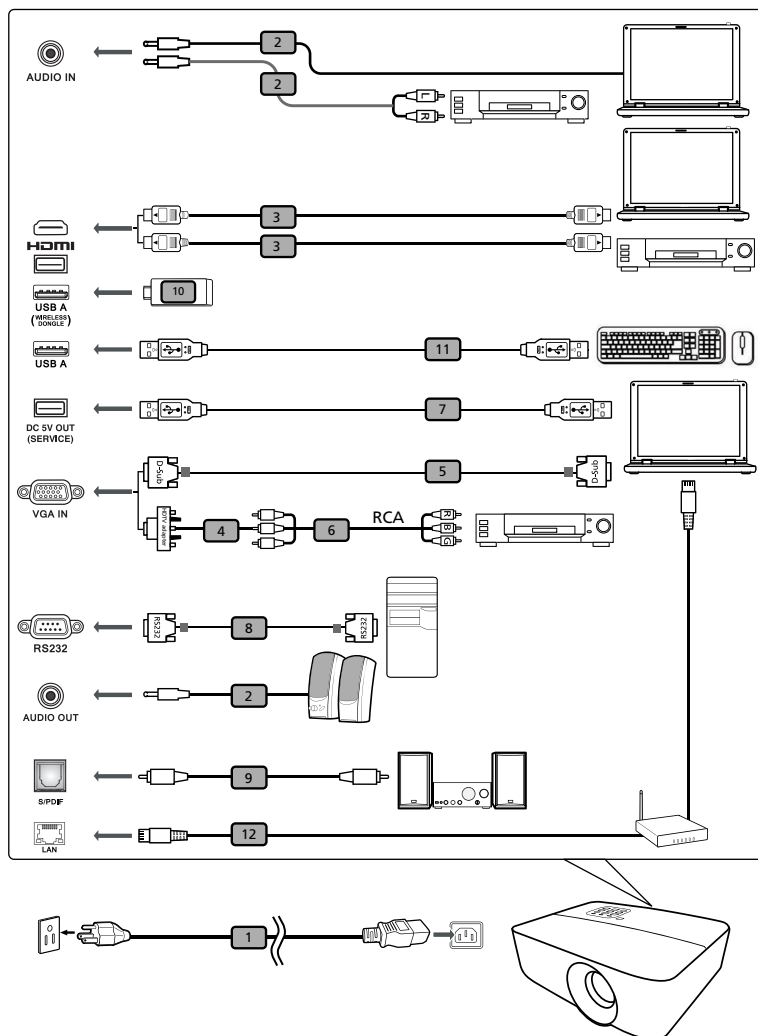

#	Description	#	Description
1	Power cord	7	USB cable
2	Audio cable	8	RS232 cable

#	Description	#	Description
3	HDMI cable	9	S/PDIF cable
4	VGA to component/HDTV adapter	10	USB Dongle
5	VGA cable	11	USB cable
6	3 RCA component cable	12	LAN cable



.....

Note 1: To ensure the projector works well with your computer, please make sure the timing of the display mode is compatible with the projector.

Note 2: Functions vary depending on model definition

Note 3: USB cable needs powered extender if the length is over 5 m.

Note 4: USB DC 5V out connector support 5V power output for power bank charging.

Turning the Projector On/Off

Turning on the Projector

- 1 Ensure that the power cord and signal cable are securely connected. The Power indicator LED will solid red.
- 2 Turn on the projector by pressing "Power" button on the control panel or remote control, and the Power indicator LED will turn blue.
- 3 Turn on your source (computer, notebook, video player ,etc.). The projector will detect your source automatically.
 - If you connect to multiple sources at the same time, use the "Source" button on either control panel or the remote control or direct source key on the remote control to switch between inputs.

Turning the projector off

- 1 To turn the projector off, press and hold the power button. This message appears: **"Power Off? Press power key again."** Press the power button again.
- 2 The LED power indicator will turn RED and blink rapidly after the projector is turned off, and the fan(s) will continue to operate for about 10 minutes to ensure that the system cools properly.
- 3 Once the system has finished cooling, the LED power indicator will stop blinking and turn solid red to indicate standby mode.
- 4 It is now safe to unplug the power cord.



Warning indicators:

- This onscreen message indicates that the projector has overheated. The lamp will automatically turn off, the projector will automatically shut down, and the LED temp indicator will turn solid red. Contact your local dealer or service center.

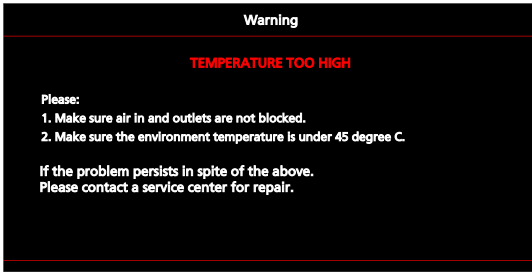

- This onscreen message indicates that the fan has failed. The lamp will automatically turn off, the projector will automatically shut down, and the LED temp indicator will blink. Contact your local dealer or service center.

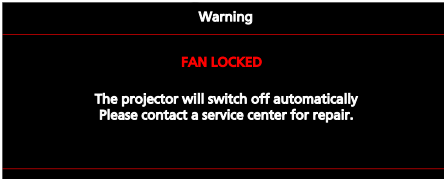

Note 1: Whenever the projector automatically shuts down and the LED lamp indicator turns solid red, contact your local reseller or service center.

Note 2: Functions vary depending on model definition.

Attention! The projector will enter a two minute cool down period to ensure continued optimal lamp operation.

Attention! Please do not turn off projector within 1 minute after power on.

Adjusting the Projected Image

Adjusting the Height of Projected Image

The projector is equipped with elevator feet for adjusting the height of image.

To raise/lower the image:

Use Tilt adjusting wheel to fine-tune the display angle.

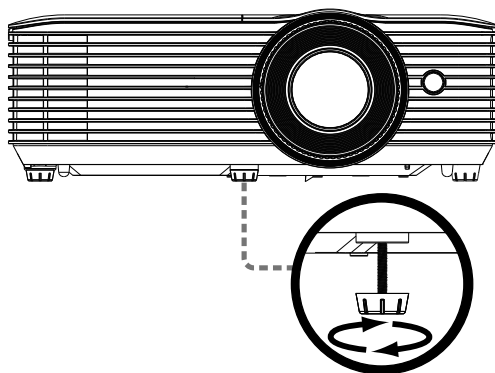

Tilt adjusting wheel

How to get a preferred image size by adjusting distance and zoom

The table below shows how to achieve a desired image size by adjusting either the position or the zoom ring.

- H6800/E8600/HE-4K10/GM820/VH-720/H6800BD+/H6800ABD/H6800BD/H6800a/X6800/X6800a/H6801BDa/H6800BDa/D4K2002/P5827a/M811/N388a/X1827/H6805ATV/H6815P/H6815ATV/H6816ATV/E8615P/HE-4K15P

To obtain an image size of 60" set the projector at a distance 2.0 m and 2.2 m from the screen.

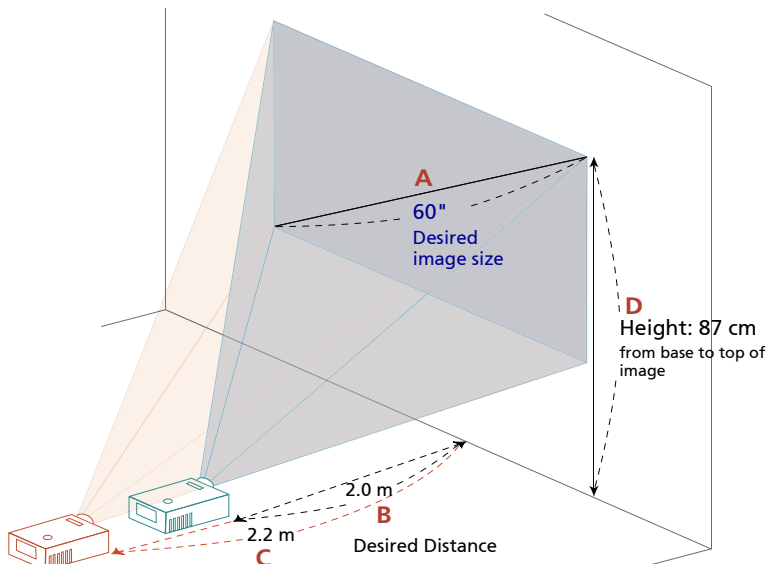

Desired Image Size		Distance (m)		Top (cm)
Diagonal (inch) <A>	W (cm) x H (cm)	Max zoom 	Min zoom <C>	From base to top of image <D>
27	60 x 34		1.0	39
50	111 x 62	1.7	1.8	72
60	133 x 75	2.0	2.2	87
70	155 x 87	2.3	2.6	101
80	177 x 100	2.7	2.9	116
90	199 x 112	3.0	3.3	130
100	221 x 125	3.3	3.7	144
120	266 x 149	4.0	4.4	173
150	332 x 187	5.0	5.5	217
200	443 x 249	6.6	7.3	289
250	553 x 311	8.3	9.2	361
300	664 x 374	9.96		433







Zoom Ratio: 1.1x

User Controls

Onscreen Display (OSD) Menus

The projector has multilingual OSD that allow you to make image adjustments and change a variety of settings.

Using the OSD menus

- To open the OSD menu, press **"MENU"** on the remote control or control panel.
- When the OSD is displayed, use the   keys to select any item in the main menu. After selecting the desired main menu item, press **"ENTER"** to enter submenu for feature setting.
- Use the   keys to select the desired item and adjust the settings by using the   keys.
- Select the next item to be adjusted in the submenu and adjust as described above.
- Press **"BACK"** on the remote control or control panel, the screen will return to the main menu.
- To exit OSD, press **"BACK"** on the remote control or control panel. The OSD menu will close and the projector will automatically save the new settings.

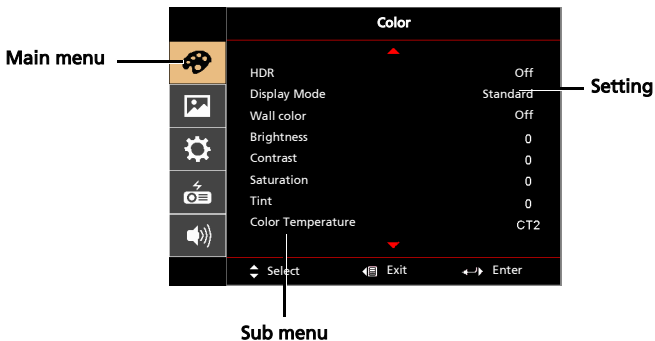

Note 1: Some of the following OSD settings may not be available. Please refer to the actual OSD of your projector.

Note 2: Functions vary depending on model definition.

Color

HDR	<ul style="list-style-type: none"> • Off: disable projection HDR signal automatically. • Auto: enable projection HDR signal automatically.
Display Mode	<p>There are many factory presets optimized for various types of images.</p> <ul style="list-style-type: none"> • Bright: For brightness optimization. • Standard: For common environment. • sRGB: standard RGB color space. • Rec. 709: standard Rec. 709 color space. • Movie: For brighter and general movie/video/photo playing. • Dark Cinema: For dark movie content. • Game: For game content. • Football: For football performance. • ISF Day*: Calibrate and optimize the projection image based on bright environment by an ISF Certified technician. • ISF Night*: Calibrate and optimize the projection image based on dark environment by an ISF Certified technician. • HDR: For HDR content • HLG: For HLG content • User: Memorize user's settings.
Wall color	<p>Use this function to choose a proper color according to the wall. There are several choices, including white, light yellow, light blue, pink, dark green. It will compensate the color deviation due to the wall color to show the correct image tone.</p>
Brightness	<p>Adjust the brightness of the image.</p> <ul style="list-style-type: none"> • Press ◀ to darken the image. • Press ▶ to lighten the image.
Contrast	<p>"Contrast" controls the difference between the lightest and darkest parts of the picture. Adjusting the contrast changes the amount of black and white in the image.</p> <ul style="list-style-type: none"> • Press ◀ to decrease the contrast. • Press ▶ to increase the contrast.
Saturation	<p>Adjusts a video image from black and white to fully saturated color.</p> <ul style="list-style-type: none"> • Press ◀ to decrease the amount of color in the image. • Press ▶ to increase the amount of color in the image.
Tint	<p>Adjusts the color balance of red and green.</p> <ul style="list-style-type: none"> • Press ◀ to increase the amount of green in the image. • Press ▶ to increase the amount of red in the image.

Color Temperature	Mode Use this function to choose CT1, CT2, CT3, User mode.
Gamma	Effects the representation of dark scenery. With greater gamma value, dark scenery looks brighter.
Advanced	Ind. Color Management Adjusts the red, green, blue, cyan, yellow and magenta colors.
	Ind. Hue Adjusts the color balance of red and green.
	Ind. Saturation Adjusts the selected color to be less or more saturated color.
	Ind. Gain Adjusts the selected color's contrast.
	Brilliant Color™ Produces an expanded on-screen color spectrum that delivers enhanced color saturation for bright, true-to-life images.
	Exit Return to previous menu.





















Note 1: "Saturation" and "Tint" functions are not supported under computer or HDMI mode.

Note 2: Functions vary depending on model definition.

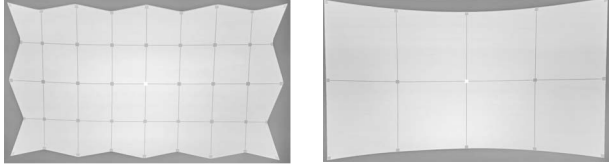
Note 3: "*" Hot key "Power->up->down->up->up" to open ISF mode.

Image

Projection	<ul style="list-style-type: none">  Front: The factory default setting.  Rear: Reverses the image so you can project from behind a translucent screen.
Projection Location	<ul style="list-style-type: none">  Auto: Automatically adjusts projection location of image.  Desktop  Ceiling: Turns the image upside down for ceiling-mounted projection.
Aspect Ratio	<p>Use this function to choose your desired aspect ratio.</p> <ul style="list-style-type: none"> Auto: Keep the image with original width-high ratio and maximize the image to fit native horizontal or vertical pixels. Full: Resize image to fit full screen by width (3840 pixels) and height (2160 pixels). 4:3: The image will be scaled to fit the screen and displayed using a 4:3 ratio. 16:9: The image will be scaled to fit the width of the screen and the height adjusted to display the image using a 16:9 ratio. LBX: Keep original signal aspect ratio and zoom in by 1.333 times.
Sharpness	<p>Adjusts the sharpness of the image.</p> <ul style="list-style-type: none"> Press  to decrease the sharpness. Press  to increase the sharpness.
Keystone	<p>Adjust image distortion caused by tilting projection.</p> 
	<p>Auto Keystone</p> <ul style="list-style-type: none"> Off: Manually adjusts vertical image. On: Automatically adjusts vertical image.
	<p>H. Keystone</p> <p>Press the  or  button to adjust image distortion horizontally and makes a squarer image.</p>
	<p>V. Keystone</p> <p>Press the  or  button to adjust image distortion vertically and makes a squarer image.</p>

	<p>4 Corner Correction Manually adjusts the shape and size of an image that is unevenly rectangular on all sides. Press "MODE" repeatedly to select the corner that you wish to adjust. Press four directional selection keys to adjust the image shape.</p>  <p><Note> The function is unavailable when H./ V. Keystone is adjusted.</p>
	<p>Warping Calibration The function is to configure the geometric distortion of the projector's images when the images are projected onto screens which have a kind of uneven surface such as a cylinder, a spherical shape, etc.</p>  <p style="text-align: center;">Linear Warping Curve Warping</p>
Image Shift	<ul style="list-style-type: none"> Image Shift: Shifts the projected image by pressing .
Signal	<p>H. Position (Horizontal position)</p> <ul style="list-style-type: none"> Press  to move the image left. Press  to move the image right.
	<p>V. Position (Vertical position)</p> <ul style="list-style-type: none"> Press  to move the image down. Press  to move the image up.
	<p>Frequency "Frequency" changes the projector's refresh rate to match the frequency of your computer's graphics card. If you can see a vertical flickering bar in the projected image, use this function to make the necessary adjustments.</p>
	<p>Tracking Synchronizes the signal timing of the projector with the graphics card. If you experience an unstable or flickering image, use this function to correct it.</p>

HDMI	<p>HDMI Color Range Adjust the color range of the HDMI image data to correct color display error.</p> <ul style="list-style-type: none"> • Auto: Automatically adjust by information from player. • Limited Range: Process the input image as limited color range data. • Full Range: Process the input image as full color range data.
	<p>HDMI Scan Info Adjust the overscan ratio of the HDMI image on screen.</p> <ul style="list-style-type: none"> • Auto: Automatically adjust by information from player. • Underscan: Always no overscan on HDMI image. • Overscan: Always keep overscan on HDMI image.
Low Input Lag	<p>Use this function to make the projected screen smoothly without any lag. <Note> When the setting is set to "On", the 3D/Aspect Ratio/Keystone/H. Position/V. Position/HDMI Scan Info/Tracking function will be reset to its factory default settings.</p>
3D	<p>3D Mode Choose "On" to enable DLP 3D function.</p> <ul style="list-style-type: none"> • On: Choose this item while using DLP 3D glasses, 120Hz 3D capable graphics cards and HQFS format file or DVD with corresponding SW player. • Off: Turn off 3D mode. <p>3D Format</p> <ul style="list-style-type: none"> • Auto: When a 3D identification signal is detected, the 3D format is selected automatically. • SBS: Display 3D signal in "Side-by-Side" format. • Top and Bottom: Display 3D signal in "Top and Bottom" format. • Frame Sequential: Display 3D signal in "Frame Sequential" format. <p>3D Sync Invert If you see a discrete or overlapping image while wearing DLP 3D glasses, you may need to execute "On" to get best match of left/right image sequence to get the correct image (for DLP 3D).</p>



Note 1: "H. Position", "V. Position", "Frequency" and "Tracking" functions are not supported under HDMI or Video mode.

Note 2: "HDMI Color Range" and "HDMI Scan Info" functions are only supported under HDMI mode.

Note 3: Functions vary depending on model definition.

Note 4: 3D function is only supported for 120Hz.



Setting

Source Selection	Manual by source menu, Auto by Smart Detection.
HDMI CEC	Default is "Off". Choose "On" to enable HDMI CEC function.
Information	Display the projector information for Model Name, Input Source, Signal Type, Display Mode, Serial No., Software Version and QR code on the screen.
	Scan QR code linking to Acer projector portal via mobile. 
Reset	Reset OSD: Press the "ENTER" button and choose "Yes" to return the parameters on all menus to the factory default settings. Reset SMART: Press the "ENTER" button and choose "Yes" to reset SMART source.



Note: Functions vary depending on model definition.

Management

Lamp Mode	Normal: normal power consumption mode Eco: dim the projector lamp which will lower power consumption Dynamic: automatically optimize the display of dark movie scenes enabling them to be shown in incredible detail.
High Altitude	Choose "On" to turn on High Altitude mode. Operate the fans at full speed continuously to allow for proper high altitude cooling of the projector.
Auto Shutdown (Minutes)	The projector will automatically shutdown when there is no signal input after the allocated time. (default is 15 minutes)
Menu Display Time (Seconds)	Choose the OSD menu display time. (Default is 15 seconds). Select " " to turn off main menu/one direct-key menu manually by user.
Auto Power On	<p>AC Power On Choose "On" to power on projector while AC power plug in.</p> <p>HDMI Power On Choose "On" to power on projector while HDMI power plug in.</p> <p>VGA Power On Choose "On" to power on projector while VGA power plug in.</p> <p>Power Mode (Standby)</p> <ul style="list-style-type: none"> Active: enable support power on the projector via Smart source. Eco: disable support power on the projector via Smart source.
Lamp Information	<p>Lamp Hour Elapse Displays the lamp's elapsed operating time (in hours).</p> <p>Lamp Reminding Activate this function to display a reminder to change the lamp 30 hours before its expected end-of-life.</p> <p>Lamp Hour Reset Choose "Yes" and press "ENTER" to turn the lamp hour counter to 0 hours.</p>
Language	<p>Choose the multilingual OSD menu. Use the   key to select your preferred menu language.</p> <ul style="list-style-type: none"> Press "ENTER" to confirm the selection.



Note: Functions vary depending on model definition.

Audio

Volume	<ul style="list-style-type: none">• Press ◀ to decrease the volume.• Press ▶ to increase the volume.
Internal Speaker	<ul style="list-style-type: none">• Choose "On" to enable internal speaker• Choose "Off" to disable internal speaker
Mute	<ul style="list-style-type: none">• Choose "On" to mute the volume.• Choose "Off" to restore the volume.



Note 1: Functions vary depending on model definition.

Note 2: Volume of SPIDF can not be adjusted.

Appendices

Troubleshooting

If you experience a problem with your Acer projector, refer to the following troubleshooting guide. If the problem persists, please contact your local reseller or service center.

Image Problems and Solutions

#	Problem	Solution
1	No image appears onscreen	<ul style="list-style-type: none"> • Connected as described in the "Getting Started" section. • Ensure none of the connector pins are bent or broken. • Check if the projector lamp has been securely installed. Please refer to the "Replacing the Lamp (For service personnel only)" section. • Make sure you have removed the lens cap and the projector is switched on.
2	Partial, scrolling or incorrectly displayed image (for PC (Windows 2000/XP/Vista/Windows 7/Windows 8))	<ul style="list-style-type: none"> • For an incorrectly displayed image: <ul style="list-style-type: none"> • Open "My Computer", open the "Control Panel", and then double-click the "Display" icon. • Select the "Settings" tab. • Verify that your display resolution setting is lower than or equal to WUXGA-RB (1920 x 1200). • Click the "Advanced Properties" button. • If the problem still appears, change the monitor display you are using and follow the steps below: <ul style="list-style-type: none"> • Verify that the resolution setting is lower than or equal to WUXGA-RB (1920 x 1200). • Click the "Change" button under the "Monitor" tab. • Click "Show all devices". Next, select "Standard monitor types" under the SP box, and choose the resolution mode you need under the "Models" box. • Verify that the resolution setting of the monitor display is lower than or equal to WUXGA-RB (1920 x 1200).

3	Partial, scrolling or incorrectly displayed image (For notebooks)	<ul style="list-style-type: none"> • For an incorrectly displayed image: <ul style="list-style-type: none"> • Follow the steps for item 2 (above) to adjust the resolution of your computer. • Press the toggle output settings. Example: [Fn]+[F4], Compaq [Fn]+[F4], Dell [Fn]+[F8], Gateway [Fn]+[F4], IBM [Fn]+[F7], HP [Fn]+[F4], NEC [Fn]+[F3], Toshiba [Fn]+[F5] • If you experience difficulty changing resolutions or your monitor freezes, restart all equipment including the projector.
4	The screen of the notebook computer is not displaying your presentation	<ul style="list-style-type: none"> • If you are using a Microsoft® Windows® based notebook: Some notebook PCs may deactivate their own screens when a second display device is in use. Each has a different way to be reactivated. Refer to your computer's manual for detailed information. • If you are using an Apple® Mac® OS based notebook: In System Preferences, open Display and select Video Mirroring "On".
5	Image is unstable or flickering	<ul style="list-style-type: none"> • Adjust the "Tracking" to correct it. Refer to the "Image" section for more information. • Change the display color depth settings on your computer.
6	Image has vertical flickering bar	<ul style="list-style-type: none"> • Use "Frequency" to make an adjustment. Refer to the "Image" section for more information. • Check and reconfigure the display mode of your graphics card to make it compatible with the projector.
7	Image is out of focus	<ul style="list-style-type: none"> • Make sure the lens cap is removed. • Adjusts the focus ring on the projector lens. • Make sure the projection screen is within the required distance from the projector. Refer to the "How to get a preferred image size by adjusting distance and zoom" section for more information.
8	Image is stretched when displaying a "widescreen" DVD title	<p>When you play a DVD encoded in anamorphic or 16:9 aspect ratio you may need to adjust the following settings:</p> <ul style="list-style-type: none"> • If you play a 4:3 format DVD title, please change the format to 4:3 in the projector OSD. • If the image is still stretched, you will also need to adjust the aspect ratio. Set up the display format to 16:9 (wide) aspect ratio on your DVD player. • If you play an Letterbox (LBX) format DVD title, please change the format to Letterbox (LBX) in the projector OSD.

9	Image is too small or too large	<ul style="list-style-type: none"> • Adjust the zoom ring on the projector. • Move the projector closer to or further from the screen. • Press "MENU" on the remote control. Go to "Image -> Aspect Ratio" and try different settings or press "RATIO" on the remote control to adjust directly.
10	Image has slanted sides	<ul style="list-style-type: none"> • If possible, reposition the projector so that it is centered on the screen. • Press the "Keystone Δ / ∇" button on the remote control until the sides are vertical.
11	Image is reversed	<ul style="list-style-type: none"> • Select "Image --> Projection Mode" on the OSD and adjust the projection direction.
12	LAN/WiFi, USB Display source show No signal	<ul style="list-style-type: none"> • Power off projector and power on again.
13	Image hangs up when displaying photo or document in Media	<ul style="list-style-type: none"> • Power off projector and power on again.

OSD Messages

#	Condition	Message Reminder
1	Message	<ul style="list-style-type: none"> <li data-bbox="394 280 760 304">• Fan Fail - the system fan is not working. <div data-bbox="441 304 885 483" style="background-color: black; color: white; padding: 10px; border: 1px solid red;"> <p style="text-align: center; margin: 0;">Warning</p> <hr style="border: 1px solid red;"/> <p style="text-align: center; color: red; margin: 5px 0;">FAN LOCKED</p> <p style="text-align: center; margin: 0;">The projector will switch off automatically Please contact a service center for repair.</p> </div> <ul style="list-style-type: none"> <li data-bbox="394 512 932 596">• Projector Overheated - the projector has exceeded its recommended operating temperature and must be allowed to cool down before it may be used. Please check the following message. <div data-bbox="399 596 932 826" style="background-color: black; color: white; padding: 10px; border: 1px solid red;"> <p style="text-align: center; margin: 0;">Warning</p> <hr style="border: 1px solid red;"/> <p style="text-align: center; color: red; margin: 5px 0;">TEMPERATURE TOO HIGH</p> <p style="margin: 0;">Please:</p> <ol style="list-style-type: none"> 1. Make sure air in and outlets are not blocked. 2. Make sure the environment temperature is under 45 degree C. <p style="margin: 0;">If the problem persists in spite of the above. Please contact a service center for repair.</p> </div> <p data-bbox="394 826 901 868">Please also check the dust filters if they are installed. If the dust filter is clogged with dust, please clean it.</p> <ul style="list-style-type: none"> <li data-bbox="394 896 929 938">• Replace the lamp - the lamp is about to reach its maximum lifetime. Prepare to replace it soon. <div data-bbox="444 943 888 1121" style="background-color: black; color: white; padding: 10px; border: 1px solid red;"> <p style="text-align: center; margin: 0;">Warning</p> <hr style="border: 1px solid red;"/> <p style="text-align: center; color: red; margin: 5px 0;">Lamp Warning</p> <p style="text-align: center; margin: 0;">Lamp life exceeded.</p> </div>

Problems with the Projector

#	Condition	Solution
1	The projector stops responding to all controls	<ul style="list-style-type: none"> • If possible, turn off the projector, then unplug the power cord and wait at least 30 seconds before reconnecting power.
2	Lamp burns out or makes a popping sound	<ul style="list-style-type: none"> • When the lamp reaches the end of its useful life, it will burn out and may make a loud popping sound. If this happens, the projector will not turn on until the lamp module has been replaced. To replace the lamp, follow the procedures in the "Replacing the Lamp (For service personnel only)" section.
3	Wifi or Bluetooth cannot be detected normally.	<ul style="list-style-type: none"> • Plug in wifi dongle again and restart projector.

LED & Alarm Definition Listing

LED Messages

Message	Lamp_LED	Temp_LED	Power LED	
	Red	Red	Red	Blue
Standby	--	--	ON	--
Power button ON	--	--	--	ON
Lamp retry	--	--	--	Quick Flashing
Power off (Cooling state)	--	--	Quick Flashing	--
Power button OFF (cooling completed; standby mode)	--	--	ON	--
Error (thermal failure)	--	ON	--	ON
Error (fan lock)	--	Quick Flashing	--	ON
Error (lamp breakdown)	ON	--	--	ON
Error (color wheel fail)	Quick Flashing	--	--	ON

Replacing the Lamp (For service personnel only)

The projector will detect the lamp life. You will be shown a warning message "**Lamp Warning! Lamp life exceeded.**" When you see this message, change the lamp as soon as possible. Make sure the projector has been cooling down for at least 45 minutes before changing the lamp.



.....
Warning: The lamp compartment is hot! Allow it to cool down before changing the lamp.

Warning: To reduce the risk of personal injury, do not drop the lamp module or touch the lamp bulb. The bulb may shatter and cause injury if it is dropped.

Warning: Do not attempt to replace the lamp yourself. Contact the qualified service personnel for replacement.

Ceiling Mount Installation

If you wish to install the projector using a ceiling mount, please refer to the steps below:

- 1 Drill four holes into a solid, structural ceiling member, and secure the ceiling mount base to the ceiling.

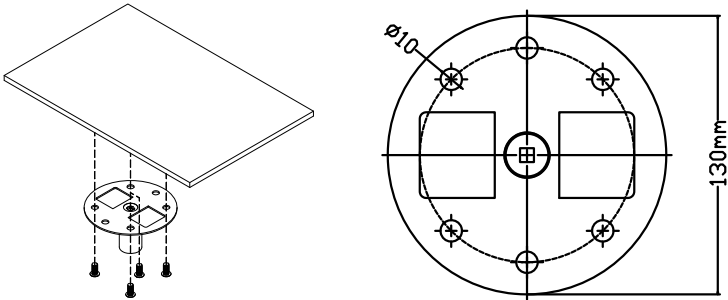

- 2 Choose the length combination based on actual environment. (CM-01S doesn't include Type 2 and Type 3.)

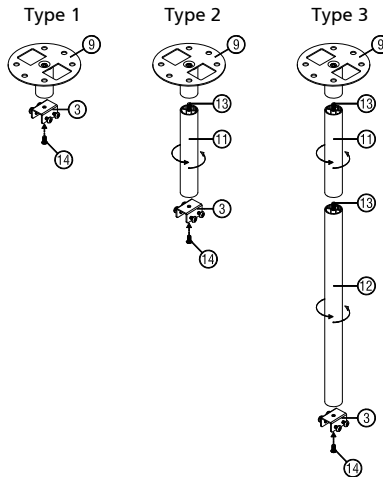

3 Type 1:

For the standard size use three bracket screws to mount the projector to the ceiling mount bracket.

Type 2 and Type 3:

Alternatively, for the larger size, use the sliding extensions for more supports.

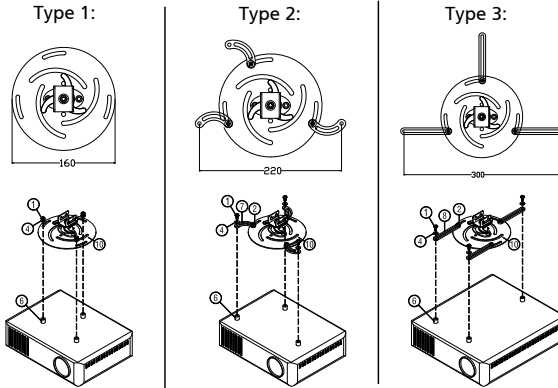

Note: It is recommended that you keep a reasonable space between the bracket and the projector to allow for proper heat distribution.

- 4 Connect the main body connector to the projector bracket (illustration 1), and then screw up four screws (illustration 2).

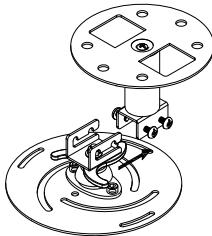

Illustration 1

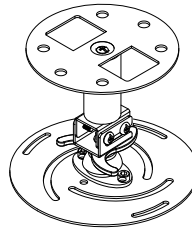
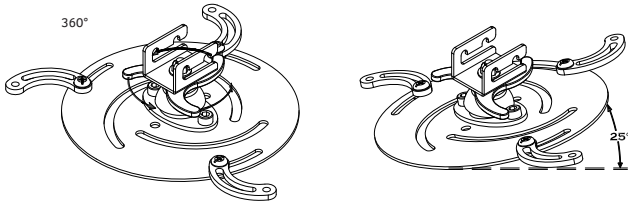
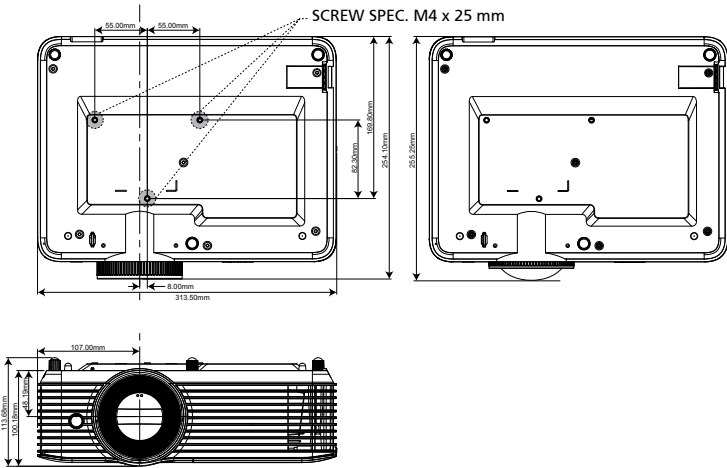

Illustration 2

5 Adjust the angle and positioning as necessary.



Screw Type B		Washer Type	
Diameter (mm)	Length (mm)	Large	Small
4	25	V	V



Specifications

The specifications listed below are subject to change without notice. For final specs, please refer to Acer's published marketing specifications.

Projection system	DLP®
Computer compatibility	IBM PC and compatibles, Apple Macintosh, iMac and VESA standards: SXGA, XGA, VGA, SVGA, SXGA+, WXGA, WXGA+, WSXGA +
Video compatibility	NTSC (3.58/4.43), PAL (B/D/G/H/I/M/N), SECAM (B/D/G/K/K1/L), HDTV (720p, 1080i, 1080p), EDTV (480p, 576p), SDTV (480i, 576i)
Displayable colors	1.07 billion colors
Horizontal scan rate	31 - 140 kHz
Vertical refresh scan rate	24 - 240 Hz
Digital zoom	0.8x ~ 2.0x
Power supply	AC input 100 - 240 V auto-switching power supply
Operating temperature	0°C to 40°C / 32°F to 104°F
Standard package contents	<ul style="list-style-type: none"> • AC power cord x1 • HDMI cable x1 (option) • VGA cable x1 (option) • Remote control x1 • AAA battery x2 (for remote control) (option) • Quick start guide (Projector) x1 • Carrying case x1 (option) • Android TV dongle x1 (option) • USB fitting x1 (option) • WirelessProjection-Kit x1 (option)



Note 1: Design and specifications are subject to change without notice.

Note 2: * Functions vary depending on model definition.

H6800/E8600/HE-4K10/GM820/VH-720/H6800BD+/H6800ABD/H6800BD/
H6800a/X6800/X6800a/H6801BDa/H6800BDa/D4K2002/H6805BDa/E8605/
X6810/H6805BD/H6807BDa/H6815BDa/H6816ABD/P5827a/M811/N388a/X1827/
H6805ATV/H6815P/H6815ATV/H6816ATV/E8615P/HE-4K15P

Resolution	4K UHD resolution <ul style="list-style-type: none"> Maximum: UXGA (1600 x 1200), WSXGA+ (1680x1050), 1080p(1920x1080), WUXGA-RB (1920 x 1200), UHD(3840x2160),4K(4120x2160)
Aspect ratio	Auto, Full, 4:3, 16:9, LBX
Optical zoom ratio	1.1X
Throw ratio	1.50 ~ 1.66 (60"@2m)
Projection lens	F = 1.98 ~ 2.02, f = 15.84mm ~ 17.44mm, Manual Zoom & Focus
Projection screen size (diagonal)	27" ~ 301" (69cm ~ 765cm)
Projection distance	1.0m ~ 10m (3.3' ~ 32.7')
Lamp type	240W lamp
Audio	Internal speaker with 10W x 1 output
Weight	3.1 Kg (6.83 lbs)
Dimensions (W x D x H) (with feet)	313mm x 240mm x 113.7mm (12.3" x 9.4" x 4.5")
Power consumption	Normal mode:310W±10%@ 110VAC ECO mode:215W±10%@ 110VAC Standby mode< 0.5W

I/O connectors	H6800BDa/E8605/X6810/ H6815BDa/H6816ABD/ H6800/E8600/HE-4K10/ X6800/VH-720/ H6800BD+/H6800ABD/ H6800BD/H6800BD/ X6800a/H6801BDa/ H6800BDa	H6805BD/X1827/ H6805ATV / H6815P/ H6815ATV/ H6816ATV/ E8615P /HE- 4K15P	P5827a/M811/ H6805BDa/ N388a
Power socket	V	V	V
VGA IN	V	V	V
HDMI 1	V	V	V
HDMI 2	V	V	V
RS232	V	V	V
3.5 mm audio jack input	V	V	V
3.5 mm audio jack output	V	V	V
5V DC output	V	V	V
S/PDIF	V	V	V
USB A1 (Wireless dongle)	V		V
USB A2			V
LAN port			V



Note 1: Design and specifications are subject to change without notice.

Note 2: * Functions vary depending on model definition.

Compatibility modes

A. VGA Analog

1 VGA Analog - PC Signal

Modes	Resolution	V.Frequency [Hz]	H.Frequency [KHz]
VGA	640x480	60	31.5
	640x480	72	37.9
	640x480	75	37.5
	640x480	85	43.3
	640x480	120	61.9
SVGA	800x600	56	35.1
	800x600	60	37.9
	800x600	72	48.1
	800x600	75	46.9
	800x600	85	53.7
XGA	800x600	120	77.4
	1024x768	60	48.4
	1024x768	70	56.5
	1024x768	75	60.0
	1024x768	85	68.7
SXGA	1024x768	120	99.0
	1152x864	70	63.8
	1152x864	75	67.5
	1152x864	85	77.1
	1280x1024	60	64.0
QuadVGA	1280x1024	72	77.0
	1280x1024	75	80.0
	1280x1024	85	91.1
	1280x960	60	60.0
	1280x960	75	75.2
SXGA+	1400x1050	60	65.3
UXGA	1600x1200	60	75.0
PowerBook G4	640x480	60	31.4
PowerBook G4	640x480	66.6(67)	34.9
PowerBook G4	800x600	60	37.9
PowerBook G4	1024x768	60	48.4
PowerBook G4	1152x870	75	68.7
PowerBook G4	1280x960	75	75.0
i Mac DV (G3)	1024x768	75	60.0

2 VGA Analog - Extended Wide timing

Modes	Resolution	V.Frequency [Hz]	H.Frequency [KHz]
WXGA	1280x768	60	47.8
	1280x768	75	60.3
	1280x768	85	68.6
	1280x720	60	44.8
	1280x720	120	92.9
	1280x800	60	49.6
	1280x800	119.909	101.6
	1920x1200	60	74
WSXGA+	1440x900	60	59.9
	1680x1050	60	65.3
	1920x1080 (1080P)	60	67.5
WUXGA	1366x768	60	47.7
	1920x1200-RB	59.94	74.04

3 VGA Analog -Component Signal

Modes	Resolution	V.Frequency [Hz]	H.Frequency [KHz]
480i	720x480(1440x480)	59.94 (29.97)	15.7
576i	720x576(1440x576)	50(25)	15.6
480p	720x480	59.94	31.5
576p	720x576	50	31.3
720p	1280x720	60	45.0
720p	1280x720	50	37.5
1080i	1920x1080	60(30)	33.8
1080i	1920x1080	50(25)	28.1
1080p	1920x1080	23.97/24	27.0
1080p	1920x1080	60	67.5
1080p	1920x1080	50	56.3

B. HDMI Digital

1 HDMI - PC Signal

Modes	Resolution	V.Frequency [Hz]	H.Frequency [KHz]
VGA	640x480	60	31.5
	640x480	72	37.9
	640x480	75	37.5
	640x480	85	43.3
	640x480	120	61.9
SVGA	800x600	56	35.1

	800x600	60	37.9
	800x600	72	48.1
	800x600	75	46.9
	800x600	85	53.7
	800x600	120	77.4
XGA	1024x768	60	48.4
	1024x768	70	56.5
	1024x768	75	60.0
	1024x768	85	68.7
	1024x768	120	99.0
SXGA	1152x864	70	63.8
	1152x864	75	67.5
	1152x864	85	77.1
	1280x1024	60	64.0
	1280x1024	72	77.0
	1280x1024	75	80.0
	1280x1024	85	91.1
QuadVGA	1280x960	60	60.0
	1280x960	75	75.2
SXGA+	1400x1050	60	65.3
UXGA	1600x1200	60	75.0
1080p	1920x1080	240	270
PowerBook G4	640x480	60	31.4
PowerBook G4	640x480	66.6(67)	34.9
PowerBook G4	800x600	60	37.9
PowerBook G4	1024x768	60	48.4
PowerBook G4	1152x870	75	68.7
PowerBook G4	1280x960	75	75.0
i Mac DV (G3)	1024x768	75	60.0

2 HDMI - Extended Wide timing

Modes	Resolution	V.Frequency [Hz]	H.Frequency [KHz]
WXGA	1280x768	60	47.8
	1280x768	75	60.3
	1280x768	85	68.6
	1280x720	60	44.8
	1280x720	120	92.9
	1280x800	60	49.6
	1280x800-RB	119.909	101.6
	1440x900	60	59.9
	1920x1200	60	74

WSXGA+	1680x1050	60	65.3
	1920x1080 (1080P)	60	67.5
	1920x1080 (1080P)	50	56.3
	1366x768	60	47.7
WUXGA	1920x1200-RB	59.94	74.04
4K	3840x1600	60	99.48
	3840x1080	60	66.898

3 HDMI - Video Signal

Modes	Resolution	V.Frequency [Hz]	H.Frequency [KHz]
480i	720x480(1440x480)	59.94 (29.97)	15.7
576i	720x576(1440x576)	50(25)	15.6
480p	720x480	59.94	31.5
576p	720x576	50	31.3
720p	1280x720	60	45.0
720p	1280x720	50	37.5
1080i	1920x1080	60(30)	33.8
1080i	1920x1080	50(25)	28.1
1080p	1920x1080	23.97/24	27.0
1080p	1920x1080	25	28.1
1080p	1920x1080	29.97/30	33.8
1080p	1920x1080	60	67.5
1080p	1920x1080	50	56.3
1080p	1920x1080	120	135
1080p	1920x1200-RB	59.94	74.04
4K	3840x2160	60	135
	3840x2160	24	54
	3840x2160	25	56.25
	3840x2160	30	67.5
	3840x2160	50	112.5

4 HDMI - 1.4a 3D Timing

Modes	Resolution	V.Frequency [Hz]	H.Frequency [KHz]
720p (Frame Packing)	1280 x 720	50	37.5
720p (Frame Packing)	1280 x 720	60	45.0
1080p (Frame Packing)	1920 x 1080	24	27.0
720p (Frame Packing)	1280 x 720	50	37.5

720p (Frame Packing)	1280 x 720	60	45.0
1080i (Top and Bottom)	1920 x1080	50 (25)	28.1
1080i (Top and Bottom)	1920 x1080	60 (30)	33.8
1080p (Top and Bottom)	1920 x1080	24	27.0
1080p (Top and Bottom)	1920 x1080	50	56.3
1080p (Top and Bottom)	1920 x1080	60	67.5
720p (Side by Side (Half))	1280 x 720	60	45.0
1080i (Side by Side (Half))	1920 x1080	50 (25)	28.1
1080i (Side by Side (Half))	1920 x1080	60 (30)	33.8
1080p (Side by Side (Half))	1920 x1080	50	56.3
1080p (Side by Side (Half))	1920 x1080	60	67.5
Graphic source monitor range limits	Horizontal scan rate:		15k-100kHz
	Vertical scan rate:		24-120 Hz
	Max. pixel rate:		Analog:165MHz Digital:165MHz



.....

Note 1: Functions vary depending on model definition.

Note 2: MHL 1080p 3D 24p frame packing is not supported.

Regulations and safety notices

FCC notice

This device has been tested and found to comply with the limits for a Class B digital device pursuant to Part 15 of the FCC rules. These limits are designed to provide reasonable protection against harmful interference in a residential installation. This device generates, uses, and can radiate radio frequency energy and, if not installed and used in accordance with the instructions, may cause harmful interference to radio communications.

However, there is no guarantee that interference will not occur in a particular installation. If this device does cause harmful interference to radio or television reception, which can be determined by turning the device off and on, the user is encouraged to try to correct the interference by one or more of the following measures:

- Reorient or relocate the receiving antenna.
- Increase the separation between the device and receiver.
- Connect the device into an outlet on a circuit different from that to which the receiver is connected.
- Consult the dealer or an experienced radio/television technician for help.

Notice: Shielded cables

All connections to other computing devices must be made using shielded cables to maintain compliance with FCC regulations.

Notice: Peripheral devices

Only peripherals (input/output devices, terminals, printers, etc.) certified to comply with the Class B limits may be attached to this equipment. Operation with non-certified peripherals is likely to result in interference to radio and TV reception.

Caution

Changes or modifications not expressly approved by the manufacturer could void the user's authority, which is granted by the Federal Communications Commission, to operate this device.

Operation conditions

This device complies with Part 15 of the FCC Rules. Operation is subject to the following two conditions: (1) this device may not cause harmful interference, and (2) this device must accept any interference received, including interference that may cause undesired operation.

Notice: Canadian users

This Class B digital apparatus complies with Canadian ICES-003.

Remarque à l'intention des utilisateurs canadiens

Cet appareil numérique de la classe B est conforme à la norme NMB-003 du Canada.

Compliant with Russian/ Ukraine regulatory certification



Radio device regulatory notice



Note: The regulatory information below is for models with wireless LAN and/or Bluetooth only.

General

This product complies with the radio frequency and safety standards of any country or region in which it has been approved for wireless use. Depending on configurations, this product may or may not contain wireless radio devices (such as wireless LAN and/or Bluetooth modules).

Canada — Low-power license-exempt radio communication devices (RSS-247)

- a Common information
Operation is subject to the following two conditions:
 1. This device may not cause interference, and
 2. This device must accept any interference, including interference that may cause undesired operation of the device.
- b Operation in 2.4 GHz band
To prevent radio interference to the licensed service, this device is intended to be operated indoors and installation outdoors is subject to licensing.

List of applicable countries

This device must be used in strict accordance with the regulations and constraints in the country of use. For further information, please contact the local office in the country of use. Please see <http://ec.europa.eu/enterprise/rtte/implem.htm> for the latest country list.

Recycling Information for the United States of America

Acer encourages information technology (IT) equipment owners to responsibly recycle their equipment when it is no longer needed. Acer offers programs and services to assist equipment owners with this process.

For more information on recycling IT equipment, please go to:
<https://www.acer.com/ac/en/US/content/recycling>