



USER MANUAL

MODEL:

MV-4X

4 Window Multi-viewer/4x2 Seamless Matrix Switcher



Contents

Introduction	1
Getting Started	1
Overview	2
Typical Applications	3
Controlling your MV-4X	4
Defining MV-4X 4 Window Multi-viewer/4x2 Seamless Matrix Switcher	5
Mounting MV-4X	7
Connecting MV-4X	8
Connecting the Output to a Balanced/Unbalanced Stereo Audio Acceptor	9
Connecting to MV-4X via RS-232	9
Wiring RJ-45 Connectors	9
Operating and Controlling MV-4X	10
Using Front Panel Buttons	10
Controlling and Operating Via the OSD Menu	10
Operating via Ethernet	21
Using Embedded Web Pages	25
General Operation Settings	27
Defining the Matrix Mode Parameters	31
Defining the Multi-View Parameters	34
Defining the Auto-Layout Parameters	40
Managing EDID	41
Defining General Settings	44
Defining Interface Settings	46
Defining MV-4X User Access	47
Defining Advanced Settings	48
Defining OSD Settings	51
Configuring a Logo	52
Viewing the About Page	54
Technical Specifications	55
Default Communication Parameters	56
Default EDID	56
Protocol 3000	59
Understanding Protocol 3000	59
Protocol 3000 Commands	60
Result and Error Codes	71

Introduction

Welcome to Kramer Electronics! Since 1981, Kramer Electronics has been providing a world of unique, creative, and affordable solutions to the vast range of problems that confront the video, audio, presentation, and broadcasting professional on a daily basis. In recent years, we have redesigned and upgraded most of our line, making the best even better!

Getting Started

We recommend that you:

- Unpack the equipment carefully and save the original box and packaging materials for possible future shipment.
- Review the contents of this user manual.



Go to www.kramerav.com/downloads/MV-4X to check for up-to-date user manuals, application programs, and to check if firmware upgrades are available (where appropriate).

Achieving Best Performance

- Use only good quality connection cables (we recommend Kramer high-performance, high-resolution cables) to avoid interference, deterioration in signal quality due to poor matching, and elevated noise levels (often associated with low quality cables).
- Do not secure the cables in tight bundles or roll the slack into tight coils.
- Avoid interference from neighboring electrical appliances that may adversely influence signal quality.
- Position your Kramer **MV-4X** away from moisture, excessive sunlight and dust.

Safety Instructions



Caution:

- This equipment is to be used only inside a building. It may only be connected to other equipment that is installed inside a building.
- For products with relay terminals and GPIO ports, please refer to the permitted rating for an external connection, located next to the terminal or in the User Manual.
- There are no operator serviceable parts inside the unit.



Warning:

- Use only the power cord that is supplied with the unit.
- To ensure continuous risk protection, replace fuses only according to the rating specified on the product label which is located on the bottom of the unit.

Recycling Kramer Products

The Waste Electrical and Electronic Equipment (WEEE) Directive 2002/96/EC aims to reduce the amount of WEEE sent for disposal to landfill or incineration by requiring it to be collected and recycled. To comply with the WEEE Directive, Kramer Electronics has made arrangements with the European Advanced Recycling Network (EARN) and will cover any costs of treatment, recycling and recovery of waste Kramer Electronics branded equipment on arrival at the EARN facility. For details of Kramer's recycling arrangements in your particular country go to our recycling pages at www.kramerav.com/il/quality/environment.

Overview

Congratulations on purchasing your Kramer **MV-4X** 4 Window Multi-viewer/4x2 Seamless Matrix Switcher.

MV-4X is a high-performance HDMI matrix switcher with integrated scaling technology and multi-windowing options. It is an ideal solution for monitoring or displaying multiple sources simultaneously for use in control rooms, conference rooms or classrooms. Video resolutions up to 4K@60Hz 4:4:4 and LPCM audio up to 7.1 channels and 192kHz are supported on both input and output. In addition, **MV-4X** is fully compatible with the HDCP 1.x and 2.3 standards.

The product offers 2 outputs – HDMI and HDBT. Users can choose to display any of the four HDMI sources individually, in full screen, or in a variety of multi-window modes that include quad mode, PiP, and PoP on both outputs. Alternatively, **MV-4X** offers a seamless (zero-time video cut) 4x2 matrix switcher option. The product also supports chroma-keying and includes a logo overlay feature.

You can control and manage the **MV-4X**, including the input/window routing, position, and size via the front panel OSD buttons, Ethernet (with embedded webpages), and RS-232.

MV-4X provides exceptional quality, advanced and user-friendly operation, and flexible control.

Exceptional Quality

- High Performance Multi-Viewer – 18G 4K HDMI product with 4 HDMI inputs and HDBT and HDMI outputs that supports HDMI up to 4K@50/60Hz 4:4:4 and HDBT up to 4K@50/60Hz 4:2:0.
- Zero-Time Video Cuts – Connect up to four HDMI sources, an HDMI and an HDBT sink, and seamlessly switch between them.
- HDMI Support – HDR10, CEC (for outputs only), 4K@60Hz, Y420, BT.2020, Deep Color (for inputs only), x.v.Color™, 7.1 PCM, Dolby TrueHD, DTS-HD, as specified in HDMI 2.0.
- Content Protection – Supports HDCP 2.3.
- Chroma Keying Support – Select to key the video input using a uniform-colored background.
- Includes numerous filters and algorithms that eliminate picture artifacts.

Advanced and User-friendly Operation

- Matrix Switching – Truly seamless zero-time 4x2 switching in Matrix mode.
- Multiple Display Options – Display any of 4 HDMI sources individually, full screen, with seamless switching in Matrix mode. Or choose to display the sources using multi-window modes such as fully customizable standard views like PiP (Picture in Picture) and PoP (Picture outside of Picture) as well as Quad-window modes.
- 4 Preset Memory Locations – Supports storage of multi-window arrangements as a preset for later use.
- Auto Layout Support – Auto-window mode that automatically changes the number of visible windows based on the number of live sources.
- Independent audio source selection in all modes.
- Image Rotation – 90, 180 and 270-degree rotation support for 4K output resolutions on input 1 in matrix mode.
- Selectable Border Design – Each window can have a border with a selectable color.
- Logo Support – Upload and freely position a graphic logo overlay as well as a boot screen logo.
- Multi-view window Setup – Intuitive and easy adjustment of window size, position, and settings.
- User-friendly Control – Via the built-in Web GUI, as well via the OSD-driven front-panel switches.
- EDID Management – Per-input EDID management with internal or external EDID options.
- Local Monitor View – Matrix mode is ideal for applications where the user requires a local monitor to view the image on the display before switching it to the remote display.

Flexible Connectivity

- 4 HDMI inputs.
- 1 HDMI output and 1 HDBT output.
- De-embedded analog balanced stereo audio output.

Typical Applications

MV-4X is ideal for these typical applications:

- Meeting rooms - Allows users to show multiple presentations simultaneously.
- Distance learning classrooms – Enables to show the main picture content, while the teacher shows in the Picture-in-picture (PiP) window.
- Medical – Quad view for operating theatres.
- Shopping malls and residential – Shows multiple images at the same time.
- Video editing, post production and applications that require chroma keying.

Controlling your MV-4X

Control your **MV-4X** directly via the front panel push buttons, with on-screen menus, or:

- By RS-232 serial commands transmitted by a touch screen system, PC, or other serial controller.
- Remotely through the Ethernet using built-in user-friendly Web pages.
- Direct connections for HDBT tunneling of IR and RS-232.
- Optional - USB port to upgrade the firmware, upload the EDID, and Logo.

Defining MV-4X 4 Window Multi-viewer/4x2 Seamless Matrix Switcher

This section defines MV-4X.

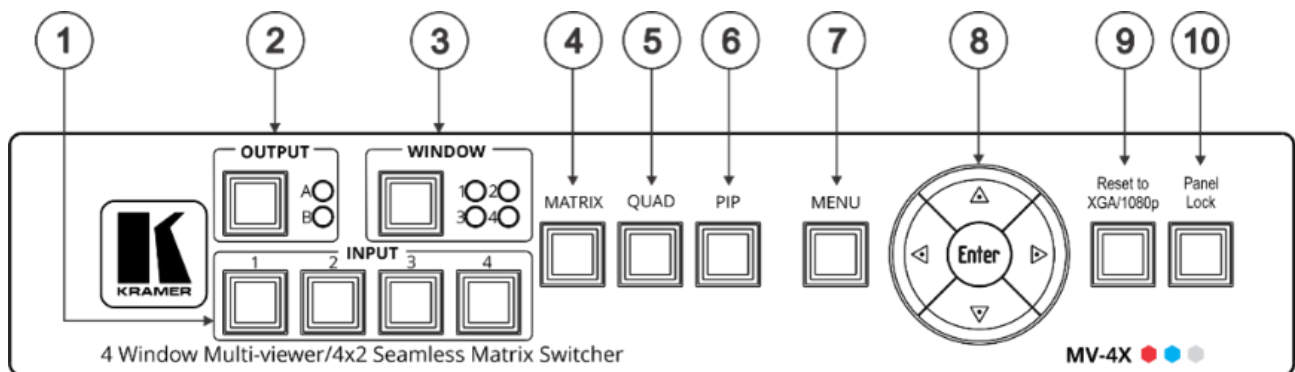

Figure 1: MV-4X 4 Window Multi-viewer/4x2 Seamless Matrix Switcher Front Panel

#	Feature	Function	
1	INPUT Selector Buttons (1 to 4)	Press to select an HDMI input (from 1 to 4) to switch to an output.	
2	OUTPUT (in Matrix Mode)	Selector Button	Press to select an output.
		LEDs (A and B)	Light green when output A (HDMI) or B (HDBT) are selected.
3	WINDOW (in Multiview Mode)	Selector Button	Press followed by an input button to connect the selected input to a window. For example, select Window 3 and then Input button # 2 to connect input # 2 to Window 3.
		LEDs (1 to 4)	Light green when a window is selected.
4	MATRIX Button	Press to operate the system as a 4x2 matrix switcher.	
5	QUAD Button	Press to display all four inputs on each of the outputs. Layouts are configured via the embedded web pages.	
6	PIP Button	Press to display one input in the background and the other images as PiP (Picture-in-Picture) over that image. Layouts are configured via the embedded web pages.	
7	MENU Button	Press to access the OSD menu, exit the OSD menu and, when in the OSD menu, move to the previous level in the OSD screen	
8	Navigation Buttons	◀	Press to decrease numerical values or select from several definitions.
		▲	Press to move up the menu list values.
		▶	Press to increase numerical values or select from several definitions.
		▼	Press to move down the menu list.
		Enter	Press to accept changes and change the SETUP parameters.
9	RESET TO XGA/1080P Button	Press and hold for about 2 seconds to toggle the output resolution between XGA and 1080p, alternatively.	
10	PANEL LOCK Button	To lock, press and hold PANEL LOCK button for about 3 seconds. To unlock, press and hold PANEL LOCK and RESET TO buttons for about 3 seconds.	

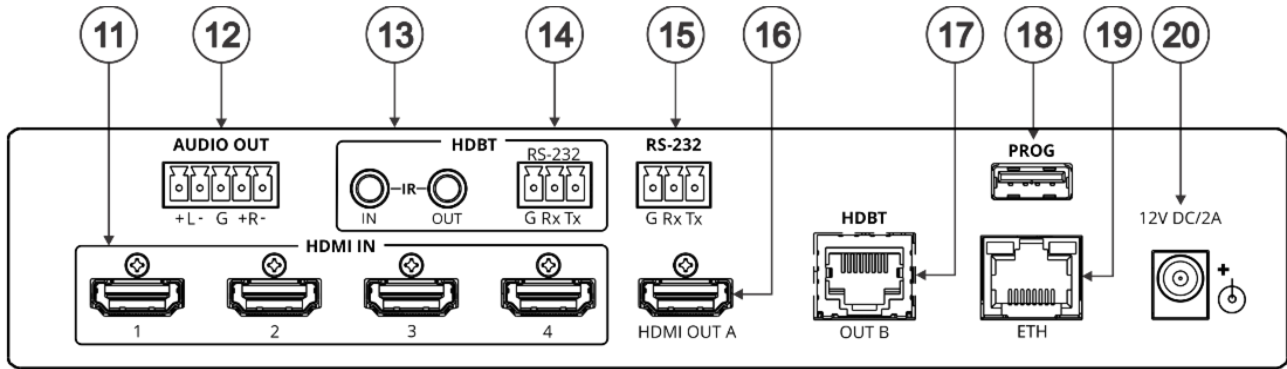

Figure 2: MV-4X 4 Window Multi-viewer/4x2 Seamless Matrix Switcher Front Panel

#	Feature	Function
11	HDMI IN Connectors (1 to 4)	Connect to up to 4 HDMI sources.
12	AUDIO OUT 5-pin Terminal Block Connector	Connect to a balanced stereo audio acceptor.
13	HDBT IR IN RCA Connector	Connect to an IR sensor to control a device connected to the HDBT receiver via IR Tunneling.
	HDBT IR OUT RCA Connector	Connect to an IR emitter to control a device that is connected to MV-4X from the HDBT receiver side via HDBT tunneling.
14	HDBT RS-232 3-pin Terminal Block Connector	Connect to a device for RS-232 HDBT tunneling.
15	RS-232 3-pin Terminal Block Connector	Connect to a PC to control the MV-4X .
16	HDMI OUT A Connector	Connect to an HDMI acceptor.
17	HDBT OUT B RJ-45 Connector	Connect to a receiver (for example, TP-580Rxr).
18	PROG USB Connector	Connect to a USB stick to perform firmware upgrades and/or upload a Logo.
19	ETHERNET RJ-45 Connector	Connect to a PC via a LAN
20	12V/2A DC Connector	Connect to the supplied power adapter.

The terms HDMI, HDMI High-Definition Multimedia Interface, and the HDMI Logo are trademarks or registered trademarks of HDMI Licensing Administrator, Inc.

Mounting MV-4X

This section provides instructions for mounting **MV-4X**. Before installing, verify that the environment is within the recommended range:



- Operation temperature – 0° to 40°C (32 to 104°F).
- Storage temperature – -40° to +70°C (-40 to +158°F).
- Humidity – 10% to 90%, RHL non-condensing.

**Caution:**

- Mount **MV-4X** before connecting any cables or power.

**Warning:**

- Ensure that the environment (e.g., maximum ambient temperature & air flow) is compatible for the device.
- Avoid uneven mechanical loading.
- Appropriate consideration of equipment nameplate ratings should be used for avoiding overloading of the circuits.
- Reliable earthing of rack-mounted equipment should be maintained.
- Maximum mounting height for the device is 2 meters.

Mount MV-4X in a rack:

- Use the recommended rack adapter
(see www.kramerav.com/product/MV-4X).

Attach the rubber feet and place the unit on a flat surface.

Connecting MV-4X



Always switch off the power to each device before connecting it to your **MV-4X**. After connecting your **MV-4X**, connect its power and then switch on the power to each device.

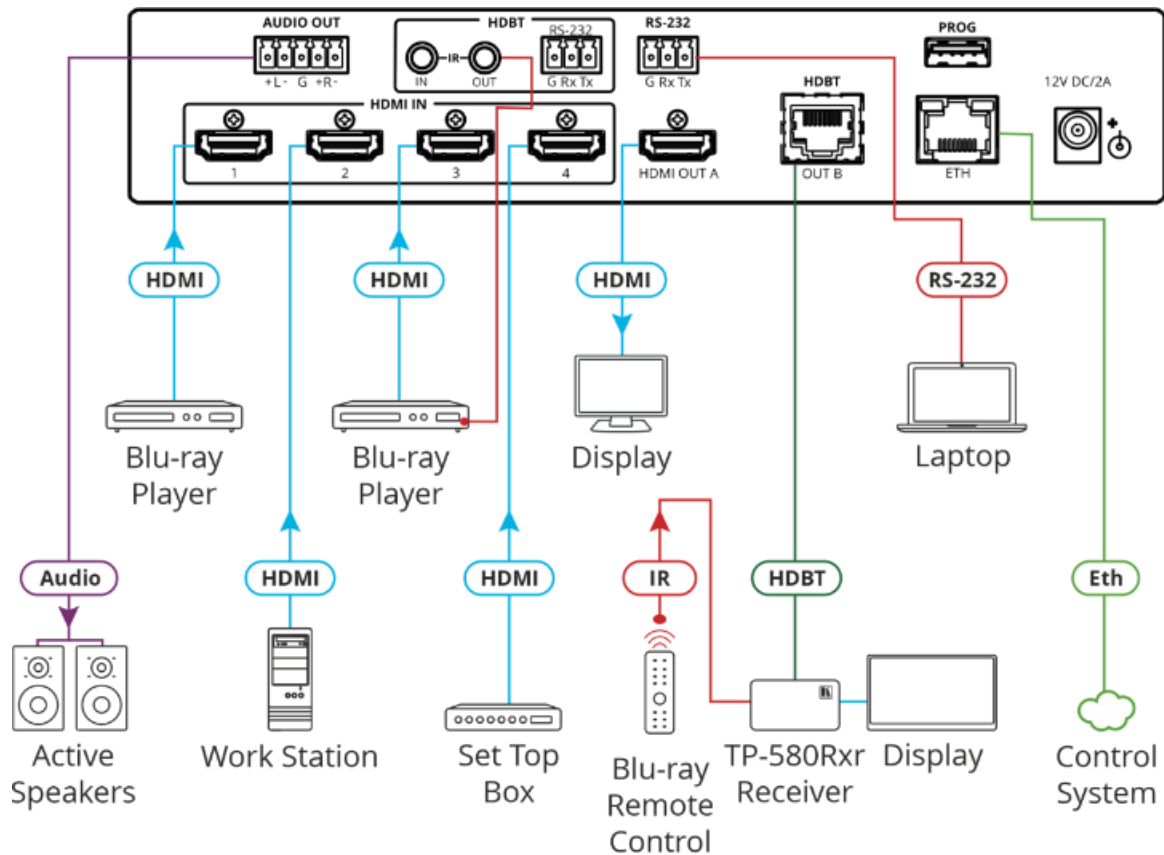

Figure 3: Connecting to the MV-4X Rear Panel

To connect **MV-4X** as illustrated in the example in [Figure 3](#):

1. Connect up to 4 HDMI sources (for example, Blu-ray players, a work station and set top box) to the HDMI IN connectors (11).
2. Connect the HDMI OUT A connector (16) to an HDMI acceptor (for example, a display).
3. Connect the HDBT OUT B RJ-45 port (17) to a Receiver (for example, Kramer **TP-580Rxr**).
4. Connect the AUDIO OUT 5-pin Terminal block connector (12) to balanced stereo audio active speakers.
5. Set IR control from the connected receiver to the Blue-ray player that is connected to HDMI IN 3 (by pointing the Blue-ray IR remote control to the IR receiver):
 - Connect an IR receiver cable to the **TP-580Rxr** receiver.
 - Connect an IR emitter cable from the IR OUT RCA connector to the IR receiver on the Blue-ray player.
6. Connect the RS-232 3-pin terminal block connector to a laptop.
7. Connect the power adapter to **MV-4X** and to the mains electricity (not shown in [Figure 3](#)).

Connecting the Output to a Balanced/Unbalanced Stereo Audio Acceptor

The following are the pinouts for connecting the output to a balanced or unbalanced stereo audio acceptor:

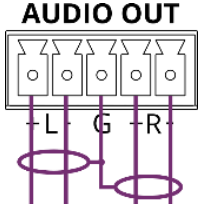

Figure 4: Connecting to a Balanced Stereo Audio Acceptor

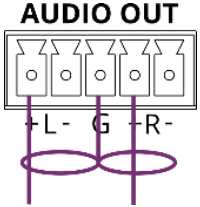

Figure 5: Connecting to an Unbalanced Stereo Audio Acceptor

Connecting to MV-4X via RS-232

You can connect to MV-4X via an RS-232 connection (13) using, for example, a PC.

MV-4X features an RS-232 3-pin terminal block connector allowing the RS-232 to control MV-4X.

Connect an RS-232 terminal block on the rear panel of MV-4X to a PC/controller, as follows:

From the RS-232 9-pin D-sub serial port connect:

- Pin 2 to the TX pin on the MV-4X RS-232 terminal block
- Pin 3 to the RX pin on the MV-4X RS-232 terminal block
- Pin 5 to the G pin on the MV-4X RS-232 terminal block

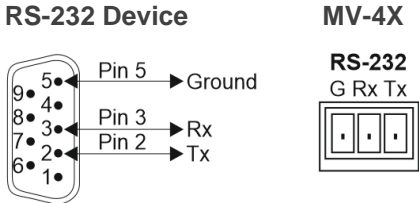

Wiring RJ-45 Connectors

This section defines the TP pinout, using a straight pin-to-pin cable with RJ-45 connectors.

i For HDBT cables, it is recommended that the cable ground shielding be connected/soldered to the connector shield.

EIA /TIA 568B	
PIN	Wire Color
1	Orange / White
2	Orange
3	Green / White
4	Blue
5	Blue / White
6	Green
7	Brown / White
8	Brown

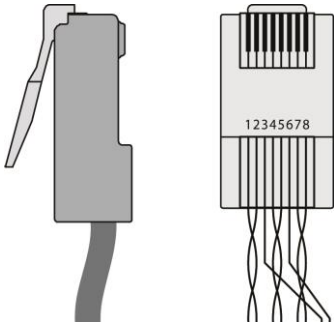

Operating and Controlling MV-4X

Using Front Panel Buttons

MV-4X front panel buttons enable the following actions:

- Selecting an HDMI INPUT ①.
- Selecting an output (A or B) ②.
- Directing an input to a selected window using the WINDOW button ③ and the INPUT buttons (from 1 to 4) ①.
- Selecting operation modes (MATRIX ④, QUAD ⑤ or PIP ⑥ modes).
- Controlling and operating MV-4X via the OSD menu buttons (⑦ and ⑧).
- Resetting the resolution (to XGA/1080p) ⑨.
- Locking the front panel ⑩.

Controlling and Operating Via the OSD Menu

MV-4X enables controlling and defining the device parameters via the OSD, using the front panel MENU buttons.

To enter and use the OSD menu buttons:

1. Press MENU.
2. Press:
 - **ENTER** to accept changes and to change the menu settings.
 - **Arrow buttons** to move through the OSD menu, which is displayed on the video output.
 - **EXIT** to exit the menu.



The default OSD timeout is set to 10 seconds.

Use the OSD menu to perform the following operations:

- [Setting the Video Mode](#) on page [11](#).
- [Selecting the Window Layout Mode](#) on page [12](#).
- [Configuring Chroma Key Mode](#) on page [13](#).
- [Setting up the Picture Parameters](#) on page [14](#).
- [Defining the Audio Output](#) Settings on page [14](#).
- [Setting the Input](#) EDID on page [15](#).
- [Configuring HDCP Mode](#) on page [16](#).

- [Setting OSD Parameters](#) on page [17](#).
- [Configuring the Logo Settings](#) on page [18](#).
- [Setting Ethernet Parameters](#) on page [19](#).
- [Setting the Preset Parameters](#) on page [20](#).
- [Configuring the Setup](#) on page [20](#).
- [Viewing the Information](#) on page [21](#).

Setting the Video Mode

MV-4X enables setting the video operation mode.

To set the video mode:

1. On the front panel press **MENU**. The OSD menu appears.
2. Click **Video Mode**, select:
 - **Matrix**, and perform the following actions:

Menu Item	Action	Options
Fade In/Out	Enable or disable crossfading between sources in Matrix mode.	On, Off (default)
Fade Speed	Set the fade speed (in seconds).	1~10 (5 default)
OUT A/B Source	Select the source for output A (HDMI) and output B (HDBT).	INPUT 1~4 (IN 1 default)

- **PiP, PoP or Quad**, and perform the following actions:

Menu Item	Action	Options	
WIN 1/2/3/4 Source	Select the source for the specified window. The selected configuration is routed to output A and output B.	WIN 1 Source	In 1~4 (IN 1 default)
		WIN 2 Source	In 1~4 (IN 2 default)
		WIN 3 Source	In 1~4 (IN 3 default)
		WIN 4 Source	In 1~4 (IN 4 default)

- **Auto** (see also [Defining the Auto-Layout Parameters](#) on page [40](#)), and perform the following actions:

Menu Item	Action	Options
WIN 1 to WIN 4	View the number of active windows.	2 options are displayed: An active source is present, for example, WIN 1>INPUT 2. There is currently no active source: Window Off.
Auto Layout		Full screen
Auto Layout 2	Select the preferred window arrangement to use in Auto mode when there are 2 active sources.	Side by Side (default), PoP or PiP
Auto Layout 3	Select the preferred window arrangement to use in Auto mode when there are 3 active sources.	PoP Side or PoP Bottom
Auto Layout 4	Select the preferred window arrangement to use in Auto mode when there are 4 active sources.	Quad, PoP Side or PoP Bottom

- **Preset 1, Preset 2, Preset 3, or Preset 4** (see [Configuring/Recalling a Preset](#) on page [39](#)).

Selecting the Window Layout Mode

MV-4X enables selecting the window layout for a specific video mode (see [Setting the Video Mode](#) on page 11).



All settings are individually saved for each window and each mode.

To set the window layout mode:

1. On the front panel press **MENU**. The menu appears.
2. Click **Window Layout**.
3. Select an input:
 - When in **Matrix** mode, select an input and perform the following actions:

Menu Item	Action	Options
Aspect Ratio	Select a fixed aspect ratio for the currently selected window. Full stretches the source to fill the output, regardless of original aspect. Best Fit automatically sets the ratio based on the window's current source resolution.	Full (default), 16:9, 16:10, 4:3, Best Fit
Mirror	Select Yes to flip the currently selected input horizontally.	No (default), Yes
Rotate	Enable or disable rotating the input counterclockwise by 90, 180 or 270 degrees. When rotation is active, the output is forced to full screen and the mirror and border settings are disabled. When the output resolution is set to 4K, only input 1 can be rotated.	Off (default), 90 degrees, 180 degrees, 270 degrees
Border On/Off	Enable or disable the color border around the currently selected input.	On, Off (default)
Border Color	Select the color to use for the border of the currently selected input.	Black, Red, Green (Win1 default), Blue (Win 2 default), Yellow (Win 3 default), Magenta (Win 4 default), Cyan, White, Dark Red, Dark Green, Dark Blue, Dark Yellow, Dark Magenta, Dark Magenta, Dark Cyan or Gray
Window Reset	Reset the current input to its default settings.	No (default), Yes

- When in **PiP/PoP/Quad** mode, select a window and perform the following actions:

Menu Item	Action	Options
Window On/Off	Enable or disable the currently selected window.	On (default), Off
Position X	Set the X coordinate position of the upper left corner of the currently selected window.	0~Max H Resolution
Position Y	Set the coordinate position of the upper left corner of the currently selected window.	0~Max V Resolution
Size Width	Set the width of the currently selected window.	1~Max H Resolution

Menu Item	Action	Options
Size Height	Set the height of the currently selected window.	1~Max V Resolution
Priority	Select the layer priority of the currently selected window. Priority 1 is at the front and priority 4 is at the back.	Win 1 (layer 4, default), Win 2 (layer 3, default), Win 3 (layer 2, default), Win 4 (layer 1, default)
Aspect Ratio	Select a fixed aspect ratio for the currently selected window. The aspect ratio is based on the window's current height. Full returns the window to the current mode's default size and shape for that window. Best Fit automatically sets the ratio based on the window's current source resolution.	Full (default), 16:9, 16:10, 4:3, Best Fit, User
Mirror (Horizontal)	Select Yes to flip the currently selected input horizontally.	No (default), Yes
Border On/Off	Enable or disable the color border around the currently selected window.	On, Off (default)
Border Color	Select the color to use for the border of the currently selected window.	Black, Red, Green (Win1 Default), Blue (Win 2 Default), Yellow (Win 3 Default), Magenta (Win 4 Default), Cyan, White, Dark Red, Dark Green, Dark Blue, Dark Yellow, Dark Magenta, Dark Magenta, Dark Cyan or Gray
Window Reset	Reset the current window to its default settings.	No (default), Yes

Configuring Chroma Key Mode

MV-4X enables you to control the chroma key functions of the unit. Several pre-designed standard key ranges are provided as well as slots to save up to 4 user-created key ranges. Keying values and ranges are set using the full RGB color space (0~255).



Chroma Key is supported in Matrix Mode only.

To start the Chroma Key mode:

1. On the front panel press **MENU**. The menu appears.
2. Click **Chroma Key** and perform the following actions:

Menu Item	Action	Options				
Chroma Key	Select On to activate chroma keying. When Chroma Key is active the aspect ratio is forced to full screen and the border feature is disabled.	On, Off (default)				
User Select	Select the keying preset to use when chroma key is active.	User 1 (default), User 2, User 3, User 4, White, Yellow, Cyan, Green, Magenta, Red, Blue, Black				
Red/Green/Blue Max/Min:	Set the keying range (the color range within the IN 2 video to make it	<table border="1"> <tr> <td>Red Max</td> <td>0~255 (255 default)</td> </tr> <tr> <td>Red Min</td> <td>0~255 (0 default)</td> </tr> </table>	Red Max	0~255 (255 default)	Red Min	0~255 (0 default)
Red Max	0~255 (255 default)					
Red Min	0~255 (0 default)					

Menu Item	Action	Options	
	transparent) to use for the currently selected User Key Preset by setting the maximum and minimum values for red, green, and blue. If a fixed preset is currently selected, the values are displayed, but cannot be modified.	Green Max	0~255 (255 default)
		Green Min	0~255 (0 default)
		Blue Max	0~255 (255 default)
		Blue Min	0~255 (0 default)

Chroma key is now configured.

Setting up the Picture Parameters

MV-4X enables setting the image parameters.

To set the picture parameters:

1. On the front panel press **MENU**. The menu appears.
2. Click **Picture**.
3. Select an input and perform the following actions:

Menu Item	Action	Options	
Contrast	Set the contrast.	0, 1, 2, ...100 (default 75)	
Brightness	Set the brightness.	0, 1, 2, ...100 (default 50)	
Saturation	Set the saturation.	0, 1, 2, ...100 (default 50)	
Hue	Set the hue.	0, 1, 2, ...100 (default 50)	
Sharpness H/V	Set the H/V sharpness.	H Sharpness	0, 1, 2, ...20 (default 10)
		V Sharpness	0, 1, 2, ...20 (default 10)
Reset	Set the sharpness.	No (default), Yes	

Picture parameters are set.

Defining the Audio Output Settings

MV-4X enables defining the device audio output settings.

To define the Audio output settings:

1. On the front panel press **MENU**. The menu appears.
2. Click **Audio** and define the video parameters according to the information in the following table:
 - Audio: Matrix Mode

Menu Item	Action	Options
OUT A Source	Select the audio source to pair with video output A.	IN 1 (default), IN 2, IN 3, IN 4, Window
OUT A Mute	Enable or disable muting audio output A.	On, Off (default)
OUT B Source	Select the audio source to pair with video output B.	IN 1, IN 2, IN 3, IN 4, Win 1 (default), Win 2, Win 3, Win 4
OUT B Mute	Enable or disable muting audio output B.	On, Off (default)

- Audio: PiP/PoP/Quad/Auto

Menu Item	Action	Options
OUT A Source	Select the audio source to pair with video output A.	IN 1, IN 2, IN 3, IN 4, Win 1 (default), Win 2, Win 3, Win 4
OUT A Mute	Enable or disable muting audio output A.	On, Off (default)
OUT B Source	Select the audio source to pair with video output B.	IN 1, IN 2, IN 3, IN 4, Win 1 (default), Win 2, Win 3, Win 4
OUT B Mute	Enable or disable muting audio output B.	On, Off (default)

Audio outputs are set.

Setting the Input EDID

MV-4X enables assigning the EDID to all the inputs at once or to each input separately. User EDID can be uploaded via the PROG USB port using a memory stick.

To set the EDID parameters

1. On the front panel press **MENU**. The menu appears.
2. Click **Input EDID Section** and set the EDID according to the information in the following table:

Menu Item	Action	Options
EDID Mode	Select how to assign the EDID to the device inputs: Select All for a single EDID to be assigned to all the inputs. Select Appoint for a different EDID to be assigned to each input.	All (default), Appoint
All EDID	When in All EDID mode, assign the selected EDID to all the inputs.	1080P (default), 4K2K3G, 4K2K420, 4K2K6G, Sink Output A, Sink Output B, User 1, User 2, User 3, User 4
In 1~4 EDID	When in Appoint EDID mode, assign a selected EDID individually for each input (IN EDID from 1 to 4).	1080P (default), 4K2K3G, 4K2K420, 4K2K6G, Sink Output A, Sink Output B, User 1, User 2, User 3, User 4
User 1~4 Update	Update the USER EDID: <ul style="list-style-type: none"> • Copy the desired EDID file (EDID_USER_*.BIN) to the root directory of a USB memory stick • Select Yes for a selected User. • Insert the USB memory stick into the PROG USB port on the rear panel. The EDID stored in the memory stick uploads automatically.	For each User: No (default), Yes

Input EDID is set.

Configuring HDCP Mode

MV-4X enables configuring HDCP on the inputs and outputs.

To configure the HDCP mode:

1. On the front panel press **MENU**. The menu appears.
2. Click **HDCP Mode** and define the video parameters according to the information in the following table:

Menu Item	Description	Options
IN 1~4	Select the HDCP behavior for each input. Select Off to disable HDCP support on the selected input.	Off, On (default)
OUT A/OUT B	Set the HDMI output to follow Input or Output .	Follow Output (default), Follow Input

HDCP is configured.

Setting the Output Resolution Parameters

MV-4X enables setting output parameters such as the size of the image and output resolution via the OSD MENU buttons.



OUT A and OUT B have the same resolution.

To set the output parameters:

1. On the front panel press **MENU**. The menu appears.
2. Click **Output Resolution** and define resolution

Menu Item	Function			
Resolution	Select the video output resolution. 1920x1080p60 is the default resolution.			
	Native OUT A	1280x800p60	1920x1080p25	4096x2160p30
	Native OUT B	1280x960p60	1920x1080p30	4096x2160p50
	480p60	1280x1024p60	1920x1080p50	4096x2160p59
	576p50	1360x768p60	1920x1080P60	4096x2160p60
	640x480p59	1366x768p60	1920x1200RB	3840x2160p50
	800x600p60	1400x1050p60	2048x1152RB	3840x2160p59
	848x480p60	1440x900p60	3840x2160p24	3840x2160p60
	1024x768p60	1600x900p60RB	3840x2160p25	3840x2400p60RB
	1280x720p50	1600x1200p60	3840x2160p30	
	1280x720p60	1680x1050p60	4096x2160p24	
	1280x768p60	1920x1080p24	4096x2160p25	

The output resolution is set.

Setting OSD Parameters

MV-4X enables adjusting OSD MENU parameters.

To set the OSD parameters:

1. On the front panel press **MENU**. The menu appears.
2. Click **OSD Settings** and define the OSD parameters according to the information in the following table:

Menu Item	Action	Options
Menu Position	Set the position of the OSD menu on the output.	Top Left (default), Top Right, Bottom Right, Bottom Left
Menu Timeout	Set the OSD timeout in seconds or set to off to always display the OSD.	Off (Always on), 5~60 (in 1sec steps) (10 default)
Info. Timeout	Set the Info. timeout in seconds or set to off to always display the OSD.	Off (Always on), 5~60 (in 1sec steps) (10 default)
Info. Display	Enable or disable the appearance of information on the display.	On (default), Off
Transparency	Set the transparency level of the background of the OSD menu (10 means fully transparency).	Off (default), 1~10
Background	Set the color of the background of the OSD menu.	Black, Gray (default), Cyan
Text Color	Set the OSD text color	White (default), Yellow, Magenta

OSD parameters are set.

Configuring the Logo Settings

MV-4X enables uploading and managing a Logo to appear on the screen.

To configure the logo:

1. On the front panel press **MENU**. The menu appears.
2. Click **Logo Settings** and define the Logo settings according to the information in the following table:

Menu Item	Action	Options
Logo On/Off	Enable / disable displaying a logo graphic.	On, Off (default)
Position X/Y	Set the horizontal and vertical position of the logo's upper left corner, within the output. The position values are a relative percentage of the available output resolution.	Position X 0~100 (10 default)
		Position Y 0~100 (10 default)
OSD Logo Reset	Select Yes to reset the logo and install a default test image. The reset process can take a few minutes. Progress information is displayed on the OSD while the default logo is being installed. The unit automatically reboots when installation is complete.	Yes, No (default)
Logo Update	Update the Logo: <ul style="list-style-type: none"> • Copy the desired Logo file (LOGO_USER_*.BMP) to the root directory of a USB memory stick. The new logo graphic file should be 8-bit *.BMP format with a max resolution of 960x540. • Select Yes. • Insert the USB memory stick into the PROG USB port on the rear panel. The logo stored in the memory stick uploads automatically.	Yes, No (default)
Boot Logo Display	Enable / disable displaying a graphic image during boot up.	On (default), Off
Boot 4K Source	Select the Default Logo image or the User uploaded image while booting, when output resolution is \geq 4k.	Default (default), User
Boot 1080P Source	Select the Default Logo image or the User uploaded image while booting, when output resolution is between 1080p and VGA.	Default (default), User
Boot VGA Source	Select the Default Logo image or the User uploaded image while booting, when output resolution is \leq VGA.	Default (default), User
User 4K Update	To upload a User 4K boot graphic via USB: <ul style="list-style-type: none"> • Copy the desired Logo file (LOGO_BOOT_4K_*.BMP) to the root directory of a USB memory stick. The new logo graphic file should be 8-bit *.BMP format with a resolution of 1920x1080. • Select Yes. • Insert the USB memory stick into the PROG USB port on the rear panel. The 4K logo stored in the memory stick uploads automatically.	Yes, No (default)

Menu Item	Action	Options
User 1080P Update	<p>To upload a User 1080p boot graphic via USB:</p> <ul style="list-style-type: none"> • Copy the desired Logo file (LOGO_BOOT_1080P_*.BMP) to the root directory of a USB memory stick. The new logo graphic file should be 8-bit *.BMP format with a resolution of 3840x2160. • Select Yes. • Insert the USB memory stick into the PROG USB port on the rear panel. <p>The 1080p logo stored in the memory stick uploads automatically.</p>	Yes, No (default)
User VGA Update	<p>To upload a User VGA boot graphic via USB:</p> <ul style="list-style-type: none"> • Copy the desired Logo file (LOGO_BOOT_VGA_*.BMP) to the root directory of a USB memory stick. The new logo graphic file should be 8-bit *.BMP format with a resolution of 640x480. • Select Yes. • Insert the USB memory stick into the PROG USB port on the rear panel. <p>The VGA logo stored in the memory stick uploads automatically.</p>	Yes, No (default)

Logo Settings are configured.

Setting Ethernet Parameters

MV-4X enables defining the Ethernet parameters via the MENU buttons.

When **MV-4X** is in Static IP mode, the IP address, netmask and gateway addresses may be manually set, and changes occur immediately.

When **MV-4X** is set to DHCP mode, the unit's current IP configuration and the unit's MAC address is displayed under Link Status.

To set the Ethernet parameters:

1. On the front panel press **MENU**. The menu appears.
2. Click **Ethernet** and define Ethernet parameters according to the information in the following table:

Menu Item	Action	Options
IP Mode	Set the device Ethernet settings to Static or DHCP .	DHCP, Static (default)
IP Address (Static Mode)	Set the IP address.	x.x.x.x (192.168.1.39 default)
Subnet Mask (Static Mode)	Set the subnet mask.	x.x.x.x (255.255.0.0 default)
Gateway (Static Mode)	Set the gateway.	x.x.x.x (192.168.0.1 default]

Network parameters are defined.

Setting the Preset Parameters

MV-4X enables storing and recalling up to 4 presets via the OSD or the embedded web pages (see [Saving Presets](#) on page 31 and [Configuring/Recalling a Preset](#) on page 39).

Presets include the window position, routing state, window source, window layer, aspect ratio, border and border color, rotation state and window state (enabled or disabled).

To store/recall a preset:

1. Set the device to the desired configuration.
2. On the front panel press **MENU**. The menu appears.
3. Click **Preset** and perform the following actions according to the information in the following table:

Menu Item	Action	Options
Save	Select a preset and Press Enter .	Preset1 (default), Preset2, Preset3, Preset4
Recall	Select a Preset and Press Enter .	Preset1 (default), Preset2, Preset3, Preset4

Presets are stored/recalled.

Configuring the Setup

To configure the Setup:

1. On the front panel press **MENU**. The menu appears.
2. Click **Setup** and define the settings according to the information in the following table:

Menu Item	Function	Options
Auto Sync Off	Set the amount of time to continue outputting sync with a black screen if there are no live sources and no operations executed on the device.	Off (default), Fast, Slow, Immediate
Firmware Update	To upgrade the firmware via USB: <ul style="list-style-type: none"> • Copy new firmware file (*.BIN) to the root directory of a USB memory stick. • Select Yes. • Insert the USB memory stick into the PROG USB port on the rear panel. The new firmware uploads automatically.	Yes, No (default)
User EDID Reset	Select Yes to reset the device User EDIDs to their factory default states.	Yes, No (default)
Factory Reset	Select Yes to reset the device to its factory default parameters.	Yes, No (default)
User Boot Logo Clear	Select Yes to remove all user uploaded boot graphics.	Yes, No (default)
AS OUT A/B	Set auto switching status for output A/B: Select Off for manual switching. Select Auto Scan to switch a valid input when no signal is found on the selected input. Select Last Connected to automatically switch to the last connected input and revert to the previously selected input after that input is lost.	Off (default), Auto Scan, Last Connected
HDR On/Of	Set HDR to On or Off	On, Off (default)

Menu Item	Function	Options
Key Lock	Define which buttons are disabled when pressing the PANEL LOCK button on the front panel. When selecting Save modes, the front panel remains locked after power up of the device.	All, Menu Only, All & Save, Menu Only & Save
Output A Mode	Set the HDMI output format.	HDMI (default), DVI
Output B Mode	Set the HDBT output format.	HDMI (default), DVIId

Setup configuration is complete

Viewing the Information

Shows the currently detected details for all inputs and both outputs as well as listing the status of a few critical system settings and applicable firmware versions.

To view the Information:

1. On the front panel press **MENU**. The menu appears.
2. Click **Information** and view the information in the following table:

Menu Item	View
IN 1~4 Source Resolution	Current Input Resolutions.
Output Resolution	Current Output Resolutions.
Video Mode	Current Mode.
Sink A~B Native Resolution	Native resolution as reported by EDID.
Firmware	Current Firmware Version.
Lifetime	Current machine lifetime in hours.

Information is viewed.

Operating via Ethernet

You can connect to **MV-4X** via Ethernet using either of the following methods:

- Directly to the PC using a crossover cable (see [Connecting Ethernet Port Directly to a PC](#) on page 21).
- Via a network hub, switch, or router, using a straight-through cable (see [Connecting Ethernet Port via a Network Hub](#) on page 24).

Note: If you want to connect via a router and your IT system is based on IPv6, speak to your IT department for specific installation instructions.

Connecting Ethernet Port Directly to a PC

You can connect the Ethernet port of **MV-4X** directly to the Ethernet port on your PC using a crossover cable with RJ-45 connectors.



This type of connection is recommended for identifying **MV-4X** with the factory configured default IP address.

After connecting **MV-4X** to the Ethernet port, configure your PC as follows:

1. Click **Start > Control Panel > Network and Sharing Center**.
2. Click **Change Adapter Settings**.
3. Highlight the network adapter you want to use to connect to the device and click **Change settings of this connection**.

The Local Area Connection Properties window for the selected network adapter appears as shown in [Figure 6](#).

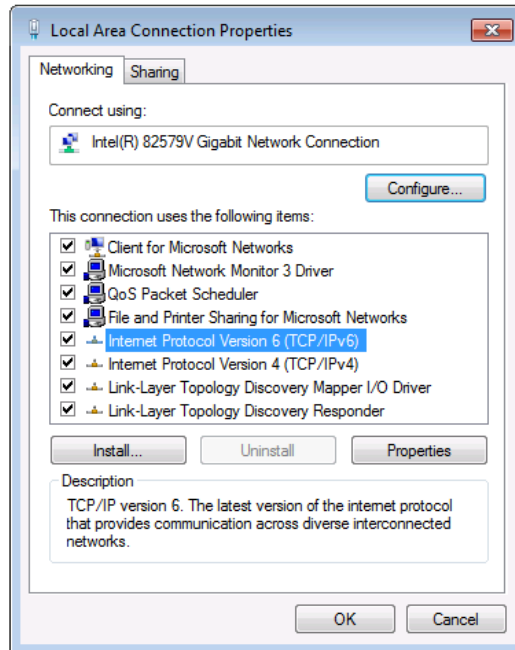

Figure 6: Local Area Connection Properties Window

4. Highlight either **Internet Protocol Version 6 (TCP/IPv6)** or **Internet Protocol Version 4 (TCP/IPv4)** depending on the requirements of your IT system.
5. Click **Properties**.

The Internet Protocol Properties window relevant to your IT system appears as shown in [Figure 7](#) or [Figure 8](#).

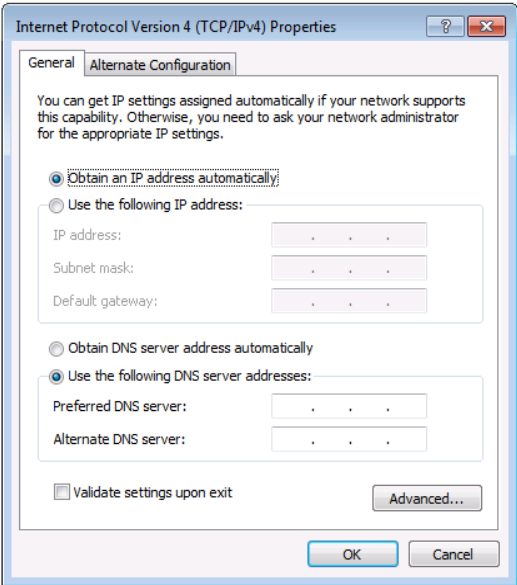

Figure 7: Internet Protocol Version 4 Properties Window

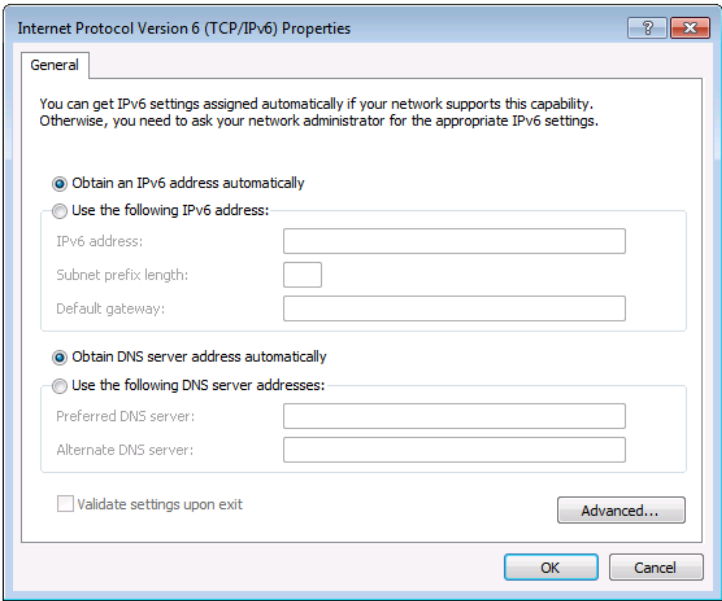

Figure 8: Internet Protocol Version 6 Properties Window

- 6. Select **Use the following IP Address** for static IP addressing and fill in the details as shown in [Figure 9](#).
For TCP/IPv4 you can use any IP address in the range 192.168.1.1 to 192.168.1.255 (excluding 192.168.1.39) that is provided by your IT department.

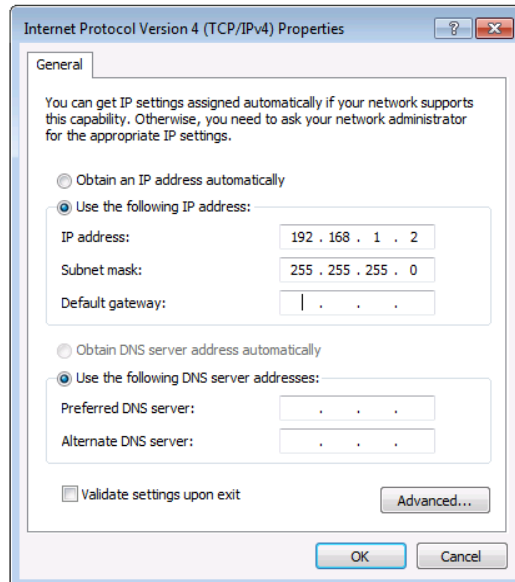

Figure 9: Internet Protocol Properties Window

7. Click **OK**.
8. Click **Close**.

Connecting Ethernet Port via a Network Hub or Switch

You can connect the Ethernet port of **MV-4X** to the Ethernet port on a network hub or using a straight-through cable with RJ-45 connectors.

Using Embedded Web Pages

MV-4X enables you to configure settings via Ethernet using built-in, user-friendly web pages. The Web pages are accessed using a Web browser and an Ethernet connection.

 You can also configure **MV-4X** via Protocol 3000 commands (see [Protocol 3000 Commands](#) on page 60).

Before attempting to connect:

- Perform the procedure in (see [Operating via Ethernet](#) on page 21).
- Ensure that your browser is supported.

The following operating systems and Web browsers are supported:

Operating Systems	Browser
Windows 7	Firefox
	Chrome
	Safari
Windows 10	Edge
	Firefox
	Chrome
Mac	Safari
iOS	Safari
Android	N/A

 If a web page does not update correctly, clear your Web browser's cache.

To access the web pages:

1. Enter the IP address of the device in the address bar of your internet browser (default = 192.168.1.39).

If security is enabled, the Login window appears.

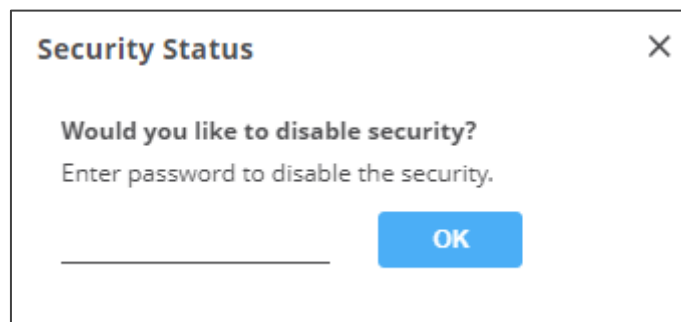





Figure 10: Embedded Web Pages Login Window

2. Enter the Username (default = admin) and Password (default = admin) and click **Sign in**. The default web page appears.

On the webpage top right-hand side, you can press:

- , to access stand-by mode.
- , to set web page security.
- , to enlarge web page view to full page.

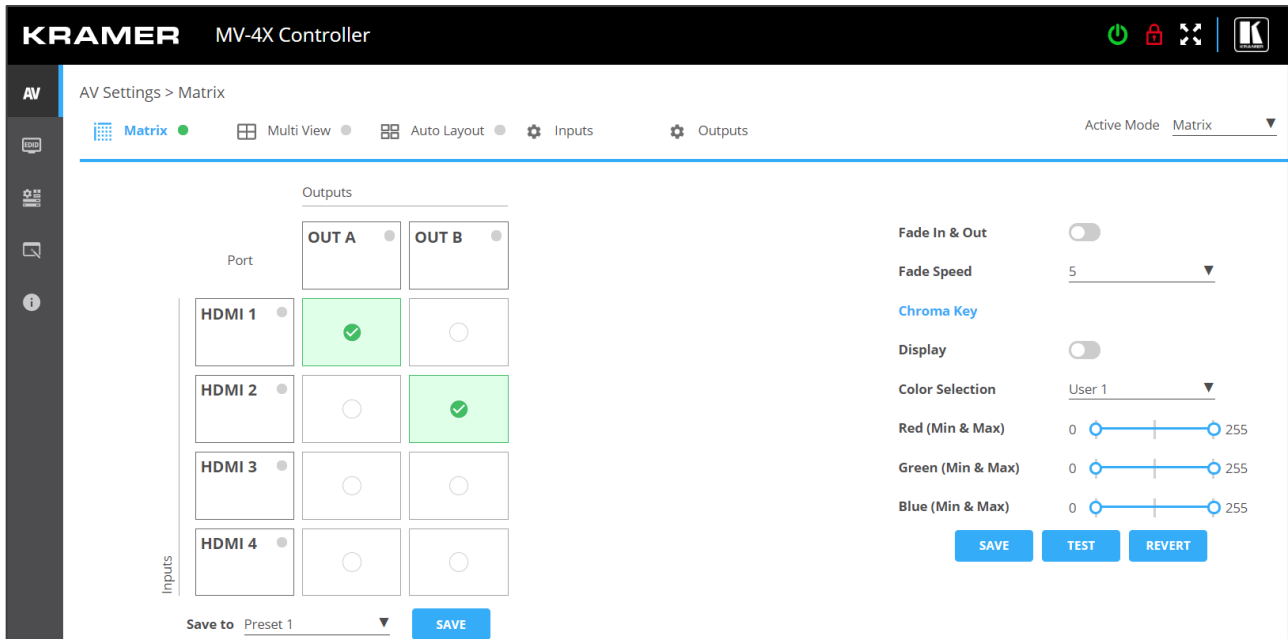

Figure 11: AV Settings Page

3. Click the Navigation Pane on the left side of the screen to access the relevant web page.

MV-4X web pages enable performing the following actions:

- [General Operation Settings](#) on page [27](#).
- [Defining the Matrix Mode Parameters](#) on page [31](#).
- [Defining the Multi-View Parameters](#) on page [34](#).
- [Defining the Auto-Layout Parameters](#) on page [40](#).
- [Managing EDID](#) on page [41](#).
- [Defining General Settings](#) on page [44](#).
- [Defining Interface Settings](#) on page [46](#).
- [Defining MV-4X User Access](#) on page [47](#).
- [Defining Advanced Settings](#) on page [48](#).
- [Defining OSD Settings](#) on page [51](#).
- [Configuring a Logo](#) on page [52](#).
- [Viewing the About Page](#) on page [54](#).

General Operation Settings

MV-4X operation modes can be defined via the embedded web pages. In the AV Settings page, the upper section is visible and provides control over the device operational modes, source selection, and output resolution.

MV-4X enables performing the following actions:

- [Setting the Active Operation Mode](#) on page [27](#).
- [Adjusting Input Parameters](#) on page [28](#).
- [Adjusting Output Parameters](#) on page [30](#).
- [Saving Presets](#) on page [31](#).

Setting the Active Operation Mode

Set the different operation mode parameters via the tabs in the AV Settings page, as described in the following sections.

Once defined, use the Active Mode drop-down box on the top right to select the operation mode to output to the acceptors.

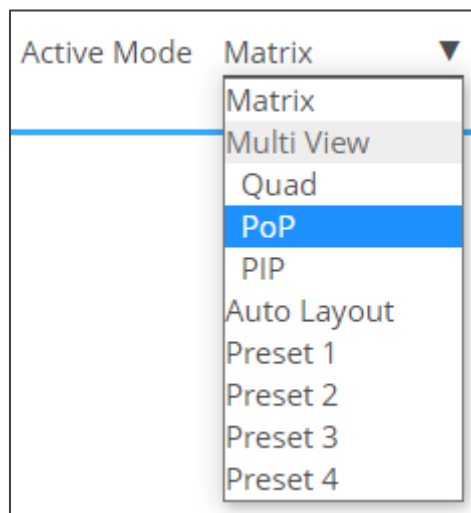

Figure 12: Selecting the Active Mode

Adjusting Input Parameters

For each operation mode you can adjust the input settings. Not all parameters are available for each operation mode.

To adjust input parameters:

1. Click **AV** on the Navigation List. The AV Settings page appears (see [Figure 11](#)).
2. Click **Inputs** tab.

The screenshot displays the 'AV Settings > Inputs' page for the Kramer MV-4X Controller. The interface is organized into a grid for four inputs. Each input column contains a 'Settings' section with various parameters and an 'Adjustments' section with sliders. The 'Settings' section includes: Label Name (text input), HDCP Mode (toggle), Aspect Ratio (dropdown), Mirror (toggle), Border (toggle), Border Color (dropdown), and Rotation (dropdown). Below the settings is a 'RESET TO DEFAULT' button. The 'Adjustments' section includes: Brightness, Contrast, Saturation, Hue, Sharpness H, and Sharpness V (sliders), and an 'Apply adjustments to all inputs' checkbox. Below the adjustments is an 'ADJUSTMENTS RESET' button. The top navigation bar shows 'Matrix' as the active mode.

Figure 13: AV Settings – Inputs Tab

3. For each input you can perform the following:
 - Change the input name.
 - Set HDCP on each input on (green) or off (gray).
 - Set the aspect ratio for each input.
 - Mirror the image horizontally (green).
 - Apply a Border to the image (green).
 - Set the Border color of the image from the drop-down box.
 - Rotate each input image independently by 90, 180 or 270 degrees.



To rotate the image, Aspect Ratio should be set to Full, and Mirror and Border features set to off.

For 4K output resolutions only input 1 can be rotated.

- If required, reset the settings to their default values.
4. For each input the sliders for each input to adjust the:
- Brightness
 - Contrast
 - Saturation
 - Hue
 - Sharpness H/V



If you need to make identical adjustments for all the inputs, check **Apply adjustments to all inputs** and adjust the video parameters on that input only. These parameters then apply to the other inputs.

- If required, reset adjustments to default settings.

Inputs are adjusted.

Adjusting Output Parameters

For each operation mode you can adjust the output settings. Not all parameters are available for each operation mode.

To adjust output parameters:

1. Click **AV** on the Navigation List. The AV Settings page appears (see [Figure 11](#)).
2. Click **Outputs** tab.

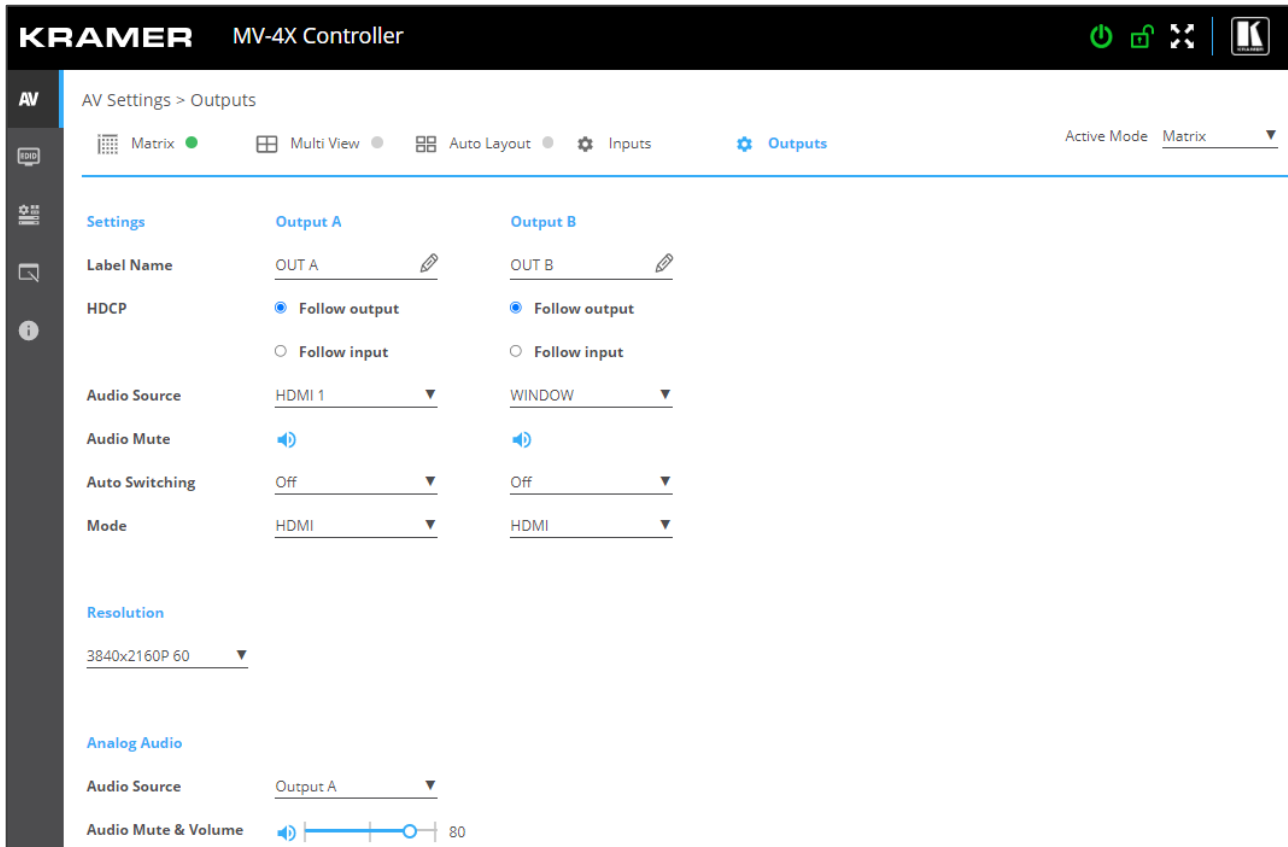

Figure 14: AV Settings – Outputs Tab

3. For each output:
 - Change the label name.
 - Set HDCP to Follow Input or Follow Output.
4. Select the audio source for each output:
 - HDMI 1 to 4: use the audio from the selected input.
 - WINDOW 1 to 4: use audio from the source that is currently displayed in the specified window.
5. Mute/unmute each output.
6. Select the auto switching mode (Off-Manual, Auto Scan or Last Connected).
7. Select audio source from HDMI or DVI (analog audio source).
8. Select the output resolution from the drop-down list.

9. Set the analog audio output source (Output A or Output B).
10. Adjust the audio output volume, or mute audio.

Outputs are adjusted.

Saving Presets

You can store up to 4 configuration presets. Presets can be recalled via the Multi-view tab (see [Defining the Multi-View Parameters](#) on page [34](#)).

Presets include the window position, routing state, window source, window layer, aspect ratio, border and border color, rotation state and window state (enabled or disabled).

To store a preset:

1. In the Navigation List, click **AV Settings**. The AV Settings page appears (see [Figure 16](#)).
2. From the top menu bar, select **Matrix**. The Matrix page appears and the gray indication to the right of the Matrix mode turns green.
3. Configure the operation mode settings.
4. From the **Save to** drop-down box, select a Preset.
5. Click **SAVE**.

A preset is saved.

Defining the Matrix Mode Parameters

MV-4X enables Configuring the Matrix Mode parameters and then switching inputs via seamless video cuts.

To set the inputs and outputs in the matrix mode see:

- [Adjusting Input Parameters](#) on page [28](#).
- [Adjusting Output Parameters](#) on page [30](#).



When HDR10 is used, some limitations may occur.

MV-4X enables performing the following actions in the Matrix mode:

- [Switching an input to an output](#) on page [31](#).
- [Defining Switching Fade In and Out Settings](#) on page [32](#).
- [Setting Chroma Key Parameters](#) on page [33](#).

Once defined, you can set the Matrix mode to the active mode.

Switching an input to an output

A green indication light next to an input or output indicates that an active signal is present on these ports.

To switch inputs to the outputs:

1. In the Navigation List, click **AV Settings**. The AV Settings page appears (see [Figure 16](#)).
2. From the top menu bar, select **Matrix**. The Matrix page appears and the gray indication to the right of the Matrix mode turns green.
3. Select an input-output cross-point (for example, between HDMI 1 and OUT B, and HDMI 4 and OUT A).

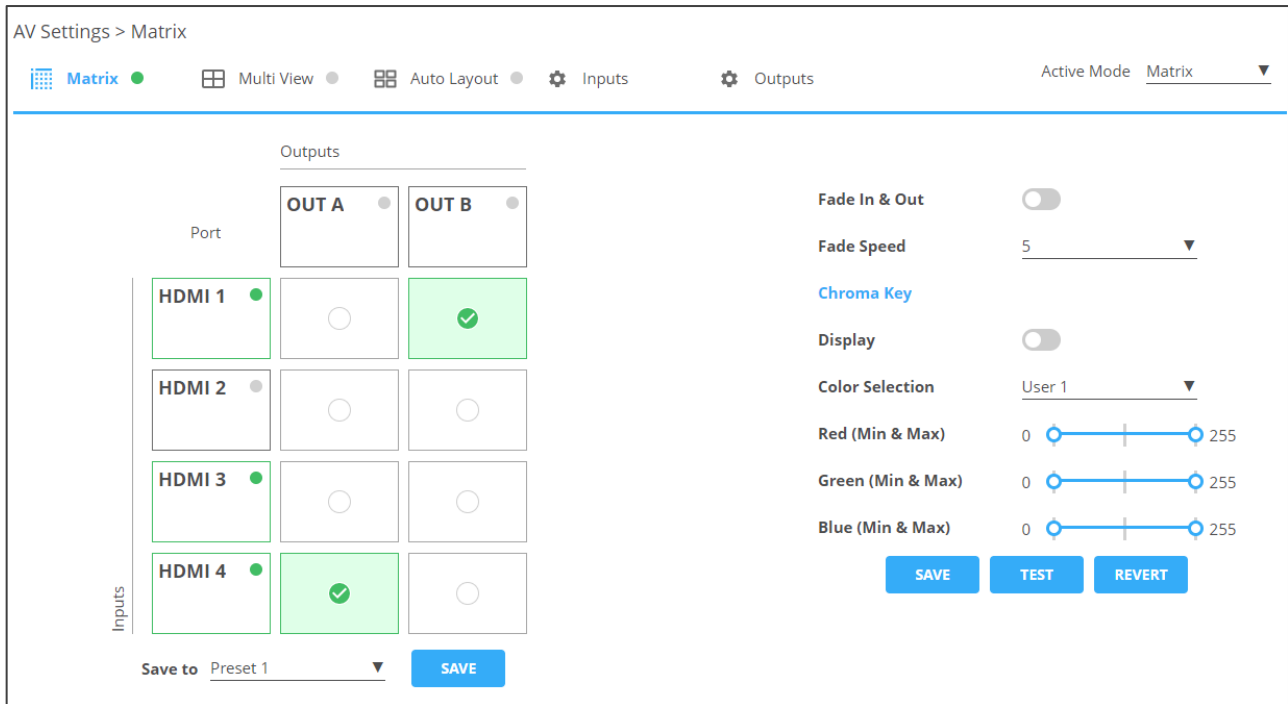

Figure 15: Matrix Page

Inputs are switched to the outputs.

Defining Switching Fade In and Out Settings

To define switching fade in/out:

1. In the Navigation List, click **AV Settings**. The AV Settings page appears.
2. From the top menu bar, select **Matrix**. The Matrix page appears and the gray indication to the right of the Matrix mode turns green.

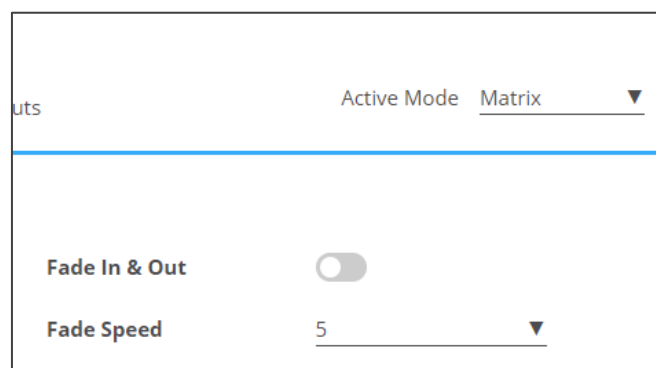

Figure 16: AV Settings Page – Matrix Mode Settings

3. Enable input Fade in & Out, using the slider on the side.

- If enabled, set the Fade Speed.



If Fade In & Out is enabled, Chroma Key is disabled and vice versa.

Fade In and Out time is defined.

Setting Chroma Key Parameters

MV-4X enables you to control the chroma key functions of the unit. Several pre-designed standard key ranges are provided as well as slots to save up to 4 user-created key ranges. Keying values and ranges are set using the full RGB color space (0~255).

Define chroma key settings via the Matrix mode tab.



When Chroma Key is active, both outputs will show the same video.

To set Chroma Key Parameters:

1. In the Navigation List, click **AV Settings**. The AV Settings page appears (see [Figure 11](#)).
2. From the top menu bar, select **Matrix**. The Matrix page appears and the gray indication to the right of the Matrix mode turns green.

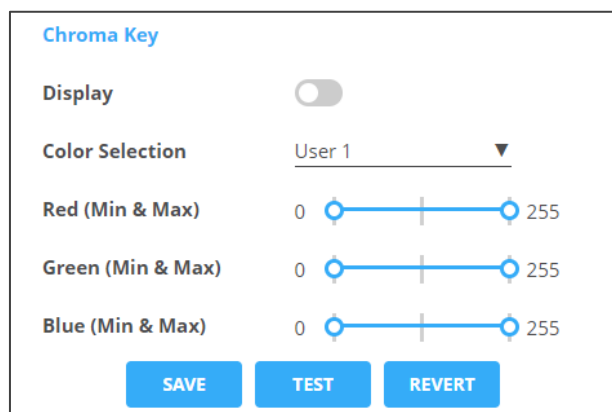

Figure 17: AV Settings Page – Matrix Mode Settings

3. Enable Chroma Key by using the Display slider.
4. Set Color Selection from the drop-down box.
If User (1 to 4) is selected, set the Red, Green and Blue manually.



If Chroma Key is enabled, Fade In & Out and Switching is disabled and vice versa.

5. Perform any of the following actions:
 - Click **TEST** to check the Chroma Key settings on the display.
 - If required, click **REVERT** to revert settings to their default values.
 - Click **SAVE** when results are satisfactory.

Chroma Key is set.

Defining the Multi-View Parameters

The Multi-View mode includes the Quad mode, PoP and PiP modes and offers 4 predefined, multi-viewer preset modes.

MV-4X enables performing the following actions:

- [Configuring Quad Operation Mode](#) on page [34](#).
- [Configuring PoP Operation Mode](#) on page [36](#).
- [Configuring PiP Operation Mode](#) on page [37](#).
- [Configuring/Recalling a Preset](#) on page [39](#).

Configuring Quad Operation Mode

In the Quad mode, 4 windows are displayed on each output. For each window select the video source and set window parameters.

To set the inputs and outputs in the Quad mode see:

- [Adjusting Input Parameters](#) on page [28](#).
- [Adjusting Output Parameters](#) on page [30](#).

To configure a Quad mode window:

1. In the Navigation List, click **AV Settings**. The Matrix tab in the AV Settings page appears (see [Figure 16](#)).
2. From the top menu bar, select **Multi View**.
3. Select the Quad mode. The Quad mode view appears and the gray indication to the right of the Multi View mode turns green.

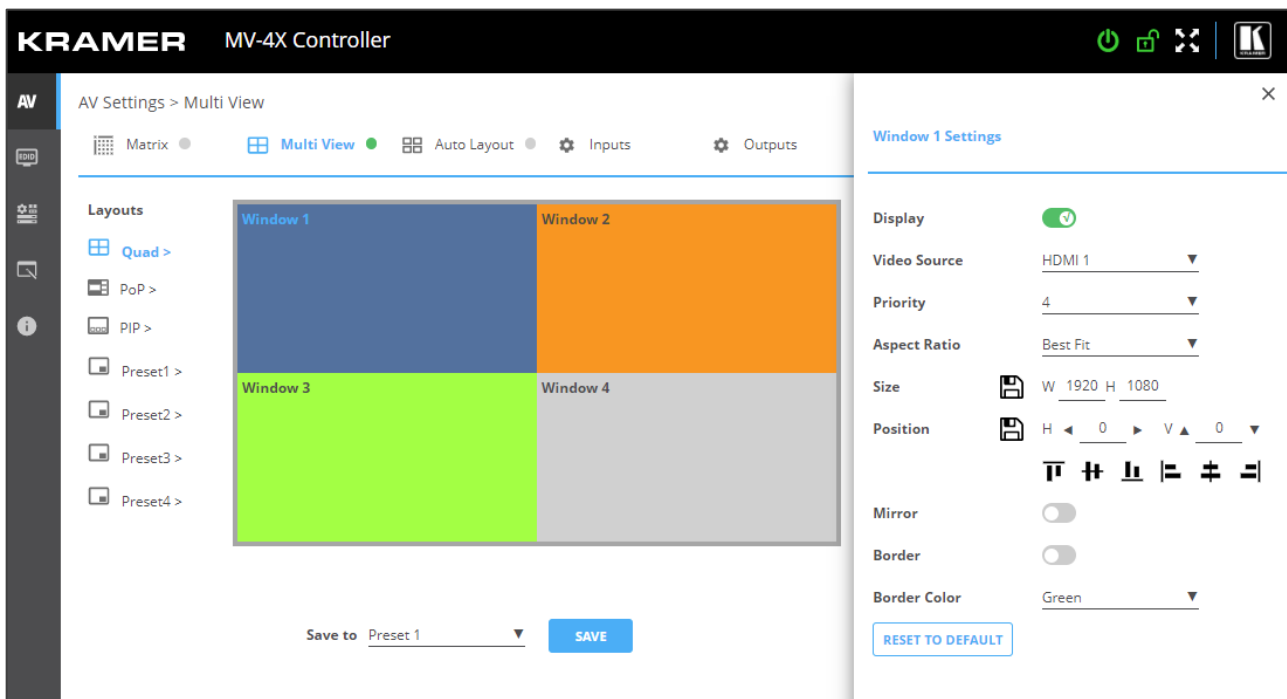

Figure 18: Multi View Tab – Quad Mode

4. For each window you can:

- Set Display slider to enable the display of the selected window.
- Select the video source.
- Set Priority (Layer) from the drop-down box (1 to 4, where 1 is the top layer).



You can set only 1 window per layer. For example, if window 1 is set to layer 4, the window that was previously set to layer 4 jumps a layer.

- Next to Size, define the size of the window and then click .
- Set the position of the window by entering its exact location (H and V), by aligning it to a display side and clicking , or by simply clicking and dragging a window.

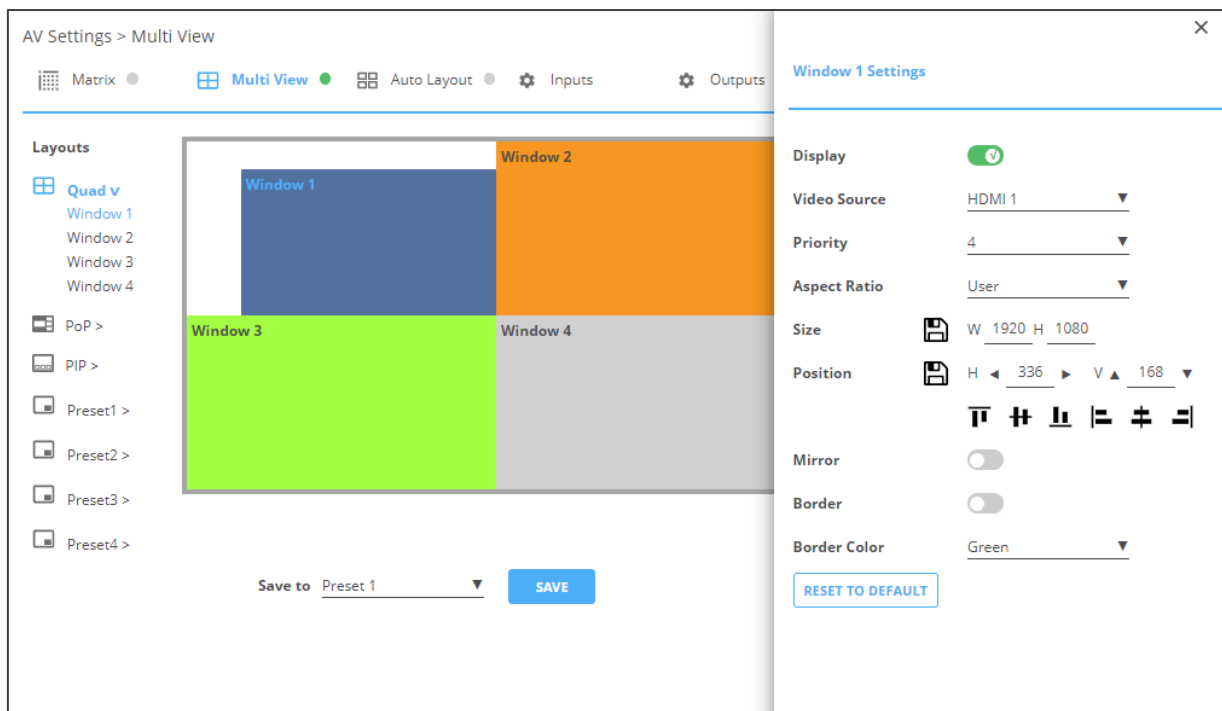

Figure 19: Quad Mode – Setting the Position of a Window

- Mirror the image horizontally using the Mirror slider.
 - Enable a border around the window using the Border slider.
 - Select the Border Color from the drop-down box.
5. If required, click **RESET TO DEFAULT** to reset the changes made to the window to their default parameters.

The window in the Quad mode is configured.

Configuring PoP Operation Mode

In the PoP mode, 4 windows are displayed on each output: one large window to the left and 3 smaller windows to the right. For each window select the video source and set window parameters.

To set the inputs and outputs in the PoP mode see:

- [Adjusting Input Parameters](#) on page [28](#).
- [Adjusting Output Parameters](#) on page [30](#).

To configure a PoP mode window:

1. In the Navigation List, click **AV Settings**. The Matrix tab in the AV Settings page appears (see [Figure 16](#)).
2. From the top menu bar, select **Multi View**.
3. Select the PoP mode. The PoP mode view appears and the gray indication to the right of the Multi View mode turns green.

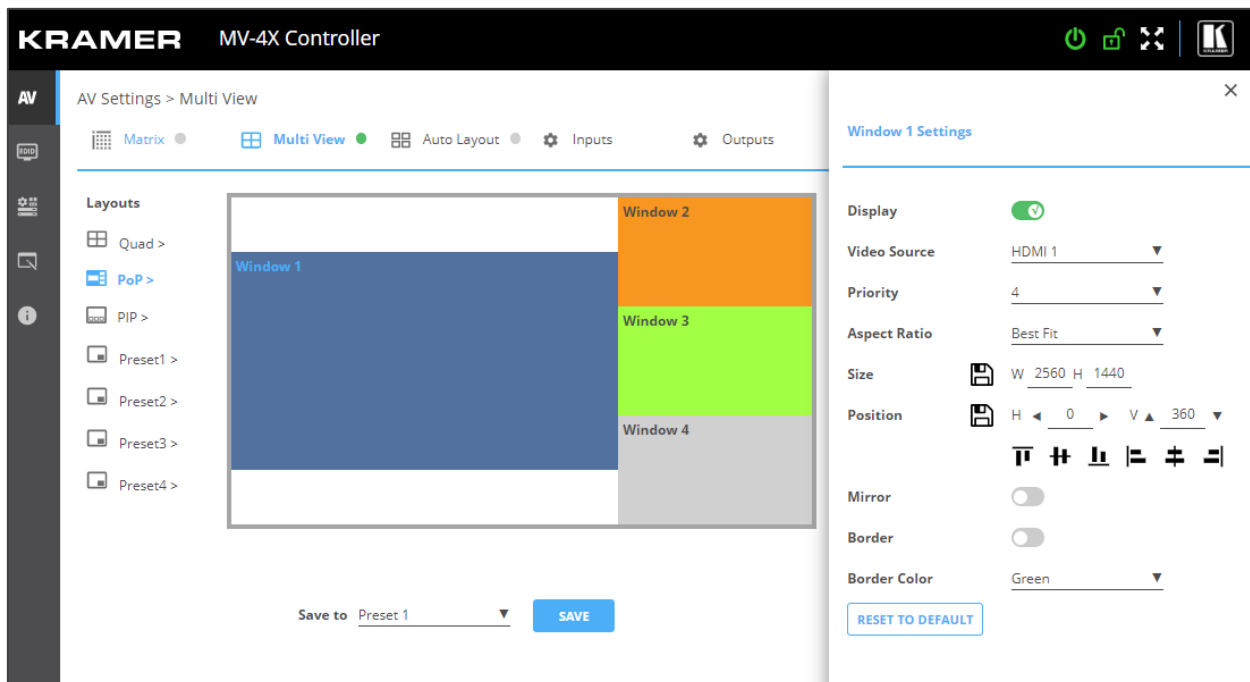



Figure 20: Multi View Tab – PoP Mode

4. For each window you can:
 - Set Display slider to enable the display of the selected window.
 - Select the video source.
 - Set Priority (Layer) from the drop-down box (1 to 4, where 1 is the top layer).
 - Next to Size, define the size of the window and then click .

- Set the position of the window by entering its exact location (H and V), by aligning it to a display side and clicking , or by simply clicking and dragging a window.

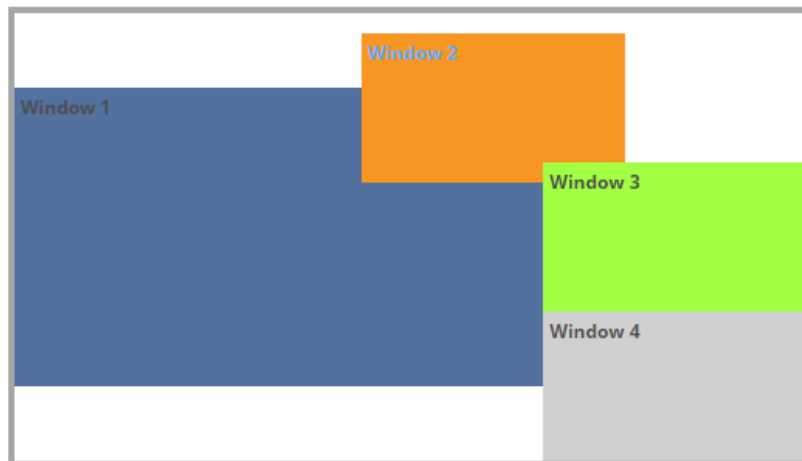

Figure 21: PoP Mode – Setting the Position of a Window

- Mirror the image horizontally using the Mirror slider.
 - Enable a border around the window using the Border slider.
 - Select the Border Color from the drop-down box.
5. If required, click **RESET TO DEFAULT** to reset the changes made to a selected window to their default parameters.

The window in the PoP mode is configured.

Configuring PiP Operation Mode

In the PiP mode, up to 4 windows are displayed on each output: one window in the background and up to 3 smaller windows to the right. For each window select the video source and set window parameters.

To set the inputs and outputs in the PiP mode see:

- [Adjusting Input Parameters](#) on page [28](#).
- [Adjusting Output Parameters](#) on page [30](#).

To configure a PiP mode window:

1. In the Navigation List, click **AV Settings**. The Matrix tab in the AV Settings page appears (see [Figure 16](#)).
2. From the top menu bar, select **Multi View**.

3. Select the PiP mode. The PiP mode view appears and the gray indication to the right of the Multi View mode turns green.

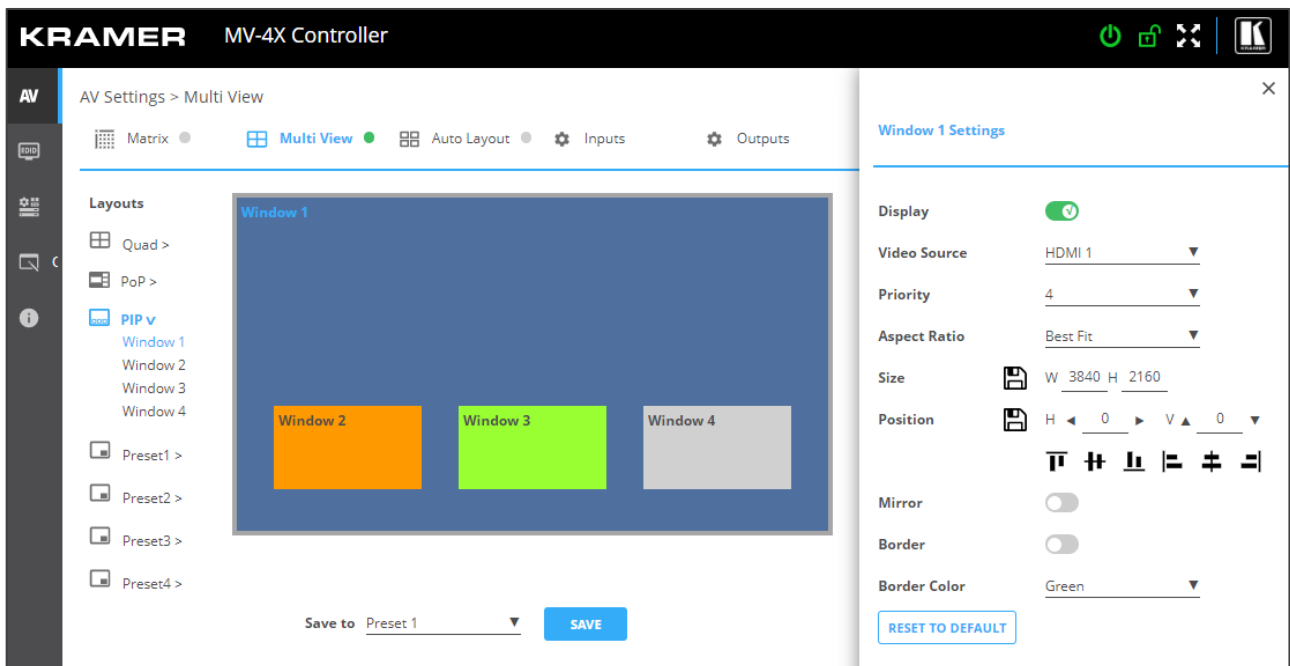

Figure 22: Multi View Tab – PiP Mode



4. For each window you can:
 - Set Display slider to enable the display of the selected window.
 - Select the video source.
 - Set Priority (Layer) from the drop-down box (1 to 4, where 1 is the top layer).
 - Next to Size, define the size of the window and then click .
 - Set the position of the window by entering its exact location (H and V), by aligning it to a display side and clicking , or by simply clicking and dragging a window.



Figure 23: PiP Mode – Setting the Position of a Window

- Mirror the image horizontally using the Mirror slider.

- Enable a border around the window using the Border slider.
 - Select the Border Color from the drop-down box.
5. If required, click **RESET TO DEFAULT** to reset the changes made to a selected window to their default parameters.

The window in the PiP mode is configured.

Configuring/Recalling a Preset

MV-4X enables storing up to 4 preset operation modes. By default, the preset is set to quad mode. For each window select the video source and set the window parameters.

In the following example, in Preset 1 the windows are configured in a stacked mode.

Presets include the window position, routing state, window source, window layer, aspect ratio, border and border color, rotation state and window state (enabled or disabled).

To set the inputs and outputs see:

- [Adjusting Input Parameters](#) on page [28](#).
- [Adjusting Output Parameters](#) on page [30](#).

To configure a preset mode window:

1. In the Navigation List, click **AV Settings**. The Matrix tab in the AV Settings page appears (see [Figure 16](#)).
2. From the top menu bar, select **Multi View**.
3. Select the Preset mode (1 to 4). The Preset mode view appears and the gray indication to the right of the Multi View mode turns green.

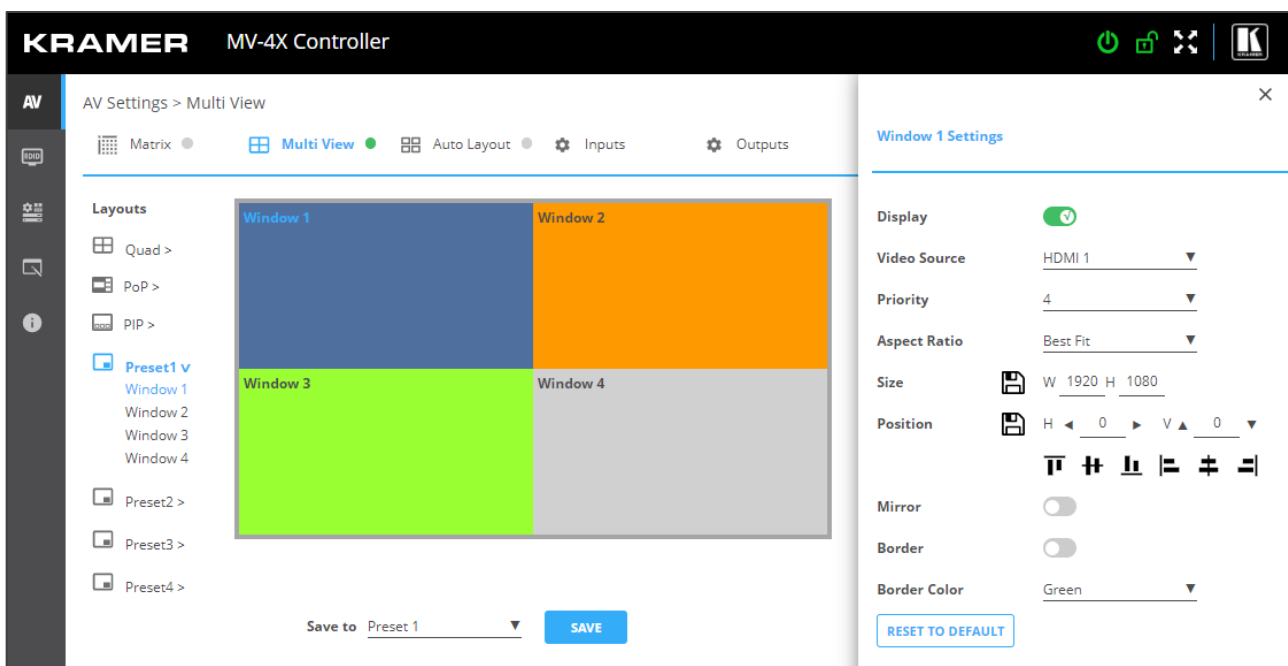



Figure 24: Multi View Tab – Preset Mode

4. For each window you can:
 - Set Display slider to enable the display of the selected window.
 - Select the video source.
 - Set Priority (Layer) from the drop-down box (1 to 4, where 1 is the top layer). in this example, Window 4 is set to Priority 1.
 - Next to Size, define the size of the window and then click .
 - Set the position of the window by entering its exact location (H and V), by aligning it to a display side and clicking , or by simply clicking and dragging a window.

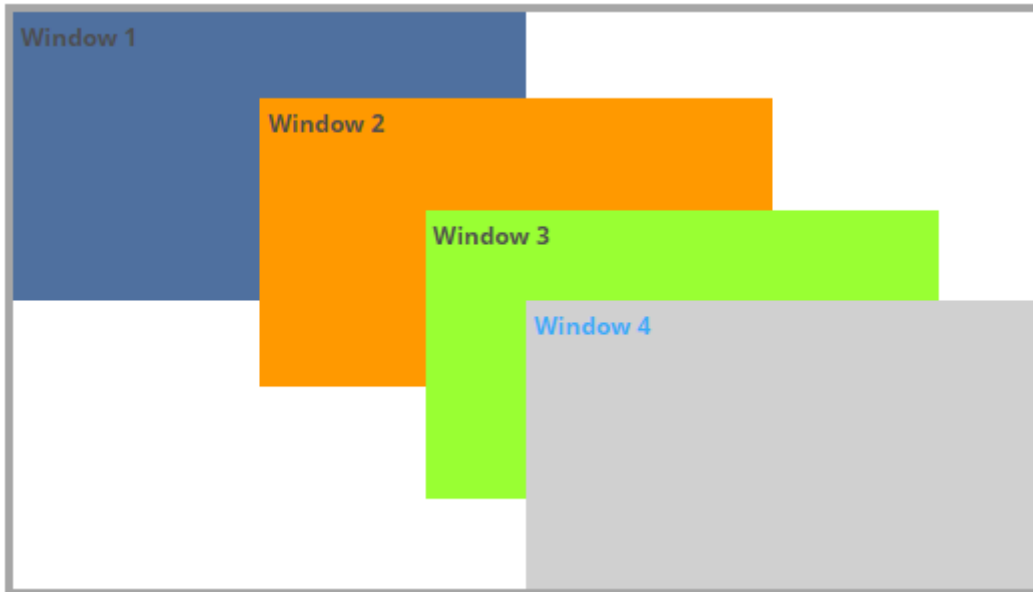

Figure 25: Preset Mode – Setting the Position of a Window (for example, Stacking the Windows)

- Mirror the image horizontally using the Mirror slider.
 - Enable a border around the window using the Border slider.
 - Select the Border Color from the drop-down box.
5. If required, click **RESET TO DEFAULT** to reset the changes made to a selected window to their default parameters.

The window in the Preset mode is configured.

Defining the Auto-Layout Parameters

In the Auto Layout operation mode, **MV-4X** automatically sets the operation mode depending on the number of currently active signals. For example, in the Auto Layout mode, if 2 active inputs are present, you can set the preferred layout for 2 inputs (Side by Side (default), PoP or PiP), if a third input is connected and active, the auto layout will then be set to Pop Side or PoP bottom (depending on your selection).

In Auto Layout, window settings are disabled.

The Auto Layout operation mode becomes active automatically and the defined layout is viewed immediately when the number of the of active sources changes.

To set the inputs and outputs mode see:

- [Adjusting Input Parameters](#) on page [28](#).
- [Adjusting Output Parameters](#) on page [30](#).

To configure the auto layout:

1. In the Navigation List, click **AV Settings**. The Matrix tab in the AV Settings page appears (see [Figure 16](#)).
2. From the top menu bar, select **Auto Layout**.
in the following example, 2 inputs are active, therefore the **Single Input** and **2 Inputs** operation modes are available.

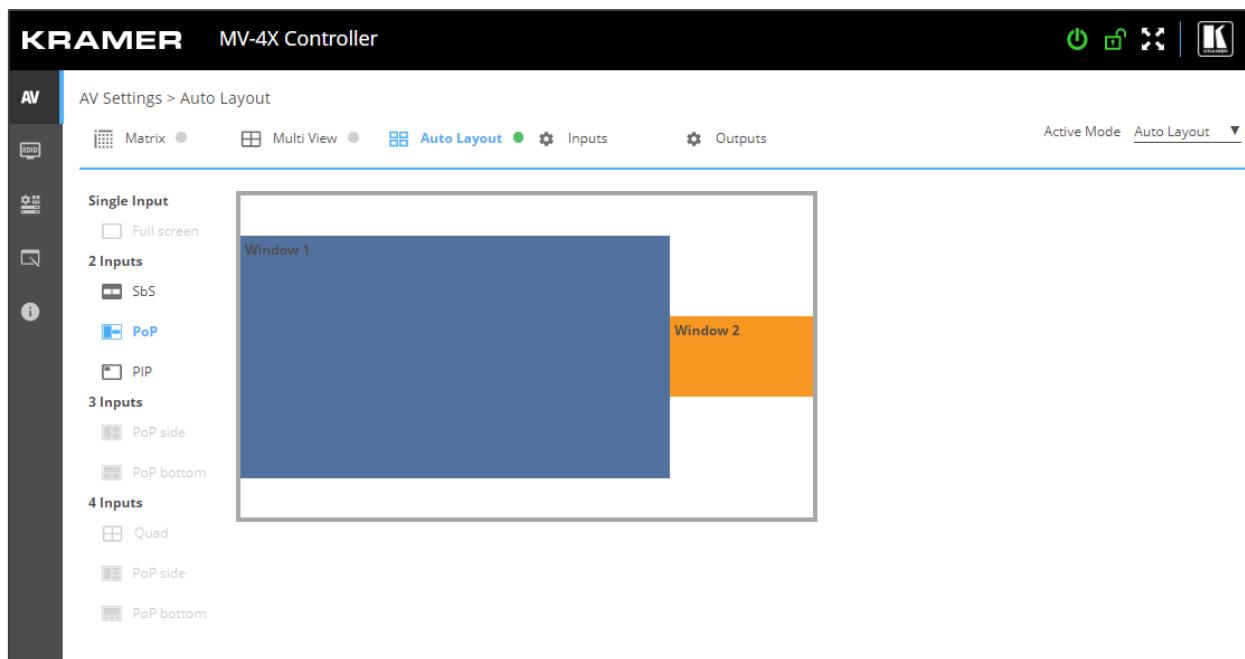

Figure 26: Multi View Tab – Auto Layout Mode

Auto Layout modes are defined.

Managing EDID

MV-4X provides the option of four default EDIDs, two sink sourced EDIDs and four user uploaded EDIDs that can be assigned to all inputs at the same time, or to each input independently.



When a new EDID is read to an input, you may view a brief blink on the output.

To manage EDID:

- 1. Click **EDID** on the Navigation List. The EDID page appears.

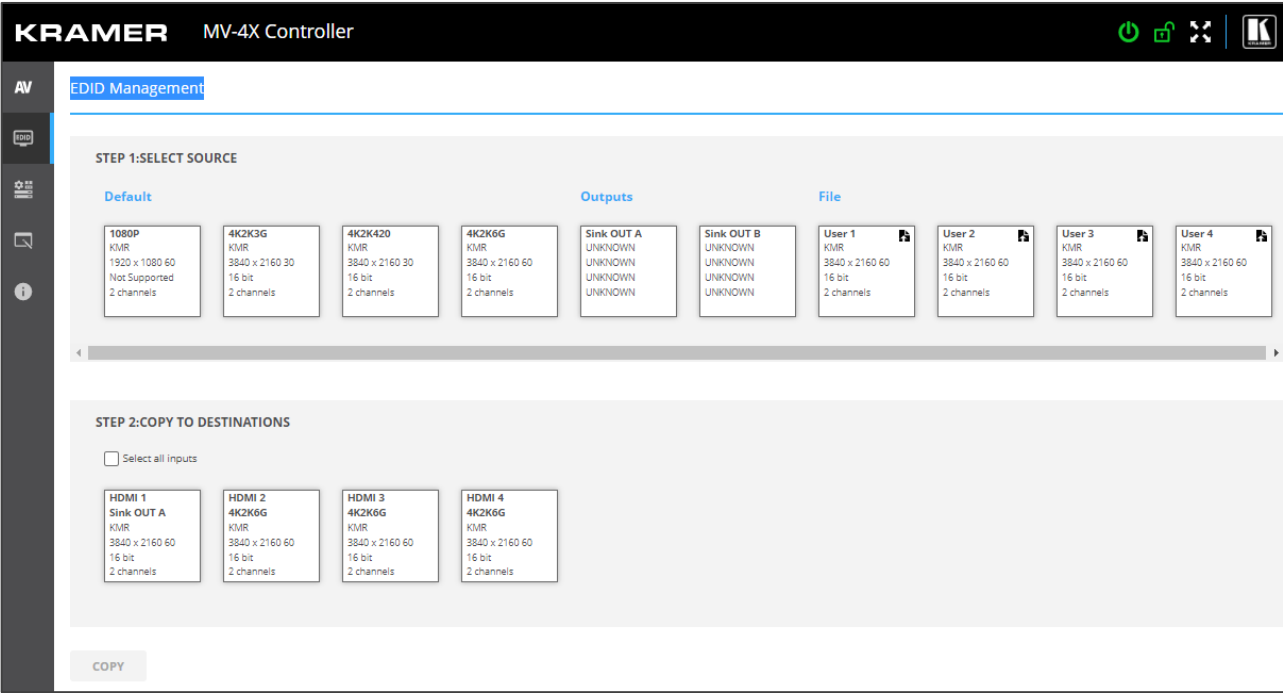

Figure 27: EDID Management Page

- 2. Under **STEP 1: SELECT SOURCE**, click the required EDID source from the default EDID options, the outputs, or select one of the User uploaded EDID configuration files (for example, the default EDID file).

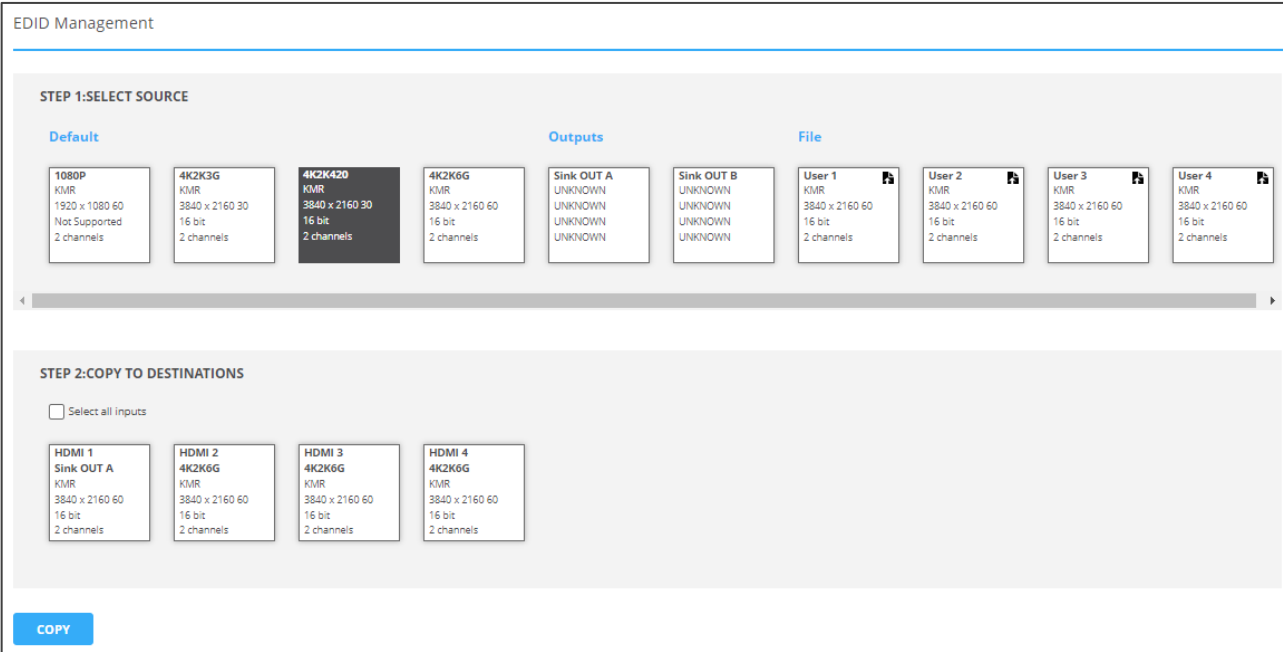

Figure 28: Selecting the EDID Source

- Under **STEP 2: SELECT DESTINATIONS**, click the input/s to copy the selected EDID to. The Copy button is enabled.

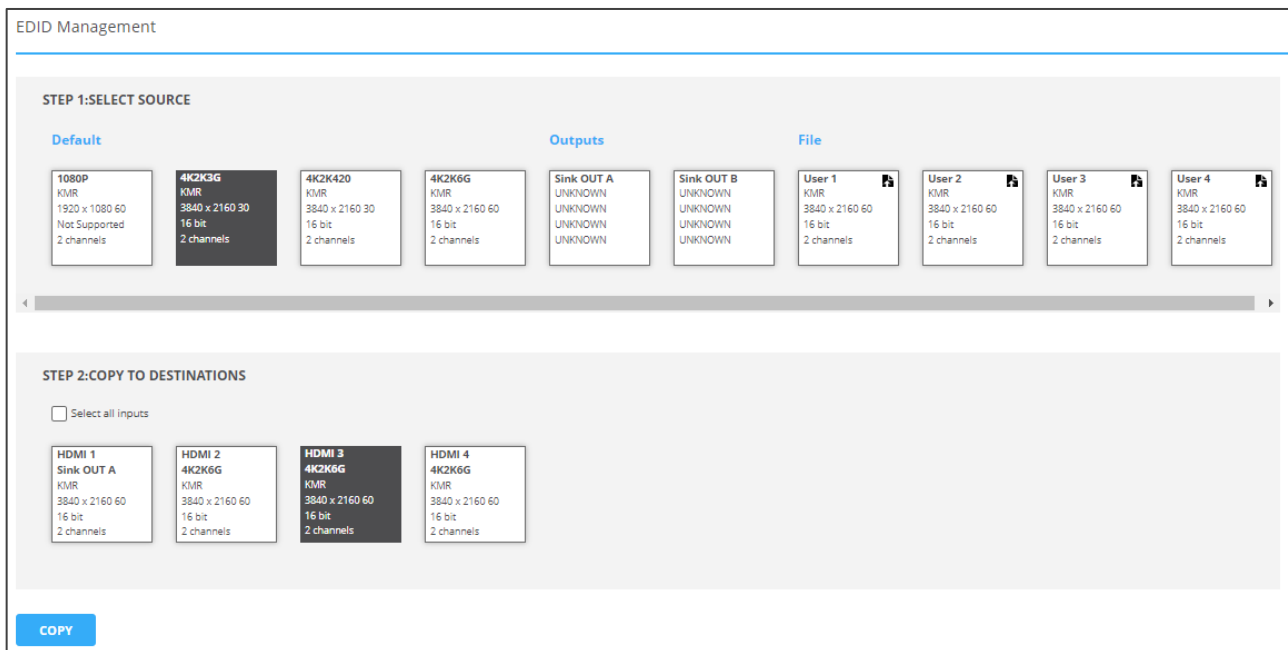

Figure 29: Selecting EDID Input Destinations

- Click **COPY**. After EDID is copied, a success message appears.

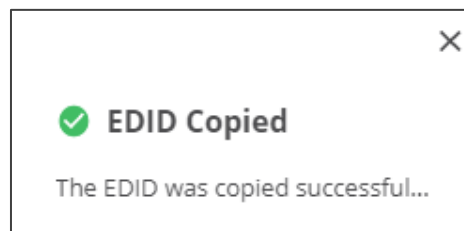



Figure 30: EDID Warning

EDID is copied to the selected input/s.

Uploading a User EDID file

User EDID files are uploaded from your PC.

To upload a User EDID:

- Click **EDID** on the Navigation List. The EDID page appears.
- Click  to open the EDID file selection window.
- Select the EDID file (*.bin file) from your PC.
- Click **Open**.

The EDID file is uploaded to the User.



In some cases, an uploaded EDID may cause compatibility issues with certain sources. If this happens, we recommended that you copy a default EDID to the input.

Defining General Settings

MV-4X enables performing the following actions via the General Settings tab:

- [Changing Device Name](#) on page 44.
- [Upgrading Firmware](#) on page 45.
- [Restarting and Resetting the Device](#) on page 45.

Changing Device Name

You can change the MV-4X name.

To change the device name:

1. In the Navigation Pane, click **Device Settings**. The General tab in the Device Settings page appears.

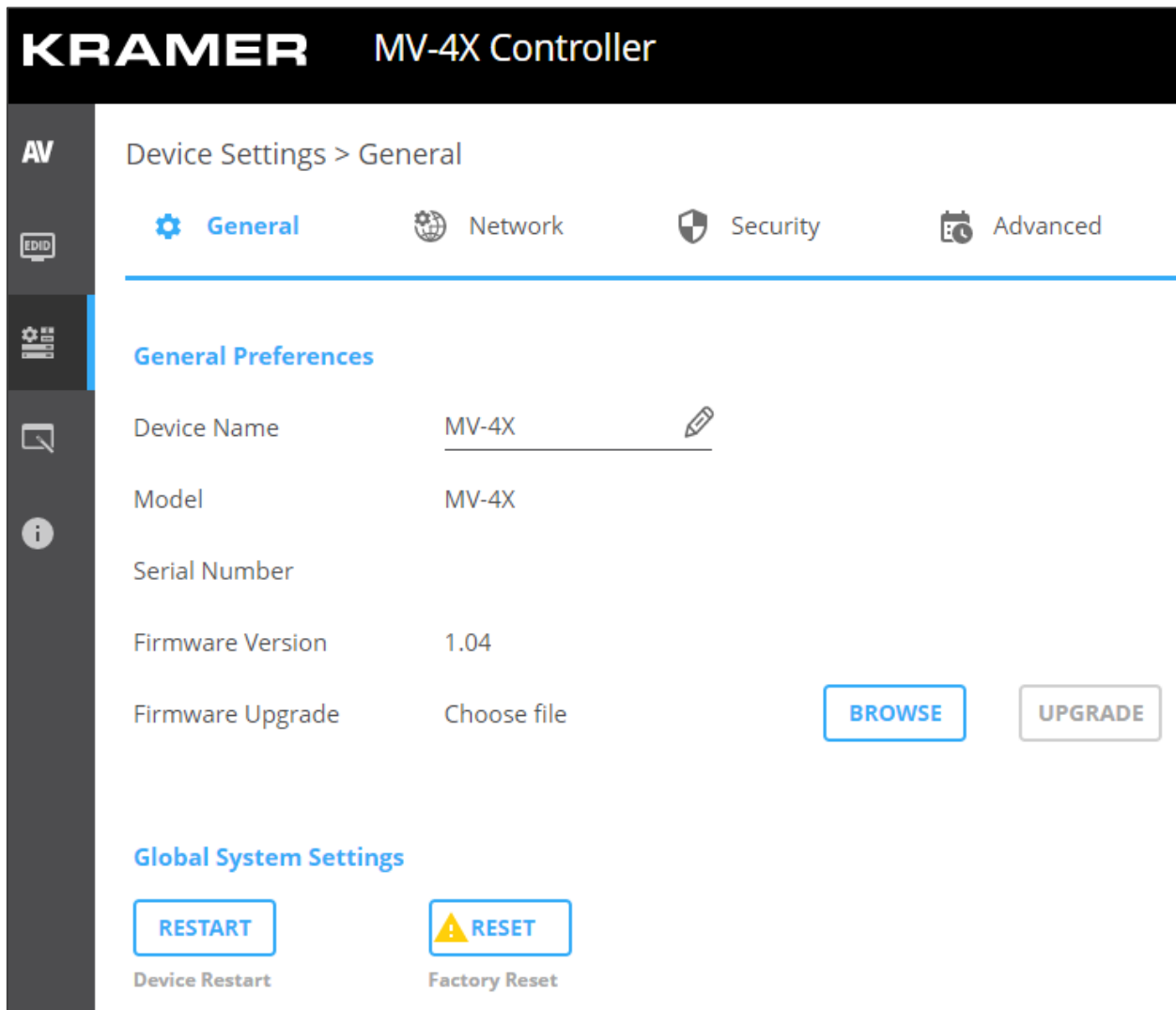

Figure 31: MV-4X Device Settings – General

2. Next to Device Name, enter the new device name (Max. 14 characters).
3. Click **SAVE**.

Device name is changed.

Upgrading Firmware

To update firmware:

1. In the navigation bar, click the **Device Settings** tab.
The Device General Settings page appears ([Figure 31](#)).
2. Click **UPGRADE**.
A file browser appears.
3. Open the relevant firmware file.
The firmware uploads to the device.

Restarting and Resetting the Device

Use the embedded web pages to restart the device and/or reset it to its default parameters.

To restart/reset the device:

1. In the navigation bar, click the **Device Settings** tab.
The Device General Settings page appears ([Figure 31](#)).
2. Click **RESTART/RESET**.

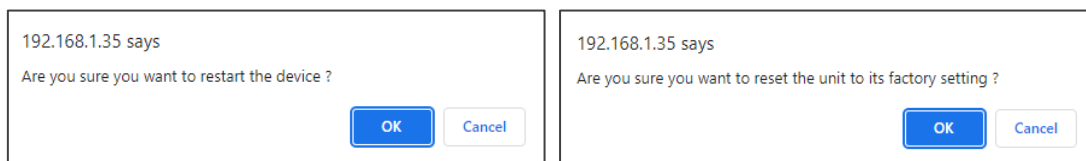

Figure 32: Restart/Reset the Device

3. Click **OK**.

The device restarts/resets.

Defining Interface Settings

Define the Ethernet port interface settings.

To define interface settings:

1. In the Navigation pane, Select **Device Settings**. The General tab in the Device Settings page appears (see [Figure 31](#)).
2. Select the **Network** tab. The Network tab appears.

The screenshot shows the Kramer MV-4X Controller web interface. The top header displays 'KRAMER MV-4X Controller'. Below the header, the navigation pane on the left includes 'AV', 'EDID', and 'Settings'. The main content area is titled 'Device Settings > Network' and features three tabs: 'General', 'Network' (selected), and 'Security'. The 'Network' tab displays the following settings:

DHCP	On Off
IP Address	192.168.1.35
Mask Address	255.255.0.0
Gateway Address	192.168.0.1
Mac Address	00-1D-56-09-5A-A4
TCP Port	5000
UDP Port	50000

At the bottom of the settings area, there are two buttons: 'SAVE' and 'CANCEL'.

Figure 33: Device Settings – Network Tab

3. Set the Media port Stream service parameters:
 - **DHCP mode** – Set DHCP to **Off** (default) or **On**.
 - **IP Address** – When DHCP mode is set to Off, the device uses a static IP address. This requires entering mask and gateway addresses.
 - **Mask Address** – Enter subnet mask.
 - **Gateway address** – Enter the gateway address.
4. Define TCP (default, 5000) and UDP (default, 50000) ports.

Interface settings are defined.

Defining MV-4X User Access

The Security tab enables activating device security and defining logon authentication details. When device security is on, web page access requires authentication upon initial landing on operation page. The default password is **admin**. By default, security is disabled.

Enabling User Access

To enable security:

1. In the Navigation pane, click **Device Settings**. The General tab in the Device Settings page appears (see [Figure 31](#)).
2. Select Security tab.

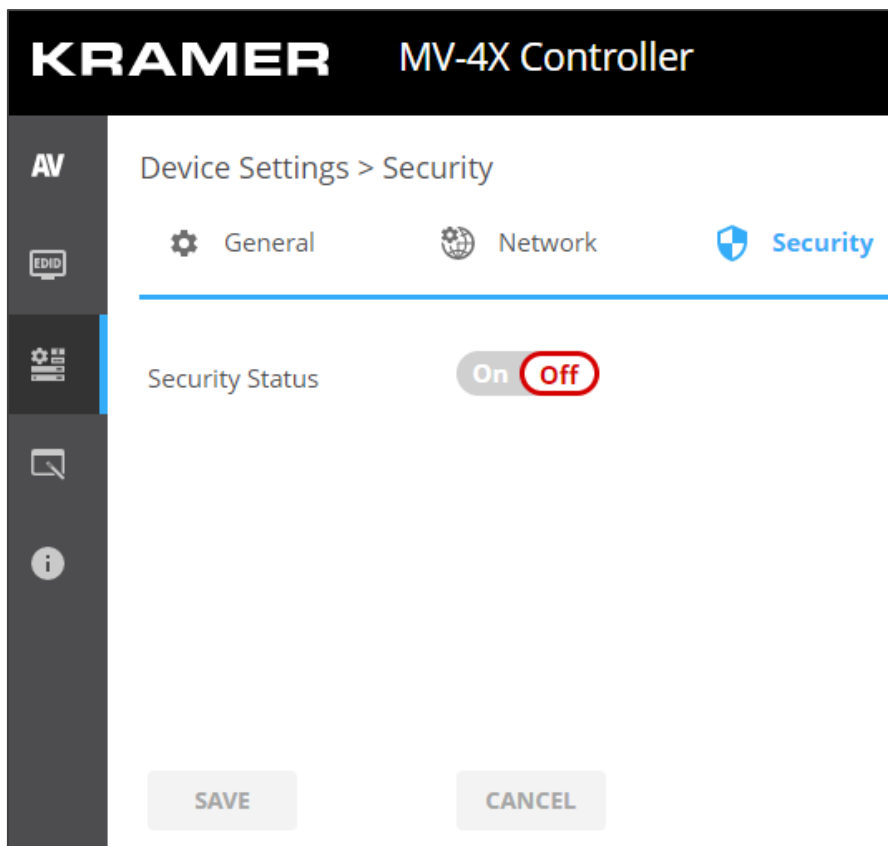

Figure 34: Device Settings – Users Tab

3. Click **On** next to Security Status to enable web page authentication (Off by default).

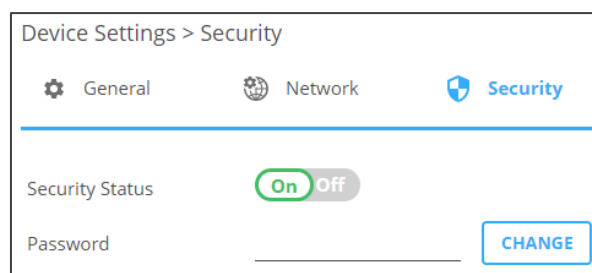

Figure 35: Security Tab – Security On

4. Click **SAVE**.

Security is enabled and access requires authentication.

Disabling User Access

To enable security:

1. In the Navigation pane, click **Device Settings**. The General tab in the Device Settings page appears (see [Figure 31](#)).
2. Select Users tab (see [Figure 34](#)).
3. Click **Off** next to Security Status to enable web page authentication.

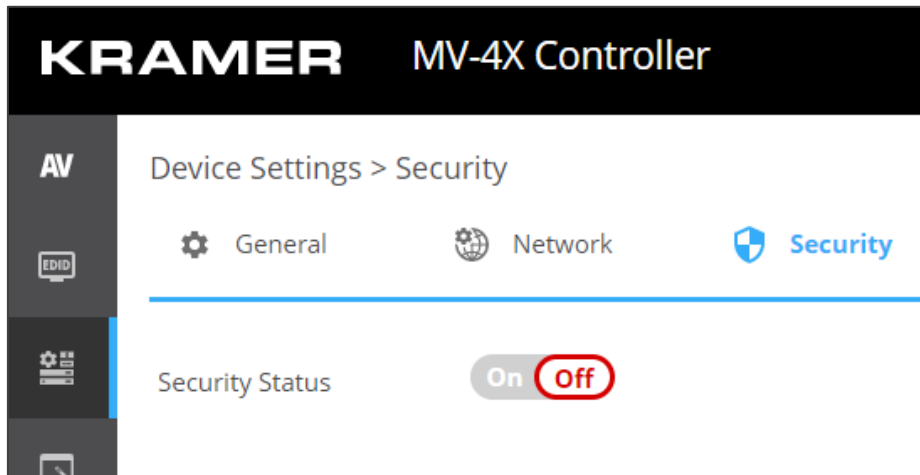

Figure 36: Device Settings – Disabling Security

Security is disabled.

Changing the Password

To change the password:

1. In the Navigation pane, click **Device Settings**. The General tab in the Device Settings page appears (see [Figure 31](#)).
2. Select Users tab (see [Figure 34](#)).
3. Next to Current Password, enter the current password.
4. Click **CHANGE**.
5. Next to New Password, enter the new password.
6. Next to Confirm Password, enter the new password again.
7. Click **SAVE**.

Password has changed.

Defining Advanced Settings

This section describes the following actions:

- [Defining Auto Sync Mode](#) on page [49](#).
- [Enabling HDR](#) on page [50](#).
- [View System Status](#) on page [50](#).

Defining Auto Sync Mode

Define auto sync off when signal is lost (also set via the OSD menu, see [Configuring the Setup](#) on page 20).

To define auto sync off:

1. In the Navigation pane, click **Advanced**. The Advanced page appears.

KRAMER MV-4X Controller

Device Settings > Advanced

General Network Security **Advanced**

Auto Sync Off Off ▼

HDR Display

System Status

Temperature 1	PASS	35	°C
Temperature 2	PASS	35	°C
Temperature 3	PASS	34	°C
Temperature 4	PASS	36	°C
Temperature 5	PASS	34	°C
Temperature 6	PASS	34	°C
Temperature 7	PASS	36	°C
Temperature 8	PASS	38	°C

Figure 37: Advanced Page

2. In the Auto Sync Off drop-down box, select the sync mode (**Off**, **Slow**, **Fast** or **Immediate**).

Auto Sync Off mode is set.

Enabling HDR

For a more detailed image and better colors on the display, you can enable HDR display.

To enable HDR display:

1. In the Navigation pane, click **Advanced**. The Advanced page appears.
2. Set HDR display to enable.

HDR is enabled.

View System Status

System Status shows the device hardware status. If hardware failure occurs or any of the parameters exceed their limits, system status indicates the problem.

To view system status:

1. In the Navigation pane, click **Advanced**. The Advanced page appears.
2. In System Status area, view temperature indicators.

System status is viewed.

Defining OSD Settings

Set the OSD display parameters such as position, transparency and so on.

To define the OSD menu:

1. In the Navigation pane, click **OSD Settings**. The General tab in the OSD Settings page appears.

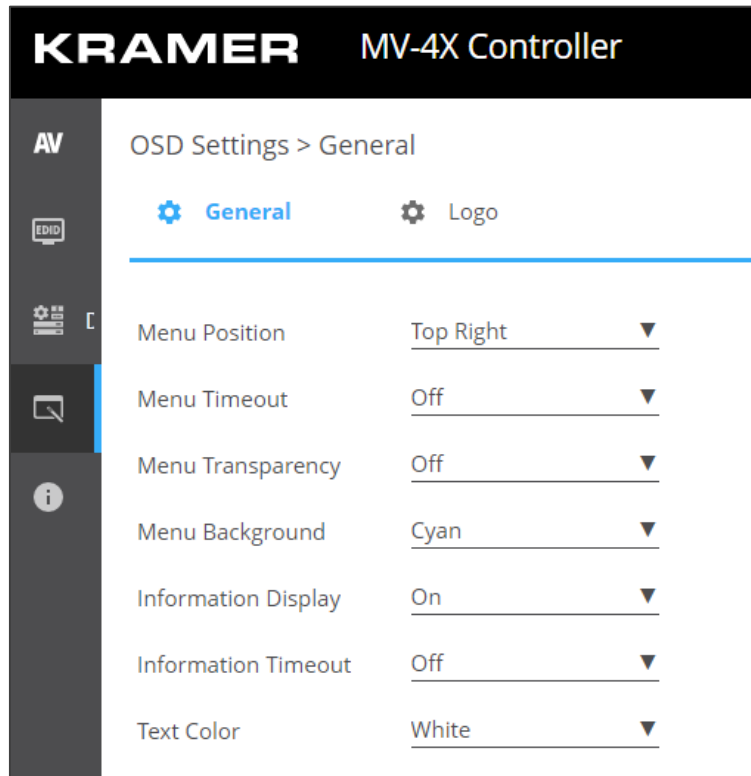

Figure 38: OSD Settings Page

2. Define the following parameters:
 - Set menu position (**Top Left**, **Top Right**, **Bottom Right** or **Bottom Left**).
 - Set menu timeout or set to Off for no timeout.
 - Set menu transparency (10 is fully transparent).
 - Select the menu background color to **Black**, **Gray** or **Cyan**.
 - Define information display status to On or off, or after a setting change (Info).
 - Select menu text color to **White**, **Magenta** or **Yellow**.

OSD menu parameters are defined.

Configuring a Logo

MV-4X enables control over the user uploaded logo graphic. Controls include positioning and uploading a new logo directly from the embedded webpages and an option to reset the logo to a built in default image that can be used for testing.

MV-4X enables the following actions:

- [Defining Logo Settings](#) on page [52](#).
- [Defining Boot Logo Settings](#) on page [53](#).

Defining Logo Settings

The OSD logo that appears in the OSD can be uploaded by the user instead of the default OSD logo.

To define OSD logo settings:

1. In the Navigation pane, click **OSD Settings**. The General tab in the OSD Settings page appears.
2. Select the Logo tab. The Logo tab appears.

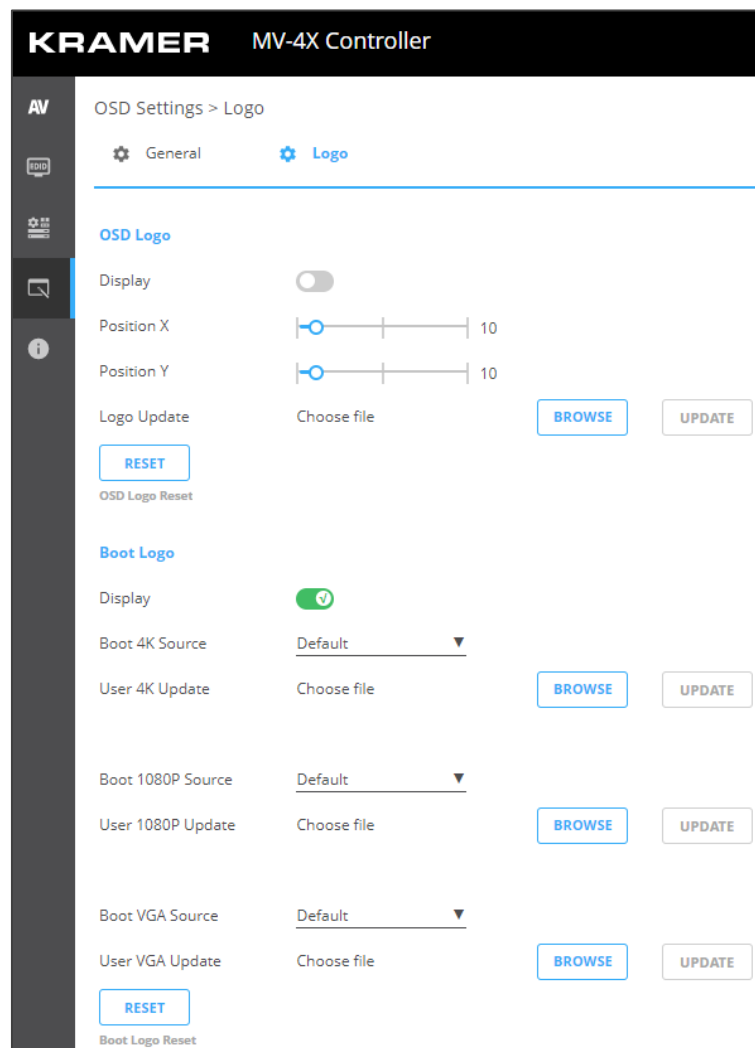

Figure 39: Configuring the Logo

3. Define the OSD Logo parameters:

- Display – Enable displaying the logo graphic or disable.
- Position X/Y – Set the horizontal and vertical upper left corner position of the logo (the value is relative to the output resolution).
- Update the Logo – Click **BROWSE** to open and select the new logo file and click **Open**. Click **UPDATE** to upload the new logo from your PC. The logo file should be 8-bit *.bmp format, 960x540 max resolution.



The upload process can take a few minutes, depending on the logo file size. The device automatically reboots when upload is complete.

- Click **RESET** to remove the current logo and upload the default test image.



This reset process can take a few minutes. The device automatically reboots when reset is complete.

OSD logo is defined.

Defining Boot Logo Settings

The boot logo that appears on the display while the device is booting up can be uploaded by the user instead of the default boot logo.

To define boot logo settings:

1. In the Navigation pane, click **OSD Settings**. The General tab in the OSD Settings page appears.
2. Select the Logo tab. The Logo tab appears.
3. Define the Boot Logo parameters:
 - Display – Enable displaying the logo graphic or disable.
 - Boot 4K Source – When the output resolution is set to 4K or above, select **Default** to display the default graphic image upon booting, or select **User** to upload a graphic.
 - User 4K Update – when User is selected, upload a 4K boot graphic, click **BROWSE** to open and select the new logo file and click **Open**. Click **UPDATE** to upload the new logo from your PC. The logo file should be 8-bit *.BMP format, 3840x2160 resolution.
 - Boot 1080P Source – When the output resolution is set between 1080P and VGA, select **Default** to display the default graphic image upon booting, or select **User** to upload a graphic.
 - User 1080P Update – when User is selected, upload a 1080P boot graphic, click **BROWSE** to open and select the new logo file and click **Open**. Click **UPDATE** to upload the new logo from your PC. The logo file should be 8-bit *.BMP format, 1920x1080 resolution.
 - Boot VGA Source – When the output resolution is set to VGA or less, select **Default** to display the default the default graphic image upon booting, or select **User** to upload a graphic.

- User VGA Update – when User is selected, upload a VGA boot graphic, click **BROWSE** to open and select the new logo file and click **Open**. Click **UPDATE** to upload the new logo from your PC. The logo file should be 8-bit *.BMP format, 640×480 resolution.
- Click RESET to remove the current boot logo.

Boot logos are defined.

Viewing the About Page

View the firmware version and Kramer Electronics Ltd details in the About page.

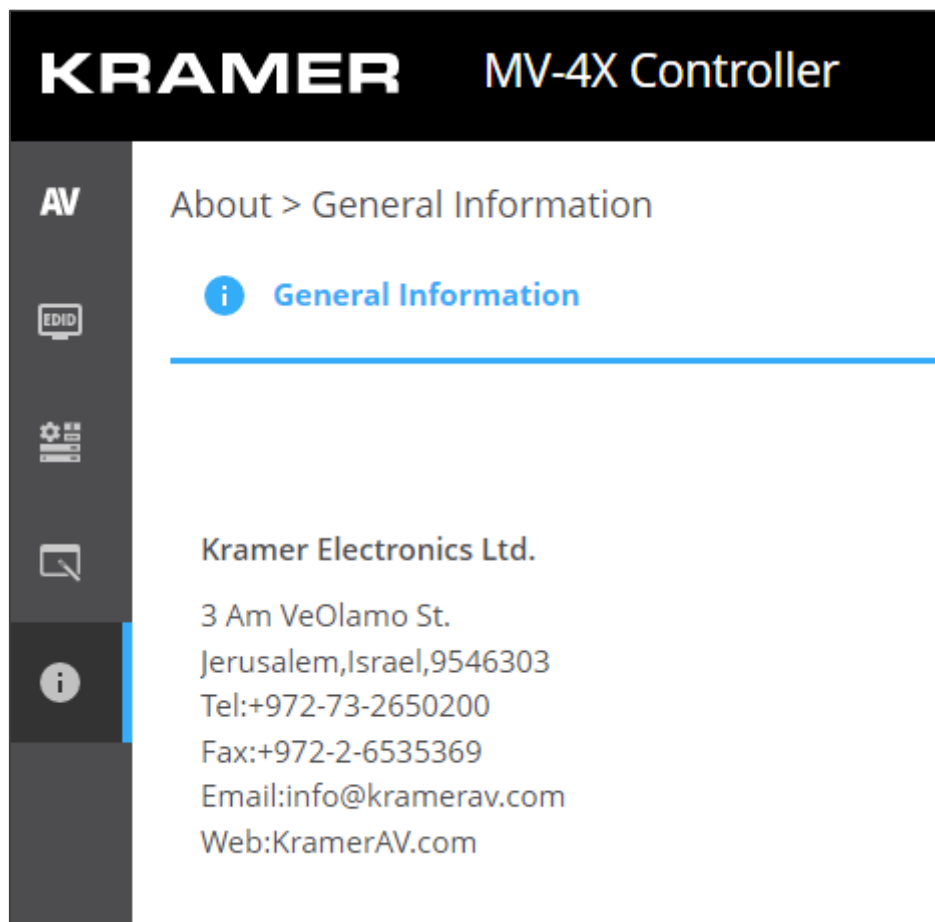

Figure 40: About Page

Technical Specifications

Inputs	4 HDMI	On a female HDMI connector
Outputs	1 HDMI	On a female HDMI connector
	1 HDBT	On an RJ-45 connector
	1 Balanced Stereo Audio	On a 5-pin terminal block
Ports	1 IR IN	On an RCA connector for IR tunneling
	1 IR OUT	On an RCA connector for IR tunneling
	1 RS-232	On a 3-pin terminal block for RS-232 tunneling
	1 RS-232	On a 3-pin terminal block for device control
	Ethernet	On an RJ-45 port
	1 USB	On a type A USB port
Video	Max Bandwidth	18Gbps (6Gbps per graphic channel)
	Max Resolution	HDM: 14K@60Hz (4:4:4) HDBaseT: 4K60 4:2:0
	Compliance	HDMI 2.0 and HDCP 2.3
Controls	Front Panel	Input, output and window buttons, operation mode buttons, menu buttons, resolution reset and panel lock buttons
Indication LEDs	Front Panel	Output and window indication LEDs
Analog Audio	Max Vrms Level	15dBu
	Impedance	500Ω
	Frequency Response	20Hz - 20kHz @ +/-0.3dB
	S/N Ratio	>-88dB, 20Hz - 20kHz, at unity gain (unweighted)
	THD + Noise	<0.003%, 20 Hz - 20 kHz, at unity gain
Power	Consumption	12V DC, 1.9A
	Source	12V DC, 5A
Environmental Conditions	Operating Temperature	0° to +40°C (32° to 104°F)
	Storage Temperature	-40° to +70°C (-40° to 158°F)
	Humidity	10% to 90%, RHL non-condensing
Regulatory Compliance	Safety	CE, FCC
	Environmental	RoHs, WEEE
Enclosure	Size	Half 19" 1U
	Type	Aluminum
	Cooling	Convection Ventilation
General	Net Dimensions (W, D, H)	21.3cm x 23.4cm x 4cm (8.4" x 9.2" x 1.6")
	Shipping Dimensions (W, D, H)	39.4cm x 29.6cm x 9.1cm (15.5" x 11.6" x 3.6")
	Net Weight	1.29kg (2.8lbs)
	Shipping Weight	1.84kg (4lbs) approx.
Accessories	Included	Power cord and adapter
Specifications are subject to change without notice at www.kramerav.com		

Default Communication Parameters

RS-232	
Baud Rate:	115,200
Data Bits:	8
Stop Bits:	1
Parity:	None
Command Format:	ASCII
Example (rotate window 1 by 180 degrees):	#ROTATE_1,1,3<CR>
Ethernet	
To reset the IP settings to the factory reset values go to: Menu->Setup -> Factory Reset-> press Enter to confirm	
IP Address:	192.168.1.39
Subnet mask:	255.255.255.0
Default gateway:	192.168.1.254
TCP Port #:	5000
UDP Port #:	50000
Default username:	admin
Default password:	admin
Full Factory Reset	
OSD	Go to: Menu-> Setup -> Factory Reset -> press Enter to confirm
Front panel buttons	

Default EDID

Monitor

Model name..... MV-4X
 Manufacturer..... KMR
 Plug and Play ID..... KMR060D
 Serial number..... 49
 Manufacture date..... 2018, ISO week 6
 Filter driver..... None

EDID revision..... 1.3
 Input signal type..... Digital
 Color bit depth..... Undefined
 Display type..... Monochrome/grayscale
 Screen size..... 310 x 170 mm (13.9 in)
 Power management..... Standby, Suspend
 Extension blocs..... 1 (CEA/CTA-EXT)

DDC/CI..... Not supported

Color characteristics

Default color space..... Non-sRGB
 Display gamma..... 2.40
 Red chromaticity..... Rx 0.611 - Ry 0.329
 Green chromaticity..... Gx 0.313 - Gy 0.559
 Blue chromaticity..... Bx 0.148 - By 0.131
 White point (default)... Wx 0.320 - Wy 0.336
 Additional descriptors... None

Timing characteristics

Horizontal scan range.... 15-136kHz
 Vertical scan range..... 23-61Hz
 Video bandwidth..... 600MHz
 CVT standard..... Not supported
 GTF standard..... Not supported
 Additional descriptors... None
 Preferred timing..... Yes
 Native/preferred timing.. 3840x2160p at 60Hz (16:9)
 Modeline..... "3840x2160" 594.000 3840 4016 4104 4400 2160 2168 2178 2250 +hsync +vsync
 Detailed timing #1..... 1920x1080p at 60Hz (16:9)
 Modeline..... "1920x1080" 148.500 1920 2008 2052 2200 1080 1084 1089 1125 +hsync +vsync

Standard timings supported

640 x 480p at 60Hz - IBM VGA
 640 x 480p at 72Hz - VESA
 640 x 480p at 75Hz - VESA
 800 x 600p at 56Hz - VESA
 800 x 600p at 60Hz - VESA
 800 x 600p at 72Hz - VESA
 800 x 600p at 75Hz - VESA
 1024 x 768p at 60Hz - VESA
 1024 x 768p at 70Hz - VESA
 1024 x 768p at 75Hz - VESA
 1280 x 1024p at 75Hz - VESA
 1600 x 1200p at 60Hz - VESA STD
 1280 x 1024p at 60Hz - VESA STD
 1400 x 1050p at 60Hz - VESA STD
 1920 x 1080p at 60Hz - VESA STD
 640 x 480p at 85Hz - VESA STD
 800 x 600p at 85Hz - VESA STD
 1024 x 768p at 85Hz - VESA STD
 1280 x 1024p at 85Hz - VESA STD

EIA/CEA/CTA-861 Information

Revision number..... 3
 IT underscan..... Supported
 Basic audio..... Supported
 YCbCr 4:4:4..... Supported
 YCbCr 4:2:2..... Supported
 Native formats..... 0
 Detailed timing #1..... 1440x900p at 60Hz (16:10)
 Modeline..... "1440x900" 106.500 1440 1520 1672 1904 900 903 909 934 -hsync +vsync
 Detailed timing #2..... 1366x768p at 60Hz (16:9)
 Modeline..... "1366x768" 85.500 1366 1436 1579 1792 768 771 774 798 +hsync +vsync
 Detailed timing #3..... 1920x1200p at 60Hz (16:10)
 Modeline..... "1920x1200" 154.000 1920 1968 2000 2080 1200 1203 1209 1235 +hsync -vsync

CE video identifiers (VICs) - timing/formats supported

1920 x 1080p at 60Hz - HDTV (16:9, 1:1)
 1920 x 1080p at 50Hz - HDTV (16:9, 1:1)
 1280 x 720p at 60Hz - HDTV (16:9, 1:1)
 1280 x 720p at 50Hz - HDTV (16:9, 1:1)
 1920 x 1080i at 60Hz - HDTV (16:9, 1:1)
 1920 x 1080i at 50Hz - HDTV (16:9, 1:1)
 720 x 480p at 60Hz - EDTV (4:3, 8:9)
 720 x 576p at 50Hz - EDTV (4:3, 16:15)
 720 x 480i at 60Hz - Doublescan (4:3, 8:9)
 720 x 576i at 50Hz - Doublescan (4:3, 16:15)
 1920 x 1080p at 30Hz - HDTV (16:9, 1:1)
 1920 x 1080p at 25Hz - HDTV (16:9, 1:1)
 1920 x 1080p at 24Hz - HDTV (16:9, 1:1)
 1920 x 1080p at 24Hz - HDTV (16:9, 1:1)
 1920 x 1080p at 24Hz - HDTV (16:9, 1:1)
 1920 x 1080p at 24Hz - HDTV (16:9, 1:1)
 1920 x 1080p at 24Hz - HDTV (16:9, 1:1)
 1920 x 1080p at 24Hz - HDTV (16:9, 1:1)
 NB: NTSC refresh rate = (Hz*1000)/1001

CE audio data (formats supported)

LPCM 2-channel, 16/20/24 bit depths at 32/44/48 kHz

CE speaker allocation data

Channel configuration.... 2.0
 Front left/right..... Yes
 Front LFE..... No
 Front center..... No
 Rear left/right..... No
 Rear center..... No
 Front left/right center.. No
 Rear left/right center... No
 Rear LFE..... No

CE vendor specific data (VSDB)

IEEE registration number. 0x000C03
 CEC physical address.... 1.0.0.0
 Supports AI (ACP, ISRC).. No
 Supports 48bpp..... Yes
 Supports 36bpp..... Yes
 Supports 30bpp..... Yes
 Supports YCbCr 4:4:4.... Yes
 Supports dual-link DVI... No
 Maximum TMDS clock..... 300MHz
 Audio/video latency (p).. n/a
 Audio/video latency (i).. n/a

HDMI video capabilities.. Yes
EDID screen size..... No additional info
3D formats supported..... Not supported
Data payload..... 030C001000783C20008001020304

CE vendor specific data (VSDB)
IEEE registration number. 0xC45DD8
CEC physical address..... 0.1.7.8
Supports AI (ACP, ISRC).. Yes
Supports 48bpp..... No
Supports 36bpp..... No
Supports 30bpp..... No
Supports YCbCr 4:4:4..... No
Supports dual-link DVI... No
Maximum TMDS clock..... 35MHz

YCbCr 4:2:0 capability map data
Data payload..... 0F000003

Report information
Date generated..... 16/06/2022
Software revision..... 2.91.0.1043
Data source..... Real-time 0x0041
Operating system..... 10.0.19042.2

Raw data
00,FF,FF,FF,FF,FF,FF,00,2D,B2,0D,06,31,00,00,00,06,1C,01,03,80,1F,11,8C,C2,90,20,9C,54,50,8F,26,
21,52,56,2F,CF,00,A9,40,81,80,90,40,D1,C0,31,59,45,59,61,59,81,99,08,E8,00,30,F2,70,5A,80,B0,58,
8A,00,BA,88,21,00,00,1E,02,3A,80,18,71,38,2D,40,58,2C,45,00,BA,88,21,00,00,1E,00,00,00,FC,00,4D,
56,2D,34,58,0A,20,20,20,20,20,20,00,00,00,FD,00,17,3D,0F,88,3C,00,0A,20,20,20,20,20,01,38,
02,03,3B,F0,52,10,1F,04,13,05,14,02,11,06,15,22,21,20,5D,5E,5F,60,61,23,09,07,07,83,01,00,00,6E,
03,0C,00,10,00,78,3C,20,00,80,01,02,03,04,67,D8,5D,C4,01,78,80,07,E4,0F,00,00,03,9A,29,A0,D0,51,
84,22,30,50,98,36,00,10,0A,00,00,00,1C,66,21,56,AA,51,00,1E,30,46,8F,33,00,10,09,00,00,00,1E,28,
3C,80,A0,70,B0,23,40,30,20,36,00,10,0A,00,00,00,1A,00,00,00,00,00,00,00,00,00,00,00,00,00,00,E0

Protocol 3000

Kramer devices can be operated using Kramer Protocol 3000 commands sent via serial or Ethernet ports.

Understanding Protocol 3000

Protocol 3000 commands are a sequence of ASCII letters, structured according to the following.

- **Command format:**

Prefix	Command Name	Constant (Space)	Parameter(s)	Suffix
#	Command	_	Parameter	<CR>

- **Feedback format:**

Prefix	Device ID	Constant	Command Name	Parameter(s)	Suffix
~	nn	@	Command	Parameter	<CR><LF>

- **Command parameters** – Multiple parameters must be separated by a comma (,). In addition, multiple parameters can be grouped as a single parameter using brackets ([and]).
- **Command chain separator character** – Multiple commands can be chained in the same string. Each command is delimited by a pipe character (|).
- **Parameters attributes** – Parameters may contain multiple attributes. Attributes are indicated with pointy brackets (<...>) and must be separated by a period (.).

The command framing varies according to how you interface with MV-4X. The following figure displays how the # command is framed using terminal communication software (such as Hercules):

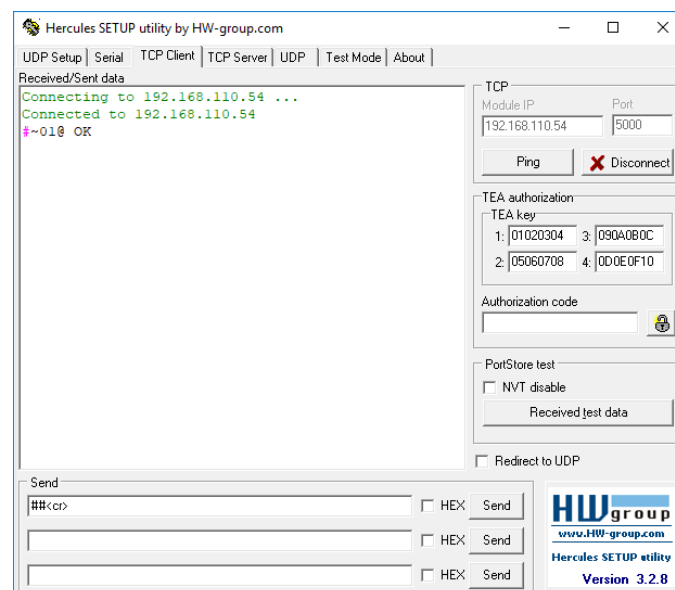

Protocol 3000 Commands

Function	Description	Syntax	Parameters/Attributes	Example
#	<p>Protocol handshaking.</p> <p>① Validates the Protocol 3000 connection and gets the machine number.</p> <p>Step-in master products use this command to identify the availability of a device.</p>	<p>COMMAND</p> <pre>#<CR></pre> <p>FEEDBACK</p> <pre>~nn@_ok<CR><LF></pre>		#<CR>
AUD-LVL	Set audio output level and mute/unmute status.	<p>COMMAND</p> <pre>#AUD-LVL_io_mode,out_id,value,status<CR></pre> <p>FEEDBACK</p> <pre>~nn@AUD-LVL_io_mode,out_id,value,status<CR><LF></pre>	<p>io_mode –</p> <p>1– Output</p> <p>out_id –</p> <p>1– HDMI Out A</p> <p>2– HDBT Out B</p> <p>value –value 0 to 100.</p> <p>status –</p> <p>0– Unmute</p> <p>1– Mute</p>	Set audio HDBT output level to 3 and unmute: #AUD-LVL_1,1,3,0<CR>
AUD-LVL?	Get latest selected audio output level and mute/unmute status.	<p>COMMAND</p> <pre>#AUD-LVL?_io_mode<CR></pre> <p>FEEDBACK</p> <pre>~nn@#AUD-LVL_io_mode,out_id,value,status<CR><LF></pre>	<p>io_mode –</p> <p>1– Output</p> <p>out_id –</p> <p>1– HDMI Out A</p> <p>2– HDBT Out B</p> <p>value –value 0 to 100.</p> <p>status –</p> <p>0– Unmute</p> <p>1– Mute</p>	Get rotation state of IN 3: #AUD-LVL?_1<CR>
BRIGHTNESS	<p>Set image brightness per window.</p> <p>① Value limits can vary for different devices.</p>	<p>COMMAND</p> <pre>#BRIGHTNESS_win_num,value<CR></pre> <p>FEEDBACK</p> <pre>~nn@BRIGHTNESS_win_num,value<CR><LF></pre>	<p>win_num – Number that indicates the specific window: 1-4</p> <p>value – Brightness value 0 to 100.</p>	Set brightness for window 1 to 50: #BRIGHTNESS_1,50<CR>
BRIGHTNESS?	<p>Get image brightness per output.</p> <p>① Value limits can vary for different devices.</p>	<p>COMMAND</p> <pre>#BRIGHTNESS?_win_num<CR></pre> <p>FEEDBACK</p> <pre>~nn@BRIGHTNESS_win_num,value<CR><LF></pre>	<p>win_num – Number that indicates the specific window: 1-4</p> <p>value – Brightness value 0 to 100.</p>	Get brightness for window 1: #BRIGHTNESS?_1<CR>
BUILD-DATE?	Get device build date.	<p>COMMAND</p> <pre>#BUILD-DATE?_<CR></pre> <p>FEEDBACK</p> <pre>~nn@BUILD-DATE_date,time<CR><LF></pre>	<p>date – Format: YYYY/MM/DD where</p> <p>YYYY = Year</p> <p>MM = Month</p> <p>DD = Day</p> <p>time – Format: hh:mm:ss where</p> <p>hh = hours</p> <p>mm = minutes</p> <p>ss = seconds</p>	Get the device build date: #BUILD-DATE?<CR>
CONTRAST	<p>Set image contrast per output.</p> <p>① Value limits can vary for different devices.</p>	<p>COMMAND</p> <pre>#CONTRAST_win_num,value<CR></pre> <p>FEEDBACK</p> <pre>~nn@CONTRAST_win_num,value<CR><LF></pre>	<p>win_num – Number that indicates the specific window: 1-4</p> <p>value – Contrast value 0 to 100.</p>	Set contrast for window 1 to 40: #CONTRAST_1,40<CR>
CONTRAST?	<p>Get image contrast per output.</p> <p>① Value limits can vary for different devices.</p> <p>Value is a property of input connected to current window. Changing the window input source might cause changes in this value (refer to device definitions).</p> <p>In devices that enable showing multiple outputs on one display – each in a separate window – this command relates only to the window associated with the output indicated in the out-index parameter.</p>	<p>COMMAND</p> <pre>#CONTRAST?_win_num<CR></pre> <p>FEEDBACK</p> <pre>~nn@CONTRAST_win_num,value<CR><LF></pre>	<p>win_num – Number that indicates the specific window: 1-4</p> <p>value – Contrast value 0 to 100.</p>	Get contrast for window 1: #CONTRAST?_1<CR>

Function	Description	Syntax	Parameters/Attributes	Example
CPEDID	<p>Copy EDID data from the output to the input EEPROM.</p> <p>i Destination bitmap size depends on device properties (for 64 inputs it is a 64-bit word).</p> <p>Example: bitmap 0x0013 means inputs 1,2 and 5 are loaded with the new EDID.</p> <p>In certain products Safe_mode is an optional parameter. See the HELP command for its availability.</p>	<p>COMMAND</p> <pre>#CPEDID_edid_io,src_id,edid_io,dest_bitmap<CR></pre> <p>or</p> <pre>#CPEDID_edid_io,src_id,edid_io,dest_bitmap,safe_mode<CR></pre> <p>FEEDBACK</p> <pre>~nn@CPEDID_edid_io,src_id,edid_io,dest_bitmap,<CR><LF></pre> <pre>~nn@CPEDID_edid_io,src_id,edid_io,dest_bitmap,safe_mode<CR><LF></pre>	<p>edid_io – EDID source type (usually output)</p> <p>1 – Output</p> <p>src_id – Number of chosen source stage</p> <p>1 – Default 1 2 – Default 2 3 – Default 3 4 – Default 4 5 – HDMI OUT 6 – HDBT OUT 7 – User 1 8 – User 2 9 – User 3 10 – User 4</p> <p>edid_io – EDID destination type (usually input)</p> <p>0 – Input</p> <p>dest_bitmap – Bitmap representing destination IDs. Format: XXXX...X, where X is hex digit. The binary form of every hex digit represents corresponding destinations.</p> <p>0x01:HDMI1 0x02:HDMI2 0x04:HDMI3 0x08:HDMI4</p> <p>safe_mode – Safe mode</p> <p>0 – device accepts the EDID as is without trying to adjust 1 – device tries to adjust the EDID (default value if no parameter is sent)</p>	<p>Copy the EDID data from the HDMI OUT (EDID source) to Input 1:</p> <pre>#CPEDID_1,5,0,0x01<CR></pre>
DISPLAY?	Get output HPD status.	<p>COMMAND</p> <pre>#DISPLAY?_out_index<CR></pre> <p>FEEDBACK</p> <pre>~nn@DISPLAY_out_index,status<CR><LF></pre>	<p>out_index – Number that indicates the specific output:</p> <p>1 – HDMI 1</p> <p>status – HPD status according to signal validation</p> <p>0 – Off 1 – On</p>	<p>Get the output HPD status of Output 1:</p> <pre>#DISPLAY?_1<CR></pre>
ETH-PORT TCP	<p>Set Ethernet port protocol.</p> <p>i If the port number you enter is already in use, an error is returned.</p> <p>The port number must be within the following range: 0-(2¹⁶-1).</p>	<p>COMMAND</p> <pre>#ETH-PORT_portType,port_id<CR></pre> <p>FEEDBACK</p> <pre>~nn@ETH-PORT_portType,port_id<CR><LF></pre>	<p>portType – TCP</p> <p>Port_id – TCP port number</p> <p>TCP – 1-65535</p>	<p>Set TCP port number to 5000:</p> <pre>#ETH-PORT_TCP,5000<CR></pre>
ETH-PORT? TCP	Get Ethernet port protocol.	<p>COMMAND</p> <pre>#ETH-PORT?_port_type<CR></pre> <p>FEEDBACK</p> <pre>~nn@ETH-PORT?_port_type,port_id<CR><LF></pre>	<p>portType – TCP</p> <p>Port_id – TCP port number</p> <p>TCP – 1-65535</p>	<p>Get the Ethernet port number for UDP:</p> <pre>#ETH-PORT?_TCP<CR></pre>
ETH-PORT UDP	<p>Set Ethernet port protocol.</p> <p>i If the port number you enter is already in use, an error is returned.</p> <p>The port number must be within the following range: 0-(2¹⁶-1).</p>	<p>COMMAND</p> <pre>#ETH-PORT_portType,port_id<CR></pre> <p>FEEDBACK</p> <pre>~nn@ETH-PORT_portType,port_id<CR><LF></pre>	<p>portType –UDP</p> <p>Port_id –UDP port number</p> <p>UDP – 1-65535</p>	<p>Set UDP port number to 50000:</p> <pre>#ETH-PORT_UDP,50000<CR></pre>
ETH-PORT? UDP	Get Ethernet port protocol.	<p>COMMAND</p> <pre>#ETH-PORT?_port_type<CR></pre> <p>FEEDBACK</p> <pre>~nn@ETH-PORT?_port_type,port_id<CR><LF></pre>	<p>portType –UDP</p> <p>Port_id –UDP port number</p> <p>UDP – 1-65535</p>	<p>Get the Ethernet port number for UDP:</p> <pre>#ETH-PORT?_UDP<CR></pre>
FACTORY	<p>Reset device to factory default configuration.</p> <p>i This command deletes all user data from the device. The deletion can take some time.</p> <p>Your device may require powering off and powering on for the changes to take effect.</p>	<p>COMMAND</p> <pre>#FACTORY<CR></pre> <p>FEEDBACK</p> <pre>~nn@FACTORY_ok<CR><LF></pre>		<p>Reset the device to factory default configuration:</p> <pre>#FACTORY<CR></pre>

Function	Description	Syntax	Parameters/Attributes	Example
HDCP-MOD	<p>Set HDCP mode.</p> <p>① Set HDCP working mode on the device input:</p> <p>HDCP supported - HDCP_ON [default].</p> <p>HDCP not supported - HDCP OFF.</p> <p>HDCP support changes following detected sink - MIRROR OUTPUT.</p> <p>When you define 3 as the mode, the HDCP status is defined according to the connected output in the following priority: OUT 1, OUT 2. If the connected display on OUT 2 supports HDCP, but OUT 1 does not, then HDCP is defined as not supported. If OUT 1 is not connected, then HDCP is defined by OUT 2.</p>	<p>COMMAND</p> <pre>#HDCP-MOD_{io_mode,io_index,mode}<CR></pre> <p>FEEDBACK</p> <pre>~nn@HDCP-MOD_{io_mode,in_index,mode}<CR><LF></pre>	<p>io_mode – Input/Output</p> <p>0 – Input</p> <p>1 – Output</p> <p>io_index – Input/Output</p> <p>For inputs:</p> <p>1 – HDMI1</p> <p>2 – HDMI2</p> <p>3 – HDMI3</p> <p>4 – HDMI4</p> <p>For outputs:</p> <p>1 – HDMI</p> <p>2 – HDBT</p> <p>mode – HDCP mode:</p> <p>For Inputs:</p> <p>0 – HDCP Off</p> <p>1 – HDCP On</p> <p>For outputs:</p> <p>2 – Follow Input</p> <p>3 – Follow Output</p>	<p>Set the input HDCP-MODE of IN 1 to Off:</p> <pre>#HDCP-MOD_{0,1,0}<CR></pre>
HDCP-MOD?	<p>Get HDCP mode.</p> <p>① Set HDCP working mode on the device input:</p> <p>HDCP supported - HDCP_ON [default].</p> <p>HDCP not supported - HDCP OFF.</p> <p>HDCP support changes following detected sink - MIRROR OUTPUT.</p>	<p>COMMAND</p> <pre>#HDCP-MOD?_{io_mode,io_index}<CR></pre> <p>FEEDBACK</p> <pre>~nn@HDCP-MOD_{io_mode,io_index,mode}<CR><LF></pre>	<p>io_mode – Input/Output</p> <p>0 – Input</p> <p>1 – Output</p> <p>io_index – Input/Output</p> <p>For inputs:</p> <p>1 – HDMI1</p> <p>2 – HDMI2</p> <p>3 – HDMI3</p> <p>4 – HDMI4</p> <p>For outputs:</p> <p>1 – HDMI</p> <p>2 – HDBT</p> <p>mode – HDCP mode:</p> <p>For Inputs:</p> <p>0 – HDCP Off</p> <p>1 – HDCP On</p> <p>For outputs:</p> <p>2 – Follow Input</p> <p>3 – Follow Output</p>	<p>Get the input HDCP-MODE of IN 1 HDMI:</p> <pre>#HDCP-MOD?_{1}<CR></pre>
HDCP-STAT?	<p>Get HDCP signal status</p> <p>① Output stage (1) – get the HDCP signal status of the sink device connected to the specified output.</p> <p>Input stage (0) – get the HDCP signal status of the source device connected to the specified input.</p>	<p>COMMAND</p> <pre>#HDCP-MOD?_{io_mode,io_index}<CR></pre> <p>FEEDBACK</p> <pre>~nn@HDCP-MOD_{io_mode,io_index,mode}<CR><LF></pre>	<p>io_mode – Input/Output</p> <p>0 – Input</p> <p>1 – Output</p> <p>io_index – Input/Output</p> <p>For inputs:</p> <p>1 – HDMI1</p> <p>2 – HDMI2</p> <p>3 – HDMI3</p> <p>4 – HDMI4</p> <p>For outputs:</p> <p>1 – HDMI</p> <p>2 – HDBT</p> <p>mode – HDCP mode:</p> <p>0 – HDCP Off</p> <p>1 – HDCP type 1.4</p> <p>2 – HDCP Type 2.2</p>	<p>Get the input HDCP-MODE of IN 1 HDMI:</p> <pre>#HDCP-MOD?_{0,1}<CR></pre>
HELP	<p>Get command list or help for specific command.</p>	<p>COMMAND</p> <pre>#HELP<CR></pre> <p>#HELP_{cmd_name}<CR></p> <p>FEEDBACK</p> <p>1. Multi-line:</p> <pre>~nn@Device_{cmd_name,{cmd_name..}<CR><LF></pre> <p>To get help for command use: HELP (COMMAND_NAME)<CR><LF></p> <pre>~nn@HELP_{cmd_name:<CR><LF></pre> <p>description<CR><LF></p> <p>USAGE:usage<CR><LF></p>	<p>cmd_name – Name of a specific command</p>	<p>Get the command list:</p> <pre>#HELP<CR></pre> <p>To get help for AV-SW-TIMEOUT:</p> <pre>HELP_{av-sw-timeout}<CR></pre>
IMAGE-PROP	<p>Set the image aspect ratio for each window.</p>	<p>COMMAND</p> <pre>#IMAGE-PROP_{win_num,mode}<CR></pre> <p>FEEDBACK</p> <pre>~nn@IMAGE-PROP_{p1,mode}<CR><LF></pre>	<p>win_num – Window number for setting horizontal sharpness</p> <p>1 – Win 1</p> <p>2 – Win 2</p> <p>3 – Win 3</p> <p>4 – Win 4</p> <p>mode – Status</p> <p>0 – Full</p> <p>1 – 16:9</p> <p>2 – 16:10</p> <p>3 – 4:3</p> <p>4 – Best Fit</p> <p>5 – User</p>	<p>Set the win 1 aspect ratio to full:</p> <pre>#IMAGE-PROP_{1,0}<CR></pre>

Function	Description	Syntax	Parameters/Attributes	Example
IMAGE-PROP?	Get the image properties. ① Gets the image properties of the selected scaler.	COMMAND #IMAGE-PROP?_win_num <CR> FEEDBACK ~nn@IMAGE-PROP_win_num,mode<CR><LF>	win_num – Window number for setting horizontal sharpness 1 – Win 1 2 – Win 2 3 – Win 3 4 – Win 4 mode – Status 0 – Full 1 – 16:9 2 – 16:10 3 – 4:3 4 – Best Fit 5 – User	Get the win 1 aspect ratio: #IMAGE-PROP?_1<CR>
LOCK-FP	Lock the front panel.	COMMAND #LOCK-FP_lock/unlock<CR> FEEDBACK ~nn@LOCK-FP_lock/unlock<CR><LF>	lock/unlock – On/Off 0 – No (unlock) 1 – Yes (lock)	Unlock front panel: #LOCK-FP_0<CR>
LOCK-FP?	Get the front panel lock state.	COMMAND #LOCK-FP?_<CR> FEEDBACK ~nn@LOCK-FP_lock/unlock<CR><LF>	lock/unlock – On/Off 0 – No (unlock) 1 – Yes (lock)	Get the front panel lock state: #LOCK-FP?<CR>
MODEL?	Get device model.	COMMAND #MODEL?_<CR> FEEDBACK ~nn@MODEL_model_name<CR><LF>	model_name – String of up to 19 printable ASCII chars	Get the device model: #MODEL?_<CR>
MUTE	Set audio mute.	COMMAND #MUTE_channel,mute_mode<CR> FEEDBACK ~nn@MUTE_channel,mute_mode<CR><LF>	channel – number of outputs: 1 – HDMI 2 – HDBT mute_mode – On/Off 0 – Off 1 – On	Set Output 1 to mute: #MUTE_1,1<CR>
MUTE?	Get audio mute.	COMMAND #MUTE?_channel<CR> FEEDBACK ~nn@MUTE_channel,mute_mode<CR><LF>	channel – number of outputs: 1 – HDMI 2 – HDBT mute_mode – On/Off 0 – Off 1 – On	Get mute status of output 1 #MUTE_1?<CR>
NAME	Set machine (DNS) name. ① The machine name is not the same as the model name. The machine name is used to identify a specific machine or a network in use (with DNS feature on).	COMMAND #NAME_machine_name<CR> FEEDBACK ~nn@NAME_machine_name<CR><LF>	machine_name – String of up to 15 alpha-numeric chars (can include hyphen, not at the beginning or end)	Set the DNS name of the device to room-442: #NAME_room-442<CR>
NAME?	Get machine (DNS) name. ① The machine name is not the same as the model name. The machine name is used to identify a specific machine or a network in use (with DNS feature on).	COMMAND #NAME?_<CR> FEEDBACK ~nn@NAME_machine_name<CR><LF>	machine_name – String of up to 15 alpha-numeric chars (can include hyphen, not at the beginning or end)	Get the DNS name of the device: #NAME?_<CR>
NET-DHCP	Set DHCP mode. ① Only 1 is relevant for the mode value. To disable DHCP, the user must configure a static IP address for the device. Connecting Ethernet to devices with DHCP may take more time in some networks. To connect with a randomly assigned IP by DHCP, specify the device DNS name (if available) using the NAME command. You can also get an assigned IP by direct connection to USB or RS-232 protocol port, if available. For proper settings consult your network administrator. ① For Backward compatibility, the id parameter can be omitted. In this case, the Network ID, by default, is 0, which is the Ethernet control port.	COMMAND #NET-DHCP_mode<CR> FEEDBACK ~nn@NET-DHCP_mode<CR><LF>	mode – 0 – Static 1 – DHCP	Enable DHCP mode for port 1, if available: #NET-DHCP_1<CR>
NET-DHCP?	Get DHCP mode. ① For Backward compatibility, the id parameter can be omitted. In this case, the Network ID, by default, is 0, which is the Ethernet control port.	COMMAND #NET-DHCP?_<CR> FEEDBACK ~nn@NET-DHCP_mode<CR><LF>	mode – 0 – Static 1 – DHCP	Get DHCP mode for port: #NET-DHCP?_<CR>

Function	Description	Syntax	Parameters/Attributes	Example
NET-GATE	Set gateway IP. ① A network gateway connects the device via another network and maybe over the Internet. Be careful of security issues. For proper settings consult your network administrator.	COMMAND #NET-GATE_ip_address<CR> FEEDBACK ~nn@NET-GATE_ip_address<CR><LF>	ip_address – Format: xxx.xxx.xxx.xxx	Set the gateway IP address to 192.168.0.1: #NET-GATE_192.168.000.001<CR>
NET-GATE?	Get gateway IP. ① A network gateway connects the device via another network and maybe over the Internet. Be aware of security problems.	COMMAND #NET-GATE?_<CR> FEEDBACK ~nn@NET-GATE_ip_address<CR><LF>	ip_address – Format: xxx.xxx.xxx.xxx	Get the gateway IP address: #NET-GATE?_<CR>
NET-IP	Set IP address. ① For proper settings consult your network administrator.	COMMAND #NET-IP_ip_address<CR> FEEDBACK ~nn@NET-IP_ip_address<CR><LF>	ip_address – Format: xxx.xxx.xxx.xxx	Set the IP address to 192.168.1.39: #NET-IP_192.168.001.039<CR>
NET-IP?	Get IP address.	COMMAND #NET-IP?_<CR> FEEDBACK ~nn@NET-IP_ip_address<CR><LF>	ip_address – Format: xxx.xxx.xxx.xxx	Get the IP address: #NET-IP?_<CR>
NET-MAC	Get MAC address. ① For backward compatibility, the id parameter can be omitted. In this case, the Network ID, by default, is 0, which is the Ethernet control port.	COMMAND #NET-MASK_id<CR> FEEDBACK ~nn@NET-MASK_id,mac_address<CR><LF>	id – Network ID—the device network interface (if there are more than one). Counting is 0 based, meaning the control port is '0', additional ports are 1,2,3.... mac_address – Unique MAC address. Format: XX-XX-XX-XX-XX-XX where X is hex digit	#NET-MAC?_id<CR>
NET-MASK	Set subnet mask. ① For proper settings consult your network administrator.	COMMAND #NET-MASK_net_mask<CR> FEEDBACK ~nn@NET-MASK_net_mask<CR><LF>	net_mask – Format: xxx.xxx.xxx.xxx	Set the subnet mask to 255.255.0.0: #NET-MASK_255.255.000.000<CR>
NET-MASK?	Get subnet mask.	COMMAND #NET-MASK?_<CR> FEEDBACK ~nn@NET-MASK_net_mask<CR><LF>	net_mask – Format: xxx.xxx.xxx.xxx	Get the subnet mask: #NET-MASK?<CR>
PROT-VER?	Get device protocol version.	COMMAND #PROT-VER?_<CR> FEEDBACK ~nn@PROT-VER_3000:version<CR><LF>	version – XX.XX where X is a decimal digit	Get the device protocol version: #PROT-VER?_<CR>
PRST-RCL	Recall saved preset list. ① In most units, video and audio presets with the same number are stored and recalled together by commands #PRST-STO and #PRST-RCL.	COMMAND #PRST-RCL_preset<CR> FEEDBACK ~nn@PRST-RCL_preset<CR><LF>	preset – Preset number 1-4	Recall preset 1: #PRST-RCL_1<CR>
PRST-STO	Store current connections, volumes and modes in preset. ① In most units, video and audio presets with the same number are stored and recalled together by commands #PRST-STO and #PRST-RCL.	COMMAND #PRST-STO_preset<CR> FEEDBACK ~nn@PRST-STO_preset<CR><LF>	preset – Preset number1-4	Store preset 1: #PRST-STO_1<CR>
RESET	Reset device. ① To avoid locking the port due to a USB bug in Windows, disconnect USB connections immediately after running this command. If the port was locked, disconnect and reconnect the cable to reopen the port.	COMMAND #RESET<CR> FEEDBACK ~nn@RESET_ok<CR><LF>		Reset the device: #RESET<CR>
ROTATE	Set image rotation. ① To rotate the image, Aspect Ratio should be set to Full, and Mirror and Border features set to off.	COMMAND #ROTATE_out_id,in_id,angle<CR> FEEDBACK ~nn@ROTATE_out_id,in_id,angle<CR><LF>	out_id – 1 – Output win_id – For inputs: 1 IN 1 2 – IN 2 3 – IN 3 4 – IN 4 angle – For inputs: 0 – Off 1 – 90 degrees to the left 2 – 90 degrees to the right 3 – 180 degrees 4 – Mirror	Set IN 1 rotation to 180 degrees: #ROTATE_1,1,3<CR>

Function	Description	Syntax	Parameters/Attributes	Example
ROTATE?	Get image rotation ① To rotate the image, Aspect Ratio should be set to Full, and Mirror and Border features set to off.	COMMAND #ROTATE?_out_id,in_id<CR> FEEDBACK ~nn@#ROTATE_out_id,in_id,angle<CR><LF>	out_id – 1 – Output win_id – For inputs: 1 – IN 1 2 – IN 2 3 – IN 3 4 – IN 4 angle – For inputs: 0 – Off 1 – 90 degrees to the left 2 – 90 degrees to the right 3 – 180 degrees 4 – Mirror	Get rotation state of IN 3: #ROTATE?_1,3<CR>
ROUTE	Set layer routing. ① This command replaces all other routing commands.	COMMAND #ROUTE_layer,dest,src<CR> FEEDBACK ~nn@ROUTE_layer,dest,src<CR><LF>	layer – Layer Enumeration 1 – Video 2 – Audio dest 1 – OUT A 2 – OUT B src – Source id 1 – HDMI1 2 – HDMI2 3 – HDMI3 4 – HDMI4 5 – Off (not including audio)	Route video HDMI 2 to video OUT 1: #ROUTE_1,1,2<CR>
ROUTE?	Get layer routing. ① This command replaces all other routing commands.	COMMAND #ROUTE?_layer,dest<CR> FEEDBACK ~nn@ROUTE_layer,dest,src<CR><LF>	layer – Layer Enumeration 1 – Video 2 – Audio dest 1 – OUT A 2 – OUT B src – Source id 1 – HDMI1 2 – HDMI2 3 – HDMI3 4 – HDMI4 5 – Off (not including audio)	Get the layer routing for output 1: #ROUTE?_1,1<CR>
RSTWIN	Reset window	COMMAND #RSTWIN_win_id<CR> FEEDBACK ~nn@RSTWIN_win_id,ok<CR><LF>	win_id – Window id 1 – Win 1 2 – Win 2 3 – Win 3 4 – Win 4	Reset window 1: #RSTWIN_1<CR>
SCLR-AS	Set auto-sync features. ① Sets the auto sync features for the selected scaler.	COMMAND #SCLR-AS_scaler,sync_speed<CR> FEEDBACK ~nn@SCLR-AS_scaler,sync_speed<CR><LF>	Scaler – 1 Sync_speed – 0 – Disable 1 – Slow 2 – Fast	Set auto-sync feature to slow: #SCLR-AS_1,1<CR>
SCLR-AS?	Get auto-sync features. ① Gets the auto sync features for the selected scaler.	COMMAND #SCLR-AS?_scaler<CR> FEEDBACK ~nn@SCLR-AS_scaler,sync_speed<CR><LF>	Scaler – 1 Sync_speed – 0 – Disable 1 – Slow 2 – Fast	Get auto-sync features: #SCLR-AS?_1<CR>
SHOW-OSD	Set the OSD state.	COMMAND #SHOW-OSD_id,state<CR> FEEDBACK ~nn@SHOW-OSD_id,state<CR><LF>	id – 1 state – On/Off 0 – Off 1 – On 2 – Info	Set the OSD to on: #SHOW-OSD_1,1<CR>
SHOW-OSD?	Get the OSD state.	COMMAND #SHOW-OSD?_id<CR> FEEDBACK ~nn@SHOW-OSD_id,state<CR><LF>	id – 1 state – On/Off 0 – Off 1 – On 2 – Info	Get the OSD state: #SHOW-OSD?_1<CR>
SIGNAL?	Get input signal status.	COMMAND #SIGNAL?_inp_id<CR> FEEDBACK ~nn@SIGNAL_inp_id,status<CR><LF>	Input_id – Input number 1 – IN 1 HDMI 2 – IN 1 HDBT status – Signal status according to signal validation: 0 – Off 1 – On	Get the input signal lock status of IN 1: #SIGNAL?_1<CR>
SN?	Get device serial number.	COMMAND #SN?_<CR> FEEDBACK ~nn@SN_serial_number<CR><LF>	serial_num – 14 decimal digits, factory assigned	Get the device serial number: #SN?_<CR>
STANDBY	Set standby mode.	COMMAND #STANDBY_on_off<CR> FEEDBACK ~nn@STANDBY_value<CR><LF>	value – On/Off 0 – Off 1 – On	Set standby mode: #STANDBY_1<CR>
STANDBY?	Get standby mode status.	COMMAND #STANDBY?_<CR> FEEDBACK ~nn@STANDBY_value<CR><LF>	value – On/Off 0 – Off 1 – On	Get standby mode status: #STANDBY?_<CR>
UPDATE-EDID	Upload the User EDID	COMMAND #UPDATE-EDID_edid_user<CR> FEEDBACK ~nn@UPDATE-EDID_edid_user<CR><LF>	value – On/Off 1 – User 1 2 – User 2 3 – User 3 4 – User 4	Upload EDID to User 2: #UPDATE-EDID_2<CR>

Function	Description	Syntax	Parameters/Attributes	Example
UPDATE-MCU	Update firmware using USB flash drive	COMMAND #UPDATE-MCU<CR> FEEDBACK ~nn@UPDATE-MCU_ok<CR><LF>		Reset the device: #UPDATE-MCU<CR>
VERSION?	Get firmware version number.	COMMAND #VERSION?_<CR> FEEDBACK ~nn@VERSION_firmware_version<CR><LF>	firmware_version – XX.XX.XXXX where the digit groups are: major.minor.build version	Get the device firmware version number: #VERSION?_<CR>
VID-RES	Set output resolution.	COMMAND #VID-RES_io_mode,io_index,is_native,resolution<CR> FEEDBACK ~nn@VID-RES_io_mode,io_index,is_native,resolution<CR><LF>	io_mode – Input/Output 0 – Input 1 – Output io_index – Number that indicates the specific input or output port: For inputs: 1 – HDMI 1 2 – HDMI 2 3 – HDMI 3 4 – HDMI 4 For outputs: 1 – HDMI 2 – HDBT is_native – Native resolution flag 0 – Off 1 – On resolution – Resolution index 0=OUT A Native 1=OUT B Native 2=640X480P @59Hz 3=720X480P @60Hz 4=720X576P @50Hz, 5=800X600P @60Hz, 6=848X480P @60Hz, 7=1024X768P @60Hz, 8=1280X720P @50Hz, 9=1280X720P @60Hz, 10=1280X768P @60Hz, 11=1280X800P @60Hz, 12=1280X960P @60Hz, 13=1280X1024P @60Hz, 14=1360X768P @60Hz, 15=1366X768P @60Hz, 16=1400X1050P @60Hz, 17=1440X900P @60Hz, 18=1600X900P @60RBHz, 19=1600X1200P @60Hz, 20=1680X1050P @60Hz, 21=1920X1080P @24Hz, 22=1920X1080P @25Hz, 23=1920X1080P @30Hz, 24=1920X1080P @50Hz, 25=1920X1080P @60Hz, 26=1920X1200P @60HzRB, 27=2048X1152P @60HzRB, 28=3840X2160P @24Hz, 29=3840X2160P @25Hz, 30=3840X2160P @30Hz, 31=4096X2160P @24Hz, 32=4096X2160P @25Hz, 33=R4096X2160P @30Hz, 34=4096X2160P @50Hz, 35=4096X2160P @59Hz, 36=4096X2160P @60Hz, 37=3840X2160P @50Hz, 38=3840X2160P @59Hz, 39=3840X2160P @60Hz, 40=3840X2400P @60Hz RB	Set output resolution: #VID-RES_1,1,1,1<CR>

Function	Description	Syntax	Parameters/Attributes	Example
VID-RES?	Get output resolution.	COMMAND #VID-RES?_io_mode,io_index,is_native<CR> FEEDBACK ~nn@VID-RES?_io_mode,io_index,is_native,resoluti on<CR><LF>	io_mode – Input/Output 0 – Input 1 – Output io_index – Number that indicates the specific input or output port: 1-N (N= the total number of input or output ports) is_native – Native resolution flag 0 – Off 1 – On resolution – Resolution index 0=OUT A Native 1=OUT B Native 2=640X480P@59Hz 3=720X480P@60Hz 4=720X576P@50Hz, 5=800X600P@60Hz, 6=848X480P@60Hz, 7=1024X768P@60Hz, 8=1280X720P@50Hz, 9=1280X720P@60Hz, 10=1280X768P@60Hz, 11=1280X800P@60Hz, 12=1280X960P@60Hz, 13=1280X1024P@60Hz, 14=1360X768P@60Hz, 15=1366X768P@60Hz, 16=1400X1050P@60Hz, 17=1440X900P@60Hz, 18=1600X900P@60RBHz, 19=1600X1200P@60Hz, 20=1680X1050P@60Hz, 21=1920X1080P@24Hz, 22=1920X1080P@25Hz, 23=1920X1080P@30Hz, 24=1920X1080P@50Hz, 25=1920X1080P@60Hz, 26=1920X1200P@60HzRB, 27=2048X1152P@60HzRB, 28=3840X2160P@24Hz, 29=3840X2160P@25Hz, 30=3840X2160P@30Hz, 31=4096X2160P@24Hz, 32=4096X2160P@25Hz, 33=R4096X2160P@30Hz, 34=4096X2160P@50Hz, 35=4096X2160P@59Hz, 36=4096X2160P@60Hz, 37=3840X2160P@50Hz, 38=3840X2160P@59Hz, 39=3840X2160P@60Hz, 40=3840X2400P@60Hz RB	Set output resolution: #VID-RES?_1,1,1<CR>
VIEW-MOD	Set view mode.	COMMAND #VIEW-MOD_mode<CR> FEEDBACK ~nn@VIEW-MOD_mode<CR><LF>	mode – View Modes 0 – Matrix 1 – PIP (3) 2 – PoP side 3 – Quad 4 – PoP Side (2) 5 – Preset 1 6 – Preset 2 7 – Preset 3 8 – Preset 4	Set view mode to Matrix: #VIEW-MOD_0<CR>
VIEW-MOD?	Get view mode.	COMMAND #VIEW-MOD?_<CR> FEEDBACK ~nn@VIEW-MOD_mode<CR><LF>	mode – View Modes 0 – Matrix 1 – PIP (3) 2 – PoP side 3 – Quad 4 – PoP Side (2) 5 – Preset 1 6 – Preset 2 7 – Preset 3 8 – Preset 4	Get view mode: #VIEW-MOD?_<CR>
W-COLOR	Set window border color intensity. ① Value limits can vary for different devices. Depending on used color space, device firmware might make a translation from value to RGB/YCbCr.... Value is a property of input connected to current window. Changing window input source might cause changes in this value (refer to device definitions).	COMMAND #W-COLOR_win_num,value<CR> FEEDBACK ~nn@W-COLOR_win_num,value<CR><LF>	win_num – Window number for setting contrast 1 – Win 1 2 – Win 2 3 – Win 3 4 – Win 4 value – Border color: 1 – Black 2 – Red 3 – Green 4 – Blue 5 – Yellow 6 – Magenta 7 – Cyan 8 – White 9 – Dark Red 10 – Dark Green 11 – Dark Blue 12 – Dark Yellow 13 – Dark Magenta 14 – Dark Cyan 15 – Gray	Set window 1 border color intensity to black: #W-COLOR_1,1<CR>

Function	Description	Syntax	Parameters/Attributes	Example
W-COLOR?	Get window border color.	COMMAND #W-COLOR?_win_num<CR> FEEDBACK ~nn@W-COLOR_win_num,value<CR><LF>	win_num – Window number for setting contrast 1 – Win 1 2 – Win 2 3 – Win 3 4 – Win 4 value – Border color: 1 – Black 2 – Red 3 – Green 4 – Blue 5 – Yellow 6 – Magenta 7 – Cyan 8 – White 9 – Dark Red 10 – Dark Green 11 – Dark Blue 12 – Dark Yellow 13 – Dark Magenta 14 – Dark Cyan 15 – Gray	Get window 1 border color: #W-COLOR?_1<CR>
W-ENABLE	Set window visibility.	COMMAND #W-ENABLE_win_num,enable_flag<CR> FEEDBACK ~nn@W-ENABLE_win_num,enable_flag<CR><LF>	win_num – Window number to enable/disable 1 – Win 1 2 – Win 2 3 – Win 3 4 – Win 4 enable_flag – On/Off 0 – Off 1 – On	Set window 1 visibility on: #W-ENABLE_1,1<CR>
W-ENABLE?	Get window visibility status.	COMMAND #W-ENABLE?_win_num<CR> FEEDBACK ~nn@W-ENABLE_win_num,enable_flag<CR><LF>	win_num – Window number to enable/disable 1 – Win 1 2 – Win 2 3 – Win 3 4 – Win 4 enable_flag – On/Off 0 – Off 1 – On	Get window 1 visibility status: #W-ENABLE?_1<CR>
W-HUE	Set window hue value. ① Value limits can vary for different devices. Value is a property of input connected to current window. Changing window input source might cause changes in this value (refer device definitions).	COMMAND #W-HUE_win_num,value<CR> FEEDBACK ~nn@W-HUE_win_num,value<CR><LF>	win_num – Window number for setting hue 1 – Win 1 2 – Win 2 3 – Win 3 4 – Win 4 value – Hue value:0-100	Set window hue value: #W-HUE_1,1<CR>
W-HUE?	Get window hue value. ① Value limits can vary for different devices. Value is a property of input connected to current window. Changing window input source might cause changes in this value (refer device definitions).	COMMAND #W-HUE?_win_num<CR> FEEDBACK ~nn@W-HUE_win_num,value<CR><LF>	win_num – Window number for setting hue 1 – Win 1 2 – Win 2 3 – Win 3 4 – Win 4 value – Hue value: 0-100	Get window 1 hue value: #W-HUE?_1<CR>
W-LAYER	Set window overlay order. Set all window overlay orders. ① In case of overlays order list, number of expected layers is maximum number of windows in device.	COMMAND #W-LAYER_win_num,value<CR> #W-LAYER_0xFF,value1,value2,...,valueN<CR> FEEDBACK Set 1/Get 1: ~nn@W-LAYER_win_num,value<CR><LF> Set 2/Get 2: ~nn@W-LAYER_0xFF,value1,value2,...valueN<CR><LF>	win_num – Window number setting layer 1 – Win 1 2 – Win 2 3 – Win 3 4 – Win 4 value – Layer order: 1 – bottom 2 – 2 layers below top 3 – one layer below top 4 – Top	Set window 1 overlay order to bottom: #W-LAYER_1,1<CR>
W-LAYER?	Get window overlay order. Get all window overlay orders. ① In case of overlays order list, number of expected layers is maximum number of windows in device.	COMMAND #W-LAYER?_win_num<CR> #W-LAYER?_0xFF<CR> FEEDBACK Set 1/Get 1: ~nn@W-LAYER_win_num,value<CR><LF> Set 2/Get 2: ~nn@W-LAYER_0xFF,value1,value2,...valueN<CR><LF>	win_num – Window number for setting layer: 1 – Win 1 2 – Win 2 3 – Win 3 4 – Win 4 value – Layer order: 1 – bottom 2 – 2 layers below top 3 – one layer below top 4 – Top	Get window 1 overlay order: #W-LAYER?_1<CR>
WND-BRD	Enable/disable window border.	COMMAND #WND-BRD_win_num,enable<CR> FEEDBACK ~nn@WND-BRD_win_num,enable<CR><LF>	win_num – Window number for setting border: 1 – Win 1 2 – Win 2 3 – Win 3 4 – Win 4 value – 0 – Disable 1 – Enable	Enable window 1 border: #WND-BRD_1,1<CR>

Function	Description	Syntax	Parameters/Attributes	Example
WND-BRD?	Get window border status.	COMMAND #WND-BRD?_win_num<CR> FEEDBACK ~nn@WND-BRD_win_num,enable<CR><LF>	win_num – Window number for setting border: 1 – Win 1 2 – Win 2 3 – Win 3 4 – Win 4 value – 0 – Disable 1 – Enable	Get window 1 border status: #WND-BRD?_1<CR>
W-P-DEFAULT	Set specific window parameters to their default value.	COMMAND #W-P-DEFAULT_win_num<CR> FEEDBACK ~nn@W-P-DEFAULT_win_num<CR><LF>	win_num – Number that indicates the specific window: 1 – Win 1 2 – Win 2 3 – Win 3 4 – Win 4	Reset window 1 to its default parameters: #W-P-DEFAULT_1<CR>
W-POS	Set window position.	COMMAND #W-POS_win_num,left,top,width,height<CR> FEEDBACK ~nn@W-POS_win_num,left,top,width,height<CR><LF>	win_num – Number that indicates the specific window: 1 – Win 1 2 – Win 2 3 – Win 3 4 – Win 4 left – Left coordinate top – Top coordinate width – Window width height – Window height	Set window 1 position: #W-POS_1,205,117,840,472<CR>
W-POS?	Get window position.	COMMAND #W-POS?_win_num<CR> FEEDBACK ~nn@W-POS_win_num,left,top,width,height<CR><LF>	win_num – Number that indicates the specific window: 1 – Win 1 2 – Win 2 3 – Win 3 4 – Win 4 left – Left coordinate top – Top coordinate width – Window width height – Window height	Get window 1 position: #W-POS?_1<CR>
W-SATURATION	Set image saturation per output. ① Value limits can vary for different devices. Value is a property of input connected to current output. Changing input source might cause changes in this value (refer device definitions). In devices that enable showing multiple outputs on one display – each in a separate window – this command relates only to the window associated with the output indicated in the out-index parameter.	COMMAND #W-SATURATION_win_num,value<CR> FEEDBACK ~nn@W-SATURATION_win_num,value<CR><LF>	win_num – Window number for setting saturation 1 – Win 1 2 – Win 2 3 – Win 3 4 – Win 4 value – Saturation value: 0-100	Set saturation for Win 1 to 50: #W-SATURATION_1,50<CR>
W-SATURATION?	Get image saturation per output. ① Value limits can vary for different devices. Value is a property of input connected to current output. Changing input source might cause changes in this value (refer device definitions). In devices that enable showing multiple outputs on one display – each in a separate window – this command relates only to the window associated with the output indicated in the out-index parameter.	COMMAND #W-SATURATION?_win_num<CR> FEEDBACK ~nn@W-SATURATION_win_num,value<CR><LF>	win_num – Window number for setting saturation 1 – Win 1 2 – Win 2 3 – Win 3 4 – Win 4 value – Saturation value: 0-100	Get saturation for output 1: #W-SATURATION?_1<CR>
W-SHARP-H	Set horizontal sharpness.	COMMAND #W-SHARP-H_win_num,value<CR> FEEDBACK ~nn@W-SHARP-H_win_num,value<CR><LF>	win_num – Window number for setting horizontal sharpness 1 – Win 1 2 – Win 2 3 – Win 3 4 – Win 4 value – H sharpness value:0-100	Set window 1 H sharpness value to 20: #W-SHARPNESS-H_1,20<CR>
W-SHARP-H?	Get horizontal sharpness.	COMMAND #W-SHARP-H?_win_num<CR> FEEDBACK ~nn@W-SHARP-H_win_num,value<CR><LF>	win_num – Window number for setting horizontal sharpness 1 – Win 1 2 – Win 2 3 – Win 3 4 – Win 4 value – H sharpness value:0-100	Get window 1 H sharpness value to 20: #W-SHARPNESS-H?_1<CR>
W-SHARP-V	Set vertical sharpness.	COMMAND #W-SHARP-V_win_num,value<CR> FEEDBACK ~nn@W-SHARP-V_win_num,value<CR><LF>	win_num – Window number for setting vertical sharpness 1 – Win 1 2 – Win 2 3 – Win 3 4 – Win 4 value – V sharpness value:0-100	Set window 1 V sharpness value to 20: #W-SHARPNESS-V_1,20<CR>

Function	Description	Syntax	Parameters/Attributes	Example
W-SHARP-V?	Get vertical sharpness.	COMMAND #W-SHARP-V?_win_num<CR> FEEDBACK ~nn@W-SHARP-V,_win_num,value<CR><LF>	win_num – Window number for setting vertical sharpness 1 – Win 1 2 – Win 2 3 – Win 3 4 – Win 4 value – V sharpness value:0-100	Get window 1 V sharpness value to 20: #W-SHARPNESS-V?_1<CR>
W-SRC	Set window source. <i>i</i> src limits can vary for different devices.	COMMAND #W-SRC?_win_num,src<CR> FEEDBACK ~nn@W-SRC,_win_num,src<CR><LF>	out_index – Number that indicates the specific window: 1 – Win 1 2 – Win 2 3 – Win 3 4 – Win 4 src – Input source to connect to window 1 – HDMI 1 2 – HDMI 2 3 – HDMI 3 4 – HDMI 4	Set window 1 source to HDMI 1: #W-SRC?_1,1<CR>
W-SRC?	Get window source. <i>i</i> src limits can vary for different devices.	COMMAND #W-SRC?_win_num<CR> FEEDBACK ~nn@W-SRC,_win_num,src<CR><LF>	out_index – Number that indicates the specific window: 1 – Win 1 2 – Win 2 3 – Win 3 4 – Win 4 src – Input source to connect to window 1 – HDMI 1 2 – HDMI 2 3 – HDMI 3 4 – HDMI 4	Get window 1 source: #W-SRC?_1<CR>

Result and Error Codes

Syntax

In case of an error, the device responds with an error message. The error message syntax:

- **~NN@ERR XXX<CR><LF>** – when general error, no specific command
- **~NN@CMD ERR XXX<CR><LF>** – for specific command
- **NN** – machine number of device, default = 01
- **XXX** – error code

Error Codes

Error Name	Error Code	Description
P3K_NO_ERROR	0	No error
ERR_PROTOCOL_SYNTAX	1	Protocol syntax
ERR_COMMAND_NOT_AVAILABLE	2	Command not available
ERR_PARAMETER_OUT_OF_RANGE	3	Parameter out of range
ERR_UNAUTHORIZED_ACCESS	4	Unauthorized access
ERR_INTERNAL_FW_ERROR	5	Internal FW error
ERR_BUSY	6	Protocol busy
ERR_WRONG_CRC	7	Wrong CRC
ERR_TIMEDOUT	8	Timeout
ERR_RESERVED	9	(Reserved)
ERR_FW_NOT_ENOUGH_SPACE	10	Not enough space for data (firmware, FPGA...)
ERR_FS_NOT_ENOUGH_SPACE	11	Not enough space – file system
ERR_FS_FILE_NOT_EXISTS	12	File does not exist
ERR_FS_FILE_CANT_CREATED	13	File can't be created
ERR_FS_FILE_CANT_OPEN	14	File can't open
ERR_FEATURE_NOT_SUPPORTED	15	Feature is not supported
ERR_RESERVED_2	16	(Reserved)
ERR_RESERVED_3	17	(Reserved)
ERR_RESERVED_4	18	(Reserved)
ERR_RESERVED_5	19	(Reserved)
ERR_RESERVED_6	20	(Reserved)
ERR_PACKET_CRC	21	Packet CRC error
ERR_PACKET_MISSED	22	Packet number isn't expected (missing packet)
ERR_PACKET_SIZE	23	Packet size is wrong
ERR_RESERVED_7	24	(Reserved)
ERR_RESERVED_8	25	(Reserved)
ERR_RESERVED_9	26	(Reserved)
ERR_RESERVED_10	27	(Reserved)
ERR_RESERVED_11	28	(Reserved)
ERR_RESERVED_12	29	(Reserved)
ERR_EDID_CORRUPTED	30	EDID corrupted
ERR_NON_LISTED	31	Device specific errors
ERR_SAME_CRC	32	File has the same CRC – not changed
ERR_WRONG_MODE	33	Wrong operation mode
ERR_NOT_CONFIGURED	34	Device/chip was not initialized

The warranty obligations of Kramer Electronics Inc. ("Kramer Electronics") for this product are limited to the terms set forth below:

What is Covered

This limited warranty covers defects in materials and workmanship in this product.

What is Not Covered

This limited warranty does not cover any damage, deterioration or malfunction resulting from any alteration, modification, improper or unreasonable use or maintenance, misuse, abuse, accident, neglect, exposure to excess moisture, fire, improper packing and shipping (such claims must be presented to the carrier), lightning, power surges, or other acts of nature. This limited warranty does not cover any damage, deterioration or malfunction resulting from the installation or removal of this product from any installation, any unauthorized tampering with this product, any repairs attempted by anyone unauthorized by Kramer Electronics to make such repairs, or any other cause which does not relate directly to a defect in materials and/or workmanship of this product. This limited warranty does not cover cartons, equipment enclosures, cables or accessories used in conjunction with this product.

Without limiting any other exclusion herein, Kramer Electronics does not warrant that the product covered hereby, including, without limitation, the technology and/or integrated circuit(s) included in the product, will not become obsolete or that such items are or will remain compatible with any other product or technology with which the product may be used.

How Long this Coverage Lasts

The standard limited warranty for Kramer products is seven (7) years from the date of original purchase, with the following exceptions:

1. All Kramer VIA hardware products are covered by a standard three (3) year warranty for the VIA hardware and a standard three (3) year warranty for firmware and software updates; all Kramer VIA accessories, adapters, tags, and dongles are covered by a standard one (1) year warranty.
2. Kramer fiber optic cables, adapter-size fiber optic extenders, pluggable optical modules, active cables, cable retractors, ring mounted adapters, portable power chargers, Kramer speakers, and Kramer touch panels are covered by a standard one (1) year warranty. Kramer 7-inch touch panels purchased on or after April 1st, 2020 are covered by a standard two (2) year warranty.
3. All Kramer Calibre products, all Kramer Minicom digital signage products, all HighSecLabs products, all streaming, and all wireless products are covered by a standard three (3) year warranty.
4. All Sierra Video MultiViewers are covered by a standard five (5) year warranty.
5. Sierra switchers & control panels are covered by a standard seven (7) year warranty (excluding power supplies and fans that are covered for three (3) years).
6. K-Touch software is covered by a standard one (1) year warranty for software updates.
7. All Kramer passive cables are covered by a lifetime warranty.

Who is Covered

Only the original purchaser of this product is covered under this limited warranty. This limited warranty is not transferable to subsequent purchasers or owners of this product.

What Kramer Electronics Will Do

Kramer Electronics will, at its sole option, provide one of the following three remedies to whatever extent it shall deem necessary to satisfy a proper claim under this limited warranty:

1. Elect to repair or facilitate the repair of any defective parts within a reasonable period of time, free of any charge for the necessary parts and labor to complete the repair and restore this product to its proper operating condition. Kramer Electronics will also pay the shipping costs necessary to return this product once the repair is complete.
2. Replace this product with a direct replacement or with a similar product deemed by Kramer Electronics to perform substantially the same function as the original product. If a direct or similar replacement product is supplied, the original product's end warranty date remains unchanged and is transferred to the replacement product.
3. Issue a refund of the original purchase price less depreciation to be determined based on the age of the product at the time remedy is sought under this limited warranty.

What Kramer Electronics Will Not Do Under This Limited Warranty

If this product is returned to Kramer Electronics or the authorized dealer from which it was purchased or any other party authorized to repair Kramer Electronics products, this product must be insured during shipment, with the insurance and shipping charges prepaid by you. If this product is returned uninsured, you assume all risks of loss or damage during shipment. Kramer Electronics will not be responsible for any costs related to the removal or re-installation of this product from or into any installation. Kramer Electronics will not be responsible for any costs related to any setting up this product, any adjustment of user controls or any programming required for a specific installation of this product.

How to Obtain a Remedy Under This Limited Warranty

To obtain a remedy under this limited warranty, you must contact either the authorized Kramer Electronics reseller from whom you purchased this product or the Kramer Electronics office nearest you. For a list of authorized Kramer Electronics resellers and/or Kramer Electronics authorized service providers, visit our web site at www.kramerav.com or contact the Kramer Electronics office nearest you.

In order to pursue any remedy under this limited warranty, you must possess an original, dated receipt as proof of purchase from an authorized Kramer Electronics reseller. If this product is returned under this limited warranty, a return authorization number, obtained from Kramer Electronics, will be required (RMA number). You may also be directed to an authorized reseller or a person authorized by Kramer Electronics to repair the product.

If it is decided that this product should be returned directly to Kramer Electronics, this product should be properly packed, preferably in the original carton, for shipping. Cartons not bearing a return authorization number will be refused.

Limitation of Liability

THE MAXIMUM LIABILITY OF KRAMER ELECTRONICS UNDER THIS LIMITED WARRANTY SHALL NOT EXCEED THE ACTUAL PURCHASE PRICE PAID FOR THE PRODUCT. TO THE MAXIMUM EXTENT PERMITTED BY LAW, KRAMER ELECTRONICS IS NOT RESPONSIBLE FOR DIRECT, SPECIAL, INCIDENTAL OR CONSEQUENTIAL DAMAGES RESULTING FROM ANY BREACH OF WARRANTY OR CONDITION, OR UNDER ANY OTHER LEGAL THEORY. Some countries, districts or states do not allow the exclusion or limitation of relief, special, incidental, consequential or indirect damages, or the limitation of liability to specified amounts, so the above limitations or exclusions may not apply to you.

Exclusive Remedy

TO THE MAXIMUM EXTENT PERMITTED BY LAW, THIS LIMITED WARRANTY AND THE REMEDIES SET FORTH ABOVE ARE EXCLUSIVE AND IN LIEU OF ALL OTHER WARRANTIES, REMEDIES AND CONDITIONS, WHETHER ORAL OR WRITTEN, EXPRESS OR IMPLIED. TO THE MAXIMUM EXTENT PERMITTED BY LAW, KRAMER ELECTRONICS SPECIFICALLY DISCLAIMS ANY AND ALL IMPLIED WARRANTIES, INCLUDING, WITHOUT LIMITATION, WARRANTIES OF MERCHANTABILITY AND FITNESS FOR A PARTICULAR PURPOSE. IF KRAMER ELECTRONICS CANNOT LAWFULLY DISCLAIM OR EXCLUDE IMPLIED WARRANTIES UNDER APPLICABLE LAW, THEN ALL IMPLIED WARRANTIES COVERING THIS PRODUCT, INCLUDING WARRANTIES OF MERCHANTABILITY AND FITNESS FOR A PARTICULAR PURPOSE, SHALL APPLY TO THIS PRODUCT AS PROVIDED UNDER APPLICABLE LAW. IF ANY PRODUCT TO WHICH THIS LIMITED WARRANTY APPLIES IS A "CONSUMER PRODUCT" UNDER THE MAGNUSON-MOSS WARRANTY ACT (15 U.S.C.A. §2301, ET SEQ.) OR OTHER APPLICABLE LAW, THE FOREGOING DISCLAIMER OF IMPLIED WARRANTIES SHALL NOT APPLY TO YOU, AND ALL IMPLIED WARRANTIES ON THIS PRODUCT, INCLUDING WARRANTIES OF MERCHANTABILITY AND FITNESS FOR THE PARTICULAR PURPOSE, SHALL APPLY AS PROVIDED UNDER APPLICABLE LAW.

Other Conditions

This limited warranty gives you specific legal rights, and you may have other rights which vary from country to country or state to state.

This limited warranty is void if (i) the label bearing the serial number of this product has been removed or defaced, (ii) the product is not distributed by Kramer Electronics or (iii) this product is not purchased from an authorized Kramer Electronics reseller. If you are unsure whether a reseller is an authorized Kramer Electronics reseller, visit our web site at www.kramerav.com or contact a Kramer Electronics office from the list at the end of this document.

Your rights under this limited warranty are not diminished if you do not complete and return the product registration form or complete and submit the online product registration form. Kramer Electronics thanks you for purchasing a Kramer Electronics product. We hope it will give you years of satisfaction.



HDMI™
HIGH-DEFINITION MULTIMEDIA INTERFACE



P/N: 2900-301566

Rev: 1



SAFETY WARNING

Disconnect the unit from the power supply before opening and servicing

For the latest information on our products and a list of Kramer distributors, visit our website where updates to this user manual may be found.

We welcome your questions, comments, and feedback.

The terms HDMI, HDMI High-Definition Multimedia Interface, and the HDMI Logo are trademarks or registered trademarks of HDMI Licensing Administrator, Inc. All brand names, product names, and trademarks are the property of their respective owners.