

## CV605-U3 CV605-U3W

5x HD USB-C PTZ Camera with HDMI & IP



## User Manual

Table of Contents

GENERAL INFORMATION 02
1. INSTALLATION 03
1.1 Camera Layout Explanation 03
1.2 Power On Initial Configuration 03
1.3 Video Output 03
2. PRODUCT OVERVIEW 04
2.1 Product Introduction 04
2.1.1 Dimension 04
2.1.2 Accessory 04
2.2 Main Features 05
2.3 Technical Specification 06
2.4 Interface Instruction 08
2.4.1 External Interface 08
3. APPLICATION INSTRUCTION 09
3.1 Remote Controller 09
3.1.1 Keys Instruction 09
3.1.2 Applications 10
3.2 Menu Setting 13
3.2.1 Main Menu 13
3.2.2 System Setting 14
3.2.3 Camera Setting 15
3.2.4 P/T/Z 20
3.2.5 Network Settings 21
3.2.6 Audio Settings 21
3.2.7 Video Format 22
3.2.8 Version 22
3.2.9 Restore Default 23
4. NETWORK CONNECTION 24
4.1 Connecting Mode 24
4.2 IE Log In 25
4.2.1 Web Client 25
4.2.2 Preview 25
4.2.4 Configuration 26
4.2.6 Network Configure 30
4.2.7 System Configure 32
4.2.8 Logout 33
5. SERIAL COMMUNICATION CONTROL 34
5.1.1 Camera Return Command 34
5.1.2 Camera Control Command 35
5.1.3 Inquiry Command 40
6. CAMERA MAINTENANCE AND TROUBLESHOOTING 42
6.1 Camera Maintenance 42
6.2 Troubleshooting 42

1. General Information

This manual details features, functions, installation, operation and recommendation. Please read this manual completely before installation and use.

Description of use

- 1. To prevent damage to this camera or other components within the workflow, please use it within its prescribed purpose and scope of operation.
2. Keep the device away from rain, moisture, or heavy humidity.
3. To prevent electric shock or damage to internal components, do not open the main case; only qualified technicians should conduct repairs.
4. Do not use the device beyond scope of its temperature, humidity, or power supply specification.
5. When cleaning the camera lens, use a soft dry cloth. If dirt is harder to remove, please use water or mild soap. Do not use strong or corrosive detergent, it may scratch the lens and/or cause chemical residue to remain.

Careful handing: Avoid damage from heavy pressure, strong vibration or immersion during transportation, storage and installation.

Power supply polarity: This product uses DC 12V power supply (higher or lower voltage may cause damage or camera not to operate properly).

Install with caution

- 1. Do not carry the camera by the camera head or rotate it with force, otherwise it may cause mechanical malfunction and damage internal belts and gears.
2. This product should be placed on a stable desktop or other horizontal surfaces. Do not install the product on anything other than a level position, otherwise it may display inclined or off axis image.
3. This product shell is made of organic materials. Do not expose it to any liquid, gas or solids which may corrode the shell.
4. During installation, ensure that there are no obstacles within rotation range of the head to limit its movement (Pan/Tilt).
5. Do not power on before installation is complete, as it may be restricted in movement.

Do not disassemble the product without permission from manufacturer: This product does not contain any parts of which can be repaired in field or at site. Any damage arising from disassembly voids the product warranty.

Magnetic field interference: Magnetic field within a specific frequency such as too close to a monitor or television may affect camera video image; this is a Class A product. Some applications within an office or household environment may cause radio interference. Make sure there are no other radio frequencies close by.

## 1. Installation

### 1.1 Camera Layout

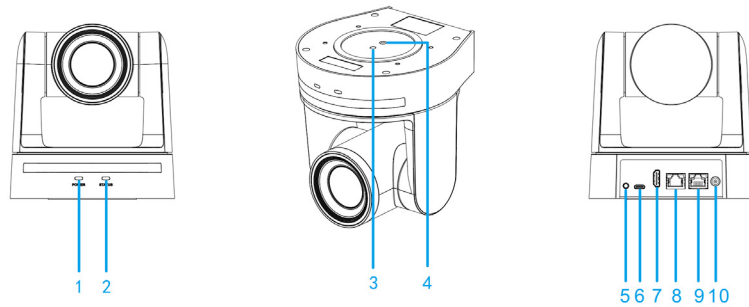

#### Layout Definitions of USB3.0 Type-C Model:

1. Power Indicator	2. Remote Controller Receiver Light
3. Stability Hole Mount	4. 1/4"-20 Mounting Hole
5. Audio Input interface	6. USB3.0 Type-C interface
7. HDMI Port	8. Ethernet Port
9. RS232 Port	10. DC12V Input Power Supply Socket

### 1.2 Power on initial configuration

1. Power on: Connect DC12V power supply included in box to power outlet and camera power input.
2. Initial configuration: Once powered up the power indicator light will start blinking, camera head will move from bottom left then moves to the HOME position (horizontal and vertical center), while the camera module boots up. As soon as remote-control receiver light stops blinking, the self-check and boot up is complete.

#### Note:

- The default address of the IR remote is Camera #1 address.
- If you set preset to "0" then after self-check and boot-up, the camera will then automatically move to the preset "0" position that you've chosen as start position.

### 1.3 Video Output

1. Network output:
  - A. Network Cable Connection Port: No.8 in Figure 1.1
  - B. Webpage Login: : Open web browser and enter default IP address 192.168.5.163 in the address bar (factory default); press Enter and enter the LOGIN prompt. Then click on default user name admin and password admin (factory default); then press Enter to see preview page. Users can carry out PTZ control commands, playback, configuration and other operations from this software GUI.

2. USB3.0 Type-C output: Use the included USB cable to connect camera to computer USB3.0 port, then run whichever video capture software chosen on computer and select the camera to display image.
3. HDMI output: Use HDMI cable to connect camera to a monitor or switching equipment, then the monitor or other processing equipment will display image.

## 2. Product Overview

### 2.1 Product Introduction

#### 2.1.1 Camera Dimensions

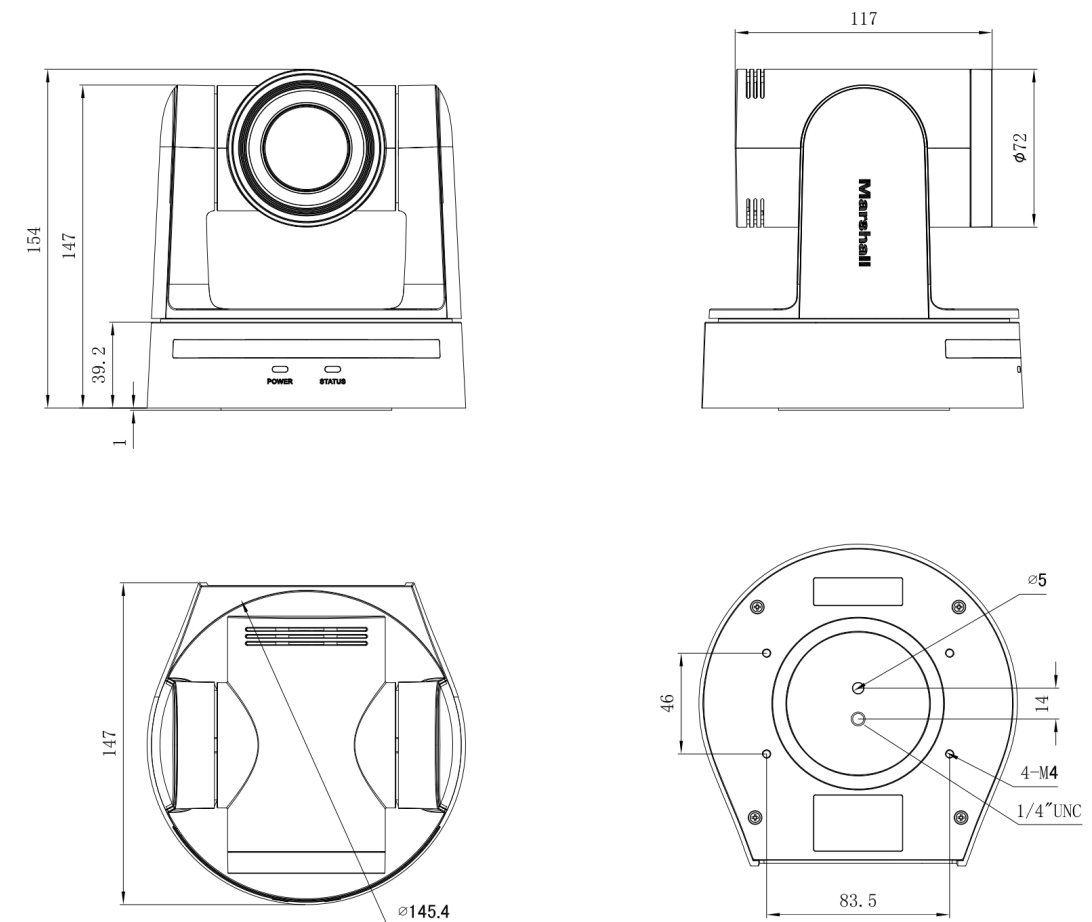

#### 2.1.2 Accessory

During unboxing of camera packaging, please check that all the supplied accessories are included:

##### Accessories:

- Power adapter
- IR Remote
- USB3.0 Type-C Cable
- Thank You Card
- Warranty card

##### Optional Accessories (sold separately):

- CV605-WM (Wall Mount-Black)
- CV605-WMW (Wall Mount-White)
- CV605-CM Ceiling Mount (one color)

## 2.2 Main Features

The CV605 camera series offers high quality performance with rich feature sets. The features include advanced ISP processing algorithms to provide vivid images with deep color depth, and accurate color reproduction. CV605 models support H.264 and H.265 encoding which creates smooth video performance and clear images under less-than-ideal bandwidth conditions. CV605-BK/WH also contain 3GSDI outputs, and CV605-U3/U3W also contain USB-C and HDMI outputs.

1. **True High-definition Image:** Built around a 1/2.8-inch high quality CMOS sensor. Capability of up to 1920x1080p at frame rates up to 60 fps.
2. **Optical Zoom Lens:** 5X zoom lens with 84° AOV (wide viewing angle) without distortion.
3. **Leading Auto Focus Technology:** Cutting edge Auto Focus algorithm makes fast, accurate and stable auto-focus.
4. **Low Noise and High SNR:** Low Noise CMOS effectively ensure high SNR of camera video. Advanced 2D/3D noise reduction technology is also used to further reduce noise, while ensuring image sharpness.
5. **Quiet PTZ:** By designing high accuracy step motor technology, camera movement is extremely quiet with smooth maneuvers and fast accurate destinations (presets).
6. **Video Outputs:** Support USB3.0 type-C, HDMI and IP (LAN) interfaces
7. **Multiple Video compression:** Support H.264/MJPEG/YUY2/NV12 video compression
8. **Audio Input Interface:** Support 16000, 32000, 48000 sampling frequency and AAC, MP3, G.711A audio coding.
9. **Multiple Network Protocol:** Support ONVIF, RTSP, RTMP protocols
10. **Low-power sleep function:** Support ultra-low power consumption while in sleep mode (less than 400mW)
11. **Multiple Control Protocols:** Support VISCA, Pelco-D, Pelco-P and support auto-recognize protocol discovery.
12. **255 Presets Positions:** Up to 255 presets (10 presets available on IR remote controller)

## 2.3 Technical Specification

Model	CV605-U3, CV605-U3W
<b>Camera Parameter</b>	
Optical Zoom	5X, f=3.1~15.5mm
Sensor	1/2.8-inch HD CMOS sensor
Effective Pixels	16:9, 2.07 megapixel
Video Format	<b>USB:</b> YUY2, NV12: 640x480/320x180/480x270/640x360/800x448/800x600/1024x576/ 1280x720/1920x1080  <b>MJPEG, H.264:</b> 640x480/320x240/352x288/480x270/640x360/720x480/720x576/ 800x448/800x600/960x540/1024x576/1280x720/1600x896/1920x1080  <b>HDMI:</b> 1920x1080p @ 60/59.94/50/30/29.97/25fps 1280x720p 60/59.94/50fps
Viewing Angle	20°(tele)--84°(wide)
Digital Zoom	10X additional
Minimum Illumination	0.5Lux (F1.8, AGC ON)
DNR	2D & 3D DNR
White Balance	Auto / Manual/ One Push/ VAR
Focus	Auto/Manual/One Push
Iris	Close/F11/9.6/8.0/6.8/5.6/4.8/4.0/3.4/2.8/2.4/2.0/1.8
Electronic Shutter	Auto/Manual
BLC	ON/OFF
Video Adjustment	Brightness, Color, Saturation, Contrast, Sharpness,
B/W mode, Gamma curve	
SNR	>55dB
<b>Input/ Output Interface</b>	
Video Interfaces	USB3.0 Type-C, HDMI, IP (LAN)
Video Compression Format	H.264, YUV2, NV12, MJPEG
Audio Input Interface	Two-channel 3.5mm (Line or Mic level)
Audio Output	USB3.0, HDMI, IP (LAN) output together with video
Audio Compression Format	AAC/MP3/G.711A
IP Interface	100M IP port(100BASE-TX)
Network Protocol	RTSP/RTMP, ONVIF; supports Visca over IP control protocols
Control Interface	RS232
Control Protocol	VISCA/Pelco-D/Pelco-P; Baud Rate: 115200/38400/9600/4800/2400



Power Interface	HEC3800 outlet (DC12V)
Supply Adapter	AC110V-AC220V to DC12V/1.5A
Input Voltage	DC12V±10%
Input Current	1A (Max)
Consumption	12W (Max)
<b>PTZ Parameter</b>	
Pan Rotation	-170° ~ + 170°
Tilt Rotation	-90°~+90°
Pan Control Speed	0.1 -60°/sec
Tilt Control Speed	0.1-30°/sec
Preset Speed	Pan: 60°/sec, Tilt: 30°/sec
Preset Number	255 presets (10 presets by remote controller)
<b>Other Parameter</b>	
Store Temperature	-10°C+60°C
Store Humidity	20% - 95%
Working Temperature	-10°C+50°C
Working Humidity	20% - 80%
Dimension	145.4mm x 147mm x 154mm
Weight	1.27 KG
Using Environment	Indoor
Accessories Included	Power Supply, IR Remote, USB3.0 Type-C cable, Thank You Card
Accessories (sold separately)	CV605-WM (Black) Wall Mount, CV605-WMW (White) Wall Mount, CV605-CM (Universal) Ceiling Mount

## 2.4 Interface Instruction

### 2.4.1 External Interface

External interfaces: Audio Input, USB3.0 Type-C, HDMI, (IP) Ethernet, RS232 input, DC12V Power

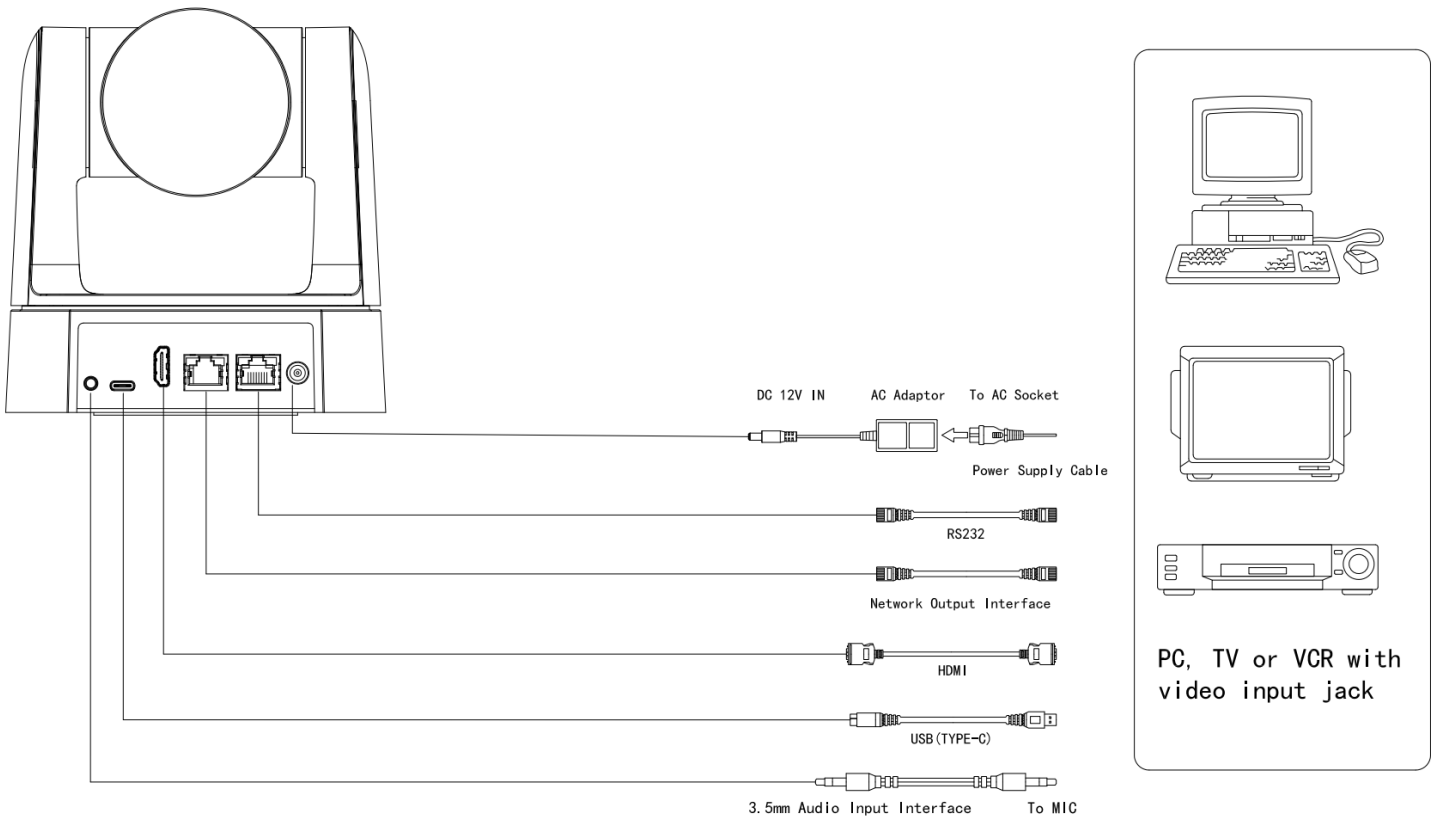

## 3. Application Instruction

### 3.1 IR Remote Controller

#### 3.1.1 Keys Instruction

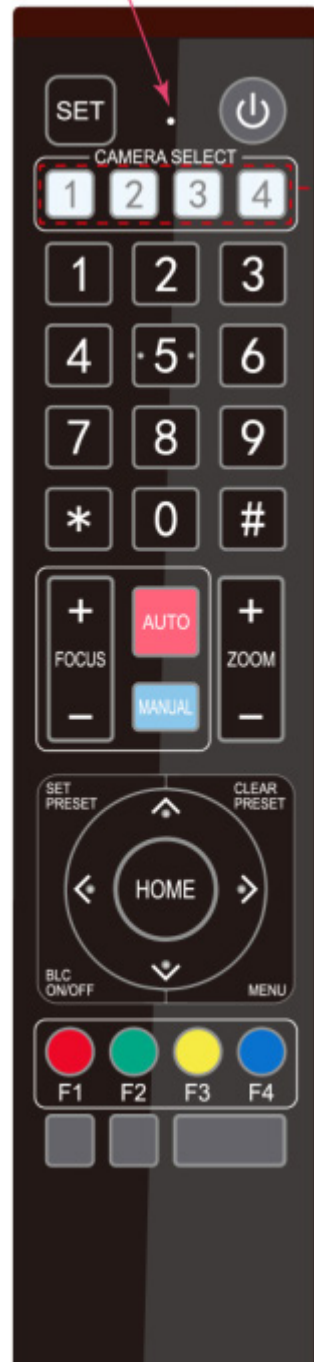

- 1. Standby Key**  
 After 3 second press, the camera will step into standby mode. Another 3 second press again, camera will self-test again and go back to HOME position. Note: If power-on mode is turned on and the Preset 0 position is set, and there is no operation within 12 seconds it will automatically point camera to the specified "0" preset position.
- 2. CAMERA SELECT Address Selection**  
 Select the camera address which wants to be controlled
- 3. Number Keys**  
 Set or call-up 0-9 camera presets
- 4. \*, # Key**  
 Key combination use
- 5. Focus Control Key**  
 Auto Focus: Enter Auto focus mode.  
 Manual Focus: Enter Manual focus mode  
 While in Manual focus use [focus +] or [focus -] to adjust focus of image.
- 6. Zoom Control Key**  
 Zoom+ : Lens moves near  
 Zoom - : Lens moves far
- 7. Set or Clear Preset key:**  
 SET PRESET: Set preset key + 0-9 number key sets that saved position  
 CLEAR PRESET: Clear preset key + 0-9 number key removes the saved position
- 8. Pan/Tilt Control Key**  
 Press ▲ Key: Up  
 Press ▼ Key: Down  
 Press ◀ Key: Left  
 Press ▶ Key: Right  
 "HOME" Key: Return to the middle position or enter the next menu level
- 9. BLC Control Key**  
 Back Light ON / OFF: Turn on or off the back light
- 10. Menu Setting**  
 Open or close the OSD menu  
 Enter / exit the OSD menu or return to the previous menu.

#### 11. Camera IR Remote Control Address Setting

- [ \* ] + [ # ] + [ F1 ]: Camera Address No.1
- [ \* ] + [ # ] + [ F2 ]: Camera Address No. 2
- [ \* ] + [ # ] + [ F3 ]: Camera Address No. 3
- [ \* ] + [ # ] + [ F4 ]: Camera Address No. 4

#### 12. Key Combination Functions

- 1) [ # ] + [ # ] + [ # ]: Clear all presets
- 2) [ \* ] + [ # ] + [ 6 ]: Restore factory defaults
- 3) [ \* ] + [ # ] + [ 9 ]: Flip switch
- 4) [ \* ] + [ # ] + Auto: Enter into the aging mode
- 5) [ \* ] + [ # ] + [ 3 ]: Menu set to Chinese
- 6) [ \* ] + [ # ] + [ 4 ]: Menu set to English
- 7) [ \* ] + [ # ] + Manual: Restore the default user name, password, and IP address
- 8) [ # ] + [ # ] + [ 0 ]: Switch the video format to 1080P60
- 9) [ # ] + [ # ] + [ 1 ]: Switch the video format to 1080P50
- 10) [ # ] + [ # ] + [ 2 ]: Switch the video format to 1080P30
- 11) [ # ] + [ # ] + [ 3 ]: Switch the video format to 1080P25
- 12) [ # ] + [ # ] + [ 4 ]: Switch the video format to 720P60
- 13) [ # ] + [ # ] + [ 5 ]: Switch the video format to 720P50
- 14) [ # ] + [ # ] + [ 6 ]: Switch the video format to 1080P59.97
- 15) [ # ] + [ # ] + [ 7 ]: Switch the video format to 1080P29.97
- 16) [ # ] + [ # ] + [ 8 ]: Switch the video format to 720P59.97

#### 3.1.2 Applications

After initialization, camera can receive and execute IR remote commands. Press the remote controller power button, the indicator light starts flashing; release the button, the indicator light stops flashing. Users can then control the pan/tilt/zoom, adjust settings and set/callup preset positions with IR remote.

Key Instruction:

1. In this instruction, "press the key" means a click rather than a long-press, and a special note will be given if a long-press for more than one second is required.
2. When a key-combination is required, do it in sequence. For example, "[ \* ] + [ # ] + [ F1 ]" means press "[ \* ]" first and then press "[ # ]" and last press "[ F1 ]".

### 1) Camera Selection



Select the camera address to control.

### 2) Pan/Tilt Control



Up: press ▲ Down: press ▼

Left: press ◀ Right: press ▶

Back to middle position: press "[HOME]"

Press and hold the up/down/left/right key, the pan/tilt will keep moving, from slow to fast, until it runs to the endpoint; the pan/tilt operation stops as soon as the key is released.

### 3) Zoom Control

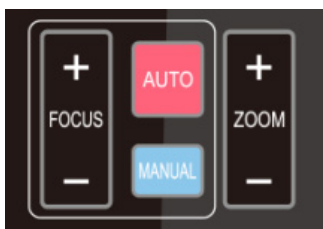

ZOOM IN: press "ZOOM ▲" key

ZOOM OUT: press "ZOOM ▼" key

Press and hold the key, the camera will keep zooming in or out and stops as soon as the key is released.

### 4) Focus Control

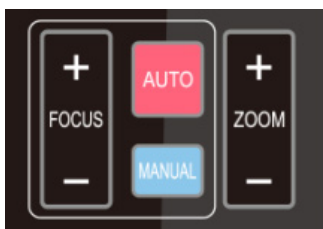

Focus (near): Press [focus+] key works in manual focus mode

Focus (far): Press [focus-] key works in manual focus mode

Auto Focus: Support

Manual Focus: Support

Press and hold the key, action will continue and stops as soon as the key is released.

### 5) BLC Setting



BLC ON / OFF: support

### 6) Presets Setting, Running, Clearing



1. Preset setting: to set a preset position, the users should press the [SET PRESET] key first and then press the number key 0-9 to set a relative preset.

**Note: 10 preset positions in total are available by remote controller, 255 preset positions in total from RS232 (Pelco)**

2. Preset Running: Press a number key 0-9 directly to move to a relative preset.

**Note: camera will only move if that preset has been set.**

3. Preset clearing: to clear a preset position, the user can press the [CLEAR PRESET] key first and then press the number key 0-9 to clear the relative preset;

**Note: press the [ # ] key three times to cancel all the presets previously saved.**



### 7) Camera Remote Controller Address Setting



[ \* ] + [ # ] + [ F1 ]: Camera Address No.1

[ \* ] + [ # ] + [ F2 ]: Camera Address No. 2

[ \* ] + [ # ] + [ F3 ]: Camera Address No. 3

[ \* ] + [ # ] + [ F4 ]: Camera Address No. 4

## 3.2 MENU SETTING

### 3.2.1 Main Menu

In normal working mode, press [MENU] key to display the OSD main menu. Use up/down arrows to navigate the menu and press [HOME] as an ENTER button within the menu.

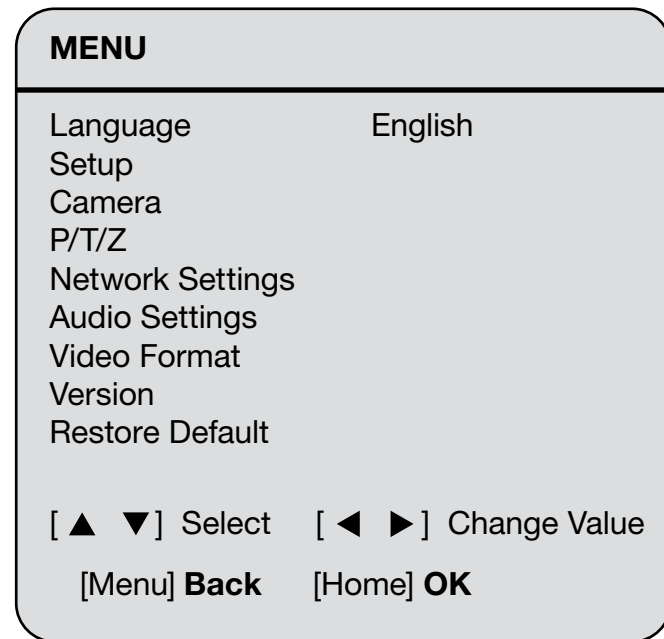

**LANGUAGE:** Language setting, English / Chinese

**SETUP:** System settings

**CAMERA:** Camera settings

**PTZ:** Pan tilt zoom settings

**Network Settings:** turn DHCP mode on/off and check camera IP address

**Audio Settings:** turn on/off the audio and adjust the volume

**Video Format:** select video output formats

**VERSION:** display camera firmware version

**Restore Default:** Reset settings

**[▲ ▼] Select:** for selecting menu

**[◀ ▶] Change Value:** for modify parameters

**[MENU] Back:** Press [MENU] to return

**[Home] OK:** Press [Home] to confirm

### 3.2.2 System Setting

Move the pointer to (Setup) in the Main Menu, click the [HOME] key and enter into Setup menu as below.

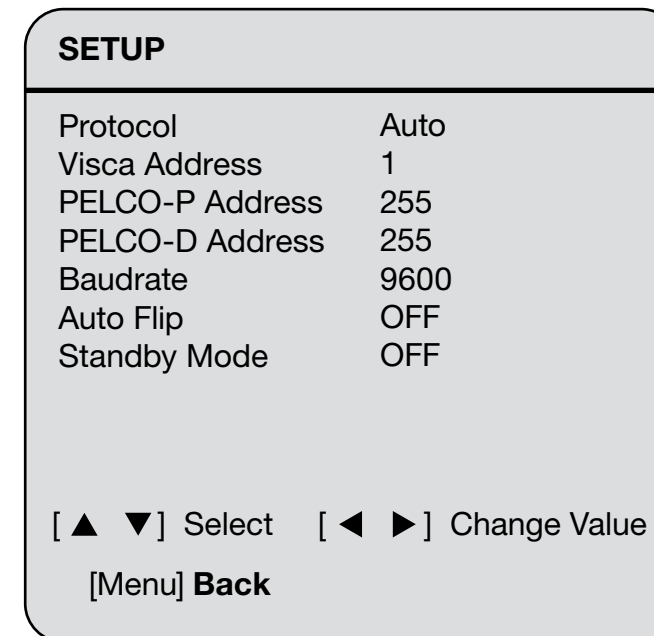

**PROTOCOL:** VISCA/Pelco-P/Pelco-D/Auto

**Visca Address:** 1 ~ 7

**PELCO-P Address:** 1 ~ 255

**PELCO-D Address:** 1 ~ 255

**Baud rate:** 2400/4800/9600/38400/115200

**Auto Flip:** ON/OFF (When it's ON, image will automatically flip if camera is mounted upside down)

**Standby Mode ON:** When camera is not selected or disabled from video software, the camera lens will go to face down position (which is standby mode). When camera is selected again, camera will be triggered by UVC command from video software and lens will return to the last position. Standby Mode OFF: When camera is not selected or disabled from video software, the lens will stay in current position (just no image is captured). When camera is selected again, camera will capture image again.



### 3.2.3 Camera Setting

Move the pointer to (Camera) in the Main Menu, click the [HOME] key and enter into Camera menu as below.

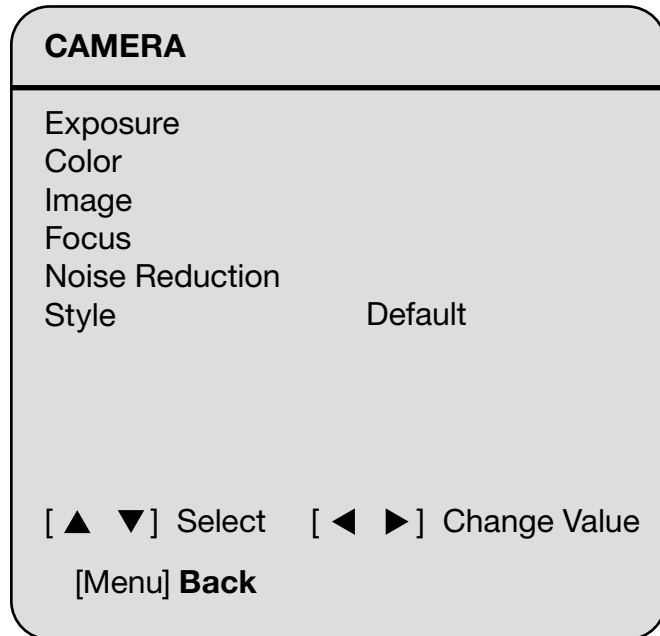

**EXPOSURE:** Enter into Exposure settings

**COLOR:** Enter into color settings

**IMAGE:** Enter into image settings

**FOCUS:** Enter into focus settings

**Noise Reduction:** Enter into noise reduction

**Style:** choose picture style options (Default/Normal/Clarity/Bright/Soft)

### 1) EXPOSURE

Move the pointer to the (Exposure) menu, click the [HOME] key to enter into Exposure menu as follow,

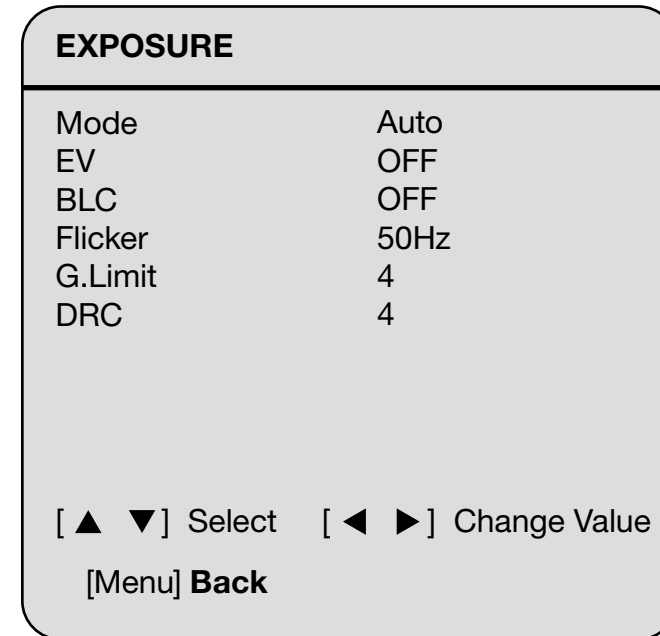

**Mode:** Auto, Manual, Shutter priority, Iris priority and Bright

**EV:** On/Off (only available in Auto mode)

**EV Level:** -7~7 (only available in Auto mode when EV is ON)

**BLC:** ON/OFF (only available in Auto mode)

**Flicker:** OFF/50Hz/60Hz for options (available in Auto/Iris priority/Bright modes)

**Gain Limit:** 0~15(available in Auto/ Iris priority /Bright modes)

**Gain:** 0 ~ 15 (available in Manual and Shutter priority modes)

**DRC:** Close, values 1~8

**Shutter Priority:**

1/25,1/30,1/50,1/60,1/90,1/100,1/120,1/180,1/250,1/350,1/500,1/1000,1/2000,1/3000,1/4000,1/6000,1/10000 (available in Manual and Shutter priority mode)

**IRIS Priority:** Close, F11, F9.6, F8.0, F6.8, F5.6, F4.8, F4.0, F3.4, F2.8, F2.4, F2.0, F1.8 (only available in Manual and Iris priority mode)

**Bright:** 0~23 (only available in Bright mode)

## 2) COLOR

Move the pointer to the (Color) menu, click the [HOME] key to enter into Color menu as follow,

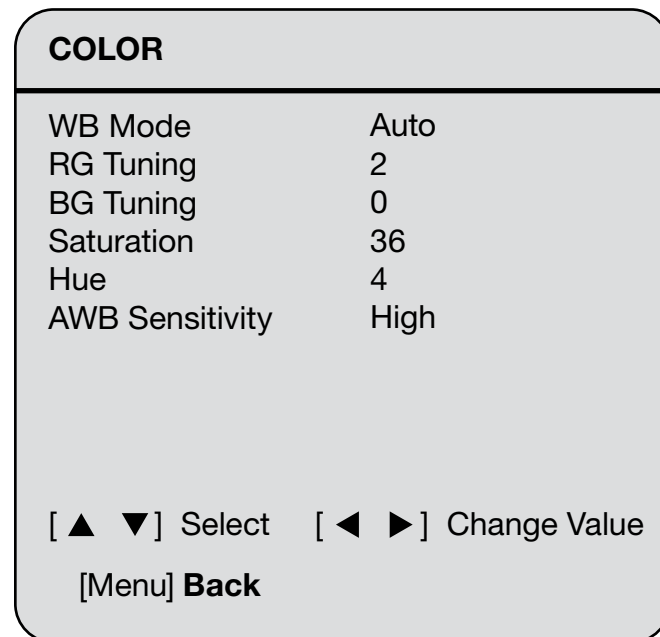

**WB Mode:** Auto, Manual, One Push, VAR

**RG Tuning:** -10 ~ 10 (only available in Auto mode)

**BG Tuning:** -10 ~ 10 (only available in Auto mode)

**Color Temp:** 2400K ~ 7100K (only available in VAR mode)

**Red Gain:** 0~100 (only available in Manual mode)

**Blue Gain:** 0~100 (only available in Manual mode)

**Saturation:** 0 ~ 127

**Hue:**0-8

**AWB Sensitivity:** High/Middle/Low (only available in Auto mode)

## 3) IMAGE

Move the pointer to the (Image) menu, click the [HOME] key to enter into Image menu as follow,

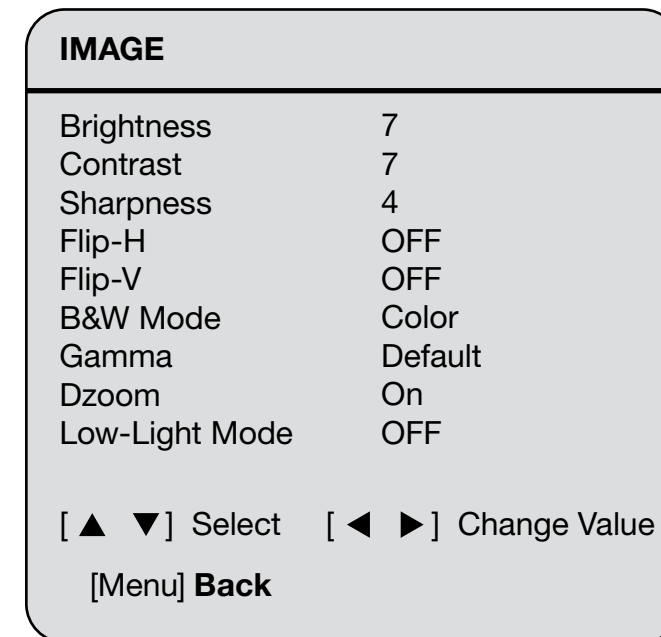

**Brightness:** 0 ~ 14

**Contrast:** 0 ~ 14

**Sharpness:** 0~15

**Flip-H:** On/Off (When Auto Flip is ON, this option will be disabled)

**Flip-V:** On/Off (When Auto Flip is ON, this option will be disabled)

**B&W Mode:** Color, B&W

**Gamma:** **Default**, 0.45, 0.50, 0.55, 0.63

**DZoom:** ON/OFF

**Low-Light Mode:** OFF

## 4) FOCUS

Move the pointer to the (Focus) menu, click the [HOME] key to enter into Color menu as follow,

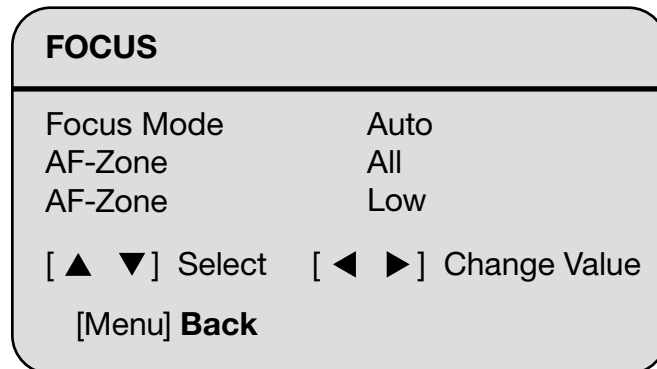

**Focus Mode:** Auto, Manual, OnePush

**AF-Zone:** All, Top, Center, Bottom

**AF-Sensitivity:** High, Middle, Low

## 5) NOISE REDUCTION

Move the pointer to the (Noise Reduction) menu, click the [HOME] key to enter into Noise Reduction menu as follow,

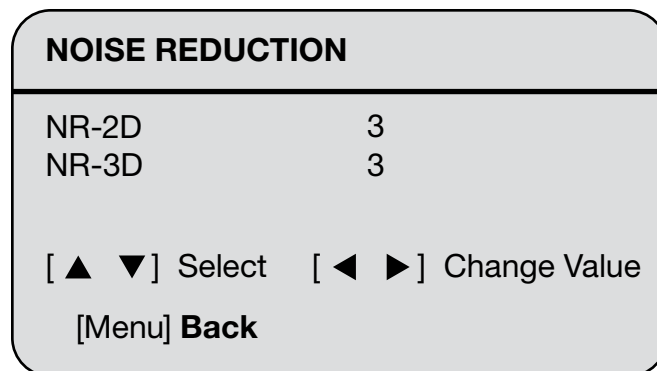

**2D Noise Reduction:** Auto, OFF, 1~7

**3D Noise Reduction:** OFF, 1~8

## 3.2.4 P/T/Z

Move the pointer to the (P/T/Z) in the Main Menu, click the [HOME] key to enter into P/T/Z menu as follow,

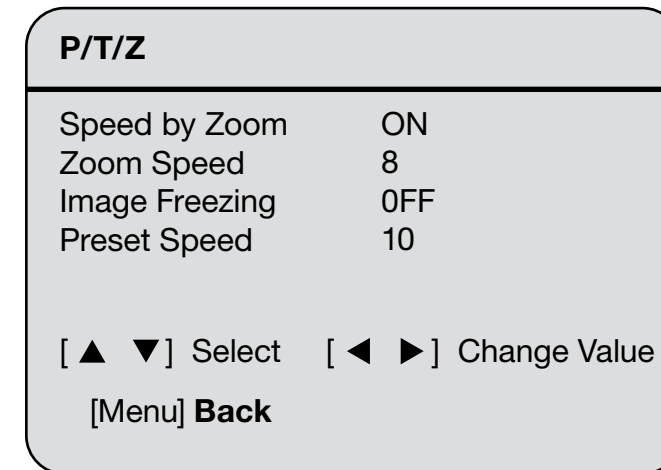

**Speed by Zoom:** ON/ Off (Only effective for IR remote controller). When this option is ON, Pan/Tilt moving speed will adjust slower when the image is zoomed in to adapt to intensity of movement.

**Zoom Speed:** 1~8 (Only effective for IR remote controller)

**Image Freezing:** On/Off (Only effective for HDMI and LAN outputs)

**Preset speed:** 1-10

### 3.2.5 Network settings

Move the pointer to the (Network Settings) in the Main Menu, click the [HOME] key to enter into network settings menu as follow

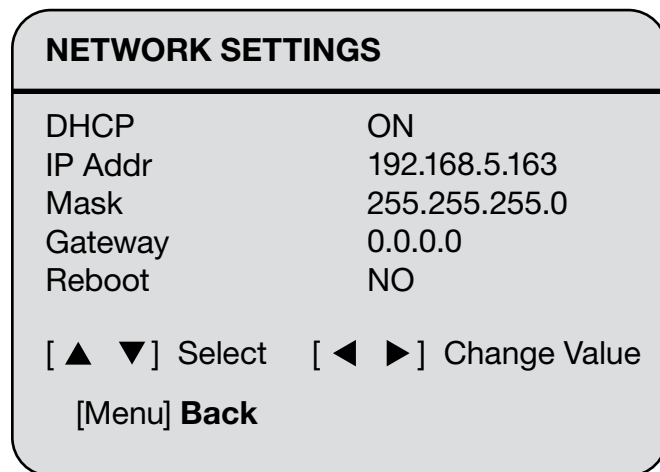

**Note:** Make sure to connect the Ethernet (CAT) cable from IP switch to CV605 camera Ethernet port. Make the change to DHCP from ON to OFF, or OFF to ON, then go down to Reboot option, use the right arrow button from IR remote controller to choose “YES” and press “HOME” button to confirm, then camera will reboot. After reboot,

the actual IP address will take effect and display in network settings menu.

### 3.2.6 Audio settings

Move the pointer to the (Audio Settings) in the Main Menu, click the HOME key to enter into audio settings menu as follow,

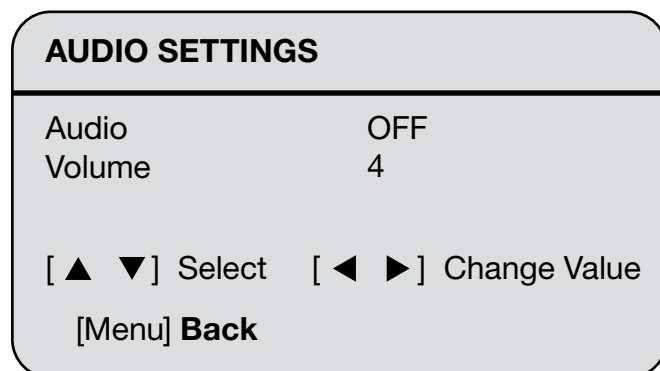

**Note:** This setting is used for 3.5mm audio input interface (both line and Mic levels).

### 3.2.7 Video Format

Move the pointer to the (Video Format) in the main Menu, click the [HOME] key to enter into video format menu as follow,

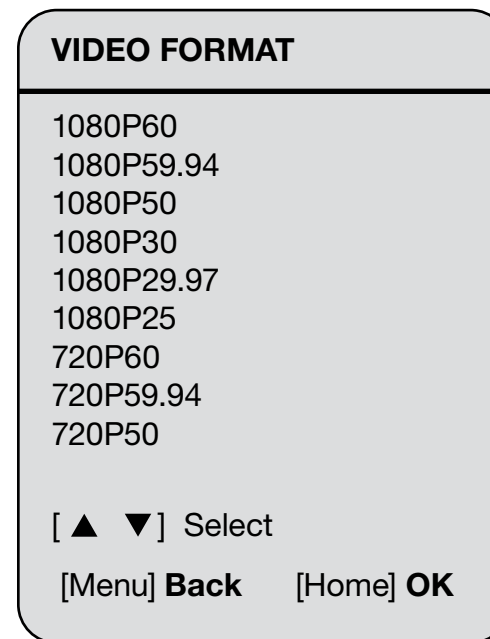

### 3.2.8 Version

Move the pointer to the (Version) in the Main Menu, click the [HOME] key to enter into version menu as follow,

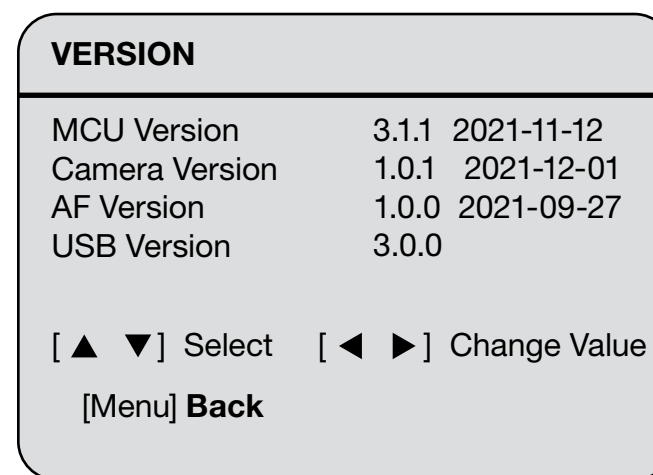

**MCU Version:** Display MCU version information

**Camera Version:** Display camera version information

**AF Version:** Display the focus version information

**USB Version:** Display USB version information



3.2.9 Restore Default

Move the pointer to the (Restore Default) in the Main Menu, click the [HOME] key to enter the restore default menu as follow,

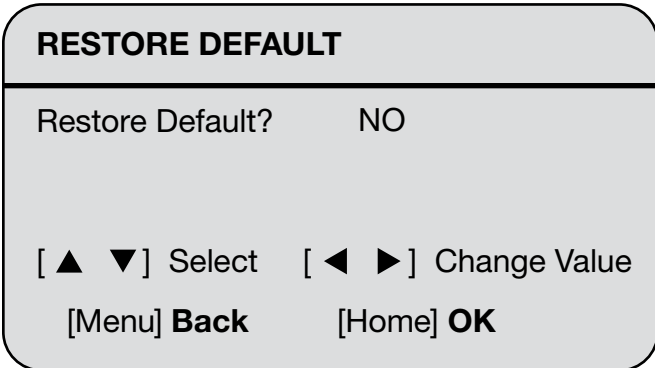

Restore Default: options: yes/no

After restoring defaults, the video format restores to default. Settings not restored are VISCA address, baud rate and IP address as to not lose control of camera.

4. Network Connection

4.1 Connecting Mode

Direct connection: Connect the camera directly to a computer or laptop by Ethernet cable.

Internet connection (DHCP): Connect the camera to Internet by Router or Switch and user can log in the device by browser. Marshall strongly recommends NETGEAR switches as highly reliable and fully supported.

Note: Please do not install power and/or network cables in places where they can be easily touched or moved to prevent interruption of AV performance.

Direct connection (Using Default IP): The computer must have the network segment where the camera IP address belongs to. The device will not be accessible if without the segment. I.E. The camera default IP address is 192.168.5.163, then segment 5 must be added in the computer. Specific steps are as below:

First open operation software window Local Area Connection Properties on computer, select the "Internet Protocol Version 4(TCP/IPv4)" as shown below. Double click "Internet Protocol Version 4(TCP/IPv4)" or click "Properties" to enter into the Internet Protocol Version 4(TCP/IPv4) Properties window. Under "General" tap, select "User the following IP address". Enter the static IP "192.168.5.26" which has the same network segment as camera default IP address and subnet mask "255.255.255.0" as picture below. Click "OK" to finish.

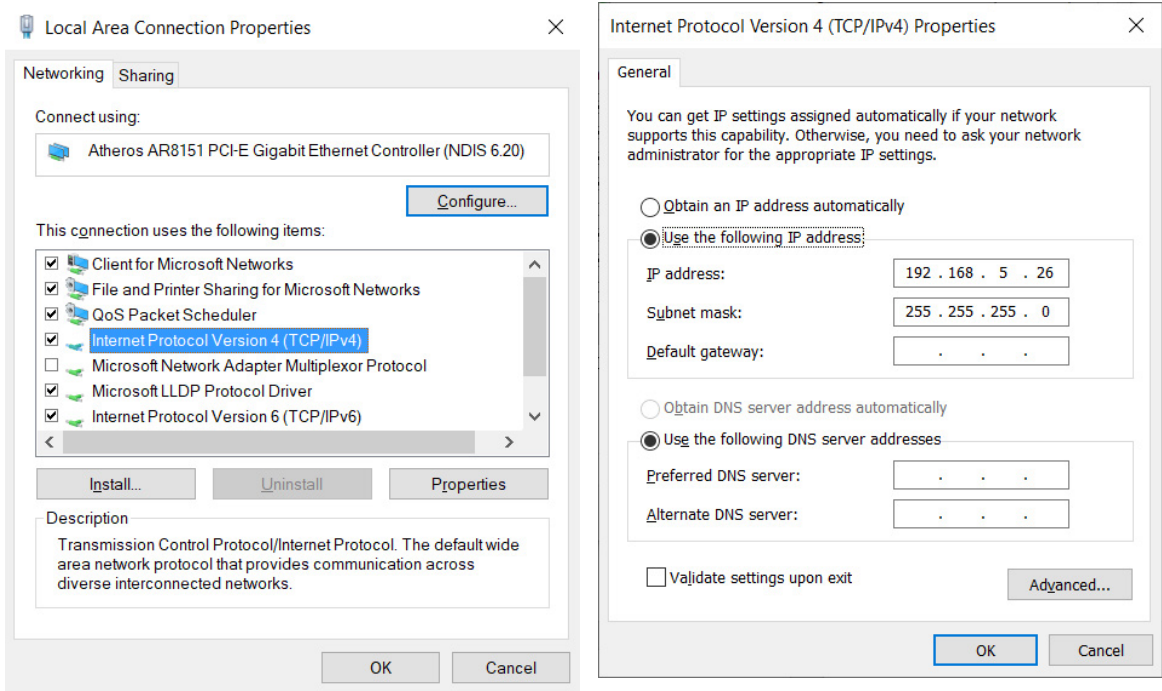

### Internet connection (Using DHCP):

To use DHCP, first turn on DHCP in Network Settings OSD menu on camera. Power cycle the camera so the assigned IP address from network switch gets assigned to the camera. Check the assigned IP address in Network Setting OSD menu again and use the address to log into camera webpage. Please make sure computer and camera are connected to the same network and “Obtain an IP address automatically” needs to be selected in computer’s “Internet Protocol Version 4 (TCP/IPv4) Properties window.

## 4.2 IE Log In

### 4.2.1 Web client

#### 1) Web client Log In

Input the IP address 192.168.5.163 of the device in web browser and click Enter button to enter into Web Client login page as below picture. User can login as administrator and normal user. If login as Administrator (Default User name/Password: admin), users can preview, configuration and logout in the Web Client; If login in Normal User (Default User name/Password:user1 or user2), users can only preview, and logout, no option for configuration.

### 4.2.2 Preview

After successful login into the management interface, video management software enters the video preview interface. In the preview screen, users can control PTZ, zoom, focus, video capture, sound, focus, full screen and set the preset position, run, delete and other operations.

#### 1) Login as administrator

User name and password are both admin by default;

PTZ control can be carried out, zoom, focus, audio, full screen and set the preset position, run, and delete; you can preview, configuration and logout.

#### 2) Login as normal user

Default User name/password: user1 or user2

PTZ control can be carried out, zoom, focus, audio, zoom, full screen and set the preset position, run, and delete; you can preview and log off.

NOTE: There is no configuration right for normal user login.

### 4.2.4 Configuration

Click Configuration to enter the device parameters setting page

There are the following options: Audio Configure, Video Configure, Network Configure, System Configure, please see the following table about detailed description

Menu	Explanation
Audio Configure	Including encode type, sample rate, sample bits, bit rate, channel and input volume
Video Configure	Including video encode, stream publish, RTMP multicast, video OSD, OSD font size, video out
Network Configure	Including network port, Ethernet, DNS, GB28181 and RTSP
System Configure	Including SysAttr, system, sysuser, update, default and reboot

#### 1) Audio Configuration

**Enable:** Choose to enable the audio or not.

**Encode Type:** Set audio compressing format and the device will reboot automatically after change (default AAC, MP3, AAC optional)

**Sampling Rate:** Set sampling frequency and the device will reboot automatically after change (default 48000,16000 and 32000)

**Sampling Bits:** Set sampling precision (default 16bits)

**Bit Rate:** Set audio compressing code rate (default 64bits,32,48,96,128bits optional)

**Channel:** Set channel types (Default mono channel, Stereo audio optional)

**Input Audio volume:** Set the volume of input volume (Default 4, 1~10 optional)

Click “SAVE”, it will remind that Success! Needs to Restart the device to enable the audio, then please reboot the camera to make new setting effect.

## 2) Video configuration

### Video Encode

**Stream:** Different video output mode setting, use different streams. (Main stream, Sub stream)

**Compression Format:** Set the video compression format, save and reboot to take it effect (primary / secondary stream default: H.264, H.265 optional)

**Image Size:** Set video image resolution, save and reboot to take it effect (main stream default 1920 \* 1080, 1280 \* 720 and 640\*480 are optional; default Sub stream 320 \* 180, 320\*240, 640\*360, 640\*480, 1280\*720,1920 \* 1080 are optional)

**Rate control:** Set rate control mode, save and reboot to take it effect (Primary / secondary stream default variable bit rate, fixed rate is for option).

**Image Quality:** Set the image quality, image quality can be changed only when rate control is variable bit rate, (main stream defaulted is better, secondary stream default is not good, there are best, better, good, bad, worse, worst for options).

**Bit Rate (Kb/s):** Set the video bit rate (main stream default 4096Kb / s,64-12288Kb / s optional; secondary stream default 1024Kb / s,64-10240Kb / s optional).

**Frame Rate (F/S):** Set the video frame rate (primary / secondary stream default 25F / S, primary stream 5-60F/S optional, secondary stream 5-30F / S optional).

**I frame interval:** Set the key frame interval (primary / secondary stream default 75F, primary / stream 1-300F optional. secondary stream 1-150F optional).

**I Frame Minimum QP:** set key framing minimum QP (default 10,10-51 optional)

**Stream Key:** When receiving rtsp or rtmp stream, the user can modify the stream name; the main stream (default live / av0), secondary stream (default live / av1)

**Note:** Usually reserve LIVE, but only modify the latter part.

Click the “Save” button to display the “saved successfully” message, then settings take effect.

### Stream Publish:

**Enable:** To turn on/off the main / secondary stream.

**Protocol Type:** primary / secondary stream applies RTMP protocol.

**Host Port:** server port number (default 1935,0-65535 optional)

**URL:** server IP addresses (default 192.168.5.11)

**Stream Key:** choose a different stream name (live / av0, live/ av1 optional).

**Username:** Set the user name.

**Password:** Set the password.

Click on the “Save” button to display the “Save successful” message, then settings take effect.

Method of obtaining RTSP: rtsp:// device IP address: 554 / live / av0 (av0 main stream; av1 secondary stream)

### RTP Multicast:

**Main/Sub code stream:** can select by ON/OFF

**Protocol Type:** can choose multicast protocol (default RTP, TS optional)

**Multicast Address:** can set multicast address, default 224.1.2.3

**Multicast Port:** can set multicast port (default main code stream port is 4000, default secondary code stream port is 4002,)

**Access Method:** Fill in or select the information as above to create the visiting address: such as rtp://224.1.2.3:4000; udp://@224.1.2.3:4000;

### Video Parameters:

#### A. Focus: Focus mode, focus range, focus sensitivity can be set.

**Focus Mode:** set the focus mode (the default auto, manual optional)

**Focus range:** set the focus range (the default middle, the upper and lower optional)

**AF-Sensitivity:** Set the focus sensitivity (default is low, high, medium optional)

#### B. Exposure:

**Mode:** Set the exposure mode (the default Atuo, manual, SAE, AAT, Bright optional)

**EV:** Set the exposure compensation value, valid when it is set for auto (default 0,-7 to 7 optional).

**BLC:** Set back light compensation, valid when it is auto status (default is off).

**Anti-flicker:** Set up anti-flicker mode, valid when status of automatic, aperture or brightness priority (default 50Hz, closed,60Hz optional).

**Gain limit:** set the gain limits, auto, active when it is status of aperture or brightness priority(default 3, 0-15 optional).

**Dynamic range:** set the dynamic range (default 4,1-8 optional).

#### C. Color: White balance, saturation, color, white balance, sensitivity, color temperature, gain red and blue gain can be set.

**White balance modes:** Set the white balance mode (the default automatic, manual, One-push, VAR optional).

**Saturation:** Set the saturation (default 80%,60%,70%,80%,90%,100%,110%,120%,130%, optional).

**Auto white balance Sensitivity:** Sensitivity Auto white balance settings (default is low, high, medium optional).

**Chroma:** Set the chrome (default 7,0-14 optional).

**Color Temperature:** set color temperature (Default setting: High, with low, middle for options)

**Red Gain:** Set the red gain, effective when it is manual (default 255,0-255 optional).

**Blue Gain:** Sets the Blue gain, effective when it is manual (default 199,0-255 optional).

**D. Image: Brightness, contrast, sharpness, black and white mode, the gamma curve, Horizontal Flip and Vertical Flip can be set.**

**Brightness:** Set the brightness (default 6,0-14 optional).

**Contrast:** set the contrast (default 8,0-14 optional).

**Sharpness:** Set the sharpness value (default 7, 0-15 optional).

**Black and white mode:** Set black and white mode (default color, black/white optional).

**Gamma:** Gamma value setting (default,0.45,0.50,0.52,0.55 optional).

**Flip Horizontal:** Set Flip Horizontal (default Off, On optional).

**Flip Vertical:** Set vertical flip (default Off, On optional).

**E. Noise Reduction:**

**2D noise reduction, 3D noise reduction and dynamic dead pixel correction available.**

**2D Noise Reduction:** Set 2D noise reduction level (default Auto,1-7 and Off optional).

**3D Noise Reduction:** Set 3D noise reduction level (default 5,1-8 and Off optional).

**Dynamic dead pixel correction:** Set Dynamic dead pixel correction (default Off,1-8 optional).

**Note:** Click “Refresh” to make revision of any video parameters of a, b, c, d, e effective.

**3) Video OSD**

**Show Time:** Set whether to display the time and date (default display).

**Show Title:** Set whether to display the title (default display).

**Font Color of Time:** Set font color of time and date (default white, black, yellow, red, blue optional).

**Font Color of Title:** Set font color of title (default white, black, yellow, red, blue optional).

**Moving characters:** Set the display position of moving date, time and title, click on the “up, down, left, right” buttons to move the corresponding character position.

**Title Content:** Set title content (default CAMERA1).

**Time Content:** Set time content (default 1970/01/10 05:36:00)

Click on the “Save” button and display the “Save successful” message, then valid

**4) OSD Font Size**

**Auto zoom in/out according to the resolution.**

**Master stream font size:** Set the character size of the display, the device will restart automatically after changed and saved (default 48, 28-200 optional)

**Slave stream font size:** Set the character size of the display, the device will restart automatically after changed and saved (default 48, 28-200 optional)

Click on the “Save” button to display “Parameter saved successfully” message, set to take effect

**5)Video Out**

**Video Output Format:** Set the video output format

**4.2.6 Network Configure**

**1) Network port**

**Port Data:** set the data port, the device will restart automatically after changed (default 3000,0-65535 optional).

**Port Web:** Set Web port, the device will restart automatically after changed (default is 80,0-65535 is optional).

**Port Onvif:** Set Onvif port, the device will restart automatically after changed (default 2000,0-65535 optional).

**Port Soap:** Set Soap port (default 1936,0-65535 optional).

**Port RTMP:** Set RTMP port (default 1935,0-65535 optional).

**Port RTSP:** Set RTSP port, the device will restart automatically after changed (default 554,0-65535 optional).

**Port Visca:** Set Visca port, the device will restart automatically after changed (default 1259,0-65535 optional).

Click on the “Save” button, it will be valid when display “Save successful”.

**Port Https:** Set Https port (default 443).

**Port WebSocket:** Set WebSocket port (default 8088).

RTSP access: RTSP: // equipment IP address: 554/live/av0 (av0 main stream; av1 second stream)

RTMP access: RTMP: // equipment IP address: 1935 / live/av0 (av0 main stream; av1 second stream)



## 2) Ethernet

**DHCP:** Enable or disable obtain IP automatically can be set. Save changes and reboot the device to takes effect (Default: OFF)

**IP Address:** Set the IP address, save changes and reboot the device to takes effect (default 192.168.5.163). Note: This IP address is the same with the one used to login Web page.

**Subnet Mask:** Set the subnet mask (default 255.255.255.0).

**Default Gateway:** Set the default gateway (default 0.0.0.0).

**Mac Address:** Set the physical address (the parameter is read-only but cannot be modified).

Click on the “Save” button, it will be valid when display “Save successful”. (Note: To prevent IP conflicts When modify).

## 3) DNS parameters

**Preferred DNS server:** set the preferred DNS server. (Default 0.0.0.0).

**Alternate DNS server:** Alternate DNS server settings. (Default 0.0.0.0).

Click on the “Save” button, it will be valid when display “Save successful”.

## 4) GB28181

Switch: set whether open GB28181, can check

Time Synchronization: whether synchronization time is set, you can check

Stream Type: stream type setting (the default main stream, secondary stream optional)

Sign effective time (in seconds): 3600 Range 5-65535

Heartbeat time (seconds): 60 Range 1-65535

Register ID: 34020000001320000001

Register User name: IPC

Register Password: 12345678

Equipment ownership: Users can add their own

Administrative regions: Users can add their own

Alarm Zone: Users can add their own

Equipment installation address: Users can add their own

Local SIP Port: 5060 Range 0-65535

GB28181 Server Address: IP address of the computer

Server SIP Port: 5060 Range 0-65535

Server ID: 34020000002000000001

Click on the “Save” button, it will be valid when display “Save successful”.

## 5) RTSP

RTSP Authentication: Enable or Disable it and save.

## 4.2.7 System Configure

### 1) System Attribute

Device Name: Set the device name (the default Camera1, user can add their own).

Device ID: Set the device ID (default 1, Read-Only).

Language: Set the system language. Need to re-login after modify and save the setting.

Click on the “Save” button, it will be valid when display “Save successful”.

### 2) System Time

Date Format: Set the date format (YYYY-MM-DD default That year - month - day, MM-DD-YYYY namely Month - Day - Year, DD-MM-YYYY date - month - year Optional).

Date separator: set the date separator (default '/', ':', '-' Optional).

Zone: Set the time zone (default East eight districts, other time zones optional).

Hour Type: Set the time types (default 24 hours, optional 12 hours).

Time setting: Set time mode (to choose the computer time synchronization, NTP server time synchronization, or set manually).

Computer Time: Set the computer synchronization valid.

Update interval: Set the NTP server automatic updated time interval. Valid after setting NTP server synchronization (default one day,2-10 days Optional).

NTP server address or domain name: Set NTP server address or domain name (default time.nits.gov). Valid after setting NTP server synchronization.

NTP Server Port: Sets the NTP server port (default 123). Valid after setting NTP server synchronization. Set the time manually, Effective when set manually.

Click on the “Save” button, it will be valid when display “Save successful”.

### 3) Sys User

Authority: Set the user type (the default administrator, Common User 1, Common User 2 optional)

User name: set the user name (Select User Administrator default admin; select a common user1 default user1; to select a common user 2 default user2; user can modify their own)

Password: Set a password (Select User Administrator default admin; select a common user1 default user1; to select a common user 2 default user2; user can modify their own).

Confirm Password: Confirm the input passwords are the same or not.

Click on the “Save” button to display the “Save the parameters successfully” message, then the set is to take effect.

Note: Please note the case-sensitivity of the user name and password.

If login page by a common user’s name and password, one does not have configuration privileges but can only operate to preview, playback, logoff.

## 4) Update

MCU version: V2.0.0.16 2015-12-18

Camera version: V2.0.0.16 2015-12-18

AF version: V2.0.0.6 2015-12-11

Users only read the version information above which is consistent with the menu version but cannot modify. Different types of the machine have different information.

Update file:

Click "Browse ..." installation, to select the upgrade file in the pop-up window.

Click on the "Upgrade" button, the upgrade dialog will appear. the device will reboot automatically after update successfully. (Note: make sure the power and network is keeping connected during the process. or the upgrade will fail)

Note: After the version upgrade is complete, you need to restore factory defaults; a, through web to restore the factory default configuration; b, through the recovery menu; c, remote control shortcut \* # 6; Choose one of the above three ways. If chose a, the IP accounts, passwords also need to be restored to the default.

## 5) Default

Click on pop-up "Restore Factory Defaults" button and choose "yes" or "no", then the device will restart automatically and restore factory setting.

## 6) Reboot

Click on the pop-up "Reboot" button and choose "yes" or "no", then the device will restart automatically

### 4.2.8 Logout

Point "Logout" pop-up "Confirmation" dialog; select "Yes" or "No",choose "Yes" to exit the current page and return to the user login interface again.

the allocation of IP address.

## 5. Serial Communication Control

Under common working condition, the camera could be controlled through RS232/RS485 interface (VISCA), RS232C serial parameter are as follows:

Baud rate: 2400/4800/9600/115200 bits / sec; Start bit: 1; data bits: 8; Stop bit: 1; Parity: None.

After power on, the camera first goes left, then back to the middle position. Self-test is finished after the zoom moved to the farthest and then back to the nearest position. If the camera saved 0 preset before, it will be back to that position after initialization. At this point, the user can control the camera by the serial commands.

### VISCA protocol list

#### 5.1.1 Camera Return Command

Ack/Completion Message		
	Command Packet	Note
ACK	z0 41 FF	Returned when the command is accepted.
Completion	z0 51 FF	Returned when the command has been executed.

Error Messages	Command Packet	Note
Syntax Error	z0 60 02 FF	Returned when the command format is different or when a command with illegal command parameters is accepted.
Command Buffer Full	z0 60 03 FF	Indicates that two sockets are already being used(executing two commands) and the command could not be accepted when received.
Command Canceled	z0 6y 04 FF (y: Socket No.)	Returned when a command which is being executed in a socket specified by the cancel command is canceled. The completion message for the command is not returned.
No Socket	z0 6y 05 FF (y: Socket No.)	Returned when no command is executed in a socket specifild by the cancel command, or when an invalid socket number is specified.
Command Not Executable	z0 6y 41 FF (y: Execution command Socket No. Inquiry command: 0)	Returned when a command cannot be executed due to current conditions.For example, when commands controlling the focus manually are received during auto focus.

**5.1.2 Camera Control Command**

Command	Function	Command Packet	Note
AddressSet	Broadcast	88 30 0p FF	p: Address setting
IF_Clear	Broadcast	88 01 00 01 FF	I/F Clear
CAM_Power	On	8x 01 04 00 02 FF	Power ON/OFF
	Off	8x 01 04 00 03 FF	
CAM_Zoom	Stop	8x 01 04 07 00 FF	p = 0(low) - F(high)
	Tele(Standard)	8x 01 04 07 02 FF	
	Wide(Standard)	8x 01 04 07 03 FF	
	Tele(Variable)	8x 01 04 07 2p FF	
	Wide(Variable)	8x 01 04 07 3p FF	
CAM_Focus	Direct	8x 01 04 47 0p 0q 0r 0s FF	pqrs: Zoom Position
	Stop	8x 01 04 08 00 FF	p = 0(low) - F(high)
	Far(Standard)	8x 01 04 08 02 FF	
	Near(Standard)	8x 01 04 08 03 FF	
	Far(Variable)	8x 01 04 08 2p FF	
	Near (Variable)	8x 01 04 08 3p FF	
	Direct	8x 01 04 48 0p 0q 0r 0s FF	pqrs: Focus Position
	Auto Focus	8x 01 04 38 02 FF	Focus mode
	Manual Focus	8x 01 04 38 03 FF	
	One Push	8x 01 04 38 04 FF	
One Push Triger	8x 01 04 18 01 FF	One Push Triger	
CAM_Zoom Focus	Direct	8x 01 04 47 0p 0q 0r 0s 0t 0u 0v 0w FF	pqrs: Zoom Position tuvw: Focus Position
CAM_AF Sensitivity	High	8x 01 04 58 01 FF	Focus sensitivity Setting
	Normal	8x 01 04 58 02 FF	
	Low	8x 01 04 58 03 FF	
CAM_AF Zone	Top	8x 01 04 AA 00 FF	Focus Region Setting
	Center	8x 01 04 AA 01 FF	
	Bottom	8x 01 04 AA 02 FF	
	ALL	8x 01 04 AA 03 FF	

Command	Function	Command Packet	Note
CAM_WB	Auto	8x 01 04 35 00 FF	
	2400K	8x 01 04 35 0C FF	
	2500K	8x 01 04 35 0D FF	
	2600K	8x 01 04 35 0E FF	
	2700K	8x 01 04 35 0F FF	
	2800K	8x 01 04 35 10 FF	
	2900K	8x 01 04 35 11 FF	
	3000K	8x 01 04 35 01 FF	
	3100K	8x 01 04 35 12 FF	
	3200K	8x 01 04 35 13 FF	
	3300K	8x 01 04 35 14 FF	
	3400K	8x 01 04 35 15 FF	
	3500K	8x 01 04 35 07 FF	
	3600K	8x 01 04 35 16 FF	
	3700K	8x 01 04 35 17 FF	
	3800k	8x 01 04 35 18 FF	
	3900K	8x 01 04 35 19 FF	
	4000K	8x 01 04 35 02 FF	
	4100K	8x 01 04 35 1A FF	
	4200K	8x 01 04 35 1B FF	
	4300K	8x 01 04 35 1C FF	
	4400K	8x 01 04 35 1D FF	
	4500K	8x 01 04 35 08 FF	
	4600K	8x 01 04 35 1E FF	
	4700K	8x 01 04 35 1F FF	
	4800K	8x 01 04 35 21 FF	
	4900K	8x 01 04 35 22 FF	
	5000K	8x 01 04 35 04 FF	
	5100K	8x 01 04 35 23 FF	
	5200K	8x 01 04 35 24 FF	
	5300K	8x 01 04 35 25 FF	
	5400K	8x 01 04 35 26 FF	
	5500K	8x 01 04 35 09 FF	
	5600K	8x 01 04 35 27 FF	
	5700K	8x 01 04 35 28 FF	
	5800K	8x 01 04 35 29 FF	
5900K	8x 01 04 35 2A FF		
6000K	8x 01 04 35 0A FF		

Command	Function	Command Packet	Note
CAM_WB	6100K	8x 01 04 35 2B FF	
	6200K	8x 01 04 35 2C FF	
	6300K	8x 01 04 35 2D FF	
	6400K	8x 01 04 35 2E FF	
	6500K	8x 01 04 35 06 FF	
	6600K	8x 01 04 35 2F FF	
	6700K	8x 01 04 35 30 FF	
	6800K	8x 01 04 35 31 FF	
	6900K	8x 01 04 35 32 FF	
	7000K	8x 01 04 35 0B FF	
	7100K	8x 01 04 35 33 FF	
	One Push mode	8x 01 04 35 03 FF	
	One Push Trigger	8x 01 04 10 05 FF	One Push WB Trigger(Enabled during One Push WB mode)
	Manual	8x 01 04 35 05 FF	
CAM_AWB Sensitivity	Low	8x 01 04 A9 00 FF	WB Sensitivity Setting
	Normal	8x 01 04 A9 01 FF	
	High	8x 01 04 A9 02 FF	
CAM_RGain	Reset	8x 01 04 03 00 FF	Manual Control of R Gain
	Up	8x 01 04 03 02 FF	
	Down	8x 01 04 03 03 FF	
	Direct	8x 01 04 43 00 00 0p 0q FF	
CAM_Bgain	Reset	8x 01 04 04 00 FF	Manual Control of B Gain
	Up	8x 01 04 04 02 FF	
	Down	8x 01 04 04 03 FF	
	Direct	8x 01 04 44 00 00 0p 0q FF	
CAM_AE	Full Auto	8x 01 04 39 00 FF	Automatic Exposure mode
	Manual	8x 01 04 39 03 FF	Manual Control mode
	Shutter priority	8x 01 04 39 0A FF	Shutter Priority Automatic Exposure mode
	Iris priority	8x 01 04 39 0B FF	Iris Priority Automatic Exposure mode
	Bright	8x 01 04 39 0D FF	Bright mode
CAM_Shutter	Reset	8x 01 04 0A 00 FF	Shutter Setting
	Up	8x 01 04 0A 02 FF	
	Down	8x 01 04 0A 03 FF	
	Direct	8x 01 04 4A 00 00 0p 0q FF	
CAM_Iris	Reset	8x 01 04 0B 00 FF	Iris Setting
	Up	8x 01 04 0B 02 FF	
	Down	8x 01 04 0B 03 FF	
	Direct	8x 01 04 4B 00 00 0p 0q FF	

Command	Function	Command Packet	Note
CAM_Gain Limit	Reset	8x 01 04 0C 00 FF	Gain Limit Setting
	Up	8x 01 04 0C 02 FF	
	Down	8x 01 04 0C 03 FF	
	Gain Limit	8x 01 04 2C 0p FF	p: Gain Position
CAM_Bright	Reset	8x 01 04 0D 00 FF	Bright Setting
	Up	8x 01 04 0D 02 FF	
	Down	8x 01 04 0D 03 FF	
	Direct	8x 01 04 4D 00 00 0p 0q FF	pq: Bright Position
CAM_ExpComp	On	8x 01 04 3E 02 FF	Exposure Compensation ON/OFF
	Off	8x 01 04 3E 03 FF	
	Reset	8x 01 04 0E 00 FF	Exposure Compensation Amount Setting
	Up	8x 01 04 0E 02 FF	
	Down	8x 01 04 0E 03 FF	
	Direct	8x 01 04 4E 00 00 0p 0q FF	pq: ExpComp Position
CAM_Back Light	On	8x 01 04 33 02 FF	Back Light Compensation
	Off	8x 01 04 33 03 FF	
CAM_WDRStrength	Reset	8x 01 04 21 00 FF	WDR Level Setting
	Up	8x 01 04 21 02 FF	
	Down	8x 01 04 21 03 FF	
	Direct	8x 01 04 51 00 00 0p 0q FF	
CAM_NR	2D	8x 01 04 53 0p FF	P=0-7 0:OFF
	3D	8x 01 04 54 0p FF	P=0-8 0:OFF
CAM_Gamma		8x 01 04 5B 0p FF	p = 0 - 4 0: Default 1: 0.45 2: 0.50 3: 0.55 4: 0.63
CAM_Low-Light Mode	ON	8x 01 04 2D 01 FF	Low-Light Mode Setting
	OFF	8x 01 04 2D 00 FF	
CAM_Gain		8x 01 04 4C 00 00 0p 0q FF	pq: 0-20
CAM Preset-Speed		8x 01 01 0p FF	p: 1-10
CAM_Flicker	OFF	8x 01 04 23 00 FF	OFF
	50HZ	8x 01 04 23 01 FF	50HZ
	60HZ	8x 01 04 23 02 FF	60HZ
CAM_Aperture	Reset	8x 01 04 02 00 FF	Aperture Control
	Up	8x 01 04 02 02 FF	
	Down	8x 01 04 02 03 FF	
	Direct	8x 01 04 42 00 00 0p 0q FF	
CAM_Picture effect	B&W-Mode	8x 01 04 63 04 FF	Picture effect Setting
	OFF	8x 01 04 63 00 FF	
CAM_Memory	Reset	8x 01 04 3F 00 pq FF	pq: Memory Number(=0 to 254) Corresponds to 0 to 9 on the Remote Commander
	Set	8x 01 04 3F 01 pq FF	
	Recall	8x 01 04 3F 02 pq FF	



Command	Function	Command Packet	Note
CAM_LR_Reverse	On	8x 01 04 61 02 FF	Image Flip Horizontal ON/OFF
	Off	8x 01 04 61 03 FF	
CAM_PictureFlip	On	8x 01 04 66 02 FF	Image Flip Vertical ON/OFF
	Off	8x 01 04 66 03 FF	
CAM_ColorSaturation	Direct	8x 01 04 49 00 00 00 0p FF	P: 0~E
CAM_IDWrite		8x 01 04 22 0p 0q 0r 0s FF	pqrs: Camera ID (=0000 to FFFF)
SYS_Menu	ON	8x 01 04 06 06 02 FF	Turn on the menu screen
	OFF	8x 01 04 06 06 03 FF	Turn off the menu screen
IR_Receive	ON	8x 01 06 08 02 FF	IR(remote commander)receive On/Off
	OFF	8x 01 06 08 03 FF	
CAM_Setting Reset	Reset	8x 01 04 A0 10 FF	Reset Factory Setting
CAM_Brightness	Direct	8x 01 04 A1 00 00 0p 0q FF	pq: Brightness Position
CAM_Contrast	Direct	8x 01 04 A2 00 00 0p 0q FF	pq: Contrast Position
CAM_Flip	OFF	8x 01 04 A4 00 FF	Single Command For Video Flip
	Flip-H	8x 01 04 A4 01 FF	
	Flip-V	8x 01 04 A4 02 FF	
	Flip-HV	8x 01 04 A4 03 FF	
CAM_Video System	Set camera video system	8x 01 06 35 00 0p FF	P: 0~E Video format
Pan_tiltDrive	Up	8x 01 06 01 VV WW 03 01 FF	VV: Pan speed 0x01 (low speed) to 0x18 (high speed) WW: Tilt speed 0x01 (low speed) to 0x14 (high speed) YYYY: Pan Position ZZZZ: Tilt Position
	Down	8x 01 06 01 VV WW 03 02 FF	
	Left	8x 01 06 01 VV WW 01 03 FF	
	Right	8x 01 06 01 VV WW 02 03 FF	
	Upleft	8x 01 06 01 VV WW 01 01 FF	
	Upright	8x 01 06 01 VV WW 02 01 FF	
	DownLeft	8x 01 06 01 VV WW 01 02 FF	
	DownRight	8x 01 06 01 VV WW 02 02 FF	
	Stop	8x 01 06 01 VV WW 03 03 FF	
	Absolute Position	8x 01 06 02 VV WW 0Y 0Y 0Y 0Y 0Z 0Z 0Z 0Z FF	
	Relative Position	8x 01 06 03 VV WW 0Y 0Y 0Y 0Y 0Z 0Z 0Z 0Z FF	
Home	8x 01 06 04 FF		
Reset	8x 01 06 05 FF		
Pan-tiltLimitSet	Set	8x 01 06 07 00 0W 0Y 0Y 0Y 0Y 0Z 0Z 0Z 0Z FF	W:1 UpRight 0:DownLeft YYYY: Pan Limit Position(TBD) ZZZZ: Tilt Limit Position(TBD)
	Clear	8x 01 06 07 01 0W 07 0F 0F 0F 07 0F 0F 0F FF	

### 5.1.3 Inquiry Command

Command	Command Packet	Return Packet	Note
CAM_PowerInq	8x 09 04 00 FF	y0 50 02 FF	On
		y0 50 03 FF	Off(Standby)
CAM_ZoomPosInq	8x 09 04 47 FF	y0 50 0p 0q 0r 0s FF	pqrs: Zoom Position
CAM_FocusAFModelInq	8x 09 04 38 FF	y0 50 02 FF	Auto Focus
		y0 50 03 FF	Manual Focus
		y0 50 04 FF	One Push mode
CAM_FocusPosInq	8x 09 04 48 FF	y0 50 0p 0q 0r 0s FF	pqrs: Focus Position
CAM_AFSensitivityInq	8x 09 04 58 FF	y0 50 01 FF	High
		y0 50 02 FF	Normal
		y0 50 03 FF	Low
CAM_AFZoneInq	8x 09 04 AA FF	y0 50 00 FF	Top
		y0 50 01 FF	Center
		y0 50 02 FF	Bottom
		y0 50 03 FF	All
CAM_WBModelInq	8x 09 04 35 FF	y0 50 pq FF	pq: WB Mode
CAM_AWBSensitivityInq	8x 09 04 A9 FF	y0 50 00 FF	Low
		y0 50 01 FF	Normal
		y0 50 02 FF	High
CAM_RGainInq	8x 09 04 43 FF	y0 50 0B FF	
CAM_BGainInq	8x 09 04 44 FF	y0 50 00 00 0p 0q FF	pq: B Gain
CAM_AEModelInq	8x 09 04 39 FF	y0 50 00 FF	Full Auto
		y0 50 03 FF	Manual
		y0 50 0A FF	Shutter priority
		y0 50 0B FF	Iris priority
		y0 50 0D FF	Bright
CAM_ShutterPosInq	8x 09 04 4A FF	y0 50 00 00 0p 0q FF	pq: Shutter Position
CAM_IrisPosInq	8x 09 04 4B FF	y0 50 00 00 0p 0q FF	pq: Iris Position
CAM_Gain LimitInq	8x 09 04 2C FF	y0 50 0p FF	p: Gain Position
CAM_BrightPosInq	8x 09 04 4D FF	y0 50 00 00 0p 0q FF	pq: Bright Position
CAM_ExpCompModelInq	8x 09 04 3E FF	y0 50 02 FF	On
		y0 50 03 FF	Off
CAM_ExpCompPosInq	8x 09 04 4E FF	y0 50 00 00 0p 0q FF	pq: ExpComp Position
CAM_BacklightModelInq	8x 09 04 33 FF	y0 50 02 FF	On
		y0 50 03 FF	Off
CAM_WDRStrengthInq	8x 09 04 51 FF	y0 50 00 00 00 0p FF	p: WDR Strength
CAM_NRLLevel(2D) Inq	8x 09 04 53 FF	y0 50 0p FF	P: 2DNRLLevel
CAM_NRLLevel(3D) Inq	8x 09 04 54 FF	y0 50 0p FF	P:3D NRLevel

Command	Command Packet	Return Packet	Note
CAM_FlickerModelInq	8x 09 04 55 FF	y0 50 0p FF	p: Flicker Settings(0: OFF, 1: 50Hz, 2:60Hz)
CAM_ApertureInq	8x 09 04 42 FF	y0 50 00 00 0p 0q FF	pq: Aperture Gain
CAM_PictureEffect-ModelInq	8x 09 04 63 FF	y0 50 00 FF	Off
		y0 50 04 FF	B&W
CAM_MemoryInq	8x 09 04 3F FF	y0 50 0p FF	p: Memory number last operated.
SYS_MenuModelInq	8x 09 06 06 FF	y0 50 02 FF	On
		y0 50 03 FF	Off
CAM_LR_ReverseInq	8x 09 04 61 FF	y0 50 02 FF	On
		y0 50 03 FF	Off
CAM_PictureFlipInq	8x 09 04 66 FF	y0 50 02 FF	On
		y0 50 03 FF	Off
CAM_ColorSaturationInq	8x 09 04 49 FF	y0 50 00 00 00 0p FF	p: Color Gain setting 0h (60%) to Eh (130%)
CAM_IDInq	8x 09 04 22 FF	y0 50 0p FF	Camera ID
IR_ReceiveInq	8x 09 06 08 FF	y0 50 02 FF	On
		y0 50 03 FF	Off
CAM_BrightnessInq	8x 09 04 A1 FF	y0 50 00 00 0p 0q FF	pq: Brightness Position
CAM_ContrastInq	8x 09 04 A2 FF	y0 50 00 00 0p 0q FF	pq: Contrast Position
CAM_FlipInq	8x 09 04 A4 FF	y0 50 00 FF	Off
		y0 50 01 FF	Flip-H
		y0 50 02 FF	Flip-V
		y0 50 03 FF	Flip-HV
CAM_GammaInq	8x 09 04 5B FF	y0 50 0p FF	p: Gamma setting
CAM_VersionInq	8x 09 00 02 FF	y0 50 ab cd mn pq rs tu vw FF	ab cd : vender ID ( 0220 ) mn pq : model ID rs tu : ARM Version vw : reserve
VideoSystemInq	8x 09 06 23 FF	y0 50 0p FF	P: 0~E Video format
Pan-tiltMaxSpeedInq	8x 09 06 11 FF	y0 50 ww zz FF	ww: Pan Max Speed zz: Tilt Max Speed
Pan-tiltPosInq	8x 09 06 12 FF	y0 50 0w 0w 0w 0w 0z 0z 0z 0z FF	www: Pan Position zzzz: Tilt Position

## 6. Camera Maintenance and Troubleshooting

### 6.1 Camera Maintenance

- 1) If camera is not used for long time, please turn off power adapter switch and AC plug.
- 2) Use soft cloth or tissue to clean the camera cover.
- 3) Use soft cloth to clean the lens; Use monitor cleanser if there is bad smearing. Do not use strong or corrosive cleanser or corrosive cleaner to avoid scratches and scuffing.

### 6.2 Troubleshooting

#### 1) No video output

- a. Check whether the camera power supply is connected, the voltage is normal, and the power indicator is ON.
- b. Check whether the machine is in self-inspection mode after restarted.
- c. Check whether the DIP switches are in normal operating mode (see Table 2.2 and Table 2.3)
- d. Check cables and monitor, swap out to check for bad cables or monitor settings.

#### 2) No image sometimes (intermittent)

- a. Check whether the video output cable or video display is normal

#### 3) Image vibration when zoom-in or zoom-out

- a. Check whether the camera installation position is solid
- b. Check whether there is a machine, HVAC, or other units shaking camera or objects around the camera

#### 4) Remote controller does not operate camera

- a. Check IR remote camera address is set to 1 (if the camera is set back to factory defaults, remote control addresses need to be set back to 1 as well)
- b. Check whether the battery is installed on the remote controller or if it's low.
- c. Check the camera working mode is the normal operating mode (see Table 2.2 and Table 2.3)
- d. Check the menu whether it is closed, camera control through remote controller is only available after exiting the menu. If video output from IP (LAN), menu will not be displayed, menu will automatically appear 30 seconds later, then it can be controlled by remote controller.

#### 5) Serial port does not work.

- a. Check whether the camera serial device protocol, baud rate, address matches RS232 control source.
- b. Check whether the control cable is connected securely and check for cable integrity.
- c. Check whether the camera working mode is the normal operating mode (see Table 2.2 and Table 2.3)

#### 6) Web pages cannot log in

- a. Check whether the camera is showing normal operation in other outputs.
- b. Check whether the network cable is connected properly (Ethernet port yellow light flashes to indicate normal network cable connection)
- c. Check whether your computer is added to the segment and the segment is consistent with the IP address of the camera.
  - d. Click on "Start" menu in computer OS and select "Run" and then type "CMD" in the computer; Click "OK" then turn on a DOS command window to enter ping 192.168.5.163. Press the Enter key to check for message as follows: Description network connection is normal