

Acer DLP Projector  
H6815/E8615/HE-4K15/  
GM835/VH-736/H6815BD+/  
H6815ABD/H6815BD/H6815+/  
H6815A/H6822BD/A4K2008/  
H6830BD/E8630/HE-4K30/  
GM835Z/VH-736Z/  
H6830BDZ+/H6831BD/  
H6830BD+/H6830/A4K2111  
Series User's Guide

Copyright © 2020. Acer Incorporated.  
All Rights Reserved.

Acer Projector User's Guide  
Original Issue: 11/2020

Changes may be made periodically to the information in this publication without obligation to notify any person of such revisions or changes. Such changes will be incorporated in new editions of this manual or supplementary documents and publications. This company makes no representations or warranties, either expressed or implied, with respect to the contents hereof and specifically disclaims the implied warranties of merchantability or fitness for a particular purpose.

Record the model number, serial number, purchase date and place of purchase information in the space provided below. The serial number and model number are recorded on the label affixed to your projector. All correspondence concerning your unit should include the serial number, model number and purchase information.

No part of this publication may be reproduced, stored in a retrieval system, or transmitted, in any form or by any means, electronically, mechanically, by photocopy, recording or otherwise, without the prior written permission of Acer Incorporated.

Acer Projector

Model number: \_\_\_\_\_

Serial number: \_\_\_\_\_

Date of purchase: \_\_\_\_\_

Place of purchase: \_\_\_\_\_

Acer and the Acer logo are registered trademarks of Acer Incorporated. Other companies' product names or trademarks are used herein for identification purposes only and belong to their respective companies.

The terms HDMI, HDMI High-Definition Multimedia Interface, HDMI Trade dress and the HDMI Logos are trademarks or registered trademarks of HDMI Licensing Administrator, Inc.

# Information for Your Safety and Comfort

Read these instructions carefully. Keep this document for future reference. Follow all warnings and instructions marked on the product.

## Turning the product off before cleaning

Unplug this product from the wall outlet before cleaning. Do not use liquid cleaners or aerosol cleaners. Use a damp cloth for cleaning.

## Caution for plug as disconnecting device

Observe the following guidelines when connecting and disconnecting power to the external power supply unit:

- Install the power supply unit before connecting the power cord to the AC power outlet.
- Unplug the power cord before removing the power supply unit from the projector.
- If the system has multiple sources of power, disconnect power from the system by unplugging all power cords from the power supplies.

## Caution for Accessibility

Be sure that the power outlet you plug the power cord into is easily accessible and located as close to the equipment operator as possible. When you need to disconnect power to the equipment, be sure to unplug the power cord from the electrical outlet.



### Warnings!

- Do not use this product near water.
- Do not place this product on an unstable cart, stand or table. If the product falls, it could be seriously damaged.
- Slots and openings are provided for ventilation to ensure reliable operation of the product and to protect it from overheating. These openings must not be blocked or covered. The openings should never be blocked by placing the product on a bed, sofa, rug or other similar surface.

This product should never be placed near or over a radiator or heat register, or in a built-in installation unless proper ventilation is provided.

- Never push objects of any kind into this product through cabinet slots as they may touch dangerous voltage points or short-out parts that could result in a fire or electric shock. Never spill liquid of any kind onto or into the product.

- To avoid damage of internal components and to prevent battery leakage, do not place the product on a vibrating surface.
- Never use it under sporting, exercising, or any vibrating environment which will probably cause unexpected short current or damage rotor devices or lamp.

## Using electrical power

- This product should be operated from the type of power indicated on the marking label. If you are not sure of the type of power available, consult your dealer or local power company.
- Do not allow anything to rest on the power cord. Do not locate this product where people will walk on the cord.
- If an extension cord is used with this product, make sure that the total ampere rating of the equipment plugged into the extension cord does not exceed the extension cord ampere rating. Also, make sure that the total rating of all products plugged into the wall outlet does not exceed the fuse rating.
- Do not overload a power outlet, strip or receptacle by plugging in too many devices. The overall system load must not exceed 80% of the branch circuit rating. If power strips are used, the load should not exceed 80% of the power strip's input rating.
- This product's AC adapter is equipped with a three-wire grounded plug. The plug only fits in a grounded power outlet. Make sure the power outlet is properly grounded before inserting the AC adapter plug. Do not insert the plug into a non-grounded power outlet. Contact your electrician for details.



.....  
**Warning! The grounding pin is a safety feature. Using a power outlet that is not properly grounded may result in electric shock and/or injury.**



.....  
**Note: The grounding pin also provides good protection from unexpected noise produced by other nearby electrical devices that may interfere with the performance of this product.**

- Use the product only with the supplied power supply cord set. If you need to replace the power cord set, make sure that the new power cord meets the following requirements: detachable type, UL listed/CSA certified, VDE approved or its equivalent, 4.5 meters (14.76 feet) maximum length.

## Product servicing

Do not attempt to service this product yourself, as opening or removing covers may expose you to dangerous voltage points or other risks. Refer all servicing to qualified service personnel.

Unplug this product from the wall outlet and refer servicing to qualified service personnel when:

- the power cord or plug is damaged, cut or frayed
- liquid was spilled into the product
- the product was exposed to rain or water
- the product has been dropped or the case has been damaged
- the product exhibits a distinct change in performance, indicating a need for service
- the product does not operate normally after following the operating instructions



.....

**Note: Adjust only those controls that are covered by the operating instructions, since improper adjustment of other controls may result in damage and will often require extensive work by a qualified technician to restore the product to normal condition.**



.....

**Warning! For safety reasons, do not use non-compliant parts when adding or changing components. Consult your reseller for purchase options.**

Your device and its enhancements may contain small parts. Keep them out of the reach of small children.

## Additional safety information

- Do not look into the projector's lens when the lamp is on. The bright light may hurt your eyes.



RG2 IEC 62471-5:2015

- Turn on the projector first and then signal sources.
- Do not place the product in the following environments:
  - Space that is poorly ventilated or confined. At least 50cm clearance from walls and free flow of air around the projector are necessary.
  - Locations where temperatures may become excessively high, such as inside of a car with all windows rolled up.
  - Locations where excessive humidity, dust, or cigarette smoke may contaminate optical components, shorten the life span and darken the image.
  - Locations near fire alarms.
  - Locations with an ambient temperature above 40 °C/104 °F. Such environment

may cause the fan(s) to operate in standby mode.

- Locations where the altitudes are higher than 10000 feet.
- Unplug immediately if there is something wrong with your projector. Do not operate if smoke, strange noise or odor comes out of your projector. It might cause fire or electric shock. In this case, unplug immediately and contact your dealer.
- Do not keep using this product to break or drop it. In this case contact your dealer for inspection.
- Do not face the projector lens to the sun. It can lead to fire.
- When switching the projector off, please ensure the projector completes its cooling cycle before disconnecting power.
- Do not frequently turn off the main power abruptly or unplug the projector during operation. The best way is to wait for the fan to stop before turning main power off.
- Do not touch the air outlet grille and bottom plate which become hot.
- Clean the air filter frequently. The temperature inside may rise and cause damage when the filter/ventilation slots are clogged with dirt or dust.
- Do not look into the air outlet grille when projector is operating. It may hurt your eyes.
- Always open the lens shutter or remove the lens cap when the projector is on.
- Do not block the projector lens with any object when the projector is under operation as this could cause the object to become heated and deformed or even cause a fire. To temporarily turn off the lamp, press HIDE on the remote control.
- Do not operate lamps beyond the rated lamp life. It could cause it to break on rare occasions.
- Contact your local dealer or Acer service center when you need to change the lamp.
- The product will detect the life of the lamp itself. Please contact your local dealer or Acer service center for changing the lamp, when lamp warning message displays.
- Do not attempt to disassemble this projector. There are dangerous high voltages inside which may hurt you.
- Do not stand the projector on end vertically. It may cause the projector to fall over, causing injury or damage.
- This product is capable of displaying inverted images for ceiling mount installation. Only use acer ceiling mount kit for mounting the projector and ensure it is securely installed.
- The projector should be placed in a horizontal way by means of desktop or ceiling mount mode only, and its tilt angles should not exceed 6 degrees, otherwise it would cause dramatical decrease of lamp life or severe safety concern of system malfunction.



## Caution for Listening

To protect your hearing, follow these instructions.

- Increase the volume gradually until you can hear clearly and comfortably.
- Do not increase the volume level after your ears have adjusted.
- Do not listen to music at high volumes for extended periods.
- Do not increase the volume to block out noisy surroundings.
- Decrease the volume if you can't hear people speaking near you.

## Disposal instructions

Do not throw this electronic device into the trash when discarding. To minimize pollution and ensure utmost protection of the global environment, please recycle. For more information on the Waste from Electrical and Electronics Equipment (WEEE) regulations, visit <http://www.acer-group.com/public/Sustainability/index.htm>



## Mercury advisory

For projectors or electronic products containing an LCD/CRT monitor or display:



"Lamp(s) contain Mercury,  
Dispose Properly."

Lamp(s) inside this product contain mercury and must be recycled or disposed of according to local, state or federal laws. For more information, contact the Electronic Industries Alliance at [www.eiae.org](http://www.eiae.org). For lamp-specific disposal information, check [www.lamprecycle.org](http://www.lamprecycle.org)

# First Thing First

## Usage Notes

Do:

- Turn off the product before cleaning.
- Use a soft cloth moistened with mild detergent to clean the display housing.
- Disconnect the power plug from AC outlet if the product is not being used for a long period of time.

Don't:

- Block the slots and openings on the projector provided for ventilation.
- Use abrasive cleaners, waxes or solvents to clean the unit.
- Use under the following conditions:
  - In extremely hot, cold or humid environments.
  - In areas susceptible to excessive dust and dirt.
  - Near any appliance that generates a strong magnetic field.
  - Place in direct sunlight.

## Precautions

Follow all warnings, precautions and maintenance as recommended in this user's guide to maximize the life of your unit.



### Warning:

- Do not look into the projector's lens when the lamp is on. The bright light may hurt your eyes.
- To reduce the risk of fire or electric shock, do not expose this product to rain or moisture.
- Please do not open or disassemble the product as this may cause electric shock.
- The product will detect the life of the lamp itself. Please contact your local dealer or Acer service center for changing the lamp, when lamp warning message displays.
- When switching the projector off, please ensure the projector completes its cooling cycle before disconnecting power.
- Turn on the projector first and then the signal sources.
- Do not use lens cap when projector is in operation.
- When the lamp reaches the end of its life, it will burn out and may make a loud popping sound. If this happens, the projector will not turn back on until the lamp module has been replaced. To replace the lamp, contact your local dealer or Acer service center.



Information for Your Safety and Comfort	iii
First Thing First	viii
Usage Notes	viii
Precautions	viii
Introduction	1
Product Features	1
Package Overview	2
Projector Overview	3
Projector Outlook	3
Control Panel	4
Remote Control Layout	5
Getting Started	7
Connecting the Projector	7
Turning the Projector On/Off	9
Turning On the Projector	9
Turning Off the Projector	10
Adjusting the Projected Image	11
Adjusting the Height of the Projected Image	11
How to Get a Preferred Image Size by Adjusting Distance and Zoom	12
User Controls	14
Installation Menu	14
Onscreen Display (OSD) Menus	15
Color	16
Image	19
Setting	22
Management	24
Audio	26
3D	27
Language	27
Acer Splash Downloader	28
Introduction	28
Using the Acer Splash Downloader	28

# Contents

<b>Appendices</b>	<b>31</b>
Troubleshooting	31
LED & Alarm Definition Listing	35
Ceiling Mount Installation	36
Specifications	39
Compatibility Modes	42
<b>Regulations and safety notices</b>	<b>44</b>

# Introduction

## Product Features

This product is a single-chip DLP® projector, including the following outstanding features:

- DLP® technology
- Acer ColorBoost technology delivers vivid, life-like images
- High brightness and contrast ratio
- Versatile display modes enable optimum performance in any situation
- NTSC/PAL/SECAM compatible and HDTV (720p, 1080i, 1080p) supported
- Lower power consumption, economy (ECO) mode and EcoPro mode extend lamp life
- Dynamic Black / ExtremeEco functions help decrease lamp power consumption and further extend lamp life.
  - Dynamic Black: If turned on, the projector dynamically adjusts the power consumption of the lamp according to the brightness of the image being projected. When projecting darker images the power consumption will be reduced and the contrast of the image will also be enhanced.
  - ExtremeEco: The projector will decrease the power consumption of the lamp by up to 70% when no input signal can be detected for 15 minutes.
- Acer EcoProjection Technology delivers Intelligent power management approach and physical efficiency improvement
- Advanced keystone correction delivers optimum presentations
- Multi-language Onscreen Display (OSD) menus
- Manual focus/zoom projection lens
- 0.8 ~ 2X digital zoom and pan move function
- Microsoft® Windows® 2000, XP, 7, 8, 8.1, 10, Vista®, Macintosh OS, Chrome OS compliant
- CEC (Consumer Electronics Control) function supported
- LumiSense supported
- BluelightShield function supported
- Low input lag function helps reduce display input lag
- 1080p 120Hz supported
- Acer Display Widget supported
- Compatible with Acer Splash Downloader
- Digital Zoom Out (Install) and Image Shift functions allow projected image to be shifted toward the direction you choose

## Package Overview

This projector comes with all the items shown below. Check to make sure you have them all. Contact your dealer immediately if any thing is missing.

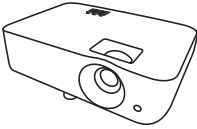

Projector



Power cord



VGA cable  
(Optional)



HDMI cable  
(Optional)



Security card  
(Optional)

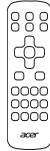

Remote control



Quick start guide



AAA Battery x 2



Carrying case  
(Optional)

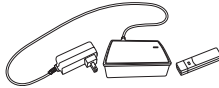

WirelessHD dongle kit (MWIHD1)  
(Optional)



WirelessCAST  
(Optional)



WirelessProjection-  
Kit (Optional)



**Note:** The package content may differ by regions.

# Projector Overview

## Projector Outlook

Front/upper side

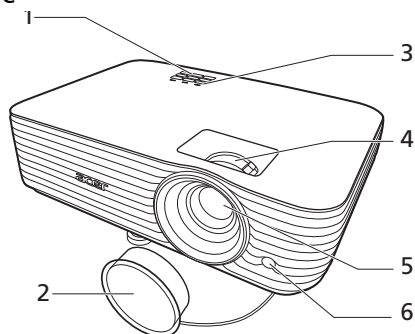

#	Description	#	Description
1	Control panel	4	Zoom ring and Focus ring
2	Lens cap	5	Projection lens
3	Power key and Power indicator LED	6	IR remote sensor

Rear side

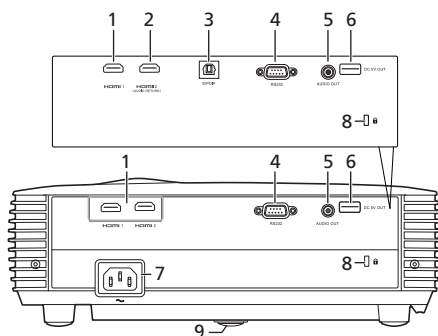

Note: Connector interface is subject to model's specifications.

#	Description	#	Description
1	HDMI connector(s)	6	DC 5V output (service)
2	HDMI connector (audio return)	7	Power socket
3	S/PDIF port	8	Kensington™ lock port
4	RS232 connector	9	Tilt adjusting wheel
5	Audio output connector		



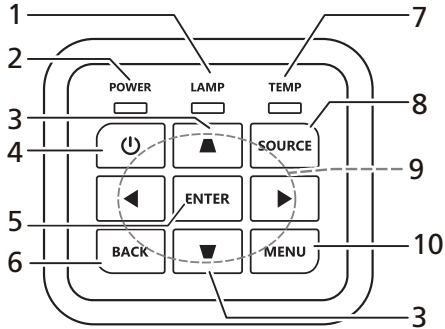

## Control Panel

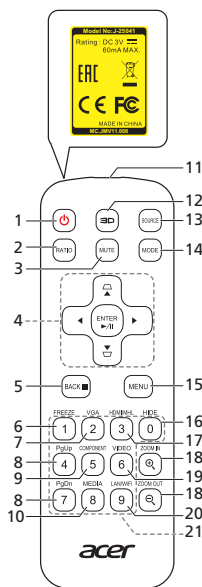

#	Function	Description
1	LAMP	Lamp indicator LED.
2	POWER	Power indicator LED
3	Keystone	Adjusts image distortion caused by tilting projection.
4	Power key	Refer to the "Turning the Projector On/Off" section.
5	ENTER	Confirms your selection of items.
6	BACK	Cancels your selection, or goes back to previous page.
7	TEMP	Temperature indicator LED.
8	SOURCE	Changes the active source.
9	Four directional selection keys	Selects items or makes adjustments to your selection
10	MENU	Launches the Onscreen Display (OSD) menu, returns to the previous step for the OSD menu operation or exits the OSD menu.

## Remote Control Layout



#	Function	Description
1	POWER	Refer to the "Turning the Projector On/Off" section.
2	RATIO	Chooses an aspect ratio.
3	MUTE	Mutes or unmutes the projector's volume.
4	 Keystone	Adjusts image distortion caused by tilting projection.
	 Four directional selection keys	Selects items or makes adjustments to your selection.
	ENTER  Play/Pause	Confirms your selection of items.
5	BACK	Cancels your selection, or goes back to previous page.
	 Stop	
6	FREEZE	To pause the screen image.
7	VGA	To change source to VGA. This connection supports analog RGB, and YPbPr (480i/480p/576i/576p/720p/1080i/1080p).

#	Function	Description
8	PgUp/PgDn	For computer mode only. Use this button to select the next or previous page. This function is only available when connected to a computer via a mini USB cable.
9	COMPONENT	(No function)
10	MEDIA	Opens MEDIA SETUP page. (for LAN/wireless compatible models)
11	Infrared transmitter	Sends signals to the projector.
12	3D	Press to open the 3D menu for adjusting 3D settings.
13	SOURCE	Changes the active source.
14	MODE	Chooses a display mode.
15	MENU	Launches the Onscreen Display (OSD) menu or exits the OSD menu.
16	HIDE	Press "HIDE" to hide screen image; press again to display the image.
17	HDMI/MHL	To change source to HDMI™ (or MHL). (for the model with HDMI™ or MHL connector)
18	ZOOM IN/ZOOM OUT	Zooms the projector display in or out.
19	VIDEO	To change source to composite video.
20	LAN/WiFi	To change source to LAN/WiFi. (for LAN/wireless compatible models)
21	Keypad 0~9	(No function)



# Getting Started

## Connecting the Projector

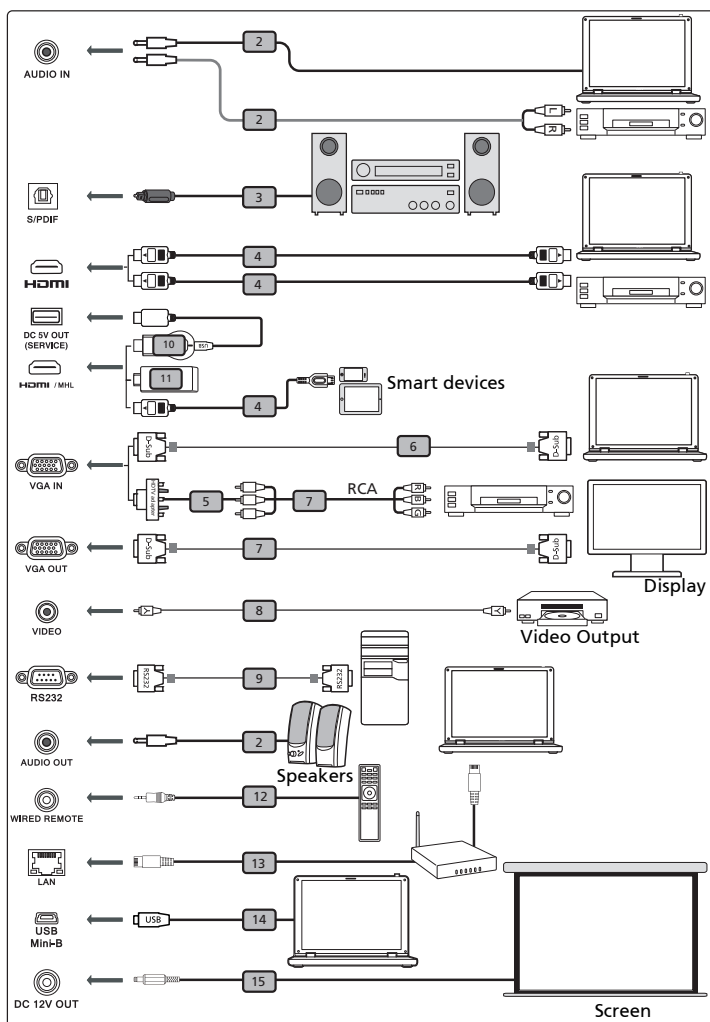

Note: Connector interface is subject to model's specifications.

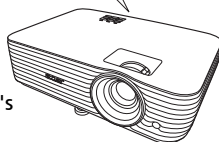

#	Description	#	Description
1	Power cord	9	RS232 cable
2	Audio cable	10	Wireless dongle
3	S/PDIF audio cable	11	WirelessHD dongle
4	HDMI (MHL) cable	12	Wired remote control
5	VGA to component video/HDTV adapter	13	RJ45 cable
6	VGA cable	14	USB cable
7	3 RCA component cable	15	12V DC cable
8	Composite video cable		



.....

**Note:** To ensure the projector works well with your computer, please make sure the timing of the display mode is compatible with the projector.

# Turning the Projector On/Off

## Turning On the Projector

- 1 Ensure that the power cord and signal cable are securely connected. The Power LED will light red.
- 2 Turn on the projector by pressing  (POWER) on the control panel or remote control, and the Power indicator LED will turn blue.
- 3 Turn on your source (computer, notebook, video player, etc.). The projector will detect your source automatically (when it is the first time you turn on the projector or the Source Selection function is "Auto").
  - If the screen displays "No Signal", please make sure the signal cables are securely connected.
  - If you connect to multiple sources at the same time, use "SOURCE" on the control panel or remote control, or the direct source key on the remote control to switch between inputs.

## Turning Off the Projector

- 1 To turn the projector off, press the power button. This message appears:  
**"Please press power button again to complete the shutdown process"**  
 Press the power button again.
- 2 The LED Power indicator will turn solid red to indicate standby mode.
- 3 It is now safe to unplug the power cord.

### When Instant Resume is selected:

- 1 The LED Power indicator will turn RED and blink rapidly after the projector is turned off, and the fan(s) will continue to operate for about 2 minutes to ensure that the system cools properly.
- 2 As long as the power cord remains plugged in, you can press the power button to turn the projector immediately back on anytime during the 2-minute shutdown process.
- 3 Once the system has finished cooling, the LED Power indicator will stop blinking and turn solid red to indicate standby mode.
- 4 It is now safe to unplug the power cord.



#### Warning indicators:

- **"Projector Overheated. Lamp will automatically turn off soon."**  
 This onscreen message indicates that the projector has overheated. The lamp will automatically turn off, the projector will automatically shut down, and the LED Temp indicator will turn solid red. Contact your local dealer or service center.
- **"Fan failed. Lamp will automatically turn off soon."**  
 This onscreen message indicates that the fan has failed. The lamp will automatically turn off, the projector will automatically shut down, and the LED Temp indicator will blink. Contact your local dealer or service center.



**Note:** Whenever the projector automatically shuts down and the LED Temp indicator turns solid red, contact your local reseller or service center.

# Adjusting the Projected Image

## Adjusting the Height of the Projected Image

The projector is equipped with elevator feet for adjusting the image height.

To raise the image:

- 1 Use the front Tilt adjusting wheel to raise the image to the desired height and angle.

To lower the image:

- 1 Use the front Tilt adjusting wheel to lower the image to the desired height and angle.

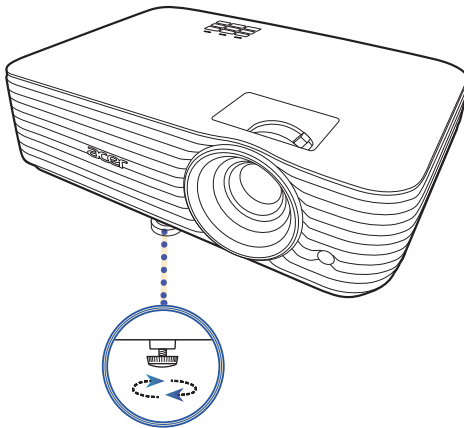

Tilt adjusting wheel

## How to Get a Preferred Image Size by Adjusting Distance and Zoom

The table below shows how to achieve a desired image size by adjusting either the position or the zoom ring.

- Resolution: 3840 x 2160, Zoom ratio: 1.1x

To obtain an image size of 70", set the projector at a distance between 2.3 m and 2.6 m from the screen and adjust the zoom level accordingly.

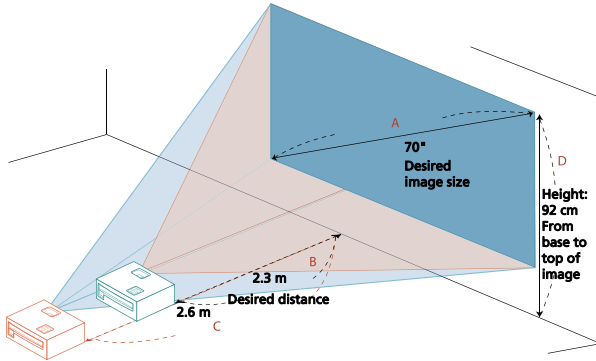

Desired Image Size		Distance (m)		Top (cm)
Diagonal (inch) < A >	W (cm) x H (cm)	Max zoom < B >	Min zoom < C >	From base to top of image < D >
30	66 x 37		1.1	39
40	89 x 50	1.3	1.5	52
50	111 x 62	1.7	1.8	65
60	133 x 75	2.0	2.2	78
70	155 x 87	2.3	2.6	92
80	177 x 100	2.7	2.9	105
90	199 x 112	3.0	3.3	118
100	221 x 125	3.3	3.7	131
120	266 x 149	4.0	4.4	157
150	332 x 187	5.0	5.5	196
180	398 x 224	6.0	6.6	235
200	443 x 249	6.6	7.3	262
250	553 x 311	8.3	9.1	327
300	664 x 374	10.0		392

- Resolution: 3840 x 2160, Zoom ratio: 1.3x  
To obtain an image size of 70", set the projector at a distance between 1.7 m and 2.3 m from the screen and adjust the zoom level accordingly.

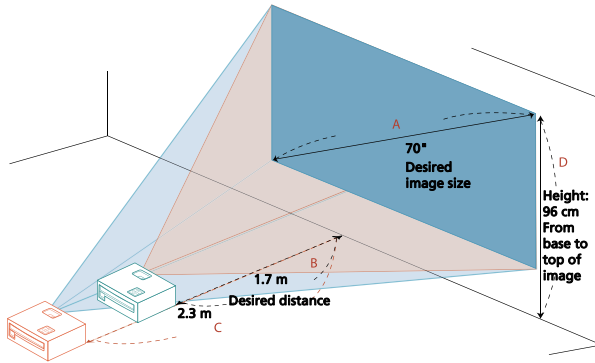

Desired Image Size		Distance (m)		Top (cm)
Diagonal (inch) < A >	W (cm) x H (cm)	Max zoom < B >	Min zoom < C >	From base to top of image < D >
30	66 x 37	0.7	1.0	41
40	89 x 50	1.0	1.3	55
50	111 x 62	1.2	1.6	68
60	133 x 75	1.5	1.9	82
70	155 x 87	1.7	2.3	96
80	177 x 100	2.0	2.6	110
90	199 x 112	2.2	2.9	123
100	221 x 125	2.5	3.2	137
120	266 x 149	3.0	3.9	164
150	332 x 187	3.7	4.8	205
180	398 x 224	4.5	5.8	247
200	443 x 249	5.0	6.5	274
250	553 x 311	6.2	8.1	342
300	664 x 374	7.5	9.7	411

# User Controls

## Installation Menu

The Installation menu provides an Onscreen Display (OSD) for projector installation and maintenance. Use the OSD only when the message "No signal" is displayed on the screen or when the projector searches for input signal.

- 1 Turn on the projector by pressing  (POWER) on the control panel or remote control.
- 2 Press "MENU" on the control panel or remote control to launch the OSD for projector installation and maintenance.

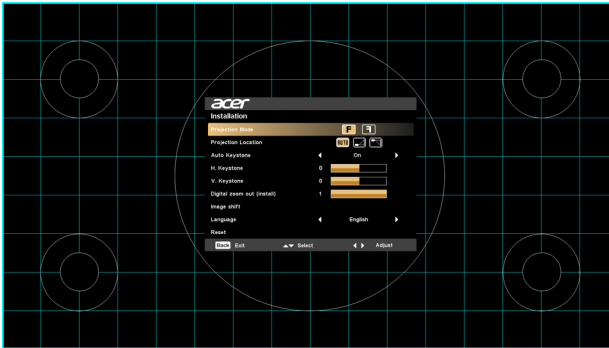

- 3 The background pattern acts as a guide to adjusting the calibration and alignment settings, such as screen size and distance, focus and more.



**Note:** The OSD screenshot is for reference only and may differ from the actual design.

- 4 The Installation menu includes several options.  
Use the up and down arrow keys to select an option, the left and right arrow keys to adjust selected option settings, and the right arrow key to enter a submenu for feature setting. The new settings will be saved automatically upon exiting the menu.
- 5 Press "MENU" anytime to exit the menu and return to the Acer welcome screen.



## Onscreen Display (OSD) Menus

The projector has multilingual Onscreen Display (OSD) menus that allow you to make image adjustments and change a variety of settings.

### Using the OSD menus

- To open the OSD menu, press "MENU" on the control panel or remote control.
- When the OSD is displayed, use ▲ ▼ to select an item in the main menu. After selecting the desired main menu item, press ► to enter a submenu for feature setting.
- Use ▲ ▼ to select the desired item and adjust the settings by using ◀ ▶.
- Select the next item to be adjusted in the submenu and adjust as described above.
- Press "MENU" on the control panel or remote control, the screen will return to the main menu.
- To exit the OSD menu, press "MENU" on the control panel or remote control again. It will close and the projector will automatically save the new settings.

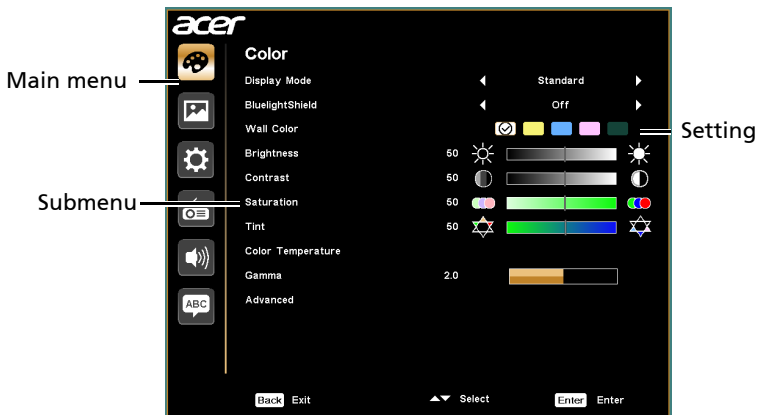

**Note:** Some of the following OSD settings may not be available. Please refer to the actual OSD of your projector.

# Color

<b>BluelightShield</b>	<p>This function protects your eyes from over-exposure to blue light. The options are Off, Level 1, Level 2, Level 3, and Level 4. Choose a preferred setting to reduce the level of blue light and get a comfortable viewing experience.</p>  <p>-----</p> <p>When this function is enabled, LumiSense will be automatically set to "Off".</p>
<b>Display Mode</b>	<p>There are many factory presets optimized for various types of images.</p> <ul style="list-style-type: none"> <li>• Bright: For brightness optimization.</li> <li>• Presentation: For meeting presentation with higher brightness.</li> <li>• Standard: For common environment.</li> <li>• Video: For playing video in a bright environment.</li> <li>• Movie: For brighter and general movie/video/photo playing.</li> <li>• Dark Cinema: For dark movie content.</li> <li>• Game: For game content.</li> <li>• Game Dark: For game content in a dark environment.</li> <li>• Game Bright: For game content in a bright environment.</li> <li>• Football: For football game.</li> <li>• EcoPro: For extending lamp life.</li> <li>• DICOM SIM: For DICOM format files in simulation mode, and not for actual diagnosis.</li> <li>• ISF Day/ISF Night: Only available when ISF is enabled.</li> <li>• Education: For education environment.</li> <li>• User 1/User 2/User 3: Memorize user's settings.</li> </ul>
<b>Color Profile</b>	<p>Available when User 1/User 2/User 3 is selected in the Display Mode menu. You can use one of the display modes as a starting point and customize the settings. The below OSD items can be adjusted and saved.</p>
<b>Wall Color</b>	<p>Use this function to choose a proper color according to the wall. There are several choices, including White, Light Yellow, Light Blue, Pink and Dark Green. It will compensate for the color deviation due to the wall color to show the correct image tone.</p>

<b>Brightness</b>	<p>Adjusts the brightness of the image.</p> <ul style="list-style-type: none"> <li>• Press ◀ to darken the image.</li> <li>• Press ▶ to lighten the image.</li> </ul>
<b>Contrast</b>	<p>Controls the degree of difference between the lightest and darkest parts of the picture. Adjusting the contrast changes the amount of black and white in the image.</p> <ul style="list-style-type: none"> <li>• Press ◀ to decrease the contrast.</li> <li>• Press ▶ to increase the contrast.</li> </ul>
<b>Saturation</b>	<p>Adjusts a video image from black and white to fully saturated colors.</p> <ul style="list-style-type: none"> <li>• Press ◀ to decrease the amount of color in the image.</li> <li>• Press ▶ to increase the amount of color in the image.</li> </ul>
<b>Tint</b>	<p>Adjusts the color balance of red and green.</p> <ul style="list-style-type: none"> <li>• Press ◀ to increase the amount of green in the image.</li> <li>• Press ▶ to increase the amount of red in the image.</li> </ul>
<b>Color Temperature</b>	<p>Adjusts the color temperature. At higher color temperatures, the screen looks colder; at lower color temperatures, the screen looks warmer.</p>
<b>Gamma</b>	<p>Effects the representation of dark scenery. With greater gamma value, dark scenery will look brighter.</p>







<b>Advanced</b>	<ul style="list-style-type: none"> <li>• Ind. Color Management: Adjusts the red, green, blue, cyan, yellow and magenta colors.</li> <li>• - Ind. Hue: Changes the hue of the color selected.</li> <li>• - Ind. Saturation: Adjusts a video image from black and white to fully saturated color.</li> <li>• - Ind. Gain: Adjusts the contrast levels.</li> <li>• Super Resolution: It is a super-resolution technology which radically enhances Full HD content in terms of colors, contrast, and textures. It's also a Detail Enhancement Technology refines surface details for true-to-life images that pop off the screen. Users can adjust levels of sharpness and detail enhancement for optimal viewing.</li> <li>• Brilliant Color: Produces an expanded on-screen color spectrum that delivers enhanced color saturation for bright, true-to-life images. This feature is "On" by default.</li> <li>• White Peaking: Increases the brightness of whites that are near 100%. (Video sources only)</li> <li>• Film Mode: Sets the image optimized to 24-frame True Film mode for more realistic cadence of film playback during motion sequences.</li> <li>• ISF: This menu is password protected and only accessible by authorized calibrators. The ISF (Imaging Science Foundation) has developed carefully crafted, industry-recognized standards for optimal video performance and has implemented a training program for technicians and installers to use these standards to obtain optimal picture quality ISF certified display devices. Accordingly, we recommend that setup and calibration be performed by an ISF certified installation technician. For more information, go to <a href="http://www.imagingscience.com">www.imagingscience.com</a> or contact the dealer or retailer from whom you purchased the projector.</li> </ul>
<b>Rename</b>	Available when User 1/User 2/User 3 is selected in the Display Mode menu. You can change User 1/User 2/User 3 to your preferred mode name in English letters.









.....

Note: "Saturation" and "Tint" functions are not supported under computer mode.

# Image

<b>Projection Mode</b>	<ul style="list-style-type: none"> <li>•  Front: The factory default setting.</li> <li>•  Rear: Reverses the image so you can project from behind a translucent screen.</li> </ul>
<b>Projection Location</b>	<ul style="list-style-type: none"> <li>•  Auto: Automatically adjusts projection location of image.</li> <li>•  Desktop</li> <li>•  Ceiling: Turns the image upside down for ceiling-mounted projection.</li> </ul>
<b>Aspect Ratio</b>	<p>Use this function to choose your desired aspect ratio.</p> <ul style="list-style-type: none"> <li>• Auto: Keeps the image with original width-height ratio and maximizes the image to fit native horizontal or vertical pixels.</li> <li>• Full (for WXGA/1080p/WUXGA models): The image will be displayed making full use of the horizontal and vertical pixels.</li> <li>• 4:3: The image will be scaled to fit the screen and displayed using a 4:3 ratio.</li> <li>• 16:9: The image will be scaled to fit the screen and displayed using a 16:9 ratio.</li> <li>• L.Box (for WXGA/1080p/WUXGA models): Keeps the original signal aspect ratio and zooms in by 1.333 times.</li> </ul>
<b>H/V Keystone</b>	<p><b>Auto V. Keystone</b> Automatically adjusts vertical image distortion caused by tilting projection (<math>\pm 40</math> degrees).</p> <p><b>V. Keystone</b> Manually adjusts image distortion caused by tilting projection (<math>\pm 30</math> degrees).</p> <div style="text-align: center;">  </div> <p><b>H. Keystone</b> Manually adjusts image distortion caused by tilting projection (<math>\pm 30</math> degrees).</p> <div style="text-align: center;">  </div>

<p><b>Rotation</b></p>	<p>Rotates the projected image.</p> <ul style="list-style-type: none"> <li>• Press ◀ to rotate the image counterclockwise.</li> <li>• Press ▶ to rotate the image clockwise.</li> </ul>
<p><b>4 Corner Correction</b></p>	<p>Manually adjusts the shape and size of an image that is unevenly rectangular on all sides. Press "MODE" repeatedly to select the corner that you wish to adjust. Press four directional selection keys to adjust the image shape.</p>  <p> .....</p> <p>Please adjust 4-corner correction separately for each aspect ratio, and its memory is allowed to save 4 sets of settings only.</p>
<p><b>Warping</b></p>	<p> .....</p> <p><b>Note:</b> Some of the following OSD settings may not be available. Please refer to the actual OSD of your projector.</p> <p>The function is to configure the geometric distortion of the projector's images when the images are projected onto screens which have a kind of uneven surface such as a cylinder, a spherical shape, etc.</p> <p><b>Enable</b> Keystone and corner correction functions will not be available when Warping is enabled.</p> <p><b>Control Method</b> Allows you to select a preferred control method for warping adjustment.</p> <p><b>Warping Adj.</b> This function is available when <b>On</b> is selected in the <b>Warping &gt; Enable</b> menu and <b>OSD</b> is selected in the <b>Warping &gt; Control Method</b> menu.</p>
<p><b>Digital Zoom Out (Install)</b></p>	<p>Sets the default size of the projected image. You can further zooms in or out the image by pressing ◀ ▶ . Using the functions of Digital Zoom Out (Install) and Image Shift together helps you fit the projected image full screen without adjusting the existing ceiling mount settings.</p>



<b>Image Shift</b>	Shifts the projected image by pressing  . When Native Resolution is WUXGA, this functions is only available when the setting of Digital Zoom Out (Install) is less than 1.0.
<b>Sharpness</b>	Adjusts the sharpness of the image. <ul style="list-style-type: none"> <li>• Press  to decrease the sharpness.</li> <li>• Press  to increase the sharpness.</li> </ul>
<b>HDMI Color Range</b>	Adjusts the color range of the HDMI image data to prevent color display error. <ul style="list-style-type: none"> <li>• Auto: Automatically adjusts the color range by information from the player.</li> <li>• Limited Range: Processes the input image as limited color range data.</li> <li>• Full Range: Processes the input image as full color range data.</li> </ul>
<b>HDMI Scan Info</b>	Adjusts the overscan ratio of the HDMI image on screen. <ul style="list-style-type: none"> <li>• Auto: Automatically adjusts the overscan ratio by information from the player.</li> <li>• Underscan: Always no overscan on the HDMI image.</li> <li>• Overscan: Always keep overscan on the HDMI image.</li> </ul>
<b>Silent</b>	When this function is enabled: <ul style="list-style-type: none"> <li>• The acoustic noise will be minimized.</li> <li>• The display resolution will be set at 1920 x 1080.</li> <li>• The COLOR &gt; Picture Mode menu will be automatically changed to Silent and grayed out.</li> </ul>





-----

**Note:** "HDMI Color Range" and "HDMI Scan Info" are only available when the input signal is HDMI.

# Setting

<p><b>HDR</b></p>	<ul style="list-style-type: none"> <li>• <b>HDR:</b> The projector supports HDR imaging sources. It can automatically detect the dynamic range of the source, and optimize settings to reproduce contents under wide range of light conditions. If the input source is not defined with dynamic range, you can also manually select HDR 10 or HLG for it.</li> <li>• <b>EOTF:</b> This function helps provide better image quality with options from low, middle to high.</li> </ul>
<p><b>Startup Screen</b></p>	 ..... <p><b>Note:</b> Some of the following OSD settings may not be available. Please refer to the actual OSD of your projector.</p> <p>Use this function to select your desired startup screen. If you change the setting, it will take effect when you exit the OSD menu.</p> <ul style="list-style-type: none"> <li>• <b>Acer:</b> The default startup screen of your Acer projector.</li> <li>• <b>User:</b> Use the picture you transfer to the projector. See "Acer Splash Downloader" for how to transfer the picture.</li> </ul>
<p><b>USB Mode Switch</b></p>	<ul style="list-style-type: none"> <li>• <b>Control:</b> When selected, you can use the page up/page down function via the USB port. Firmware can also be updated via the USB port for service personnel.</li> <li>• <b>Adaptor:</b> When selected, the USB port can only output power for Chromecast 4.</li> </ul>
<p><b>Source Selection</b></p>	<ul style="list-style-type: none"> <li>• <b>Manual:</b> When switching input signals, you need to press "SOURCE" on the control panel or remote control, or the direct source key on the remote control.</li> <li>• <b>Auto:</b> The projector will detect your source automatically.</li> </ul>
<p><b>USB 5V (Standby)</b></p>	<p>Selecting "On" enables the function. The MHL port(s) and the DC 5V out port/USB A port (if available) on the projector can output 5V power when the projector is turned on.</p>  ..... <p>Only MHL port(s) will provide power output when MHL port(s) and USB A port are both plugged.</p>



<b>HDMI CEC</b>	<p>Selecting "On" allows synchronized power ON/OFF operation between the projector and a CEC-compatible device connected to the HDMI/MHL port of the projector.</p>  <p>-----</p> <p>This function is only available for the HDMI/MHL port.</p>
<b>Low Input Lag</b>	<p>This function is especially suitable for gaming environment. It reduces input to output latency and helps create a seamless experience.</p>  <p>-----</p> <p>This function is only available for certain input timings. After turned on, performing Auto Keystone or adjusting the following settings will deactivate this function: Aspect ratio, Keystone, H. Position, V. Position, Frequency, HDMI Scan Info, Digital Zoom. When Display Mode is Game Dark or Game Bright, this function will be automatically turned on.</p>
<b>Reset</b>	<p>Press "ENTER" after choosing "Yes" to return the display parameters on all menus to the factory default settings.</p>

# Management

<p><b>ECO Mode</b></p>	<p>Choose "ECO", "EcoPro" or "Dynamic Black" to dim the projector lamp, which will also lower the power consumption, reduce noise, and extend the lamp life. ("EcoPro" makes the lamp last longer.) Choose "Off" to return to the normal mode.</p> <p> -----</p> <p>When "off" is selected, once the ambient temperature reaches 35°C, "ECO" will be activated automatically. After the ambient temperature drops below 32°C, the previous selection will be activated.</p>
<p><b>High Altitude</b></p>	<p>Choose "On" to turn on the High Altitude mode. When this function is turned on, the projector fans operate at full speed continuously to cool down the projector's temperature.</p>
<p><b>Turn Off Mode</b></p>	<ul style="list-style-type: none"> <li>• Standard: Enables you to turn off the projector with fan cooling process by pressing the power button twice.</li> <li>• Instant Resume: Enables you to restart the projector immediately within 2 minutes after turning it off.</li> </ul>
<p><b>Auto Shutdown (Minutes)</b></p>	<p>The projector will automatically shut down while there is no signal input detected after the time you set.</p>
<p><b>Menu Display Time (Seconds)</b></p>	<ul style="list-style-type: none"> <li>• 5/15/30: Chooses the length of time the OSD menu will remain active after your last key press.</li> <li>• Manual: The OSD menu remains active. The only way to launch or exit the OSD menu is by pressing "MENU".</li> </ul>
<p><b>Auto Power On</b></p>	<p><b>AC Power On</b> Selecting "On" enables the function. The projector will automatically turn on when power is supplied via the power cord.</p> <p><b>HDMI Power On</b> Selecting "On" enables the function. The projector will automatically turn on when power is supplied via the power cord and the HDMI signal is supplied via the HDMI cable.</p>

<b>Control Panel Lock</b>	<ul style="list-style-type: none"> <li>• Off: Allows all keys on the control panel to operate normally.</li> <li>• Child Lock: Disables the Power key on the control panel when the projector is in standby mode to prevent it from being accidentally turned on. To turn the projector on, press and hold the Power key for 3 seconds.</li> <li>• Full Lock: Disables all keys on the control panel. If you turn off the projector without disabling the Full Lock function, the projector will still be in locked status the next time it is turned on. To disable Full Lock function, press and hold "POWER" on the control panel for 7 seconds and the Control Panel Lock will be set to "Off". When the projector is in standby mode, press and hold "POWER" on the control panel for 7 seconds to turn the projector on and the Control Panel Lock will be set to "Off".</li> </ul>
<b>Lamp</b>	<ul style="list-style-type: none"> <li>• Lamp Hour Elapse: Displays the lamp's elapsed operating time (in hours).</li> <li>• Lamp Reminding: Choose this function to show or hide warning message when the changing lamp message is displayed. The message will show up 30 hours before end of life.</li> <li>• Lamp Hour Reset: Press "ENTER" after choosing "Yes" to reset the lamp hour counter to 0 hours.</li> </ul>
<b>Information</b>	Displays current status of this projector.

# Audio

<b>Volume</b>	<ul style="list-style-type: none"> <li>• Press ◀ to decrease the volume.</li> <li>• Press ▶ to increase the volume.</li> </ul>
<b>Mute</b>	<ul style="list-style-type: none"> <li>• Choose "On" to turn mute on.</li> <li>• Choose "Off" to turn mute off.</li> </ul>
<b>Power On/Off Volume</b>	Select this function to adjust the notification volume when turning the projector on/off.
<b>Alarm Volume</b>	Select this function to adjust the volume of any warning notifications.
<b>Audio Output</b>	<p>You can select the audio output from internal or external speakers.</p>  <p>.....</p> <p>To enjoy Audio Return sound effect, make sure to turn on the eARC/ARC function from your soundbar as well. Audio Return supports multi-audio outputs including 2.0, 5.1, 7.1 and Dolby Atmos to external audio system like soundbar.</p>
<b>Audio Format</b>	<p>This function provides different audio output formats to achieve the audio performance you desire.</p> <ul style="list-style-type: none"> <li>• LPCM: Supports 2 channel audio output.</li> <li>• Multi-channel: Supports 5.1 channel audio output.</li> <li>• Multi-channel+: Supports Dolby Atmos audio output.</li> </ul>



.....

**Note:** When audio output or audio format changes, image will re-sync.

**Note:** Internal speaker supports 2 channel LPCM format. Other audio outputs and formats will be bypassed out.

**Note:** Only "Multichannel+" format bypasses 192KHz audio to eARC receivers. Please make sure that 192KHz audio is supported by the audio receiver.

## 3D

3D	<p>Selects "On" to enable the 3D function supported by DLP 3D technology.</p> <ul style="list-style-type: none"> <li>On: Select this item while using DLP 3D glasses, quad buffer (NVIDIA/ATI...) graphics card and HQFS format file or DVD with corresponding SW player.</li> <li>Off: Turns off the 3D mode.</li> </ul>
3D Format	<p>If the 3D content is not displayed correctly, you can select a 3D format that suits the 3D content you are viewing and obtain the best result.</p>
24P 3D	<p>Choose 96Hz or 144Hz for 24p 3D.</p>
3D L/R Invert	<p>If you see a discrete or overlapping image while wearing DLP 3D glasses, you may need to execute "Invert" to get best match of left/right image sequence to get the correct image (for DLP 3D).</p>
3D Warning Message	<p>Choose "On" to display the 3D warning message.</p> <div data-bbox="363 651 918 799" style="background-color: black; color: white; padding: 10px;"> <p>Note: 3D display is now enabled.</p> <ol style="list-style-type: none"> <li>1. Please make sure you have the correct 3D signals and glasses.</li> <li>2. Remember to turn off 3D if you don't want to see 3D images.</li> <li>3. If the 3D display isn't correct, please try to enable 3D L/R Invert.</li> <li>4. Display mode options will be disabled while in 3D mode.</li> </ol> </div>



**Note:** For supported 3D signal timings, please find the 3D support document.

It needs correct settings on graphics card 3D application program for correct 3D display.

**Note:** "3D L/R Invert" and "3D Format" are only available when "3D" is enabled.

## Language

Language	<p>Sets a language for the OSD menus. Use ▲ ▼ to select your preferred language.</p>
----------	--

# Acer Splash Downloader

## Introduction

Acer Splash Downloader allows you to upload your desired picture onto an Acer projector. You can select the picture as the startup screen via the projector's OSD menu.

## System Requirements

Maximum image size	3 Mbytes
Maximum image resolution	1920 x 1200 Recommended: Native resolution
Minimum image resolution	800 x 600
Maximum color bits	24 bits
Image format	BMP, JPG, PNG
Supported operation system	Windows 7, 8, 8.1, 10 (32 / 64 Bit)

## Using the Acer Splash Downloader

### 1. Entering download mode

Long press the POWER and MENU buttons on the control panel simultaneously while plugging in the power cord until the LED indicator lights up red.

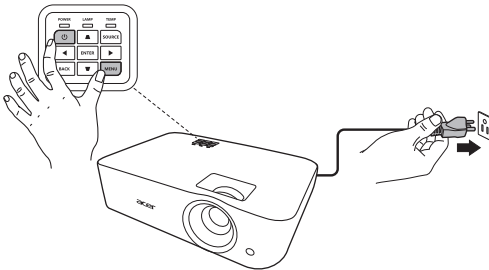

## 2. Connecting the computer to the projector

Use an USB cable to connect the computer and the projector.

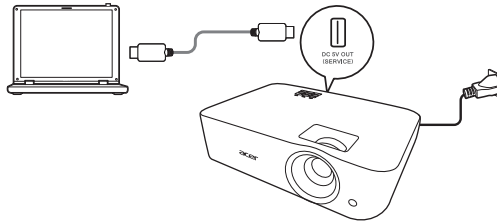

## 3. Executing the Acer Splash Downloader tool on the computer

If the projector is not properly connecting to the computer, below message will be displayed.

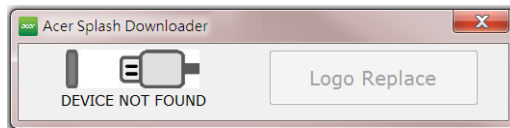

If the projector successfully connects the computer, below message will be displayed. Press "Logo Replace" to proceed.

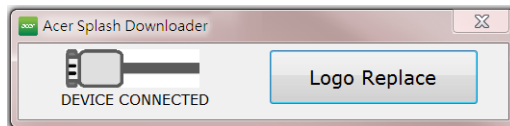

## 4. Loading the image



**Note:** Some of the following OSD settings may not be available. Please refer to the actual OSD of your projector.

First, select the native resolution for the projector by adjusting "PJ Native Resolution" and decide if you want the image to be displayed full screen or in its original aspect ratio.

Press "LoadImage" and choose an image from your computer.

If the image is loaded successfully, the tool status will display "Load Image successfully".

"Setting changed!! Please load image again." will be displayed in the tool status when PJ Native Resolution or aspect ratio is adjusted after the image is loaded successfully.

"Image size is over defined range" will be displayed in the tool status when the image is too large, and "Load Image fail" will be displayed when the image format is not supported.

## 5. Downloading the image to the projector

Press "Download" to start downloading the image to the projector.



.....  
**Note:** If "Unknown" is shown in the Manufacture or Device ID field, the projector is not in a status suitable for download. Go back to step 1 and try again.

After the image is downloaded successfully, the projector will automatically shut down (enter standby mode), and the Startup Screen function in the OSD menu will be set to "User".



# Appendices

## Troubleshooting

If you experience a problem with your Acer projector, refer to the following troubleshooting guide. If the problem persists, please contact your local reseller or service center.

### Image Problems and Solutions

#	Problem	Solution
1	No image appears onscreen	<ul style="list-style-type: none"> <li>• Make sure all the cables are correctly connected as described in the "Getting Started" section.</li> <li>• Ensure none of the connector pins are bent or broken.</li> <li>• Make sure the projector is switched on.</li> </ul>
2	Partial, scrolling or incorrectly displayed image (For PC)	<ul style="list-style-type: none"> <li>• For an incorrectly displayed image:           <ul style="list-style-type: none"> <li>• Open "My Computer &gt; Control Panel," and then double-click the "Display" icon.</li> <li>• Select the "Settings" tab.</li> <li>• Verify that your display resolution setting is lower than or equal to 1600 x 1200 or 1920 x 1080.</li> <li>• Click the "Advanced Properties" button.</li> </ul> </li> <li>• If the problem still appears, change the monitor display you are using and follow the steps below:           <ul style="list-style-type: none"> <li>• Verify that the resolution setting is lower than or equal to 1600 x 1200 or 1920 x 1080.</li> <li>• Click the "Change" button under the "Monitor" tab.</li> <li>• Click "Show all devices &gt; Standard monitor types" under the SP box, and choose the resolution mode you need under the "Models" box.</li> <li>• Verify that the resolution setting of the monitor display is lower than or equal to 1600 x 1200 or 1920 x 1080.</li> </ul> </li> </ul>

3	Partial, scrolling or incorrectly displayed image (For notebooks)	<ul style="list-style-type: none"> <li>• For an incorrectly displayed image:             <ul style="list-style-type: none"> <li>• Follow the steps for item 2 (above) to adjust the resolution of your computer.</li> <li>• Press the toggle output settings. Example: [Fn]+[F4], Compaq [Fn]+[F4], Dell [Fn]+[F8], Gateway [Fn]+[F4], IBM [Fn]+[F7], HP [Fn]+[F4], NEC [Fn]+[F3], Toshiba [Fn]+[F5]</li> </ul> </li> <li>• If you experience difficulty changing resolutions or your monitor freezes, restart all equipment including the projector.</li> </ul>
4	The screen of the notebook computer is not displaying your presentation	<ul style="list-style-type: none"> <li>• If you are using a Microsoft® Windows® based notebook: Some notebook PCs may deactivate their own screens when a second display device is in use. Each has a different way to be reactivated. Refer to your computer's manual for detailed information.</li> <li>• If you are using an Apple® Mac® OS based notebook: In System Preferences, open Display and select Video Mirroring "On."</li> </ul>
5	Image is unstable or flickering	<ul style="list-style-type: none"> <li>• Change the display color setting on your computer.</li> </ul>
6	Image has vertical flickering bar	<ul style="list-style-type: none"> <li>• Check and reconfigure the display mode of your graphics card to make it compatible with the projector.</li> </ul>
7	Image is out of focus	<ul style="list-style-type: none"> <li>• Adjust the focus ring on the projector lens.</li> <li>• Make sure the projection screen is within the required distance. Refer to the "How to Get a Preferred Image Size by Adjusting Distance and Zoom" section for more information.</li> </ul>
8	Image is stretched when displaying a "widescreen" DVD title	<p>When you play a DVD encoded in anamorphic or 16:9 aspect ratio you may need to adjust the following settings:</p> <ul style="list-style-type: none"> <li>• If you play a 4:3 format DVD title, please change the format to 4:3 with the projector OSD.</li> <li>• If the image is still stretched, you will also need to adjust the aspect ratio. Set up the display format to 16:9 (wide) aspect ratio on your DVD player.</li> </ul>
9	Image is too small or too large	<ul style="list-style-type: none"> <li>• Adjust the zoom lever on the top of the projector.</li> <li>• Move the projector closer to or further from the screen.</li> <li>• Press "MENU" on the control panel or remote control. Go to "Image" &gt; "Aspect Ratio" and try different settings.</li> </ul>

10	Image has slanted sides	<ul style="list-style-type: none"> <li>• If possible, reposition the projector so that it is centered on the screen and below the bottom of the screen.</li> <li>• Press the Keystone correction keys on the control panel or remote control until the image becomes square.</li> <li>• Press "MENU" on the control panel or remote control to open the OSD menu. Go to "Image" &gt; "H/V Keystone" to make adjustments.</li> </ul>
11	Image is reversed	<ul style="list-style-type: none"> <li>• Select "Image" &gt; "Projection Mode", "Image" &gt; "Projection Location" on the OSD and adjust the projection direction.</li> </ul>

## Problems with the Projector

#	Condition	Solution
1	The projector stops responding to all controls	<ul style="list-style-type: none"> <li>• If possible, turn off the projector, then unplug the power cord and wait at least 30 seconds before reconnecting power.</li> <li>• Make sure that the control panel lock function is disabled.</li> </ul>
2	Lamp burns out or makes a popping sound	When the lamp reaches the end of its useful life, it will burn out and may make a loud popping sound. If this happens, the projector will not turn on until the lamp module has been replaced. To replace the lamp, contact your local dealer or Acer service center.

## OSD Messages

#	Condition	Message Reminder
1	Message	<p data-bbox="369 277 711 300">Fan Fail - the system fan is not working.</p> <div data-bbox="369 304 910 373" style="background-color: black; color: white; padding: 5px; text-align: center;"> <p data-bbox="609 316 670 335">Fan Fail.</p> <p data-bbox="500 339 779 359">Lamp will automatically turn off soon.</p> </div> <p data-bbox="369 387 906 451">Projector Overheated - the projector has exceeded its recommended operating temperature and must be allowed to cool down before it is used.</p> <div data-bbox="369 459 910 528" style="background-color: black; color: white; padding: 5px; text-align: center;"> <p data-bbox="558 470 721 489">Projector Overheated.</p> <p data-bbox="500 494 779 513">Lamp will automatically turn off soon.</p> </div> <p data-bbox="369 533 877 579">Replace the lamp - the lamp is about to reach its maximum lifetime. Prepare to replace it soon.</p> <div data-bbox="369 587 910 655" style="background-color: black; color: white; padding: 5px; text-align: center;"> <p data-bbox="380 595 899 614">Lamp is approaching the end of its useful life in full power operation.</p> <p data-bbox="550 619 729 638">Replacement suggested!</p> </div>

# LED & Alarm Definition Listing

## LED Messages

Message	Power LED		LAMP LED	TEMP LED
	Red	Blue	Red	Red
Standby (Power cord plugged in)	V	--	--	--
Power on	--	V	--	--
Lamp retry	--	Quick flashing	--	--
Turning off (Cooling state)	Quick flashing	--	--	--
Turning off (Cooling completed)	V	--	--	--
Firmware download	V	--	V	V
Acer splash download	V	--	V	V
Error (Thermal failure)	--	V	--	V
Error (Fan lock failure)	--	V	--	Quick flashing
Error (Lamp breakdown)	--	V	V	--
Error (Color wheel failure)	--	V	Quick flashing	--

## Ceiling Mount Installation

If you wish to install the projector using a ceiling mount, please refer to the steps below:

- 1 Drill four holes into a solid, structurally sound part of the ceiling, and secure the mount base.

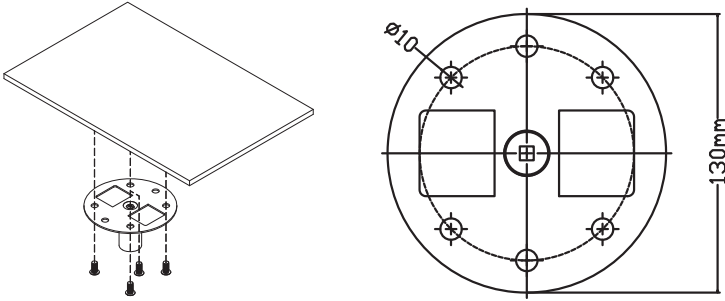

- 2 Choose the length combination based on actual environment. (CM-01S doesn't include Type 2 and Type 3.)

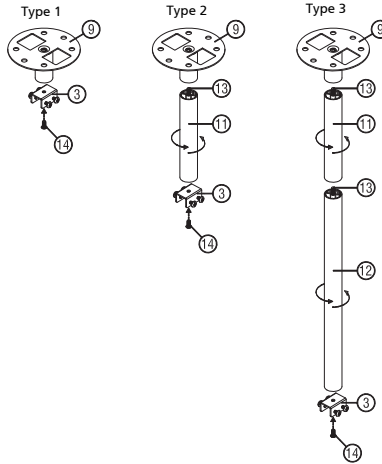

- 3 Type 1: For the standard size use three bracket screws to mount the projector to the ceiling mount bracket.

Type 2 and Type 3: Alternatively, for the larger size, use the sliding extensions for more supports.

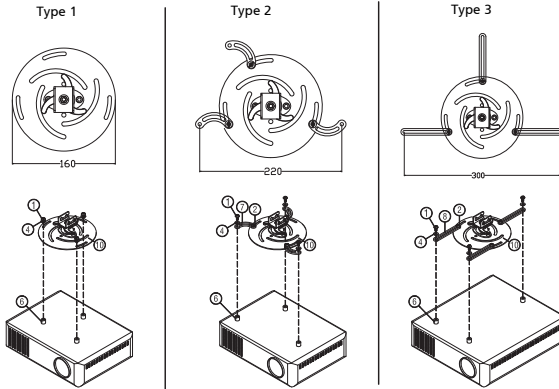

**Note:** It is recommended that you keep a reasonable space between the bracket and the projector to allow for proper heat distribution.

- 4 Connect the main body connector to the projector bracket (illustration 1), and then screw up four screws (illustration 2).

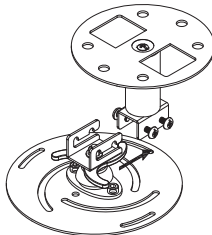

Illustration 1

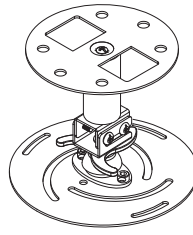
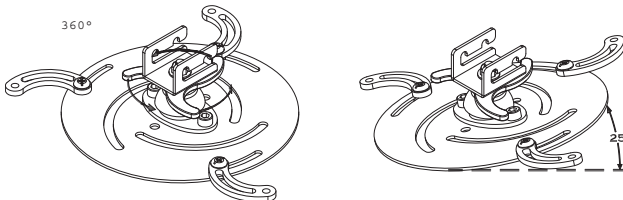
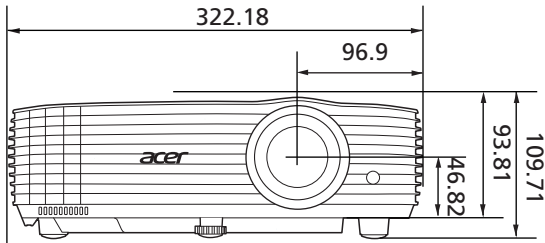
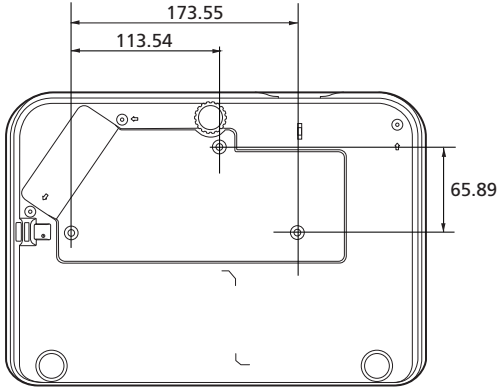

Illustration 2

- 5 Adjust the angle and positioning as necessary.



Screw Type B		Washer Type	
Diameter (mm)	Length (mm)	Large	Small
4	25	V	V



Unit: mm



## Specifications

The specifications below are subject to change without notice. For final specs, please refer to Acer's marketing documentation.

Projection system	DLP™
Computer compatibility	Refer to the "Compatibility Modes" section for more information.
Video compatibility	NTSC (3.58/4.43), PAL (M/N), PAL 60, SECAM, HDTV (720p, 1080i, 1080p), EDTV (480p, 576p), SDTV (480i, 576i)
Displayable colors	1.07 billion colors
Digital zoom	0.8 – 2 X
Weight	Approximate 2.6 kg (5.73 lbs.)
Dimensions (W x D x H)	322 x 225 x 93.8 mm (12.7" x 8.6" x 3.7") 322 x 225 x 109.7 mm (12.7" x 8.6" x 4.3") (with tilt adjusting wheels)
Power supply	Universal AC input 100 - 240 V, input frequency 50/60 Hz
Operating temperature	0°C to 40°C / 32°F to 104°F
Standard package contents	<ul style="list-style-type: none"> <li>• AC power cord x 1</li> <li>• Remote control x 1</li> <li>• Battery x 2 (for the remote control)</li> <li>• Quick start guide x 1</li> </ul>
Accessory (optional)	<ul style="list-style-type: none"> <li>• VGA cable x 1</li> <li>• HDMI cable x 1</li> <li>• Security card x 1</li> <li>• Carrying case x 1</li> <li>• WirelessHD dongle kit (MWIHD1) x 1</li> <li>• WirelessCAST x 1</li> <li>• WirelessProjection-Kit x 1</li> </ul>

## H6815/E8615/HE-4K15/GM835/VH-736/H6815BD+/H6815ABD/ H6815BD/H6815+/H6815A/H6822BD

Resolution	Native: 3840 x 2160 Maximum: 3840 x 2160
Aspect ratio	Auto, 4:3, 16:9, Full, L.Box
Projection lens	F = 2.0 – 2.05, f = 15.843 mm – 17.445 mm, 1:1.1 Manual Zoom and Manual Focus
Projection screen size (diagonal)	55" – 300" (139 cm – 762 cm)
Projection distance	2.0 – 10.0 m
Throw ratio	1.5 – 1.65:1 (60" ± 3% @ 2 m)
Horizontal scan rate	15 – 100 KHz
Vertical refresh scan rate	24 – 120 Hz
Keystone correction	+/-40 Degrees (Vertical), Manual & Auto
Audio	3W speaker x 1
Power consumption	Standard mode: 270 W @100 VAC ECO mode: 210 W @ 100 VAC Standby mode: < 0.5 W

## H6830BD/E8630/HE-4K30/GM835Z/VH-736Z/H6830BDZ+/ H6831BD/H6830BD+/H6830

Resolution	Native: 3840 x 2160 Maximum: 3840 x 2160
Aspect ratio	Auto, 4:3, 16:9, Full, L.Box
Projection lens	F = 1.94 – 2.12, f = 11.9 mm – 15.5 mm, 1:1.3 Manual Zoom and Manual Focus
Projection screen size (diagonal)	50" – 300" (127 cm – 762 cm)
Projection distance	1.0 – 9.8 m
Throw ratio	1.127 – 1.46 (95" ± 3% @ 2.37 m)
Horizontal scan rate	15 – 135 KHz
Vertical refresh scan rate	24 – 240 Hz
Keystone correction	+/-40 Degrees (Vertical), Manual & Auto
Audio	10W speaker x 1
Power consumption	Standard mode: 310 W @100 VAC ECO mode: 220 W @ 100 VAC Standby mode: < 0.5 W

I/O connectors	H6815/E8615/HE-4K15/GM835/VH-736/H6815BD+/H6815ABD/H6815BD/H6815+/H6815A/H6822BD	H6830BD/E8630/HE-4K30/GM835Z/VH-736Z/H6830BDZ+/H6831BD/H6830BD+/H6830
Power socket	V	V
DC 5V OUT (SERVICE)	V	V
VGA IN 1	-	-
VGA IN 2	-	-
VGA OUT	-	-
RS232	V	V
AUDIO IN	-	-
AUDIO OUT	V	V
HDMI 1	V	V
HDMI 2	V	-
HDMI 2 (AUDIO RETURN)	-	V
S/PDIF	-	V
VIDEO	-	-

\* Design and specifications are subject to change without notice.

# Compatibility Modes

## 1 HDMI - PC Signal

Mode	Resolution	V.Frequency [Hz]	H.Frequency [KHz]
VGA_60	640 x 480	59.94	31.469
VGA_72		72.809	37.861
VGA_75		75	37.5
VGA_85		85.008	43.269
VGA_120		119.518	61.91
SVGA_56	800 x 600	56.25	35.156
SVGA_60		60.317	37.879
SVGA_72		72.188	48.077
SVGA_75		75	46.875
SVGA_85		85.061	53.674
SVGA_120		119.854	77.425
XGA_60	1024 x 768	60.004	48.363
XGA_70		70.069	56.476
XGA_75		75.029	60.023
XGA_120		119.804	98.958
SXGA_75	1152 x 864	75	67.5
SXGA_85		84.99	77.094
SXGA_60	1280 x 1024	60.02	63.981
SXGA_72		72	76.97
SXGA_75		75.025	79.976
SXGA_85		85.024	91.146
QuadVGA_75	1280 x 960	75	75
SXGA+_60	1400 x 1050	59.978	65.317
UXGA_60	1600 x 1200	60	75
Mac G4	640 x 480@60Hz	59.94	31.469
MAC13	640 x 480@67Hz	66.667	35
Mac G4	800 x 600@60Hz	60.317	37.879
Mac G4	1024 x 768@60Hz	60.004	48.363
MAC19	1024 x 768@75Hz	75.02	60.241
MAC21	1152 x 870@75Hz	75.061	68.681
WXGA_60	1280 x 768	59.87	47.776
WXGA_75		74.893	60.289
WXGA_85		84.837	68.633
WXGA_60	1280 x 720	60	45

WXGA_60	1280 x 800	59.81	49.702
WXGA_120-RB	1280 x 800	119.909	101.563
WXGA+_60	1440 x 900	59.887	55.935
1680x1050_60	1680 x 1050	59.954	65.29
acer_16:9	1366 x 768	59.79	47.712
1920 x 1080_RB	1920 x 1080	60	66.587
1920 x 1080_EIA	1920 x 1080	60	67.5
1920 x 1080_120	1920 x 1080	119.982	137.260
1920 x 1080_240	1920 x 1080	239.76	291.309
acer_timing	1024 x 600	60	37.5
1920 x 1200-RB	1920 x 1200	59.95	74.038
3840 x 2160_24	3840 x 2160	24	54
3840 x 2160_25		25	56.25
3840 x 2160_30		30	67.5
3840 x 2160_50		50	112.5
3840 x 2160_60		60	135

## 2 HDMI - Video Signal

Mode	Resolution	V.Frequency [Hz]	H.Frequency [KHz]
480i	720 x 480 (1440 x 480)	60	15.73
480p	720 x 480	60	31.47
576i	720 x 576 (1440 x 576)	50	15.63
576p	720 x 576	50	31.25
720p	1280 x 720	60	45.00
720p	1280 x 720	50	37.50
1080i	1920 x 1080	60	33.75
1080i	1920 x 1080	50	28.13
1080p	1920 x 1080	60	67.50
1080p	1920 x 1080	50	56.26
1080p	1920 x 1080	24	27.00
1080p	1920 x 1080	23.98	26.97
1080p	1920 x 1080	30	33.75
2160/24P	3840 x 2160	24	54
2160/25P	3840 x 2160	25	56.25
2160/30P	3840 x 2160	30	67.5
2160/50P	3840 x 2160	50	112.5
2160/60P	3840 x 2160	60	135

# Regulations and safety notices

## FCC notice

This device has been tested and found to comply with the limits for a Class B digital device pursuant to Part 15 of the FCC rules. These limits are designed to provide reasonable protection against harmful interference in a residential installation. This device generates, uses, and can radiate radio frequency energy and, if not installed and used in accordance with the instructions, may cause harmful interference to radio communications.

However, there is no guarantee that interference will not occur in a particular installation. If this device does cause harmful interference to radio or television reception, which can be determined by turning the device off and on, the user is encouraged to try to correct the interference by one or more of the following measures:

- Reorient or relocate the receiving antenna.
- Increase the separation between the device and receiver.
- Connect the device into an outlet on a circuit different from that to which the receiver is connected.
- Consult the dealer or an experienced radio/television technician for help.

## Notice: Shielded cables

All connections to other computing devices must be made using shielded cables to maintain compliance with FCC regulations.

## Notice: Peripheral devices

Only peripherals (input/output devices, terminals, printers, etc.) certified to comply with the Class B limits may be attached to this equipment. Operation with non-certified peripherals is likely to result in interference to radio and TV reception.

## Caution

Changes or modifications not expressly approved by the manufacturer could void the user's authority, which is granted by the Federal Communications Commission, to operate this device.

## Operation conditions

This device complies with Part 15 of the FCC Rules. Operation is subject to the following two conditions: (1) this device may not cause harmful interference, and (2) this device must accept any interference received, including interference that may cause undesired operation.

## Notice: Canadian users

This Class B digital apparatus complies with Canadian ICES-003.

## Remarque à l'intention des utilisateurs canadiens

Cet appareil numérique de la classe B est conforme à la norme NMB-003 du Canada.

Compliant with Russian/Ukraine/Belarus/Morocco regulatory certification



## Radio device regulatory notice



**Note:** The regulatory information below is for models with wireless LAN and/or Bluetooth only.

### General

This product complies with the radio frequency and safety standards of any country or region in which it has been approved for wireless use. Depending on configurations, this product may or may not contain wireless radio devices (such as wireless LAN and/or Bluetooth modules).

### Canada — Low-power license-exempt radio communication devices (RSS-247)

- a Common information  
Operation is subject to the following two conditions:
  1. This device may not cause interference, and
  2. This device must accept any interference, including interference that may cause undesired operation of the device.
- b Operation in 2.4 GHz band  
To prevent radio interference to the licensed service, this device is intended to be operated indoors and installation outdoors is subject to licensing.

### List of applicable countries

This device must be used in strict accordance with the regulations and constraints in the country of use. For further information, please contact a local office in the country of use. Please see <http://ec.europa.eu/enterprise/rtte/implem.htm> for the latest country list.



Acer Incorporated  
8F, 88, Sec. 1, Xintai 5th Rd., Xizhi  
New Taipei City 221, Taiwan

## EU Declaration of Conformity

We,  
**Acer Incorporated**  
8F, 88, Sec. 1, Xintai 5th Rd., Xizhi, New Taipei City 221, Taiwan

And,  
**Acer Italy s.r.l**  
Viale delle Industrie 1/A, 20044 Arese (MI), Italy  
Tel: +39-02-939-921, Fax: +39-02-9399-2913  
www.acer.it

**Product:** DLP Projector  
**Trade Name:** Acer  
**Model Number:** A4K2008/A4K2111  
**SKU Number:** H6815/E8615/HE-4K15/GM835/VH-736/H6815BD+/  
H6815ABD/H6815BD/H6815+/H6815A/  
H6830BD/E8630/HE-4K30/GM835Z/VH-736Z/  
H6830BDZ+/H6831BD/H6830BD+/H6830

We, Acer Incorporated, hereby declare under our sole responsibility that the product described above is in conformity with the relevant Union harmonization legislations as below Directive and following harmonized standards and/or other relevant standards have been applied:

<input checked="" type="checkbox"/> <b>EMC Directive: 2014/30/EU</b>		
<input checked="" type="checkbox"/> EN 55032:2015+A11:2020,Class B	<input checked="" type="checkbox"/> EN 61000-3-2:2014	<input checked="" type="checkbox"/> EN 61000-3-3:2013
<input checked="" type="checkbox"/> EN 55024:2010+A1:2015	<input checked="" type="checkbox"/> EN 55035:2017+A11:2020	
<input checked="" type="checkbox"/> <b>LVD Directive: 2014/35/EU</b>		
<input checked="" type="checkbox"/> EN 62368-1:2014+A11:2017	<input checked="" type="checkbox"/> EN IEC 62368-1:2020+A11:2020	
<input checked="" type="checkbox"/> <b>RoHS Directive: 2011/65/EU</b>		
<input checked="" type="checkbox"/> EN 50581:2012		
<input checked="" type="checkbox"/> <b>ErP Directive: 2009/125/EC</b>		
<input type="checkbox"/> Regulation (EU) No. 617/2013	<input type="checkbox"/> Regulation (EU) No. 2019/1782; EN 50563:2011	
<input checked="" type="checkbox"/> Regulation (EC) No. 1275/2008; EN 50564:2011		

Year to begin affixing CE marking 2022.

  
RU Jan/Sr. Manager  
Acer Incorporated (Taipei, Taiwan)

Apr. 21, 2022  
Date



**Acer America Corporation**

333 West San Carlos St.,

Suite 1500

San Jose, CA 95110

U. S. A.

Tel: 254-298-4000

Fax: 254-298-4147

[www.acer.com](http://www.acer.com)

## Federal Communications Commission Declaration of Conformity

This device complies with Part 15 of the FCC Rules. Operation is subject to the following two conditions: (1) this device may not cause harmful interference, and (2) this device must accept any interference received, including interference that may cause undesired operation.

The following local Manufacturer /Importer is responsible for this declaration:

Product:	DLP Projector
Model Number:	A4K2008/A4K2111
SKU Number:	H6815/E8615/HE-4K15/GM835/VH-736/ H6815BD+/H6815ABD/H6815BD/ H6815+/H6815A/H6830BD/E8630/HE- 4K30/GM835Z/VH-736Z/H6830BDZ+/ H6831BD/H6830BD+/H6830 series
Name of Responsible Party:	Acer America Corporation
Address of Responsible Party:	333 West San Carlos St. Suite 1500 San Jose, CA 95110 U. S. A.
Contact Person:	Acer Representative
Phone No.:	254-298-4000
Fax No.:	254-298-4147