

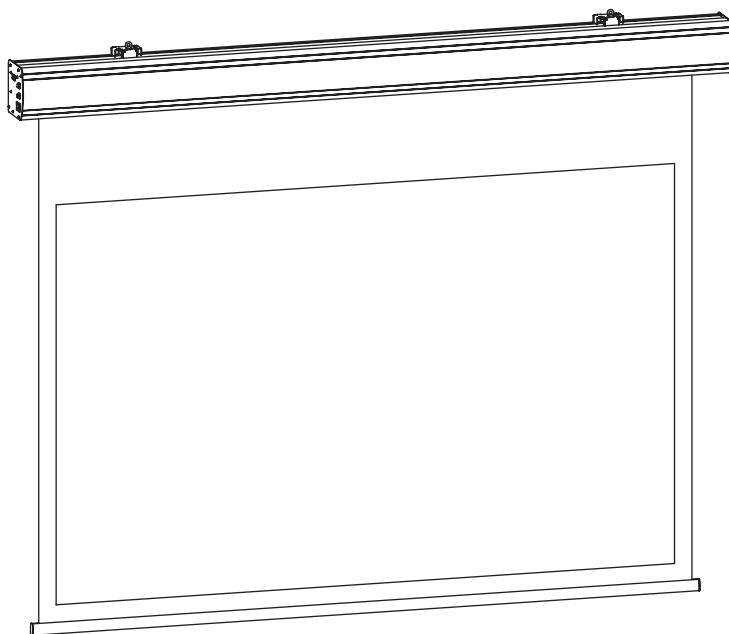

User manual

DELUXX Cinema Electric Screen (Tension)



Thank you for choosing a quality DELUXX product. Please read this manual carefully before using the screen and keep it in a safe place.

DE:

Auf <http://www.deluxx.com/downloads> finden Sie die aktuelle Version dieser Bedienungsanleitung zum Download.

EN:

Please visit <http://www.deluxx.com/downloads> for the latest version of this manual.

FR:

Veuillez visiter <http://www.deluxx.com/downloads> pour obtenir la dernière version du manuel d'utilisation.

NL:

Op <http://www.deluxx.com/downloads> vindt u de meest actuele download versie van de bedieningshandleiding.

SE:

Under <http://www.deluxx.com/downloads> hittar du och kan ladda ner den aktuella versionen av din bruksanvisning.

PL:

Na stronie <http://www.deluxx.com/downloads> znajdą Państwo aktualną wersję instrukcji obsługi.

ES:

Visite <http://www.deluxx.com/downloads> para obtener la última versión de este manual.

IT:

La versione aggiornata del manuale d'istruzioni è presente alla pagina <http://www.deluxx.com/downloads>.

Safety instructions

- Please read the enclosed data sheet with further safety and usage instructions before installation.
- Do not start assembly before completely reading and understanding the manual.
- This product should only be installed by qualified personnel with mechanical and electrical know-how.
- Carry out the installation with another person to ensure safe installation.
- Tighten the screws, but do not overtighten them as over tightening may cause damage and affect the secure hold of the screen.
- This product is intended for indoor use. Outdoor use could damage the product.

Safety instructions

- Hanging loads must be tested at least twice a year for strength and load-bearing capacity.
- Use the product and all accessories only as intended.
- Children should not use the screen unattended or play underneath.

Attention

Please read the following instructions carefully and keep them for future reference. The manufacturer assumes no responsibility for damage to property or personal injury when the screen is used outside the recommended specifications, or in the case of improper installation.

Do not use this screen near heaters or air conditioners. Also, do not mount the product in direct sunlight or in front of a window. Due to the temperature-sensitive PVC surface, it can lead to lasting damage to the projection screen.

We recommend that you wait approx. 2 hours after delivery for the assembly so that the fabric can acclimatize; especially when the screen is brought from cold to warm surroundings.

Please avoid any stains on the cloth surface. These may not be removable.

The positions of the endpoints are already optimally set at the factory and should not be changed. Especially with Tension screens, the entire length of the fabric should always be used to ensure the best flatness. An adjustment of a few cm of the end stop points should only be made by persons with specialist knowledge and / or in consultation with the manufacturer. An incorrect setting may damage the screen.

Care Instructions

NEVER clean the screen with alcohol or other detergents that contain solvents. Use only a soft and clean cloth with a mild soapy water, if necessary to remove dirt from the surface. Be sure to avoid contact with sharp objects. These could permanently damage the projection screen fabric.

In the box

Please check before beginning installation that all following parts are included! If any parts are missing, contact the dealer where you purchased the product and wait to receive them before completing the installation.

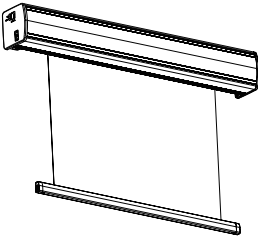

a) 1x screen

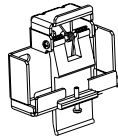

b) 2x Mounting bracket

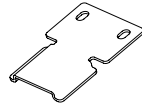

c) 2x Ceiling mounting adapter

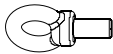

d) 2x Eyelet



e) 2x Hook anchors
(for screens up to 135")



f) 2x M6 ceiling hook plate
(for screens from 135")



g) 4x Universal screw
5x40mm



h) 4x Plastic wall plugs
8mm



i) 2x Hexagon nut

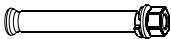

j) 4x Heavy Duty Dowel

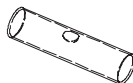

k) 1x Spirit Level



l) 2x Remote control
(1 x Infrared, 1 x Radio)

Lieferumfang



m) 2x Carabiner



n) 1x Stop adjuster

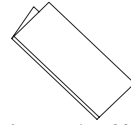

o) 1x Instruction Manual

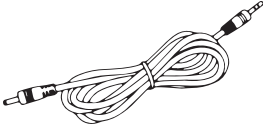

p) 1x Trigger cable



q) 1x Infrared Eye

Mounting the screen

Install the screen at a location visible to all viewers; ideally, the screen should be mounted central to the spectators. The lower third of the screen should be at about eye level of the viewer. The mounting brackets (b) should ideally be installed between 200 and 300mm from each end of the screen. (see Fig. 1)

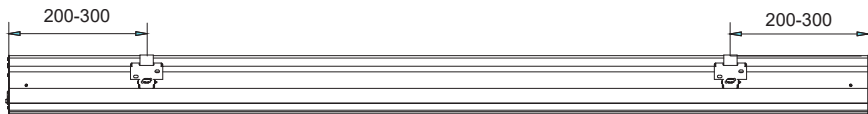

Figure 1

Wall Mounting

1. For mounting on a solid stone / concrete wall please use the heavy-duty dowels (j) or plastic dowels (h). Determine the position for mounting the mounting brackets (b) according to the housing dimensions and the height of the projection screen. Draw a horizontal line (spirit level) to install the two mounting brackets at the same height. (see Fig. 2)

Mounting the screen

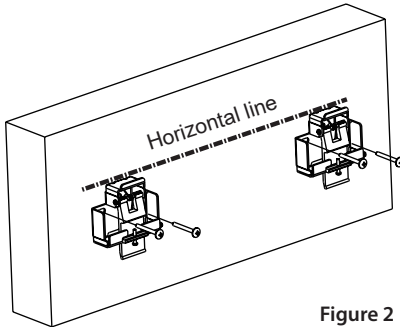

Figure 2

Then drill 2 holes each with an 8mm drill, insert the dowels into the holes and attach the mounting brackets with either the hex nuts (i) or the universal screws (g).

2. Now lift the screen housing with two people and insert it carefully into the mounting bracket. Make sure that the housing engages in the hooks of the mounting brackets. Now slide the housing slowly downwards. The screen should click into place with a click sound. (see Fig.3)

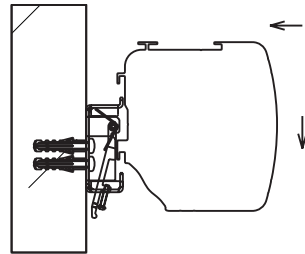

Figure 3

3. Finally tighten the safety screw of the mounting bracket. This prevents inadvertent release of the mounting bracket. (see Fig. 4)

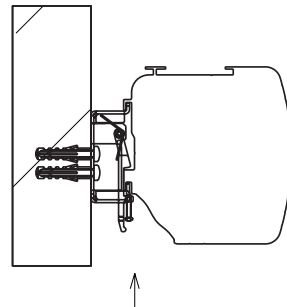

Figure 4

Ceiling mounting (Method 1)

CAUTION: Always ensure that the surface can support the weight of the screen to prevent it from falling and causing an injury.

Mounting the screen

1. For mounting on a solid stone / concrete surface please use the heavy-duty dowels (j) or plastic dowels (h). Determine the position for mounting the mounting brackets (b) according to the housing dimensions and the height of the projection screen. Draw a horizontal line (spirit level) to install the two mounting brackets at the same height. (see Fig. 5)

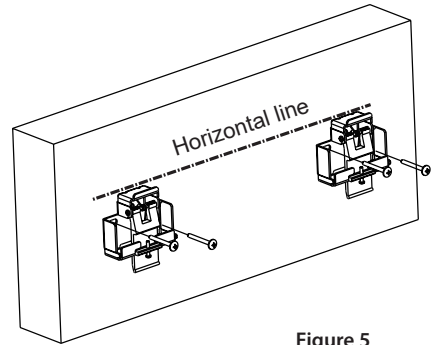

Figure 5

2. Now lift the screen housing with two people and insert it carefully into the mounting bracket. Make sure that the housing engages in the hooks of the mounting brackets. Now push the housing slowly until the screen clicks into place with a click. (see Fig.6)

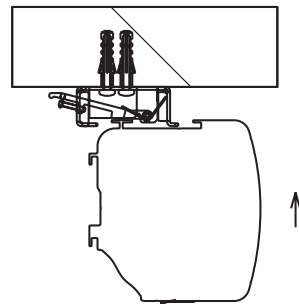

Figure 6

3. Finally tighten the safety screw of the mounting bracket. This prevents inadvertent release of the mounting bracket. (see Fig. 7)

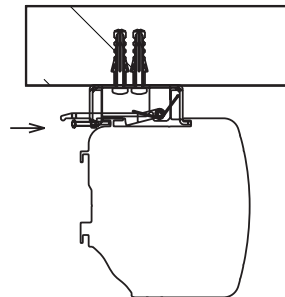

Figure 7

Mounting the screen

Ceiling mounting (method 2)

1. Slide the mounting plates on the top of the screen housing (a) outward. (see Fig. 8)

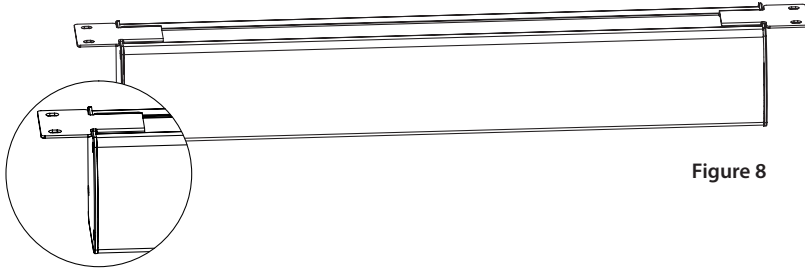

Figure 8

2. For mounting on a solid stone / concrete ceiling, please use heavy-duty dowels (j) or plastic dowels (h). Determine the appropriate position of the screen and transfer hole spacing to your ceiling.

Then drill 2 holes each with an 8mm drill, insert the dowels into the holes and attach the mounting brackets with either the hex nuts (i) or the universal screws (g) depending on the dowel selection (see Fig. 9)

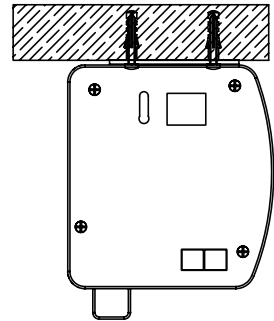

Figure 9

Hanging installation

1. Connect the eyelet (d) to the mounting bracket (b). (see Fig. 10)

2. For mounting on a solid stone / concrete surface, please use heavy-duty dowels (j) or plastic dowels (h). Determine the suitable position for mounting the hook dowel or ceiling hook plate (f). Draw a straight line to install the two hooks in the same alignment. (see Fig. 11)

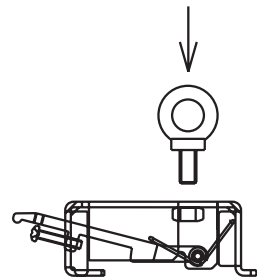

Figure 10

Mounting the screen

3. Attach the mounting brackets (b) to the back of the screen housing and tighten the safety screw.

4. Now hang the screen into the hooks of the previously installed ceiling hook plates.

5. If you require a longer suspension, please use suitable material such as a metal chain (see Fig. 12).

ATTENTION: Please check hanging loads for integrity at least once a year to prevent accidents!

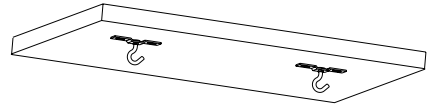

Figure 11

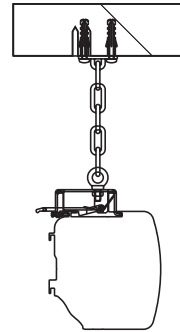
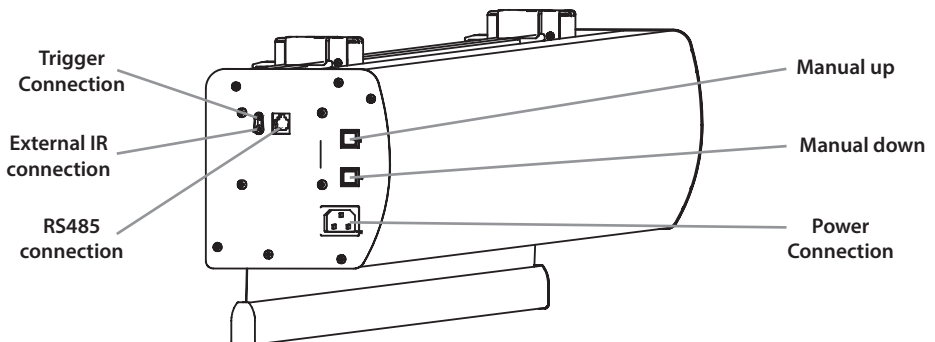

Figure 12

Operation of the screen

Connect the power to the screen with the included power cord. Please pay attention to correct voltage supply (230V / AC). Do not lay the cable on hot surfaces and avoid unnecessary tension.

Screen:



Operation of the screen

Remote control:

The delivery of the screen includes an infrared and a radio remote control. To use the infrared remote control please use the enclosed IR receiver (q). Insert the jack plug into the „ext. IR port,“ on the left side of the screen housing and orient the receiver so that it has visual contact with the IR remote control.



Operating the remote control

- 1) Press the „Up“ button on the remote control. The screen will automatically drive to the upper end position and automatically stop.
- 2) Press the „Stop“ button on the remote control. The movement of the screen stops immediately.
- 3) Press the „Down“ button on the remote control. The screen will automatically drive to the lower end position and automatically stop.

Pairing the radio remote control:

The radio remote control is already paired with the integrated receiver at the factory. If the pairing is forgotten, please proceed as follows:

- 1) Press the „UP“ button for 3 seconds until the LED of the remote control lights up, then connect the power cable to the screen. A beep confirms the pairing mode that has been started.
- 2) Release the „up“ button when you hear the beep.
- 3) Briefly press and release the „up“ button. When the beep sounds 3 times quickly, the remote control pairing is complete.

Trigger:

With the trigger connection, the screen can automatically go up and down when the projector is turned on and off. To do this, connect the screen via the trigger connection to the trigger output of your projector. It may be necessary to enable the trigger output of your projector software so that the projector sends the control signals to the screen. For further information please refer to the operating instructions of your device or contact the manufacturer of the projector.

Input voltage of trigger connection:
DC / AC 5V - DC / AC 20V

Operation of the screen

RS 232/485

A. RS485 port setting

- 1) Baud Rate: 2400
- 2) Data Length: 8
- 3) Odd-even Check: N
- 4) Start Bit: 1
- 5) Stop Bit: 1

B. Control Code

- 1) "Up" Command: 0xFF 0xAA 0xEE 0xEE 0xDD
- 2) "Stop" Command: 0xFF 0xAA 0xEE 0xEE 0xCC
- 3) "Down" Command: 0xFF 0xAA 0xEE 0xEE 0xEE

C. Function Control

- 1) "Up" Command: The screen will go up.
- 2) "Stop" Command: The screen will stop.
- 3) "Down" Command: The screen will go down.

Assignment of the RJ-12 connector:

- 1: RS485-B
- 2: RS485-A
- 3: potential-free contact (Up)
- 4: potential-free contact (stop)
- 5: potential-free contact (down)
- 6: potential-free contact (ground)

IR communication protocol (codes):

Frame format: frame---delay 110ms--- frame

Frame data: 2byte data----delay 43ms----2byte data

Data:

UP: 10110011-01111000 10110100-10000110

STOP: 10110000-11111000 10110111-00000110

DOWN: 10110111-01111000 10110000-10000110

Data from left to right are sent in turn:

„1" bit: 38KHZ carrier wave 246 μ s (10pcs carrier wave), low level :1.76ms

"0" bit: 38KHZ carrier wave 246 μ s (10pcs carrier wave), low level :766 μ s

The remote will always keep sending signals when always hit the button;

Indicator light flashes 1 time per second.

EC Declaration of Conformity

celexon Germany GmbH & Co. KG hereby declares that the product

„DELUXX Cinema Electric Screen (Tension)“

complies with the essential requirements and other relevant regulations

Electromagnetic Compatibility Directive (2014/30 / EU)
The Low Voltage Directive (2014/35 / EU)
and the Radio Equipment Directive (2014/53 / EU)

equivalent. A copy of the EU Declaration of Conformity can be found at
www.deluxx.com/certificates.



A handwritten signature in blue ink, appearing to read 'C. Hertz'.

Christoph Hertz
Managing Director



The symbol indicates the separate take-back of electrical and electronic equipment in EU countries. Please do not dispose of the device in the household waste.

Inform yourself about the return system valid in your country and if you have any questions about the disposal process, please contact your local authority and pollutant collection point.

DE LUXX[®]

celexon Germany GmbH & Co. KG – Gutenberstr. 2 – 48282 Emsdetten, Germany
www.deluxx.com – info@deluxx.com – TEL: +49 221 58834 51